

BA591WS

BAND SWITCHING DIODE

Features

- Very small plastic SMD package
- Low diode capacitance
- Low diode forward resistance
- Small inductance

PINNING

PIN	DESCRIPTION
1	Cathode
2	Anode

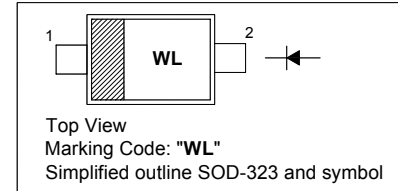

Absolute Maximum Ratings ($T_a = 25\text{ }^\circ\text{C}$)

Parameter	Symbol	Value	Unit
Continuous Reverse Voltage	V_R	35	V
Continuous Forward Current	I_F	100	mA
Power Dissipation	P_{tot}	500	mW
Operating Junction Temperature Range	T_J	- 65 to + 150	$^\circ\text{C}$
Storage Temperature Range	T_s	- 65 to + 150	$^\circ\text{C}$

Electrical Characteristics at $T_a = 25\text{ }^\circ\text{C}$

Parameter	Symbol	Typ.	Max.	Unit
Forward Voltage at $I_F = 10\text{ mA}$	V_F	-	1	V
Reverse Current at $V_R = 20\text{ V}$	I_R	-	20	nA
Diode Capacitance at $V_R = 1\text{ V}$, $f = 1\text{ MHz}$ at $V_R = 3\text{ V}$, $f = 1\text{ MHz}$	C_D	-	1.05 0.9	pF
Diode Forward Resistance at $I_F = 3\text{ mA}$, $f = 100\text{ MHz}$ at $I_F = 10\text{ mA}$, $f = 100\text{ MHz}$	r_D	-	0.7 0.5	Ω
Reverse Resistance at $V_R = 1\text{ V}$, $f = 100\text{ MHz}$	$1/g_p$	100	-	K Ω
Series Inductance	L_s	2	-	nH

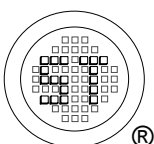

SEMTECH ELECTRONICS LTD.

(Subsidiary of Sino-Tech International Holdings Limited, a company listed on the Hong Kong Stock Exchange, Stock Code: 724)



Dated : 01/09/2006

BA591WS

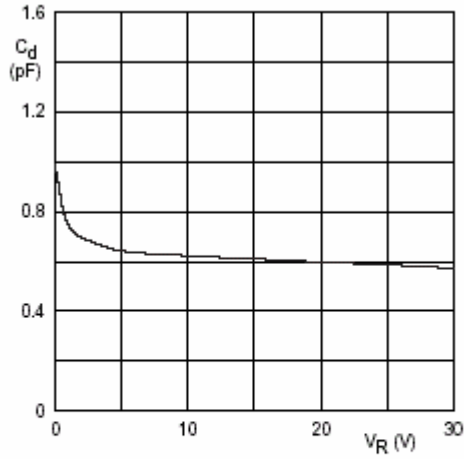

$f = 1 \text{ MHz}; T_j = 25 \text{ }^\circ\text{C}.$

Fig.2 Diode capacitance as a function of reverse voltage; typical values.

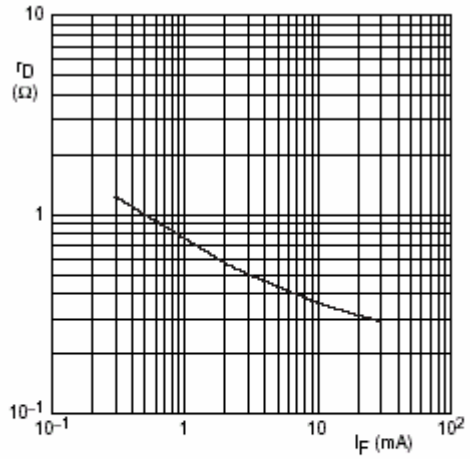

$f = 100 \text{ MHz}; T_j = 25 \text{ }^\circ\text{C}.$

Diode forward resistance as a function of forward current; typical values.

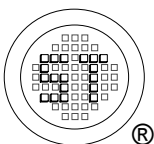

SEMTECH ELECTRONICS LTD.
 (Subsidiary of Sino-Tech International Holdings Limited, a company listed on the Hong Kong Stock Exchange, Stock Code: 724)



Dated : 01/09/2006

BA591WS

PACKAGE OUTLINE

Plastic surface mounted package; 2 leads

SOD-323

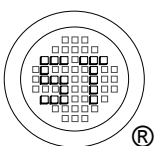
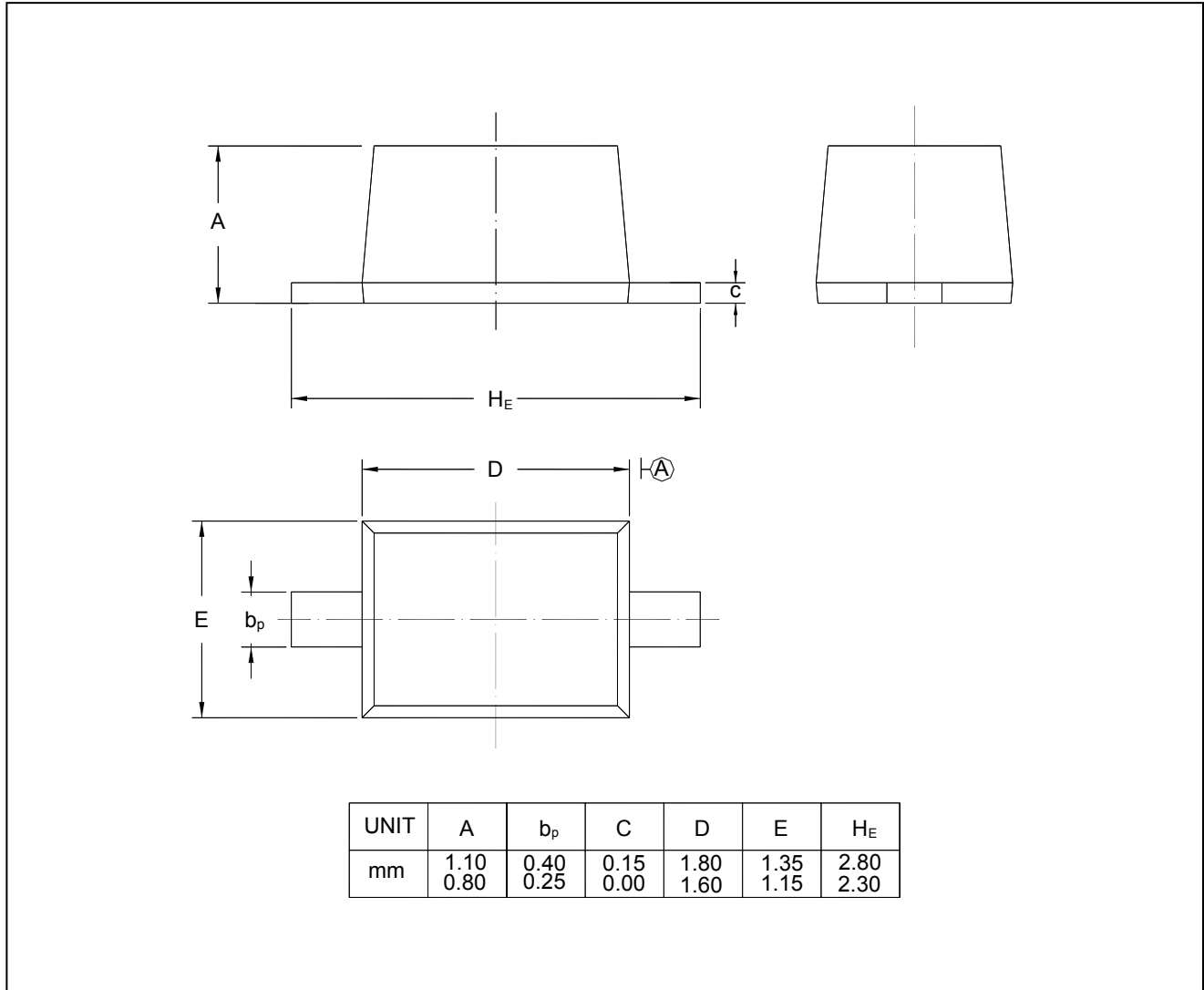

SEMTECH ELECTRONICS LTD.
 (Subsidiary of Sino-Tech International Holdings Limited, a company
 listed on the Hong Kong Stock Exchange, Stock Code: 724)



Dated : 01/09/2006