



UP1853

PNP SILICON TRANSISTOR

HIGH CURRENT (HIGH PERFORMANCE) TRANSISTORS

■ FEATURES

- * 5A Continuous Current , up to 10A peak current
- * Very Low Saturation Voltages
- * Excellent Gain Characteristics Specified up to 10A
- * $P_D = 3W$

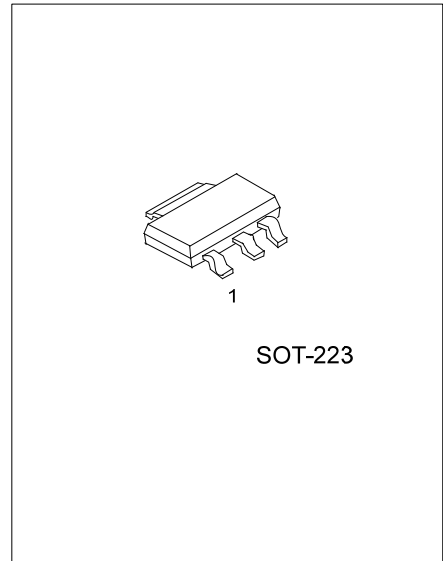

■ ORDERING INFORMATION

Ordering Number		Package	Pin Assignment			Packing
Lead Free	Halogen Free		1	2	3	
UP1853L-AA3-R	UP1853G-AA3-R	SOT-223	B	C	E	Tape Reel

<p>UP1853L-AA3-R</p> <p>(1)Packing Type (2)Package Type (3)Lead Free</p>	<p>(1) R: Tape Reel (2) AA3: SOT-223 (3) G: Halogen Free, L: Lead Free</p>
--	--

■ ABSOLUTE MAXIMUM RATINGS

PARAMETER	SYMBOL	RATINGS	UNIT
Collector-Base Voltage	V_{CBO}	-140	V
Collector-Emitter Voltage	V_{CEO}	-100	V
Emitter-Base Voltage	V_{EBO}	-6	V
Peak Pulse Current	I_{CM}	-10	A
Continuous Collector Current	I_C	-5	A
Power Dissipation ($T_A=25^\circ\text{C}$)	P_D	3	W
Junction Temperature	T_J	+150	$^\circ\text{C}$
Storage Temperature	T_{STG}	-55~+150	$^\circ\text{C}$

Note: Absolute maximum ratings are those values beyond which the device could be permanently damaged. Absolute maximum ratings are stress ratings only and functional device operation is not implied.

■ ELECTRICAL CHARACTERISTICS ($T_A=25^\circ\text{C}$, unless otherwise specified)

PARAMETER	SYMBOL	TEST CONDITIONS	MIN	TYP	MAX	UNIT
Collector-Base Breakdown Voltage	BV_{CBO}	$I_C=-100\mu\text{A}$	-140	-170		V
Collector-Emitter Breakdown Voltage	BV_{CER}	$I_C=-1\mu\text{A}$, $R_B\leq 1\text{K}\Omega$	-140	-170		V
Collector-Emitter Breakdown Voltage	BV_{CEO}	$I_C=-10\text{mA}$ (Note)	-100	-120		V
Emitter-Base Breakdown Voltage	BV_{EBO}	$I_E=-100\mu\text{A}$	-6	-8		V
Collector Cut-Off Current	I_{CBO}	$V_{CB}=-100\text{V}$			-200	nA
Collector Cut-Off Current	I_{CER}	$V_{CB}=-100\text{V}$, $R\leq 1\text{k}\Omega$			-200	nA
Emitter Cut-Off Current	I_{EBO}	$V_{EB}=-6\text{V}$			-50	nA
Collector-Emitter Saturation Voltage	$V_{CE(SAT)}$ (Note)	$I_C=-100\text{mA}$, $I_B=-10\text{mA}$		-20	-50	mV
		$I_C=-1\text{A}$, $I_B=-100\text{mA}$		-90	-115	
		$I_C=-2\text{A}$, $I_B=-200\text{mA}$		-160	-220	
		$I_C=-4\text{A}$, $I_B=-400\text{mA}$		-300	-420	
Base-Emitter Saturation Voltage	$V_{BE(SAT)}$	$I_C=-4\text{A}$, $I_B=-400\text{mA}$ (Note)		-1010	-1170	mV
Base-Emitter Turn-On Voltage	$V_{BE(ON)}$	$I_C=-4\text{A}$, $V_{CE}=-1\text{V}$ (Note)		-925	-1160	mV
DC Current Gain	h_{FE} (Note)	$I_C=-10\text{mA}$, $V_{CE}=-1\text{V}$	100	200		
		$I_C=-1\text{A}$, $V_{CE}=-1\text{V}$	100	200	300	
		$I_C=-3\text{A}$, $V_{CE}=-1\text{V}$	50	90		
		$I_C=-4\text{A}$, $V_{CE}=-1\text{V}$	30	50		
		$I_C=-10\text{A}$, $V_{CE}=-1\text{V}$		15		
Transition Frequency	f_T	$I_C=-100\text{mA}$, $V_{CE}=-10\text{V}$ $f=50\text{MHz}$		125		MHz
Output Capacitance	C_{OB}	$V_{CB}=-10\text{V}$, $f=1\text{MHz}$		65		pF
Switching Times	t_{ON}	$I_C=-2\text{A}$, $I_{B1}=-200\text{mA}$, $I_{B2}=200\text{mA}$,		110		ns
	t_{OFF}	$V_{CC}=-10\text{V}$		460		

Note: Pulse width=300 μs . Duty cycle $\leq 2\%$

TYPICAL CHARACTERISTICS

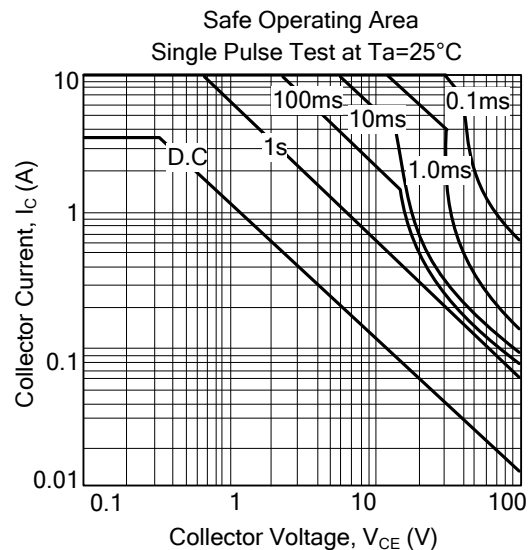
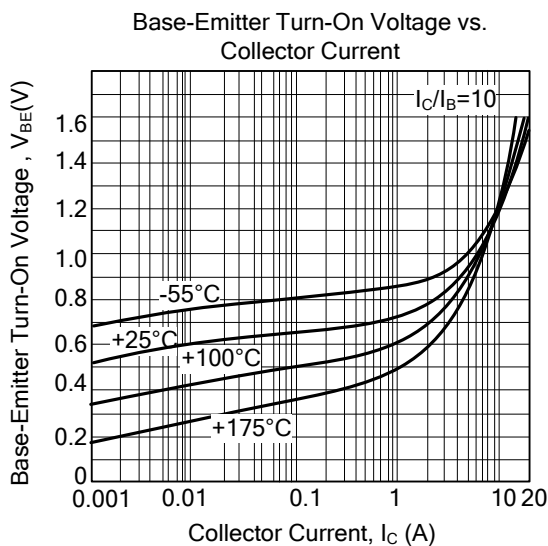
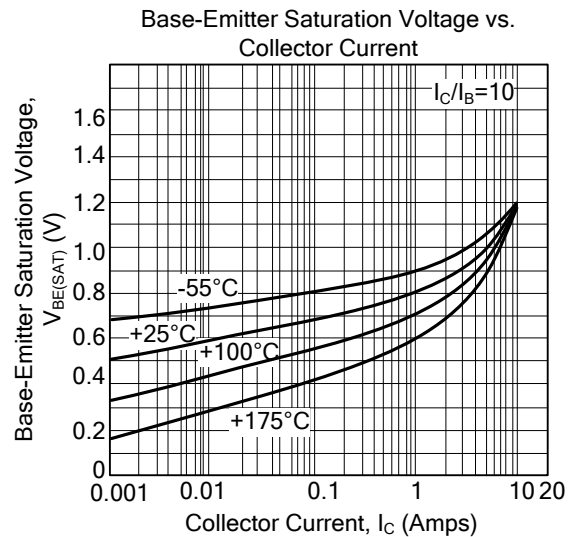
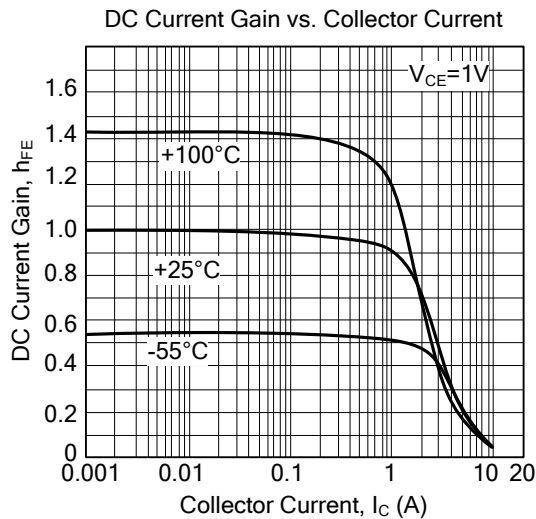
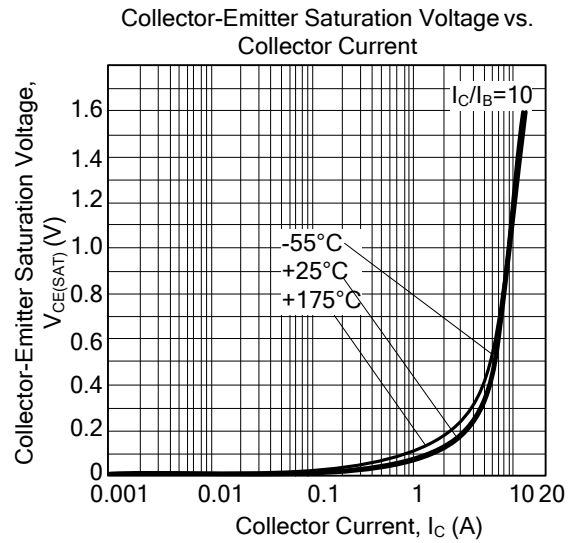
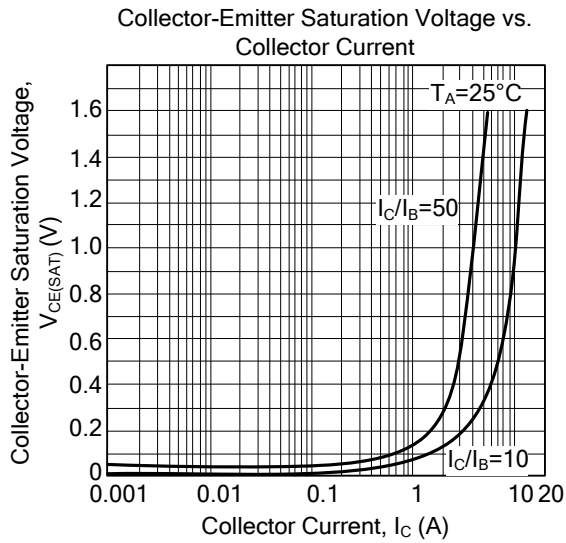

UTC assumes no responsibility for equipment failures that result from using products at values that exceed, even momentarily, rated values (such as maximum ratings, operating condition ranges, or other parameters) listed in products specifications of any and all UTC products described or contained herein. UTC products are not designed for use in life support appliances, devices or systems where malfunction of these products can be reasonably expected to result in personal injury. Reproduction in whole or in part is prohibited without the prior written consent of the copyright owner. The information presented in this document does not form part of any quotation or contract, is believed to be accurate and reliable and may be changed without notice.