

International  
**IR** Rectifier  
**RADIATION HARDENED  
 POWER MOSFET  
 THRU-HOLE (TO-257AA)**

PD - 91400C

**IRHY9130CM  
 JANSR2N7382  
 100V, P-CHANNEL  
 REF: MIL-PRF-19500/615  
 RAD Hard™ HEXFET® TECHNOLOGY**

**Product Summary**

Part Number	Radiation Level	RDS(on)	Id	QPL Part Number
IRHY9130CM	100K Rads (Si)	0.30Ω	-11A	JANSR2N7382
IRHY93130CM	300K Rads (Si)	0.30Ω	-11A	JANSF2N7382

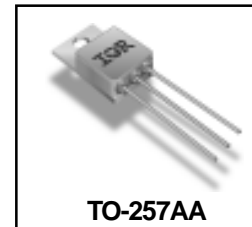

International Rectifier's RADHard HEXFET® technology provides high performance power MOSFETs for space applications. This technology has over a decade of proven performance and reliability in satellite applications. These devices have been characterized for both Total Dose and Single Event Effects (SEE). The combination of low Rds(on) and low gate charge reduces the power losses in switching applications such as DC to DC converters and motor control. These devices retain all of the well established advantages of MOSFETs such as voltage control, fast switching, ease of paralleling and temperature stability of electrical parameters.

**Features:**

- Single Event Effect (SEE) Hardened
- Low RDS(on)
- Low Total Gate Charge
- Proton Tolerant
- Simple Drive Requirements
- Ease of Paralleling
- Hermetically Sealed
- Light Weight

**Absolute Maximum Ratings**

**Pre-Irradiation**

	Parameter		Units
Id @ VGS = -12V, TC = 25°C	Continuous Drain Current	-11	A
Id @ VGS = -12V, TC = 100°C	Continuous Drain Current	-7.0	
IDM	Pulsed Drain Current ①	-44	
PD @ TC = 25°C	Max. Power Dissipation	75	W
	Linear Derating Factor	0.6	W/°C
VGS	Gate-to-Source Voltage	±20	V
EAS	Single Pulse Avalanche Energy ②	150	mJ
IAR	Avalanche Current ①	-11	A
EAR	Repetitive Avalanche Energy ①	7.5	mJ
dv/dt	Peak Diode Recovery dv/dt ③	-16	V/ns
TJ	Operating Junction	-55 to 150	°C
TSTG	Storage Temperature Range		
	Lead Temperature	300 (0.063 in (1.6mm)from case for 10s)	
	Weight	4.3 (Typical)	g

For footnotes refer to the last page

www.irf.com

**Electrical Characteristics @ T<sub>j</sub> = 25°C (Unless Otherwise Specified)**

	Parameter	Min	Typ	Max	Units	Test Conditions
BV <sub>DSS</sub>	Drain-to-Source Breakdown Voltage	-100	—	—	V	V <sub>GS</sub> = 0 V, I <sub>D</sub> = -1.0mA
ΔBV <sub>DSS</sub> /ΔT <sub>J</sub>	Temperature Coefficient of Breakdown Voltage	—	-0.11	—	V/°C	Reference to 25°C, I <sub>D</sub> = -1.0mA
R <sub>DS(on)</sub>	Static Drain-to-Source On-State Resistance	—	—	0.30	Ω	V <sub>GS</sub> = -12V, I <sub>D</sub> = - 7.0A
		—	—	0.35		V <sub>GS</sub> = -12V, I <sub>D</sub> = - 11A ④
V <sub>GS(th)</sub>	Gate Threshold Voltage	-2.0	—	-4.0	V	V <sub>DS</sub> = V <sub>GS</sub> , I <sub>D</sub> = -1.0mA
g <sub>fs</sub>	Forward Transconductance	2.5	—	—	S (τ <sub>s</sub> )	V <sub>DS</sub> > -15V, I <sub>DS</sub> = - 7.0A ④
I <sub>DSS</sub>	Zero Gate Voltage Drain Current	—	—	-25	μA	V <sub>DS</sub> = - 80V, V <sub>GS</sub> = 0V
		—	—	-250		V <sub>DS</sub> = - 80V V <sub>GS</sub> = 0V, T <sub>J</sub> = 125°C
I <sub>GSS</sub>	Gate-to-Source Leakage Forward	—	—	-100	nA	V <sub>GS</sub> = -20V
I <sub>GSS</sub>	Gate-to-Source Leakage Reverse	—	—	100		V <sub>GS</sub> = 20V
Q <sub>g</sub>	Total Gate Charge	—	—	45	nC	V <sub>GS</sub> = -12V, I <sub>D</sub> = - 11A V <sub>DS</sub> = - 50V
Q <sub>gs</sub>	Gate-to-Source Charge	—	—	10		
Q <sub>gd</sub>	Gate-to-Drain ('Miller') Charge	—	—	25		
t <sub>d(on)</sub>	Turn-On Delay Time	—	—	30	ns	V <sub>DD</sub> = - 50V, I <sub>D</sub> = - 11A, R <sub>G</sub> = 7.5Ω
t <sub>r</sub>	Rise Time	—	—	50		
t <sub>d(off)</sub>	Turn-Off Delay Time	—	—	70		
t <sub>f</sub>	Fall Time	—	—	70		
L <sub>S</sub> + L <sub>D</sub>	Total Inductance	—	6.8	—	nH	Measured from drain lead (6mm/0.25in. from package) to source lead (6mm/0.25in. from package)
C <sub>iss</sub>	Input Capacitance	—	1200	—	pF	V <sub>GS</sub> = 0V, V <sub>DS</sub> = - 25V f = 1.0MHz
C <sub>oss</sub>	Output Capacitance	—	310	—		
C <sub>rss</sub>	Reverse Transfer Capacitance	—	80	—		

**Source-Drain Diode Ratings and Characteristics**

	Parameter	Min	Typ	Max	Units	Test Conditions
I <sub>S</sub>	Continuous Source Current (Body Diode)	—	—	-11	A	
I <sub>SM</sub>	Pulse Source Current (Body Diode) ①	—	—	-44		
V <sub>SD</sub>	Diode Forward Voltage	—	—	-3.0	V	T <sub>j</sub> = 25°C, I <sub>S</sub> = - 11A, V <sub>GS</sub> = 0V ④
t <sub>rr</sub>	Reverse Recovery Time	—	—	250	nS	T <sub>j</sub> = 25°C, I <sub>F</sub> = - 11A, di/dt ≤ -100A/μs
Q <sub>RR</sub>	Reverse Recovery Charge	—	—	1.0	μC	V <sub>DD</sub> ≤ - 25V ④
t <sub>on</sub>	Forward Turn-On Time	Intrinsic turn-on time is negligible. Turn-on speed is substantially controlled by L <sub>S</sub> + L <sub>D</sub> .				

**Thermal Resistance**

	Parameter	Min	Typ	Max	Units	Test Conditions
R <sub>thJC</sub>	Junction-to-Case	—	—	1.67	°C/W	Typical socket mount
R <sub>thJA</sub>	Junction-to-Ambient	—	—	80		

**Note:** Corresponding Spice and Saber models are available on the G&S Website.

For footnotes refer to the last page

## Radiation Characteristics

## IRHY9130CM, JANSR2N7382

International Rectifier Radiation Hardened MOSFETs are tested to verify their radiation hardness capability. The hardness assurance program at International Rectifier is comprised of two radiation environments. Every manufacturing lot is tested for total ionizing dose (per notes 5 and 6) using the TO-3 package. Both pre- and post-irradiation performance are tested and specified using the same drive circuitry and test conditions in order to provide a direct comparison.

**Table 1. Electrical Characteristics @ Tj = 25°C, Post Total Dose Irradiation ⑤⑥**

	Parameter	100K Rads(Si) <sup>1</sup>		300K Rads (Si) <sup>2</sup>		Units	Test Conditions
		Min	Max	Min	Max		
BV <sub>DSS</sub>	Drain-to-Source Breakdown Voltage	-100	—	-100	—	V	V <sub>GS</sub> = 0V, I <sub>D</sub> = -1.0mA
V <sub>GS(th)</sub>	Gate Threshold Voltage	- 2.0	- 4.0	-2.0	-5.0		V <sub>GS</sub> = V <sub>DS</sub> , I <sub>D</sub> = -1.0mA
I <sub>GSS</sub>	Gate-to-Source Leakage Forward	—	-100	—	-100	nA	V <sub>GS</sub> = -20V
I <sub>GSS</sub>	Gate-to-Source Leakage Reverse	—	100	—	100		V <sub>GS</sub> = 20 V
I <sub>DSS</sub>	Zero Gate Voltage Drain Current	—	-25	—	-25	μA	V <sub>DS</sub> =-80V, V <sub>GS</sub> =0V
R <sub>DS(on)</sub>	Static Drain-to-Source ④ On-State Resistance (TO-3)	—	0.30	—	0.30	Ω	V <sub>GS</sub> = -12V, I <sub>D</sub> =-7.0A
R <sub>DS(on)</sub>	Static Drain-to-Source ④ On-State Resistance (TO-257AA)	—	0.30	—	0.30	Ω	V <sub>GS</sub> = -12V, I <sub>D</sub> =-7.0A
V <sub>SD</sub>	Diode Forward Voltage ④	—	-3.0	—	-3.0	V	V <sub>GS</sub> = 0V, I <sub>S</sub> = -11A

1. Part number IRHY9130CM (JANSR2N7382)

2. Part number IRHY93130CM (JANSF2N7382)

International Rectifier radiation hardened MOSFETs have been characterized in heavy ion environment for Single Event Effects (SEE). Single Event Effects characterization is illustrated in Fig. a and Table 2.

**Table 2. Single Event Effect Safe Operating Area**

Ion	LET MeV/(mg/cm <sup>2</sup> )	Energy (MeV)	Range (μm)	VDS (V)				
				@VGS=0V	@VGS=5V	@VGS=10V	@VGS=15V	@VGS=20V
Cu	28	285	32.6	-100	-100	-100	-70	-60
Br	36.8	305	39	-100	-100	-70	-50	-40
I	59.8	343	43	-60	—	—	—	—

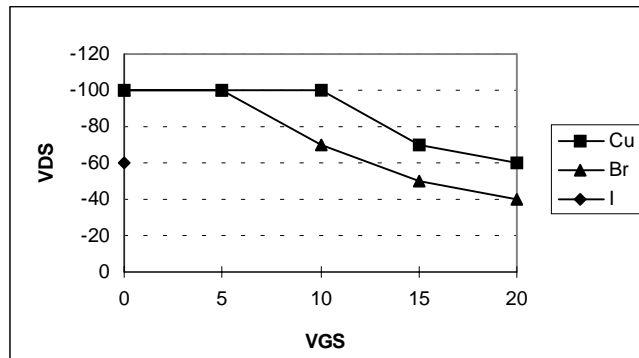

**Fig a. Single Event Effect, Safe Operating Area**

For footnotes refer to the last page

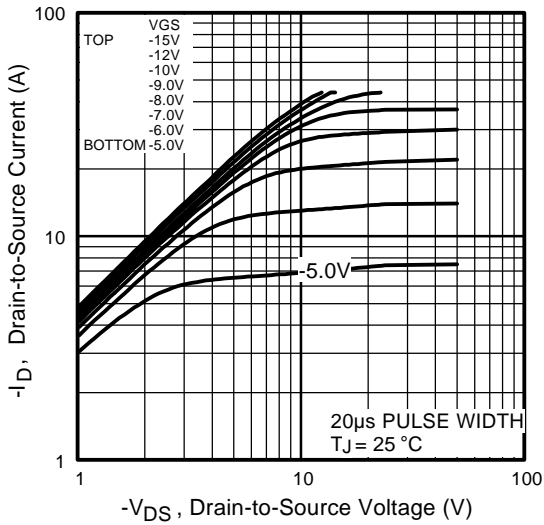

Fig 1. Typical Output Characteristics

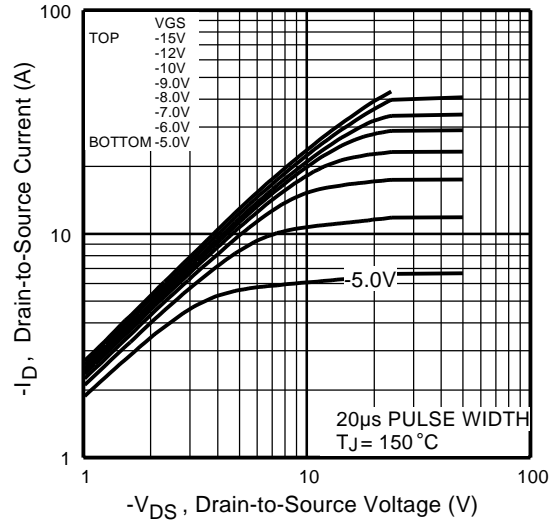

Fig 2. Typical Output Characteristics

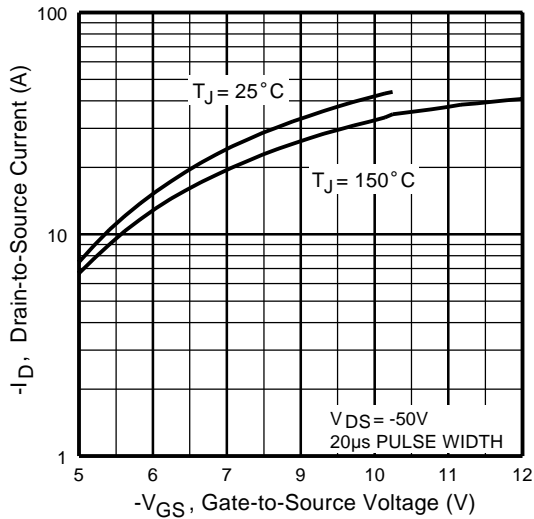

Fig 3. Typical Transfer Characteristics

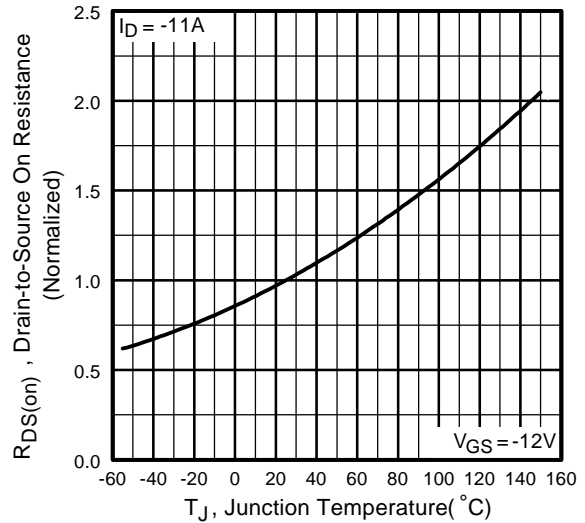

Fig 4. Normalized On-Resistance Vs. Temperature

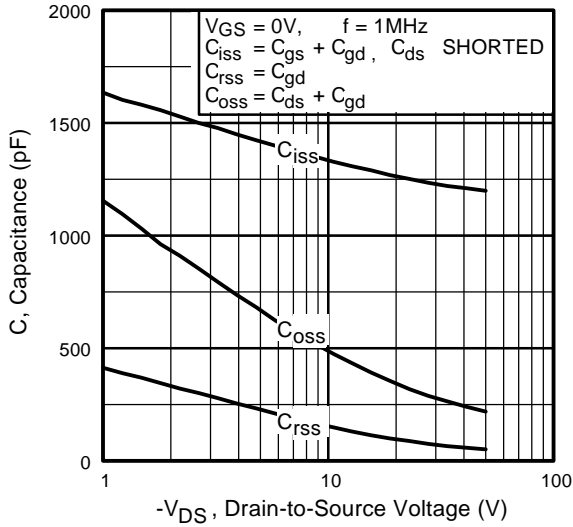

Fig 5. Typical Capacitance Vs. Drain-to-Source Voltage

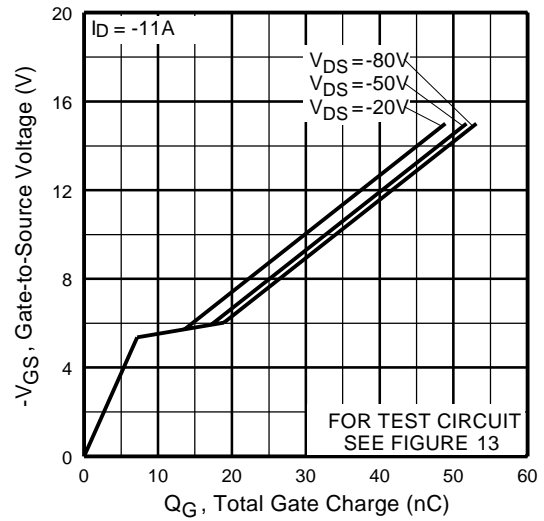

Fig 6. Typical Gate Charge Vs. Gate-to-Source Voltage

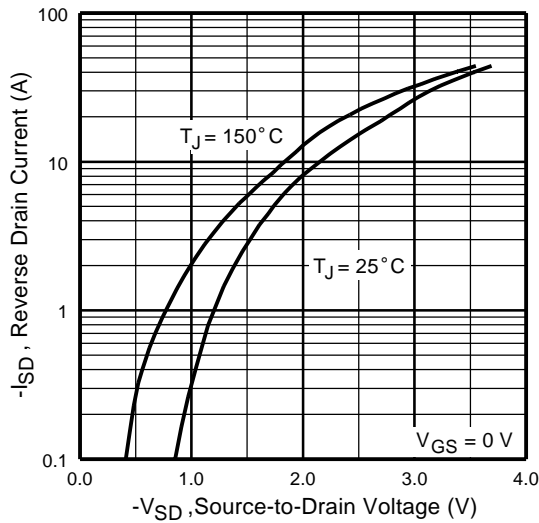

Fig 7. Typical Source-Drain Diode Forward Voltage

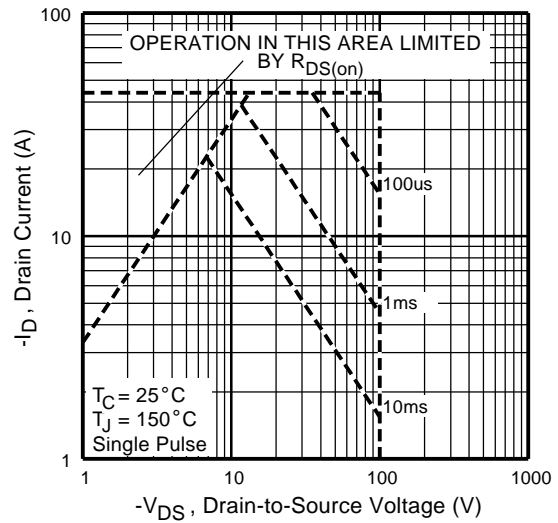
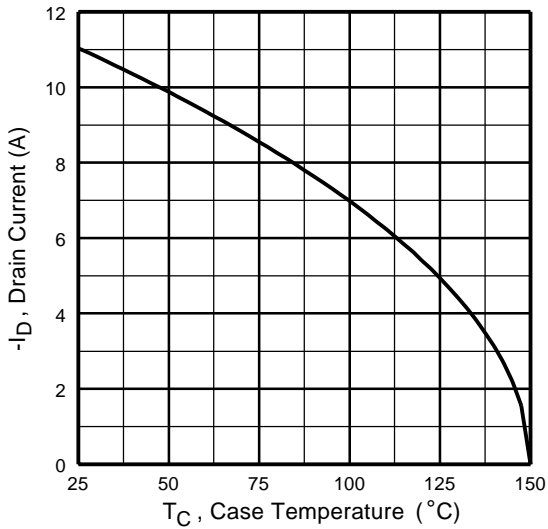
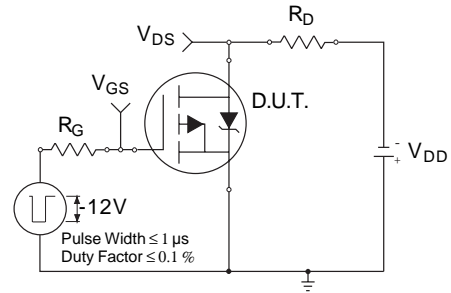

Fig 8. Maximum Safe Operating Area



**Fig 9.** Maximum Drain Current Vs. Case Temperature



**Fig 10a.** Switching Time Test Circuit

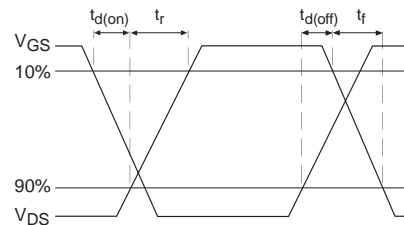

**Fig 10b.** Switching Time Waveforms

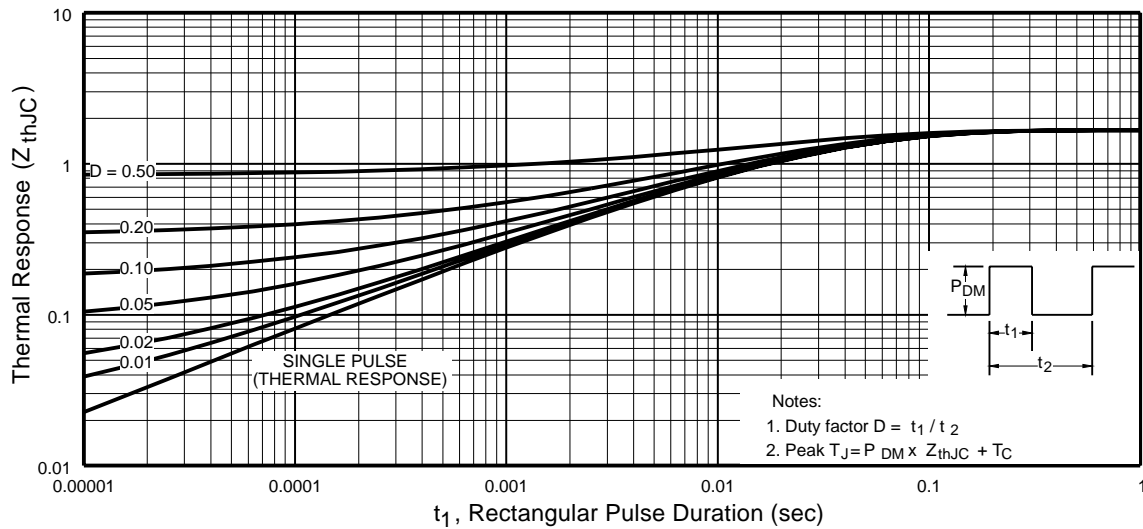

**Fig 11.** Maximum Effective Transient Thermal Impedance, Junction-to-Case

Pre-Irradiation

IRHY9130CM, JANSR2N7382

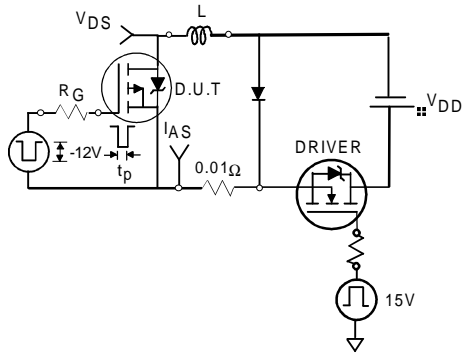

Fig 12a. Unclamped Inductive Test Circuit

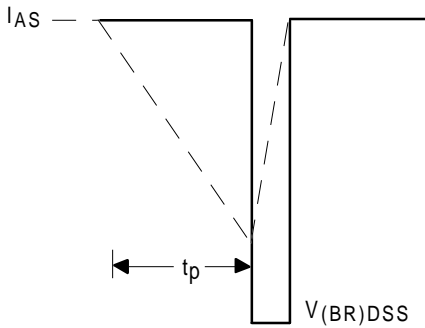

Fig 12b. Unclamped Inductive Waveforms

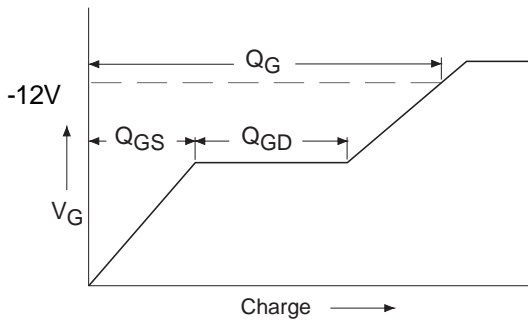

Fig 13a. Basic Gate Charge Waveform

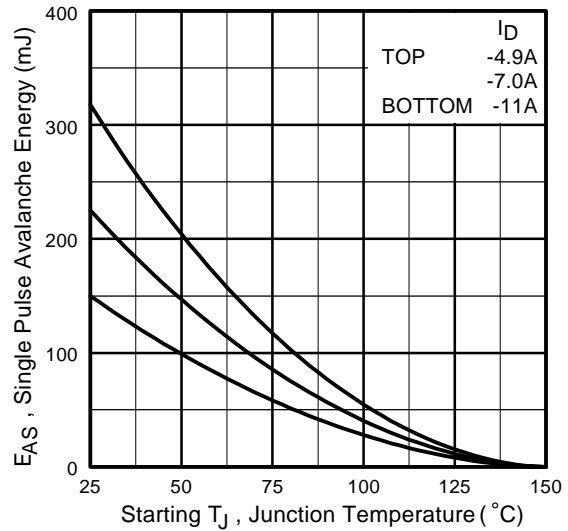

Fig 12c. Maximum Avalanche Energy Vs. Drain Current

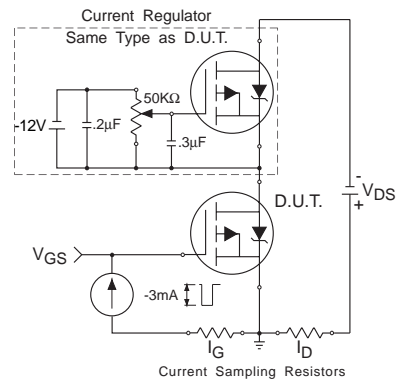
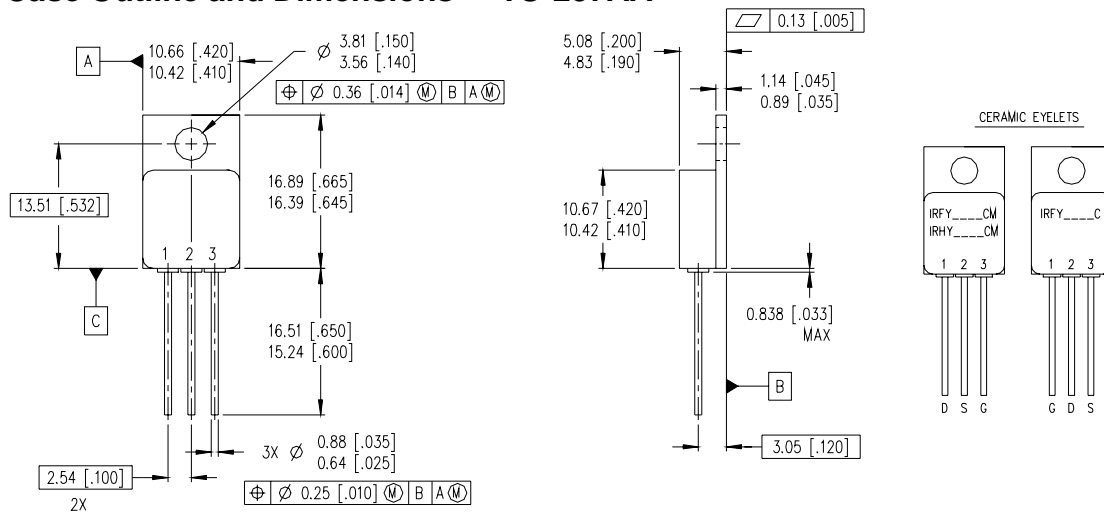

Fig 13b. Gate Charge Test Circuit

**Foot Notes:**

- ① Repetitive Rating; Pulse width limited by maximum junction temperature.
- ②  $V_{DD} = -25V$ , starting  $T_J = 25^\circ C$ ,  $L = 2.4mH$   
Peak  $I_L = -11A$ ,  $V_{GS} = -12V$
- ③  $I_{SD} \leq -11A$ ,  $di/dt \leq -440A/\mu s$ ,  
 $V_{DD} \leq -100V$ ,  $T_J \leq 150^\circ C$
- ④ Pulse width  $\leq 300 \mu s$ ; Duty Cycle  $\leq 2\%$
- ⑤ **Total Dose Irradiation with  $V_{GS}$  Bias.**  
-12 volt  $V_{GS}$  applied and  $V_{DS} = 0$  during irradiation per MIL-STD-750, method 1019, condition A.
- ⑥ **Total Dose Irradiation with  $V_{DS}$  Bias.**  
-80 volt  $V_{DS}$  applied and  $V_{GS} = 0$  during irradiation per MIL-STD-750, method 1019, condition A.

**Case Outline and Dimensions — TO-257AA**



**NOTES:**

1. DIMENSIONING & TOLERANCING PER ANSI Y14.5M-1994.
2. CONTROLLING DIMENSION: INCH.
3. DIMENSIONS ARE SHOWN IN MILLIMETERS [INCHES].
4. OUTLINE CONFORMS TO JEDEC OUTLINE TO-257AA.

**LEGEND**

- D - DRAIN
- S - SOURCE
- G - GATE

International  
**IOR** Rectifier

IR WORLD HEADQUARTERS: 233 Kansas St., El Segundo, California 90245, USA Tel: (310) 252-7105  
TAC Fax: (310) 252-7903

Visit us at [www.irf.com](http://www.irf.com) for sales contact information.  
Data and specifications subject to change without notice. 06/02