

SK 80 D 12 F

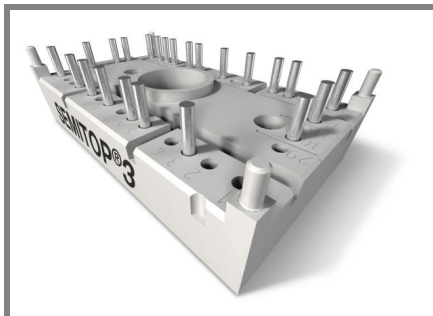

SEMITOP® 3

Bridge Rectifier

SK 80 D 12 F

Preliminary Data

Features

- Compact design
- One screw mounting
- Heat transfer and insulation through direct copper bonded aluminium oxide ceramic (DCB)
- Fast and soft recovery CAL (Controlled Axial Lifetime) diode
- UL recognized, file no. E 63 532

Typical Applications*

- General power switching applications
- UPS
- SMPS

V_{RSM} V	V_{RRM}, V_{DRM} V	$I_D = 80$ A (full conduction) ($T_s = 80$ °C)
	1200	SK 80 D 12 F

Symbol	Conditions	Values	Units
I_D	$T_s = 80$ °C	80	A
I_{RRM}	$T_{vj} = 125$ °C (See Fig. 6)	typ. 40	A
Q_{rr}	$T_{vj} = 25$ (125) °C (See Fig. 6)	typ. 3 (8)	μC
I_R	$T_{vj} = 25$ (150) °C; $V_R = V_{RRM}$	0,2 (4)	mA
I_{FSM}	$T_{vj} = 150$ °C; 10 ms	550	A
i^2t	$T_{vj} =$ °C; ms		A
	$T_{vj} = 150$ °C; 10 ms	1500	A ² s
	$T_{vj} =$ °C; ms		A ² s
V_F	$T_{vj} = 25$ °C; $I_F = 75$ A	max. 2,5	V
$V_{(TO)}$	$T_{vj} = 125$ °C	max. 1,2	V
r_T	$T_{vj} = 125$ °C	max. 22	mΩ
I_{RD}	$T_{vj} =$ °C; $V_{DD} = V_{DRM}$; $V_{RD} = V_{RRM}$		mA
			mA
$R_{th(j-s)}$	per diode	0,9	K/W
	per module	0,15	K/W
T_{solder}	terminals, 10s	260	°C
T_{vj}		-40...+150	°C
T_{stg}		-40...+125	°C
V_{isol}	a. c. 50 Hz; r.m.s.; 1 s / 1 min.	3000 (2500)	V
M_s	mounting torque to heatsink	2,5	Nm
M_t			
m	approx. weight	30	g
Case	SEMITOP® 3	T 25	



D

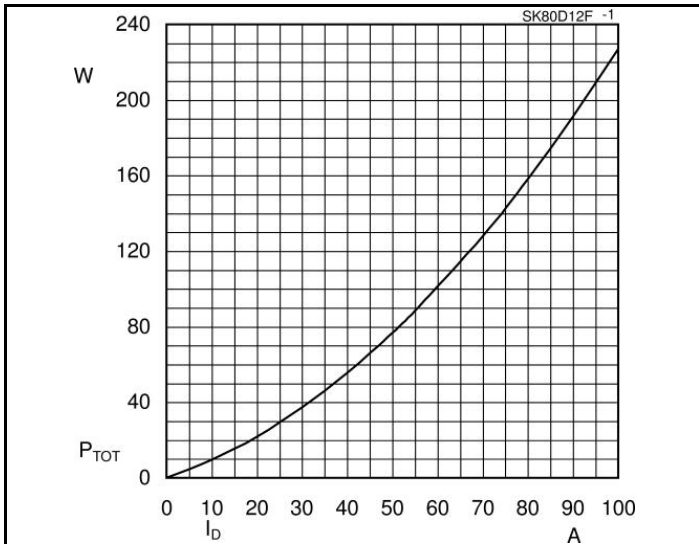

Fig. 1 Power dissipation vs. Output current

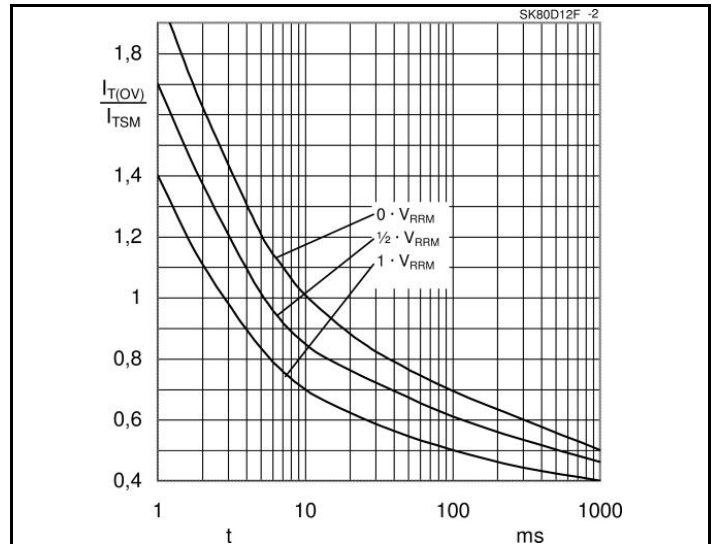

Fig. 2 Surge overload current vs. time

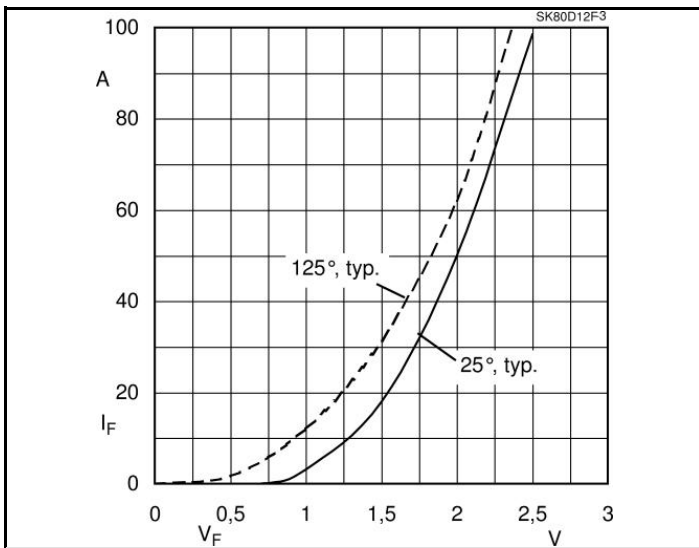

Fig. 3 Forward characteristics of single diode

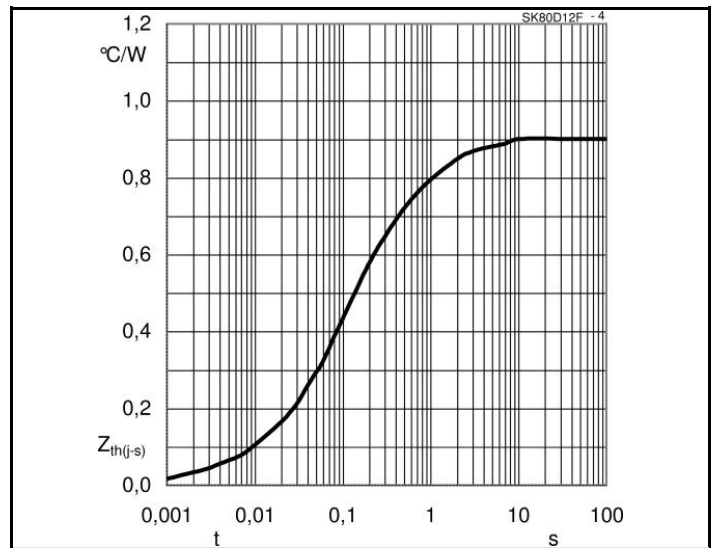

Fig. 4 Thermal transient impedance vs. time

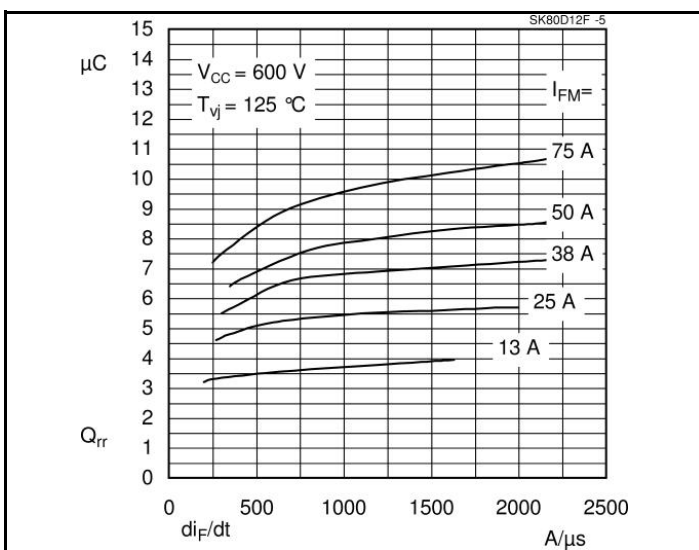

Fig. 5 Typ. reverse recovery charge $Q_{rr} = f(di_F/dt)$

Measurement conditions for switching parameters:

$I_F = 50A$
 $V_R = 600V$
 $-di/dt = 800A/\mu s$

Fig. 6

SK 80 D 12 F

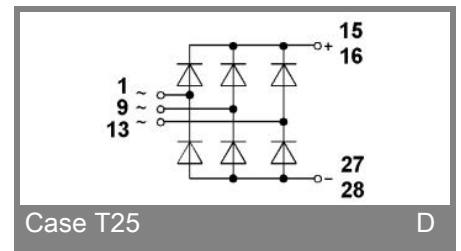
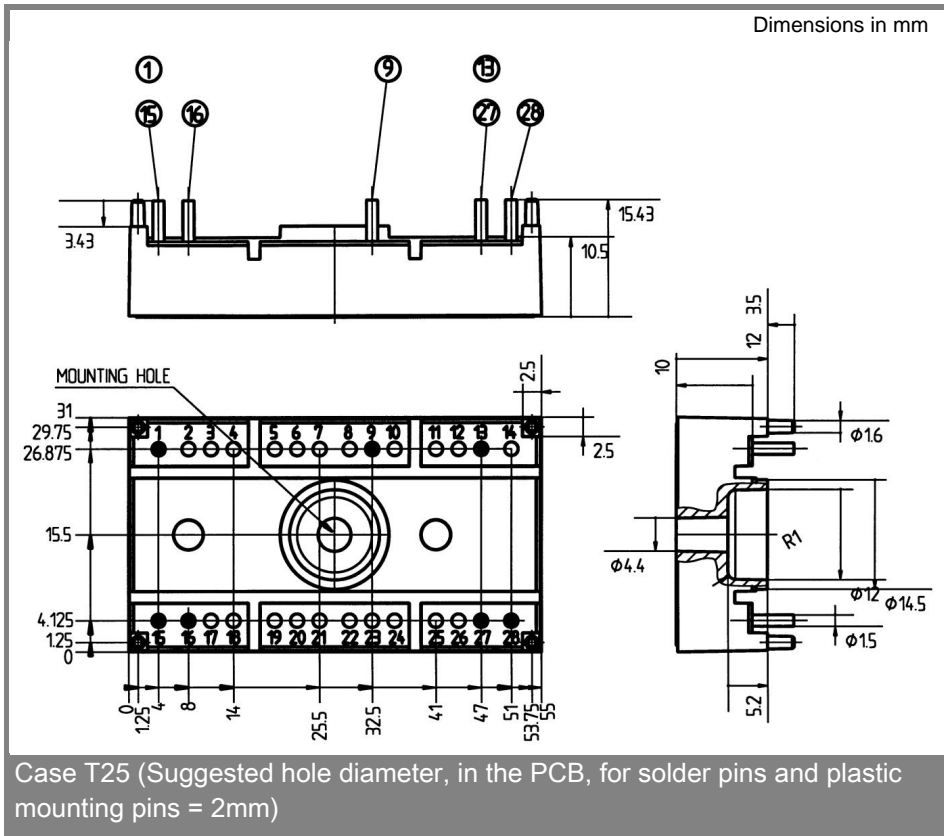

* The specifications of our components may not be considered as an assurance of component characteristics. Components have to be tested for the respective application. Adjustments may be necessary. The use of SEMIKRON products in life support appliances and systems is subject to prior specification and written approval by SEMIKRON. We therefore strongly recommend prior consultation of our personal.