

FEATURES/BENEFITS

- Latest generation of High Voltage IGBT Technology
- Innovative isolated driver ensures fast power transistor turn on and off and thus low power transient
- Ultra low output leakage current
- Low control current consumption
- Triggered control input to avoid linear control risks
- Low conducted and radiated disturbances



Part Number	Description
SI60DC100	100A, 600 Vdc Solid-State Relay
SI120DC50	50A, 1200 Vdc Solid-State Relay
SI170DC25	25A, 1700 Vdc Solid-State Relay

Part Number Explanation

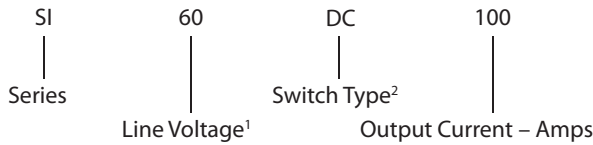

NOTES

- 1) Line Voltage (peak): 60 = 600 Vdc; 120 = 1200 Vdc; 170 = 1700 Vdc;
- 2) Switch Type: DC = DC

ELECTRICAL SPECIFICATIONS

(+25°C ambient temperature unless otherwise specified)

INPUT (CONTROL) SPECIFICATIONS

	Min	Max	Units
Control Range	4.5	32	Vdc
Input Current Range	25	42	mAdc
Typical Turn-On Voltage	3.5		Vdc
Must Turn-Off Voltage	1		Vdc
Reverse Voltage		32	Vdc
Reverse Leakage Current		1	mA

CONTROL CHARACTERISTIC

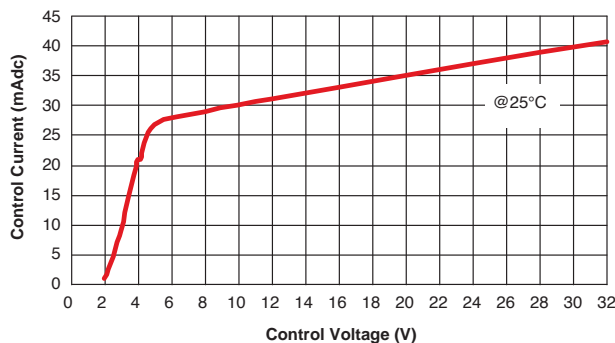
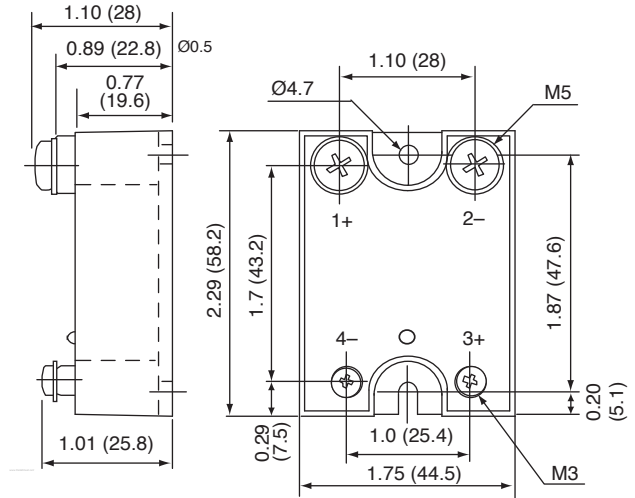

Figure 2

MECHANICAL SPECIFICATION



Tolerances: Ø0.3
 Dimensions in inches (mm)
 Weight: 3.52 oz. (100g)

Figure 1

BLOCK DIAGRAM

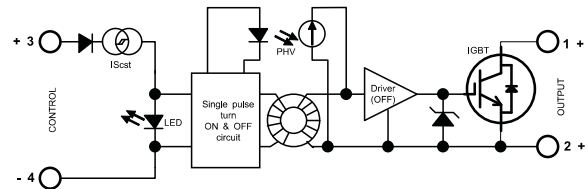

Figure 3

ELECTRICAL SPECIFICATIONS
(+25°C ambient temperature unless otherwise specified)

OUTPUT (LOAD) SPECIFICATIONS

	Min	Max	Units
Operating Range			
SI60DC100	0	500	Vdc
SI120DC50	0	1000	Vdc
SI170DC25	0	1400	Vdc
Peak Voltage			
SI60DC100		600	Vpeak
SI120DC50		1200	Vpeak
SI170DC25		1700	Vpeak
Reverse Voltage (Internal Diode)			
SI60DC100		1.4	V
SI120DC50		1.4	V
SI170DC25		3.3	V
Maximum Nominal Current (Resistive)			
SI60DC100		100	A
SI120DC50		50	A
SI170DC25		25	A
Maximum Peak Current Rating (Non-Repetitive) (ON-State)			
SI60DC100		550	A
SI120DC50		320	A
SI170DC25		40	A
Leakage Current			
SI60DC100		1	mA
SI120DC50		1	mA
SI170DC25		1.5	mA
Max On-State Voltage Drop			
	@25 °C	@125 °C	
SI60DC100	1.35	1.45	V
SI120DC50	1.5	1.7	V
SI170DC25	3.3	3.3	V
Output Capacitance (Typical)			
SI60DC100		300	pF
SI120DC50		300	pF
SI170DC25		90	pF
Junction-Case Thermal Resistance			
SI60DC100		.385	°C/W
SI120DC50		.365	°C/W
SI170DC25		1.25	°C/W

ELECTRICAL SPECIFICATIONS (Continued)
(+25°C ambient temperature unless otherwise specified)

OUTPUT (LOAD) SPECIFICATIONS

	Min	Max	Units
Built-In Heat Sink Thermal Resistance (Vertically Mounted)			
		10	°C/W
Heat Sink Thermal Time Constant			
		10	min
Control Inputs/Power Outputs			
Insulation Voltage		4	kV
Turn-On Time		10	µs
Turn-On Delay		600	µs
Turn-Off Time			
SI60DC100		10	µs
SI120DC50		50	µs
SI170DC25		50	µs
Turn-Off Delay		100	µs
On-Off Frequency			
SI60DC100		700	Hz
SI120DC50		200	Hz
SI170DC25		200	Hz

TIME DIAGRAMS

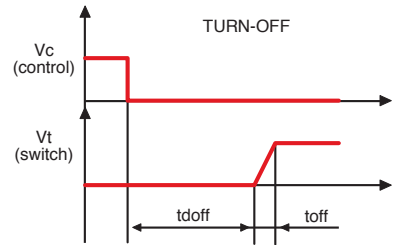
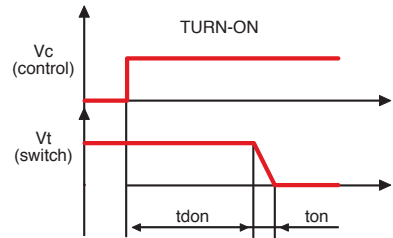

Figure 4

GENERAL SPECIFICATIONS
(+25°C ambient temperature unless otherwise specified)

ENVIRONMENTAL SPECIFICATIONS

	Min	Max	Units
Operating Temperature	-40	+90	°C
Storage Temperature	-40	+100	°C
Input-Output Isolation	4000		Vrms
Insulation Resistance	1		GΩ
Insulation Capacitance	< 8		pF
Junction Temperature		100	°C

CONNECTIONS

	Power	Control
Screwdriver	Phillips NR2	Phillips NR1
Tightening Torque	1.8 N.m	0.8 N.m
Insulated crimp terminals (Round Tabs, Eyelet Type)	M5	M3

MISCELLANEOUS

Display	Green LED (ON)
Housing	UL94V0
Mounting	2 screws (M4x12mm)
Noise Level	No audible noise

GENERAL

Standards	IEC60947-1
Protection Level	IP00
Protection Against Direct Touch	None
CE Marking	Yes

E.M.C. EMISSION

Radiated & Conducted Disturbances	NFEN55011
-----------------------------------	-----------

HIGH SIDE WIRING DIAGRAM
(Load Connected to “-”)

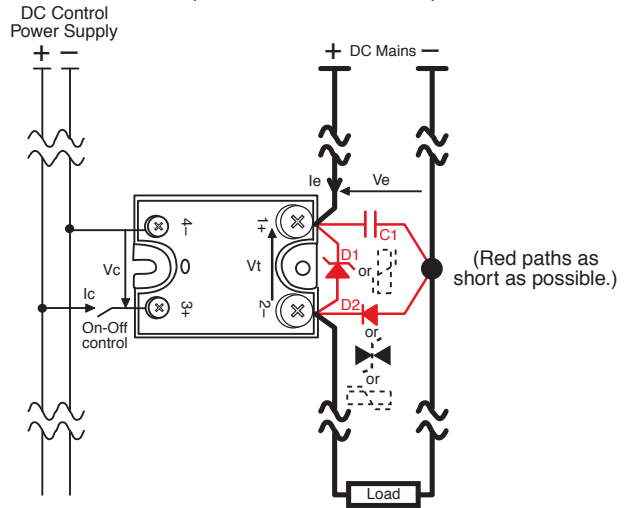

Figure 5

LOW SIDE WIRING DIAGRAM
(Load Connected to “+”)

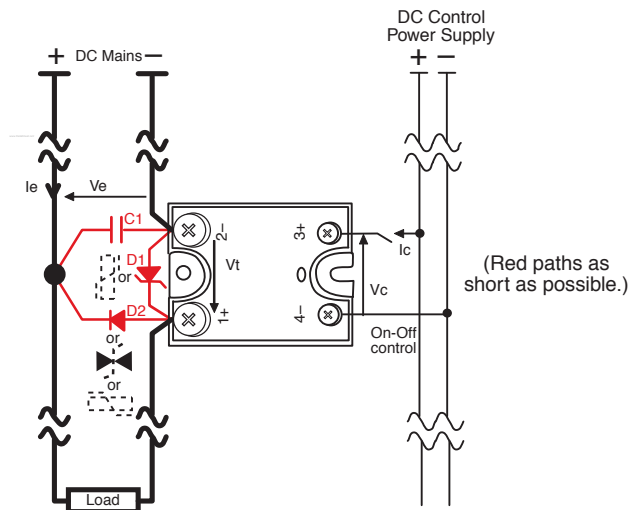

Figure 6

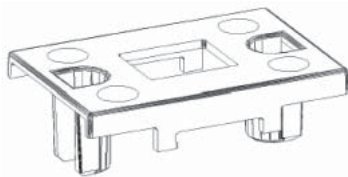

Figure 7

PROTECTIVE COVER AVAILABLE
Contact Factory

OUTPUT RELAY CHARACTERISTIC CURVES FOR SI60DC100

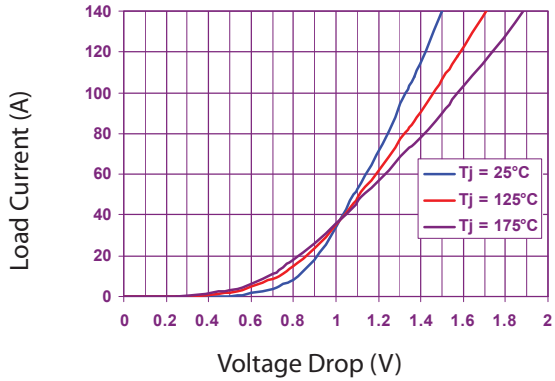

Figure 8a

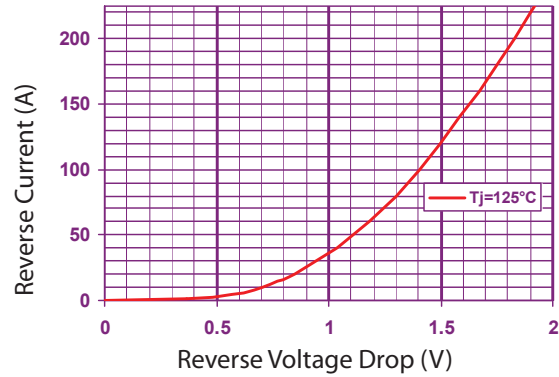

Figure 8b

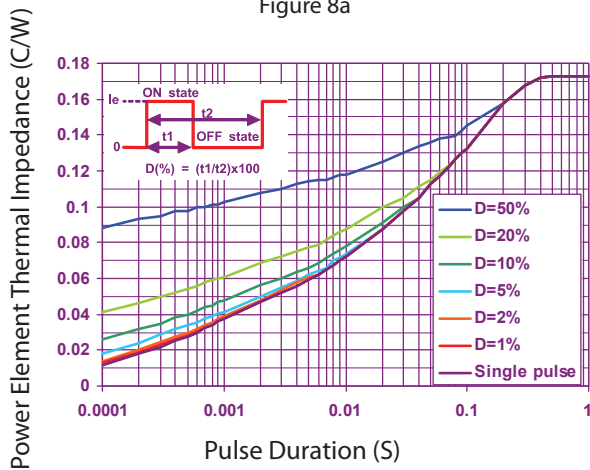

Figure 8c

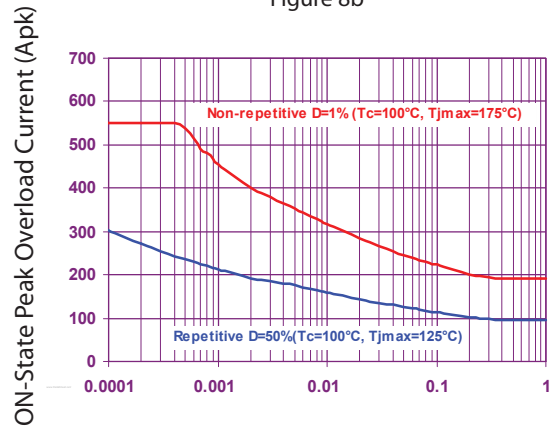
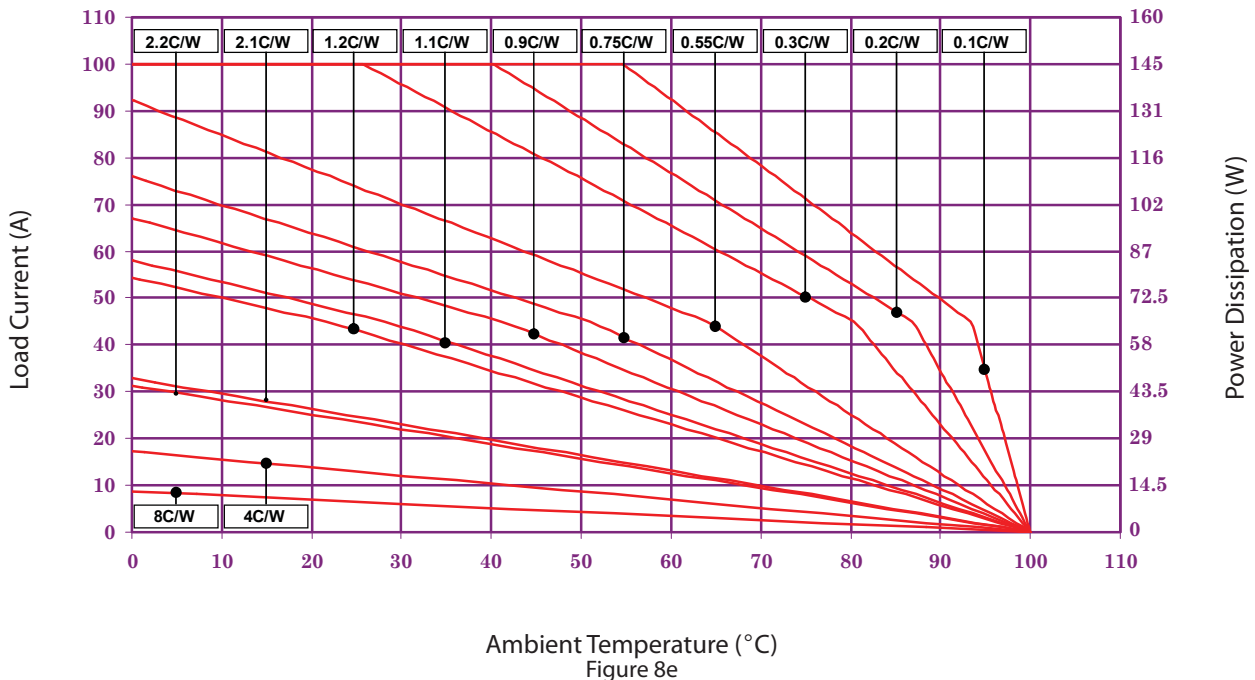

Figure 8d



Ambient Temperature (°C)
Figure 8e

OUTPUT RELAY CHARACTERISTIC CURVES FOR SI120DC50

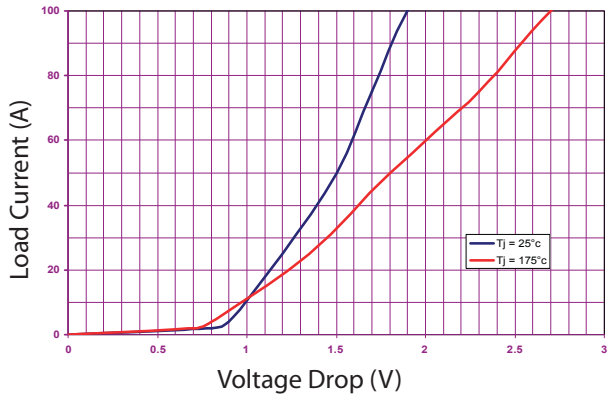

Figure 9a

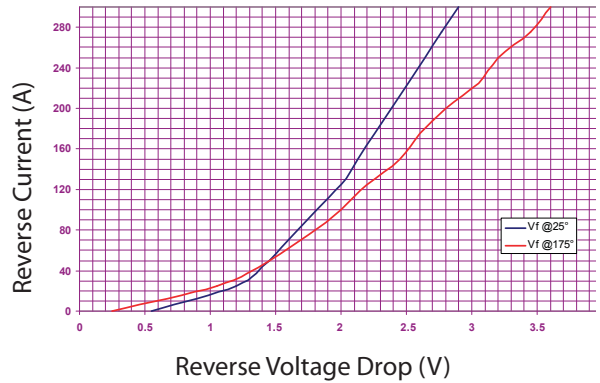

Figure 9b

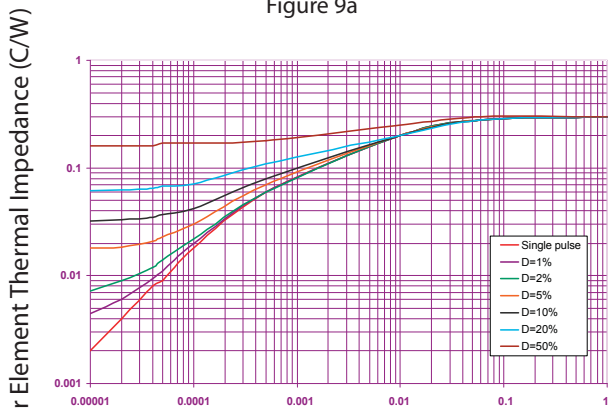

Figure 9c

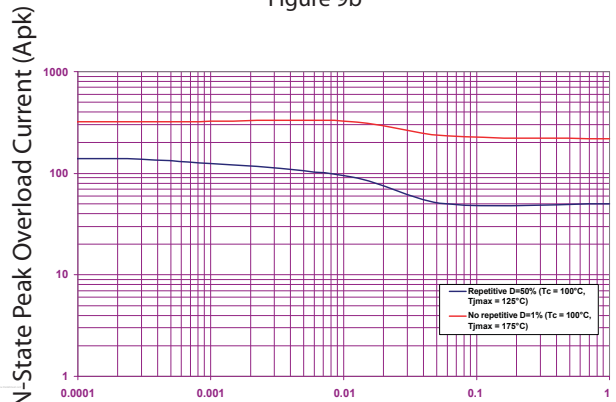

Figure 9d

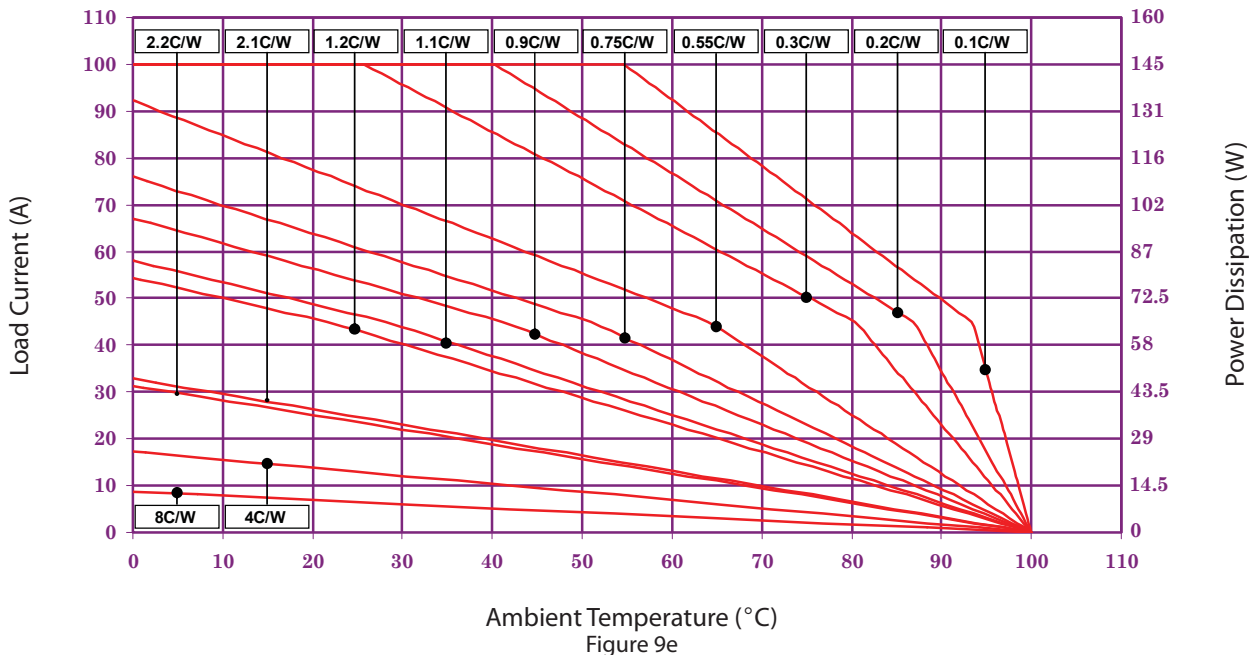
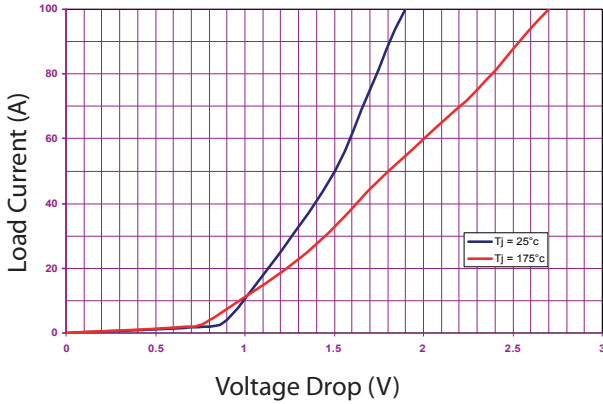
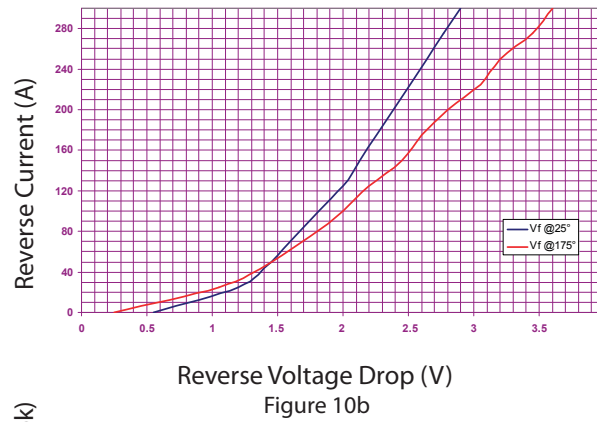

Figure 9e

OUTPUT RELAY CHARACTERISTIC CURVES FOR SI170DC25



Voltage Drop (V)
Figure 10a



Reverse Voltage Drop (V)
Figure 10b

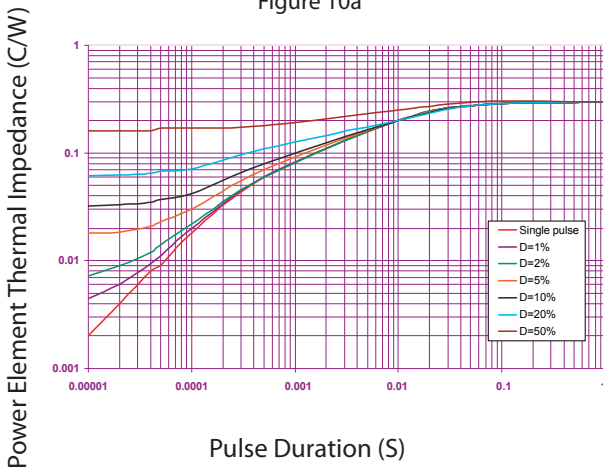

Pulse Duration (S)
Figure 10c

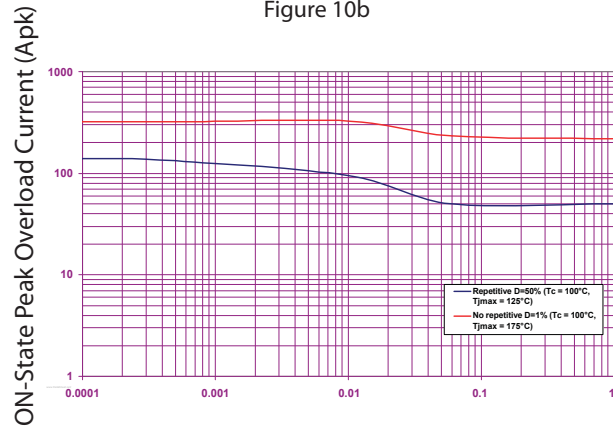

Pulse Duration (S)
Figure 10d

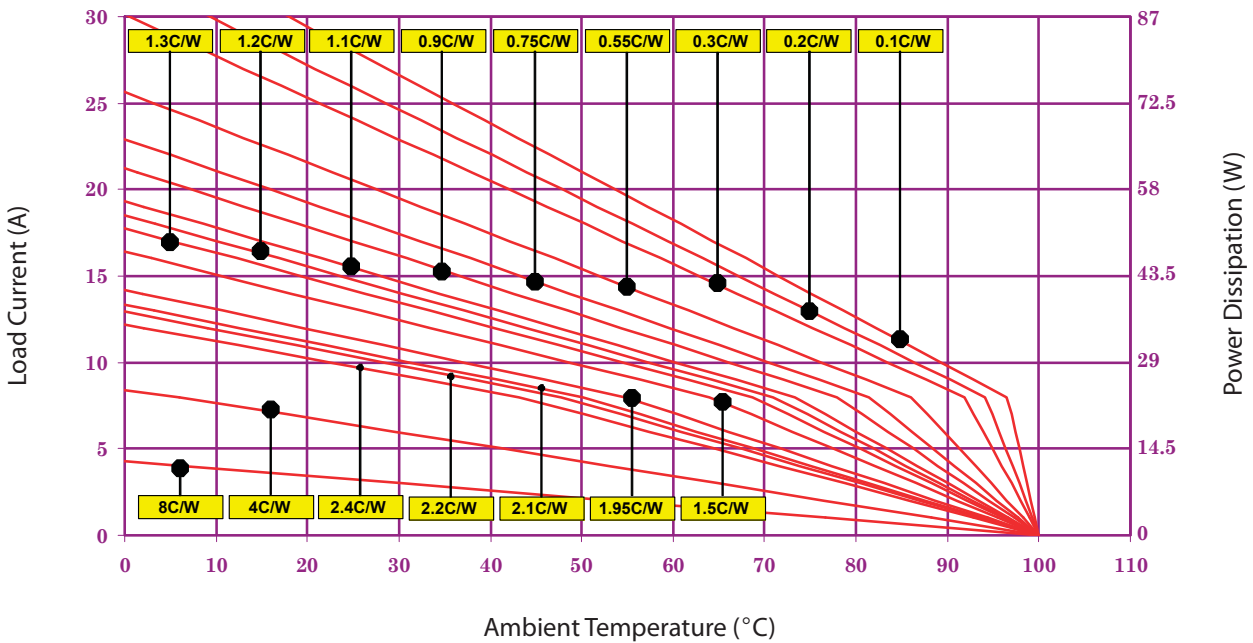

Figure 10e

NOTES
1. For additional/custom options, contact factory.