

ADD-A-PAK Generation VII Power Modules Schottky Rectifier, 400 A



ADD-A-PAK

FEATURES

- 175 °C T_J operation
- Low forward voltage drop
- High frequency operation
- Low thermal resistance
- UL pending
- Compliant to RoHS directive 2002/95/EC
- Designed and qualified for industrial level

RoHS
COMPLIANT

PRODUCT SUMMARY

$I_{F(AV)}$	400 A
-------------	-------

MECHANICAL DESCRIPTION

The ADD-A-PAK generation VII, new generation of ADD-A-PAK module, combines the excellent thermal performances obtained by the usage of exposed direct bonded copper substrate, with advanced compact simple package solution and simplified internal structure with minimized number of interfaces.

BENEFITS

- Excellent thermal performances obtained by the usage of exposed direct bonded copper substrate
- High surge capability
- Easy mounting on heatsink

ELECTRICAL DESCRIPTION

The VSKCS403.. Schottky rectifier common cathode has been optimized for low reverse leakage at high temperature. The proprietary barrier technology allows for reliable operation up to 175 °C junction temperature.

Typical applications are in high current switching power supplies, plating power supplies, UPS systems, converters, freewheeling diodes, welding, and reverse battery protection.

MAJOR RATINGS AND CHARACTERISTICS

SYMBOL	CHARACTERISTICS	VALUES	UNITS
$I_{F(AV)}$	Rectangular waveform	400	A
V_{RRM}		100	V
I_{FSM}	$t_p = 5 \mu s$ sine	25 500	A
V_F	200 Apk, $T_J = 125 \text{ }^\circ\text{C}$	0.83	V
T_J	Range	- 55 to 175	$^\circ\text{C}$

VOLTAGE RATINGS

PARAMETER	SYMBOL	VSKCS403/100	UNITS
Maximum DC reverse voltage	V_R	100	V
Maximum working peak reverse voltage	V_{RWM}		

ABSOLUTE MAXIMUM RATINGS					
PARAMETER	SYMBOL	TEST CONDITIONS		VALUES	UNITS
Maximum average forward current	$I_{F(AV)}$	50 % duty cycle at $T_C = 111\text{ }^\circ\text{C}$, rectangular waveform		400	A
				200	
Maximum peak one cycle non-repetitive surge current	I_{FSM}	5 μs sine or 3 μs rect. pulse	Following any rated load condition and with rated V_{RRM} applied	25 500	
		10 ms sine or 6 ms rect. pulse		3300	
Non-repetitive avalanche energy	E_{AS}	$T_J = 25\text{ }^\circ\text{C}$, $I_{AS} = 5.5\text{ A}$, $L = 1\text{ mH}$		15	mJ
Repetitive avalanche current	I_{AR}	Current decaying linearly to zero in 1 μs Frequency limited by T_J maximum $V_A = 1.5 \times V_R$ typical		1	A

ELECTRICAL SPECIFICATIONS					
PARAMETER	SYMBOL	TEST CONDITIONS		VALUES	UNITS
Maximum forward voltage drop	V_{FM}	200 A	$T_J = 25\text{ }^\circ\text{C}$	0.99	V
		400 A		1.3	
		200 A	$T_J = 125\text{ }^\circ\text{C}$	0.83	
		400 A		1.09	
Maximum reverse leakage current	I_{RM}	$T_J = 25\text{ }^\circ\text{C}$	$V_R = \text{Rated } V_R$	6	mA
		$T_J = 125\text{ }^\circ\text{C}$		80	
Maximum junction capacitance	C_T	$V_R = 5 V_{DC}$ (test signal range 100 kHz to 1 MHz), $25\text{ }^\circ\text{C}$		5500	pF
Typical series inductance	L_S	Measured lead to lead 5 mm from package body		5.0	nH
Maximum voltage rate of change	dV/dt	Rated V_R		10 000	V/ μs
Maximum RMS insulation voltage	V_{INS}	50 Hz		3000 (1 min)	V
				3600 (1 s)	

THERMAL - MECHANICAL SPECIFICATIONS					
PARAMETER	SYMBOL	TEST CONDITIONS		VALUES	UNITS
Maximum junction and storage temperature range	T_J, T_{Stg}			- 55 to 175	$^\circ\text{C}$
Maximum thermal resistance, junction to case per leg	R_{thJC}	DC operation		0.26	$^\circ\text{C/W}$
Typical thermal resistance, case to heatsink per module	R_{thCS}			0.1	
Approximate weight				75	g
				2.7	oz.
Mounting torque $\pm 10\%$	to heatsink	A mounting compound is recommended and the torque should be rechecked after a period of 3 h to allow for the spread of the compound.		4	Nm
	busbar			3	
Case style		JEDEC		TO-240AA compatible	

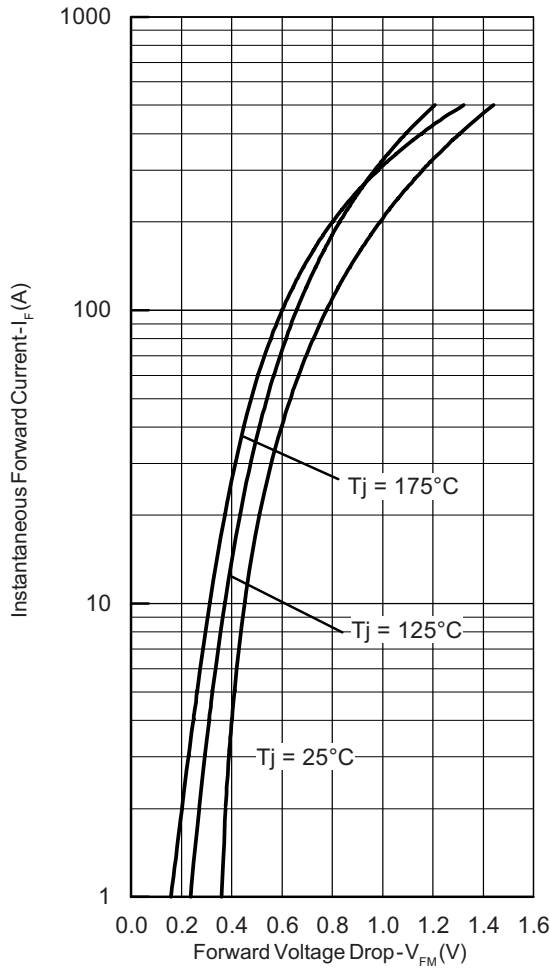

Fig. 1 - Maximum Forward Voltage Drop Characteristics

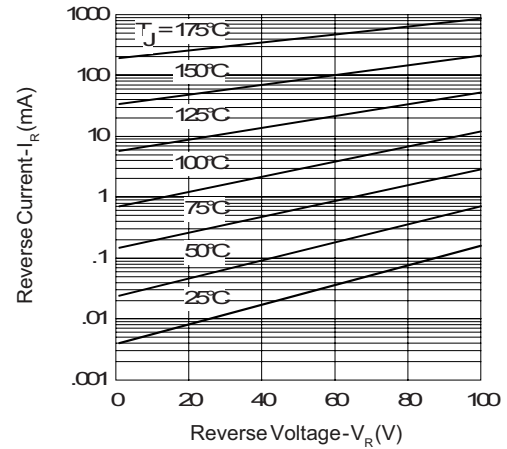

Fig. 2 - Typical Values of Reverse Current vs. Reverse Voltage

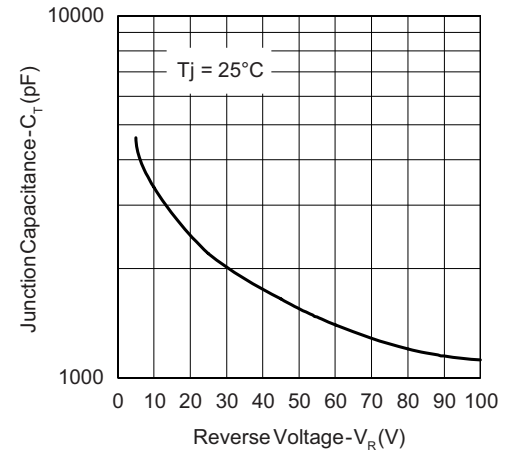

Fig. 3 - Typical Junction Capacitance vs. Reverse Voltage

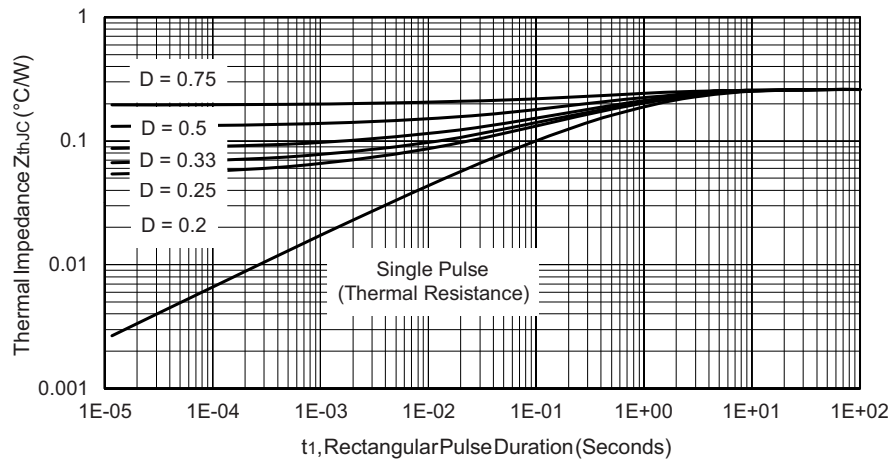

Fig. 4 - Maximum Thermal Impedance Z_{thJC} Characteristics

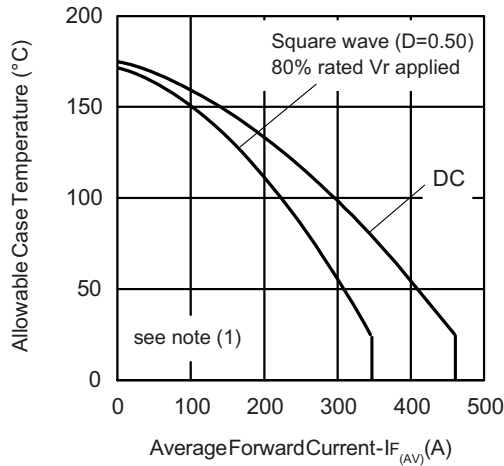

Fig. 5 - Maximum Allowable Case Temperature vs. Average Forward Current

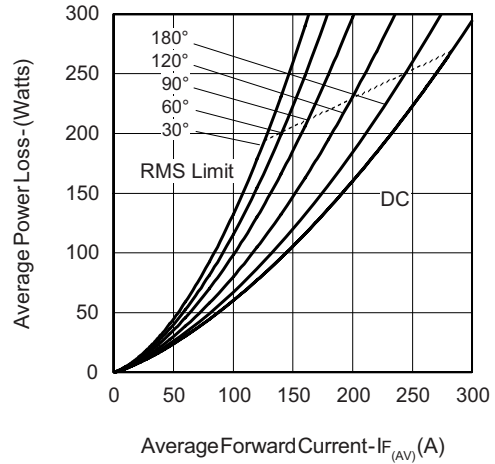

Fig. 6 - Forward Power Loss Characteristics

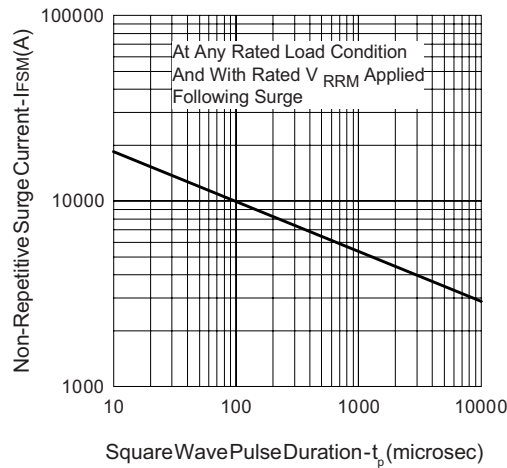

Fig. 7 - Maximum Non-Repetitive Surge Current

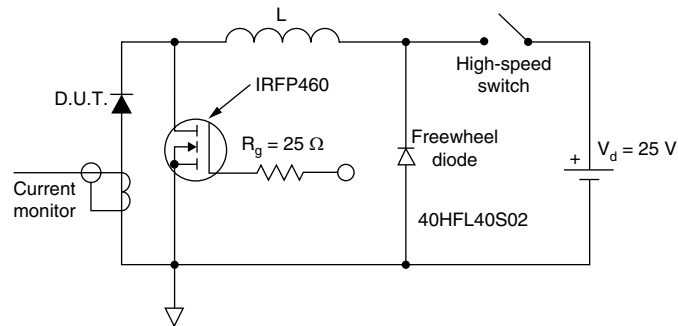

Fig. 8 - Unclamped Inductive Test Circuit

Note

- (1) Formula used: $T_C = T_J - (P_d + P_{d_{REV}}) \times R_{thJC}$;
- P_d = Forward power loss = $I_{F(AV)} \times V_{FM}$ at $(I_{F(AV)}/D)$ (see fig. 6);
- $P_{d_{REV}}$ = Inverse power loss = $V_{R1} \times I_R (1 - D)$; I_R at $V_{R1} = 80\%$ rated V_R

ORDERING INFORMATION TABLE

Device code	VS	KC	S	40	3	/	100
	①	②	③	④	⑤		⑥

- 1** - Vishay HPP
- 2** - Circuit configuration:
KC = ADD-A-PAK - 2 diodes/common cathode
- 3** - S = Schottky diode
- 4** - Average rating (x 10)
- 5** - Product silicon identification
- 6** - Voltage rating (100 = 100 V)

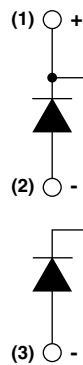
CIRCUIT CONFIGURATION

LINKS TO RELATED DOCUMENTS

Dimensions	www.vishay.com/doc?95369
------------	--

ADD-A-PAK Generation VII - Diode

DIMENSIONS in millimeters (inches)





Disclaimer

ALL PRODUCT, PRODUCT SPECIFICATIONS AND DATA ARE SUBJECT TO CHANGE WITHOUT NOTICE TO IMPROVE RELIABILITY, FUNCTION OR DESIGN OR OTHERWISE.

Vishay Intertechnology, Inc., its affiliates, agents, and employees, and all persons acting on its or their behalf (collectively, "Vishay"), disclaim any and all liability for any errors, inaccuracies or incompleteness contained in any datasheet or in any other disclosure relating to any product.

Vishay makes no warranty, representation or guarantee regarding the suitability of the products for any particular purpose or the continuing production of any product. To the maximum extent permitted by applicable law, Vishay disclaims (i) any and all liability arising out of the application or use of any product, (ii) any and all liability, including without limitation special, consequential or incidental damages, and (iii) any and all implied warranties, including warranties of fitness for particular purpose, non-infringement and merchantability.

Statements regarding the suitability of products for certain types of applications are based on Vishay's knowledge of typical requirements that are often placed on Vishay products in generic applications. Such statements are not binding statements about the suitability of products for a particular application. It is the customer's responsibility to validate that a particular product with the properties described in the product specification is suitable for use in a particular application. Parameters provided in datasheets and/or specifications may vary in different applications and performance may vary over time. All operating parameters, including typical parameters, must be validated for each customer application by the customer's technical experts. Product specifications do not expand or otherwise modify Vishay's terms and conditions of purchase, including but not limited to the warranty expressed therein.

Except as expressly indicated in writing, Vishay products are not designed for use in medical, life-saving, or life-sustaining applications or for any other application in which the failure of the Vishay product could result in personal injury or death. Customers using or selling Vishay products not expressly indicated for use in such applications do so at their own risk and agree to fully indemnify and hold Vishay and its distributors harmless from and against any and all claims, liabilities, expenses and damages arising or resulting in connection with such use or sale, including attorneys fees, even if such claim alleges that Vishay or its distributor was negligent regarding the design or manufacture of the part. Please contact authorized Vishay personnel to obtain written terms and conditions regarding products designed for such applications.

No license, express or implied, by estoppel or otherwise, to any intellectual property rights is granted by this document or by any conduct of Vishay. Product names and markings noted herein may be trademarks of their respective owners.