

PLEASE CHECK WWW.MOLEX.COM FOR LATEST PART INFORMATION

Part Number: [0462071010](#)
Status: **Active**
Description: 4.20mm (.165") Pitch Mini-Fit RTC™ Reflow High Temperature Compatible Header, Dual Row, Vertical, 10 Circuits, 1.57mm (.062") PCB Thickness, No PCB Pegs, LCP Housing, with Tin (Sn) Over Nickel (Ni) Plating

Documents:

[3D Model](#) [RoHS Certificate of Compliance \(PDF\)](#)
[Drawing \(PDF\)](#)

Agency Certification

CSA LR19980
 UL E29179

General

Product Family PCB Headers
 Series [46207](#)
 Application Board-to-Board, Wire-to-Board
 Comments Current = 13A max. per circuit when header is mated to a receptacle loaded with [45750](#) Mini-Fit Plus HCS™ Crimp Terminal Crimped to to 16 AWG wire. . See Molex product specification PS-45750-001 for additional current de-rating information.
 Product Name Mini-Fit RTC™

Physical

Breakaway No
 Circuits (Loaded) 10
 Circuits (maximum) 10
 Color - Resin Black
 Durability (mating cycles max) 75
 First Mate / Last Break No
 Flammability 94V-0
 Glow-Wire Compliant No
 Guide to Mating Part No
 Keying to Mating Part None
 Lock to Mating Part Yes
 Material - Metal Brass
 Material - Plating Mating Tin
 Material - Plating Termination Nickel
 Material - Resin High Temperature Thermoplastic
 Number of Rows 2
 Orientation Vertical
 PC Tail Length (in) 0.144 In
 PC Tail Length (mm) 3.66 mm
 PCB Locator Yes
 PCB Retention Yes
 PCB Thickness Recommended (in) 0.062 In
 PCB Thickness Recommended (mm) 1.57 mm
 Packaging Type Tray
 Pitch - Mating Interface (in) 0.165 In
 Pitch - Mating Interface (mm) 4.20 mm
 Pitch - Term. Interface (in) 0.165 In
 Pitch - Term. Interface (mm) 4.20 mm
 Polarized to Mating Part Yes
 Polarized to PCB Yes

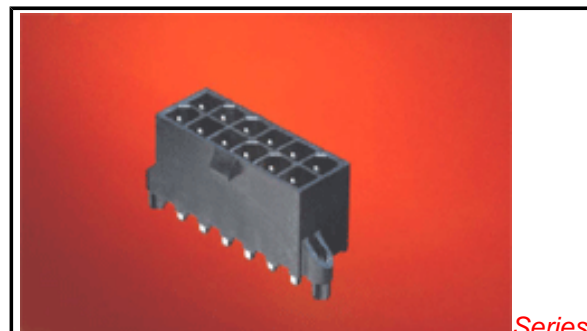

image - Reference only

Series

EU RoHS

ELV and RoHS Compliant

REACH SVHC

Contains SVHC: No

Halogen-Free

Status

Halogen-Free

Need more information on product environmental compliance?

China RoHS



Email productcompliance@molex.com
 For a multiple part number RoHS Certificate of Compliance, [click here](#)

Please visit the [Contact Us](#) section for any non-product compliance questions.

Search Parts in this Series

[46207Series](#)

Mates With

[5557 Mini Fit Jr.™ Receptacle](#)

Shrouded	Fully
Stackable	No
Surface Mount Compatible (SMC)	Yes
Temperature Range - Operating	-40°C to +105°C
Termination Interface: Style	Through Hole

Electrical

Current - Maximum per Contact	13A
Voltage - Maximum	600V AC (RMS)/DC

Solder Process Data

Duration at Max. Process Temperature (seconds)	30
Lead-free Process Capability	SMC & Wave Capable (TH only)
Max. Cycles at Max. Process Temperature	3
Process Temperature max. C	260

Material Info

Reference - Drawing Numbers

Packaging Specification	PK-46207-001
Sales Drawing	SD-46207-002

This document was generated on 05/17/2010

PLEASE CHECK WWW.MOLEX.COM FOR LATEST PART INFORMATION

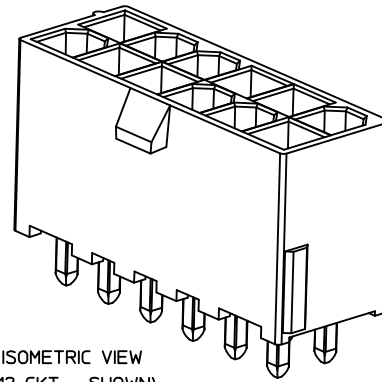
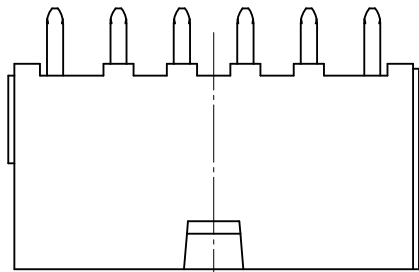

ISOMETRIC VIEW
(12 CKT - SHOWN)

CKT SIZE	DIM. A	DIM. B
02	0.21/5.4	NA
04	0.38/9.6	0.165/4.20
06	0.54/13.8	0.331/8.40
08	0.71/18.0	0.496/12.60
10	0.87/22.2	0.661/16.80
12	1.04/26.4	0.827/21.00
14	1.21/30.6	0.992/25.20
16	1.37/34.8	1.160/29.40
18	1.54/39.0	1.323/33.60
20	1.70/43.2	1.488/37.80
22	1.87/47.4	1.654/42.00
24	2.03/51.6	1.819/46.20

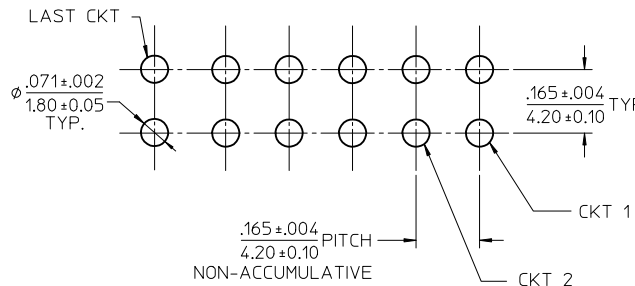
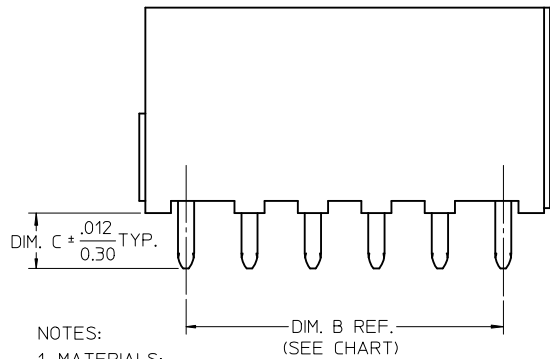
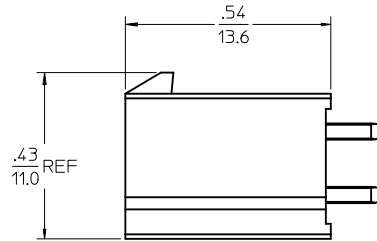
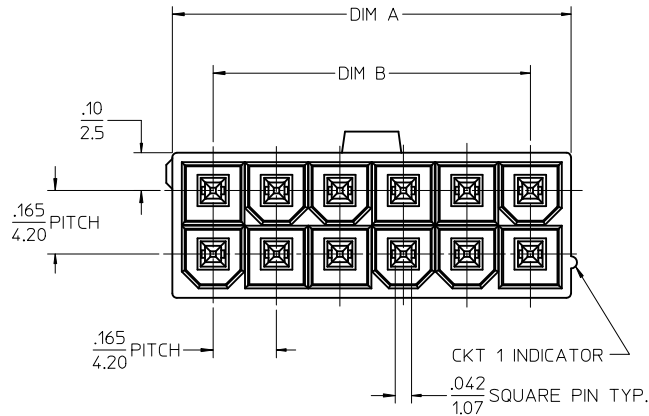

LAYOUT FOR
4-24 CIRCUITS

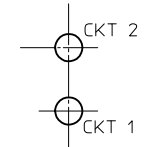

LAYOUT FOR
2 CIRCUIT

RECOMMENDED PCB HOLE LAYOUT COMPONENT SIDE

NOTES:

- MATERIALS:
HOUSING - LIQUID CRYSTAL POLYMER (LCP), COLOR: BLACK
TERMINAL - BRASS
- TERMINAL PLATING:
TIN= .000100/0.00254 MIN. MATTE TIN OVER
.000050/0.00127 MIN. NICKEL
GOLD=.000030/0.00076 MIN. SELECT GOLD OVER
.000100/0.00254 MIN. SELECT MATTE TIN
OVER .000050/0.00127 MIN. NICKEL OVERALL.
- PRODUCT SPECIFICATION: PS-46207-001
- PACKAGING SPECIFICATION: TRAY PACK PER: PK-46207-001
TAPE AND REEL PACK PER: PK-46207-002
- PART CONFORMS TO CLASS "B" REQUIREMENTS OF COSMETIC ' SPECIFICATION PS-45499-002.

ADD GOLD PN EC NO: UCP2010-1779 DRWN: JAGUILAR 2010/01/26 CHKD: JBELL 2010/02/22 APPR: FSMITH 2010/02/22	QUALITY SYMBOLS ▽=0 ▽=0	GENERAL TOLERANCES (UNLESS SPECIFIED)		DIMENSION STYLE IN/MM	SCALE 4:1	DESIGN UNITS METRIC	THIRD ANGLE PROJECTION	
				DRAWN BY LSCHMIDT	DATE 2007/12/14	MINI-FIT RTC HI-TEMP VERTICAL HEADER IN LCP, W/O PCB PEGS MOLEX INCORPORATED		
				CHECKED BY JBELL	DATE 2007/12/17			
				APPROVED BY FSMI THROEMER 2007/12/18		DATE	DOCUMENT NO. SD-46207-002	SHEET NO. 1 OF 2

DRAFT WHERE APPLICABLE MUST REMAIN WITHIN DIMENSIONS

SEE CHART

THIS DRAWING CONTAINS INFORMATION THAT IS PROPRIETARY TO MOLEX INCORPORATED AND SHOULD NOT BE USED WITHOUT WRITTEN PERMISSION

GOLD PLATING					
CKT SIZE	TAPE & REEL MATERIAL NUMBER	TRAY PACK MATERIAL NUMBER	DIM. C	PCB THK.	
02	462078002	* 462076002	* 0.144/3.66	0.062	
04	462078004	* 462076004	* 0.144/3.66	0.062	
06	462078006	* 462076006	* 0.144/3.66	0.062	
08	462078008	* 462076008	* 0.144/3.66	0.062	
10	462078010	* 462076010	* 0.144/3.66	0.062	
12	462078012	* 462076012	* 0.144/3.66	0.062	
14	462078014	* 462076014	* 0.144/3.66	0.062	
16	462078016	* 462076016	* 0.144/3.66	0.062	
18	462078018	* 462076018	* 0.144/3.66	0.062	
20	462078020	* 462076020	* 0.144/3.66	0.062	
22	462078022	* 462076022	* 0.144/3.66	0.062	
24	462078024	* 462076024	* 0.144/3.66	0.062	
02					
04					
06					
08					
10					
12					
14					
16					
18					
20					
22					
24					

TIN PLATING					
CKT SIZE	TAPE & REEL MATERIAL NUMBER	TRAY PACK MATERIAL NUMBER	DIM. C	PCB THK.	
02	462074002	* 462071002	* 0.144/3.66	0.062	
04	462074004	* 462071004	* 0.144/3.66	0.062	
06	462074006	* 462071006	* 0.144/3.66	0.062	
08	462074008	* 462071008	* 0.144/3.66	0.062	
10	462074010	* 462071010	* 0.144/3.66	0.062	
12	462074012	* 462071012	* 0.144/3.66	0.062	
14	462074014	* 462071014	* 0.144/3.66	0.062	
16	462074016	* 462071016	* 0.144/3.66	0.062	
18	462074018	* 462071018	* 0.144/3.66	0.062	
20	462074020	* 462071020	* 0.144/3.66	0.062	
22	462074022	* 462071022	* 0.144/3.66	0.062	
24	462074024	* 462071024	* 0.144/3.66	0.062	
02		462071102	* 0.176/4.46	0.093	
04		462071104	0.176/4.46	0.093	
06		462071106	0.176/4.46	0.093	
08		462071108	0.176/4.46	0.093	
10		462071110	0.176/4.46	0.093	
12		462071112	0.176/4.46	0.093	
14		462071114	* 0.176/4.46	0.093	
16		462071116	* 0.176/4.46	0.093	
18		462071118	* 0.176/4.46	0.093	
20		462071120	* 0.176/4.46	0.093	
22		462071122	* 0.176/4.46	0.093	
24		462071124	0.176/4.46	0.093	
02		462071202	* 0.207/5.26	0.125	
04		462071204	0.207/5.26	0.125	
06		462071206	0.207/5.26	0.125	
08		462071208	0.207/5.26	0.125	
10		462071210	0.207/5.26	0.125	
12		462071212	0.207/5.26	0.125	
14		462071214	* 0.207/5.26	0.125	
16		462071216	* 0.207/5.26	0.125	
18		462071218	* 0.207/5.26	0.125	
20		462071220	* 0.207/5.26	0.125	
22		462071222	* 0.207/5.26	0.125	
24		462071224	0.207/5.26	0.125	

* DESIGNATES PART NOT RELEASED.
CONTACT FACTORY FOR AVAILABILITY.

* DESIGNATES PART NOT RELEASED.
CONTACT FACTORY FOR AVAILABILITY.

SEE SHEET 1 EC NO: UCP2010-1779 DRWN: JAGUILAR 2010/01/26 CHKD: J BELL 2010/02/22 APPR: FSMITH 2010/02/22	QUALITY SYMBOLS	GENERAL TOLERANCES (UNLESS SPECIFIED)	DIMENSION STYLE	SCALE	DESIGN UNITS	THIRD ANGLE PROJECTION
	▽=0	mm INCH	IN/MM	1:1	METRIC	
	▽=0	4 PLACES ± --- ± ---	DRAWN BY DATE	TITLE		
	▽=0	3 PLACES ± --- ±.005	LSCHMIDT 2007/12/14	MINI-FIT RTC HI-TEMP VERTICAL HEADER IN LCP, W/O PCB PEGS		
	2 PLACES ±0.13 ±.010	CHECKED BY DATE	MOLEX INCORPORATED			
	1 PLACE ±0.25 ± ---	JBELL 2007/12/17	SD-46207-002			
	ANGULAR ±1/2°	APPROVED BY DATE	SHEET NO.			
		FSMI THROEMER 2007/12/18	2 OF 2			
		MATERIAL NO.	DOCUMENT NO.			
		SEE CHART	THIS DRAWING CONTAINS INFORMATION THAT IS PROPRIETARY TO MOLEX INCORPORATED AND SHOULD NOT BE USED WITHOUT WRITTEN PERMISSION			