

# APPROVAL

PART NO.	DESCRIPTION	REMARKS
<b>HT2204L</b>	<b>LCD MODULE</b> (240 x RGB x 320 Dots)	<b>This is ROHS compliant</b>

CUSTOMER APPLICATION P/N	
APPROVED BY	
DATE	

PLEASE KINDLY FIND AND APPROVE THE SPECIFICATIONS INSERTED  
HEREIN AND RETURN ONE COPY HERE OF WITH YOUR SIGNATURE OF APPROVAL.

PERPARED BY	CHECKED BY	CONFIRMED BY



**HYES Optoelectronics, Inc.**

2000 Wyatt Drive Suite 6  
Santa Clara, CA 95054 USA



# CONTENTS

- 1. Basic Specifications**
  - 1.1 Display Specifications**
  - 1.2 Mechanical Specifications**
  - 1.3 Outline Dimension**
  - 1.4 Voltage Generation Circuit**
  - 1.5 Schematic**
- 2. Electrical Characteristics**
  - 2.1 Absolute Maximum Ratings**
  - 2.2 Environmental Conditions**
  - 2.3 DC Characteristics**
- 3. Optical Characteristics**
- 4. Interface Pins**
- 5. Backlight Specifications (LED Unit)**
- 6. Recommended Software Setting Values (Initial code)**
- 7. Power Supply Sequence**
- 8. Read/Write Timing characteristics (80 series MPU)**
- 9. LCD Module Out-Going Quality Level**
- 10. The Caution and Handling**

Date : Apr. 18, 2008

TECHNICAL SPECIFICATION

**HYES**

LCM

HT2204L

Page 3 of 24

## 1. Basic Specifications

### 1.1 Display Specifications

Item	Description	Note
Resolution	240 × RGB × 320	
Display mode	TFT, Normally White, Transmissive	262K Color
Viewing direction	6 O'clock	
Driving method	720Ch-Source, 320Ch-Gate	
Backlighting	LED, White (4 chips in Serial)	
Diver IC	R61505U, COG	
Others	8/9/16/18-Bit, 80-Series	

### 1.2 Mechanical Specifications

Item	Specification	Unit
Module Size (W × H × T)	39.6 × 56.0 × 2.30	mm
Viewing Area (W × H)	-	mm
Active Area (W × H)	33.48 × 44.64	mm
Dot Size (W × H)	0.037 × 0.131	mm
Dot Pitch (W × H)	0.047 × 0.141	mm
Weight	About 9	g

Date : Apr. 18, 2008

TECHNICAL SPECIFICATION

**HYES**

LCM

HT2204L

Page 4 of 24

# 1.3 Outline Dimension

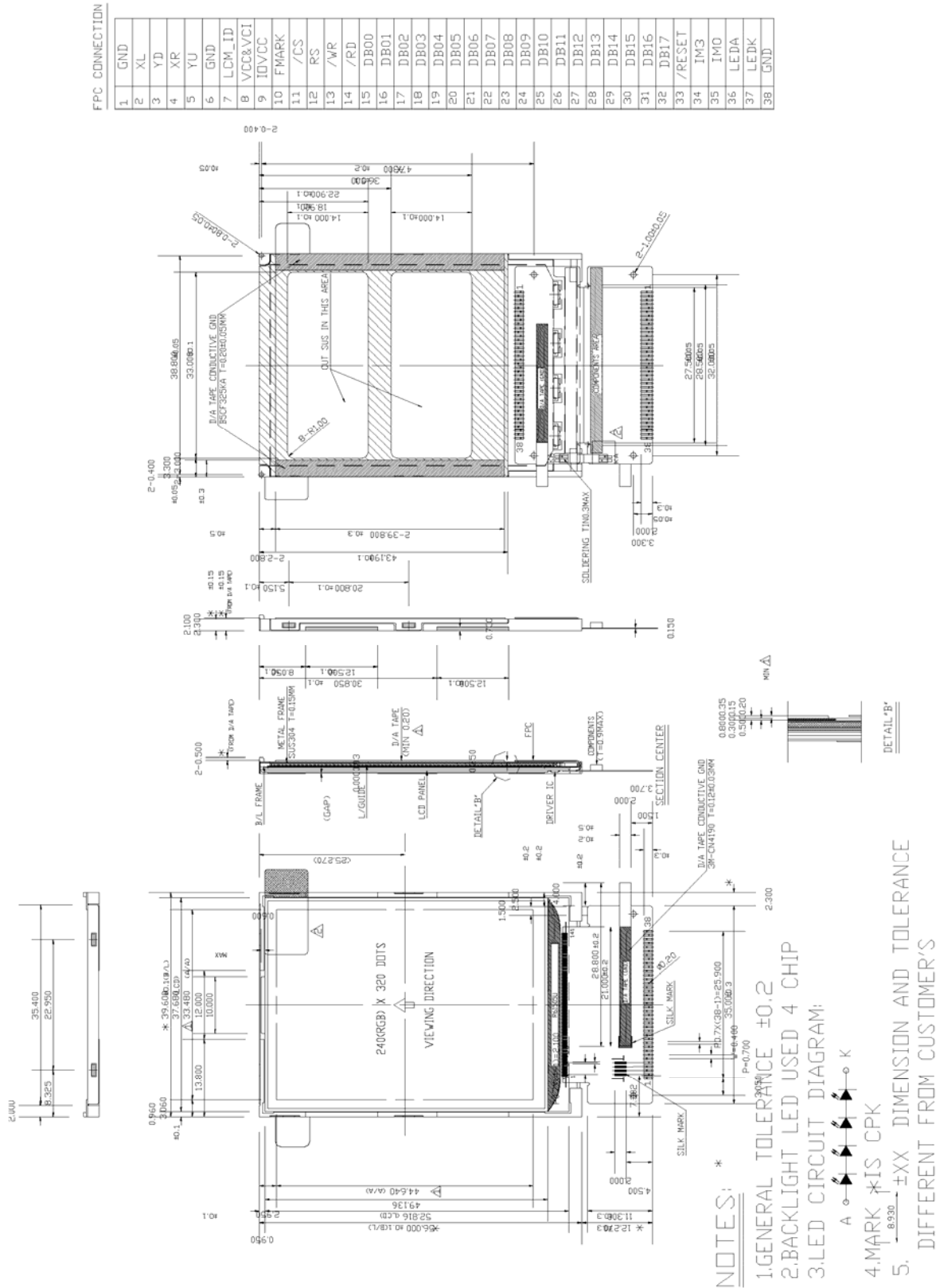

Date : Apr. 18, 2008

TECHNICAL SPECIFICATION



LCM

HT2204L

Page 5 of 24

## 1.4 Block Diagram

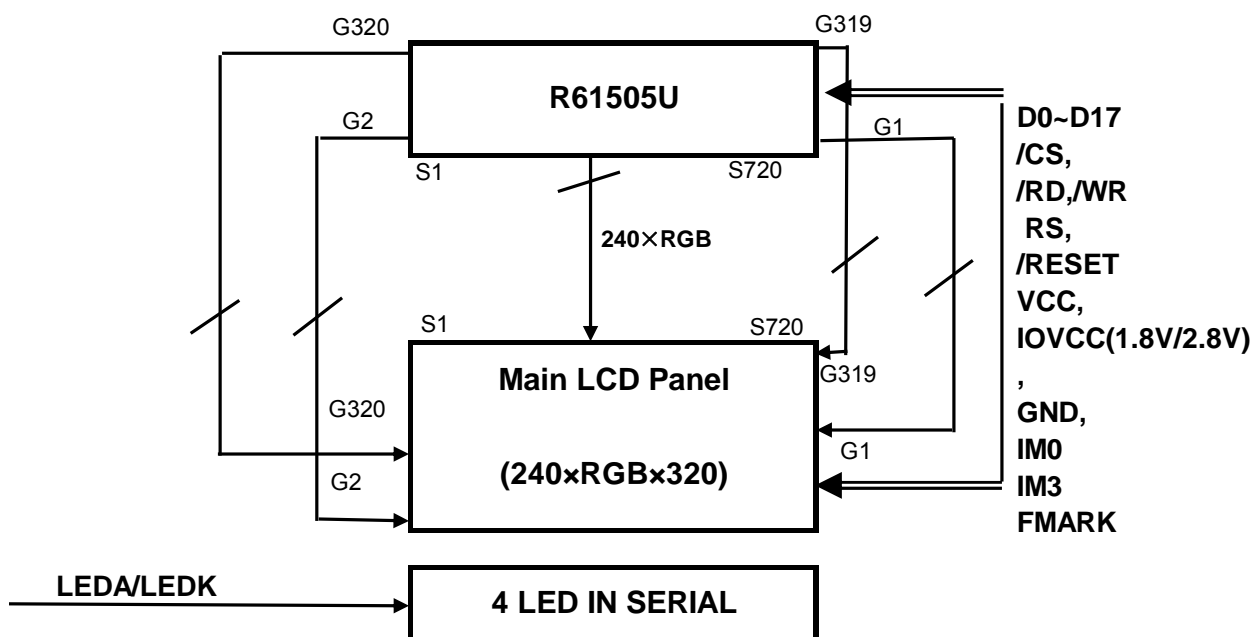

IM3	IM0	Interface	Databus
0	0	16-bit interface	DB17-10 , DB8-1
0	1	8-bit interface	DB17-10
1	0	18-bit interface	DB17-0
1	1	9-bit interface	DB17-9

# 1.5 Schematic

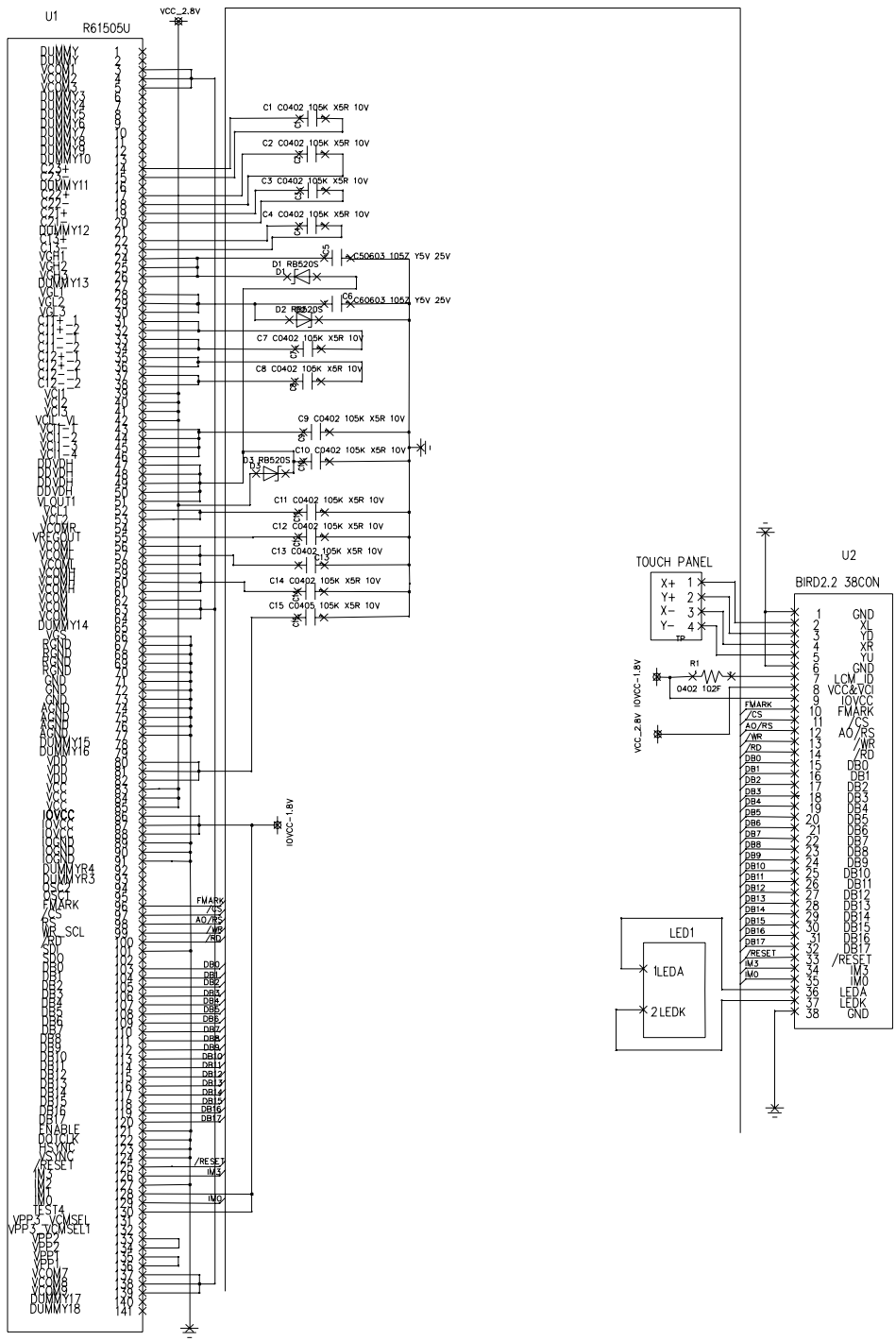

Date : Apr. 18, 2008

TECHNICAL SPECIFICATION



LCM

HT2204L

Page 7 of 24

## 2. Electrical Characteristics

### 2.1 Absolute Maximum Ratings

Item	Symbol	Value			Unit	Condition	Remark
		Min.	Typ.	Max			
Supply Voltage Range	Logic	V <sub>CC</sub>	-0.3	-	5.0	V	T <sub>a</sub> =25℃
	LCD	V <sub>GH-VGL</sub>	-0.3	-	35	V	T <sub>a</sub> =25℃
			-	-	-	V	T <sub>a</sub> =26℃
Input Voltage	V <sub>IN</sub>	-0.3	-	V <sub>CC</sub>	V	T <sub>a</sub> =25℃	

### 2-2 Environmental Conditions

Item	Symbol	Min.	Max.	Unit
Operating temperature	T <sub>opr</sub>	-20	70	℃
Storage temperature	T <sub>stg</sub>	-30	80	℃
Humidity (Ambient temperature=T <sub>a</sub> )	T <sub>a</sub> ≤ 60℃		90% RH max.	

### 2-3 DC Characteristics

Items	Symbol	Spec. Value			Unit	Condition	
		Min.	Typ.	Max.			
Operating voltage	Logic	V <sub>CC</sub>	2.72	2.8	2.88	V	
		IOV <sub>CC</sub>	1.78	1.8	1.83	V	
	GATE	V <sub>GH-VGL</sub>	18	-	26	V	Note 1)
Supply current	ICC	-	6.0	9.0	mA	Note 2)	
Input voltage	High level	V <sub>IH</sub>	0.8 × IOV <sub>CC</sub>	-	IOV <sub>CC</sub>	V	-
	Low level	V <sub>IL</sub>	-0.3	-	0.2 × IOV <sub>CC</sub>	V	-

Note 1) The value can be adjusted by software to optimize display quality

Note 2) Display White

Date : Apr. 18, 2008

TECHNICAL SPECIFICATION

**HYES**

LCM

HT2204L

Page 8 of 24



### 3. Optical Characteristics

Transmissive mode

(Ta = 25°C)

Item	Symbol		Min.	Typ.	Max.	Unit	Condition	Note
Viewing	θ2-θ1	∅=0 (Y1-Y2)	60	70	-	Deg	Cr > 10	
		∅=90 (X1-X2)	80	90	-			
Contrast ratio	Cr		200	300	-	-	θ = 0 ∅ = 0	
Response Time	Tr + Tf		-	25	40	ms	θ = 0 ∅ = 0	
CIE Coordi - nate	R	(x,y)	0.58, 0.30	0.63, 0.35	0.68, 0.40		θ = 0 ∅ = 0	
	G	(x,y)	0.28, 0.55	0.33, 0.60	0.38, 0.65			
	B	(x,y)	0.09, 0.03	0.14, 0.08	0.19, 0.13			
	W	(x,y)	0.24, 0.25	0.29, 0.30	0.34, 0.35			
Brightness	L		200	240	-	cd/m <sup>2</sup>	18mA/LED	
Uniformity			70	-	-			

\* ∅ = 0°, ∅ = 90° means viewing direction.

\* B/L is turned on.

\* Remark : as for contrast ratio, it is measured in panel only.

Date : Apr. 18, 2008

TECHNICAL SPECIFICATION

**HYES**

LCM

HT2204L

Page 9 of 24

Note 1 . Definition of angle  $\Theta$  and  $\Phi$

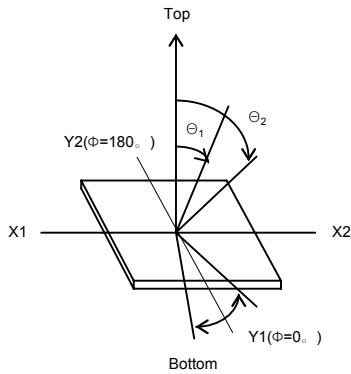

Note 2. Definition of viewing angle  $\Theta_1$  and  $\Theta_2$

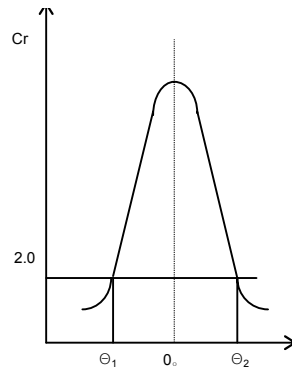

Note 3. Definition of contrast Cr

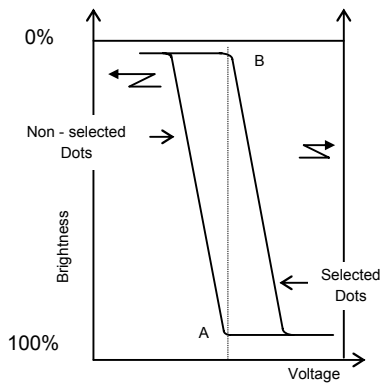

$Cr = (A/B)^P$  Negative : P = -1 Set Point  
Positive : P = +1

Lens  $\varnothing = 3\text{mm}$

Note 4. Definition of Optical response

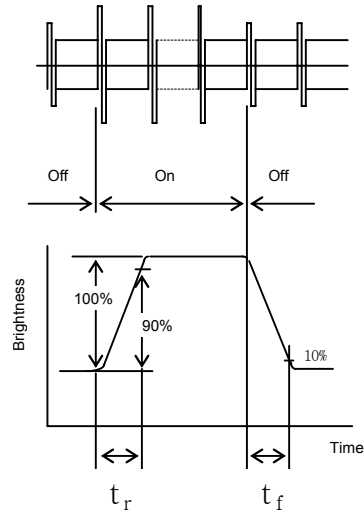

Note 5. Measuring Point(9 POINTS) (WxH)

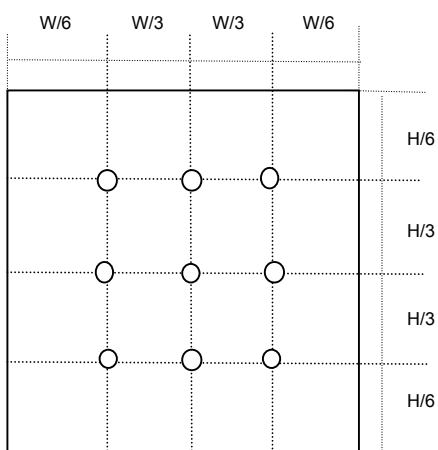

Rating is defined as the average brightness inside the viewing area

Date : Apr. 18, 2008

TECHNICAL SPECIFICATION

**HYES**

LCM

HT2204L

Page 10 of 24

#### 4. Interface Pins

no	symbol	Description
1	GND	GND
2	XL	Touch panel X-
3	YD	Touch panel Y-
4	XR	Touch panel X+
5	YU	Touch panel Y+
6	GND	GND
7	LCM_ID	Connect a 1K Resistor to IOVCC(1.8V/2.8V)
8	VCC&VCI	VCC(2.8V)
9	IOVCC	IOVCC(1.8V/2.8V)
10	FMARK	Frame head pulse signal
11	/CS	Chip select signal(low active)
12	RS	RS Signal (RS=0 : Contro,RS=1 : data)
13	/WR	Write Signal (low active)
14	/RD	Read Signal(low active)
15	DB0	Data Bit0
16	DB1	Data Bit1
17	DB2	Data Bit2
18	DB3	Data Bit3
19	DB4	Data Bit4
20	DB5	Data Bit5
21	DB6	Data Bit6
22	DB7	Data Bit7
23	DB8	Data Bit8
24	DB9	Data Bit9
25	DB10	Data Bit10
26	DB11	Data Bit11
27	DB12	Data Bit12
28	DB13	Data Bit13
29	DB14	Data Bit14
30	DB15	Data Bit15
31	DB16	Data Bit16
32	DB17	Data Bit17
33	/RESET	RESET signal(low active)
34	IM3	system interface control
35	IM0	system interface control
36	LEDA	LED Anode
37	LEDK	LED Cathode
38	GND	GND

Date : Apr. 18, 2008

TECHNICAL SPECIFICATION

**HYES**

LCM

HT2204L

Page 11 of 24

## 5. Backlight Specification (LED Unit)

Item	Symbol	Spec. Value			Unit	Condition
		Min.	Typ.	Max.		
Real Current	$I_{LED}$	-	18	20	mA	note 1.
Power dissipation	$P_D$	-	-	300	mW	note 2.
Operation temp.	$T_{opr}$	- 20 ~ 70			°C	-
Storage temp.	$T_{str}$	- 30 ~ 80			°C	-

Note 1. B/L: 4EA LED in Serial, the typical current is 20mA (full brightness).

Note2. Total power consumption(max) depends on LED current/ LED driver efficiency, etc.

## 6. Recommended Software Setting Values (Initial code)

LDI :R61505U

REG NO	VALUE
0007	0000
0012	0000 (DALAY 20)ms
00A4	0001 (DALAY 20)ms
0060	2700
0008	0404
0030	0307
0031	0303
0032	0303
0033	0202
0034	0202
0035	0202
0036	1F1F
0037	0303
0038	0303
0039	0303
003A	0202
003B	0102
003C	0204
003D	0000
0007	0001
0017	0001
0010	17B0
0011	0007 (DALAY 50)ms
0029	0010
0012	0119
0013	1000
0012	0139 (DALAY 20)ms
0001	0100
0002	0700
0003	1030
0004	0000
0009	0000
000A	0008
000C	0000
000D	0000
0015	2203
0050	0000
0051	00EF
0052	0000
0053	013F

REG NO	VALUE
0061	0001
0090	0010
0092	0100
0093	0001(DALAY 20)ms
0007	0021
0007	0061(DALAY 20)ms
0007	0063
0007	0173
0017	0000
0022	

### Deep standby on sequence

display off sequence	
0007	0072(DALAY 20)ms
0007	0001(DALAY 20)ms
0007	0000
set deep standby mode	
0010	0004

### Deep standby off sequence

exit deep standby mode	
cs=low 6 times	
00A4	0001(DALAY 20)ms
call initial code	

### Power supply off sequence

0010	0780
0011	0067
0012	0109(DALAY 20)ms
0010	0700

### Partial display sequence

0080	0020(1st display area)
0081	0020(1st display area)
0082	0050(1st display area)
0083	0070(2st display area)
0084	0070(2st display area)
0085	00FF(2st display area)
partial display on	
0007	3073
partial display off	
0007	0173

NOTE: HYES requires the customer to follow the above instructions strictly. If customer would like to change the above instructions, the customer should inform HYES and get re-check from HYES, or the customer will be responsible for any unexpected result because of the change.

Date : Apr. 18, 2008

TECHNICAL SPECIFICATION

**HYES**

LCM

HT2204L

Page 13 of 24

# 7. Power Supply Sequence

## 7.1 Power Supply On/Off Sequence

### Power ON sequence

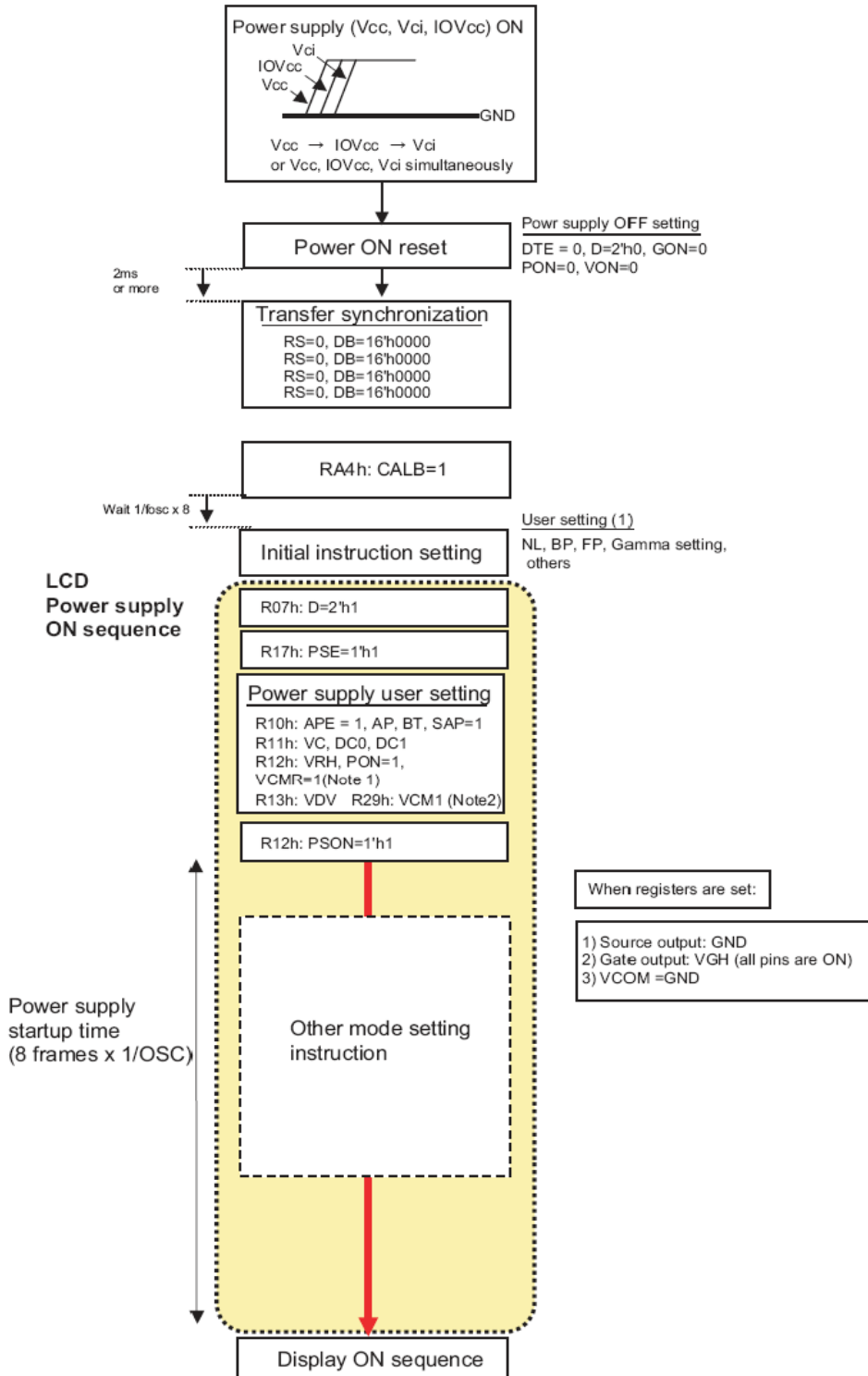

## 7.2 Off Sequence

### Power supply OFF sequence

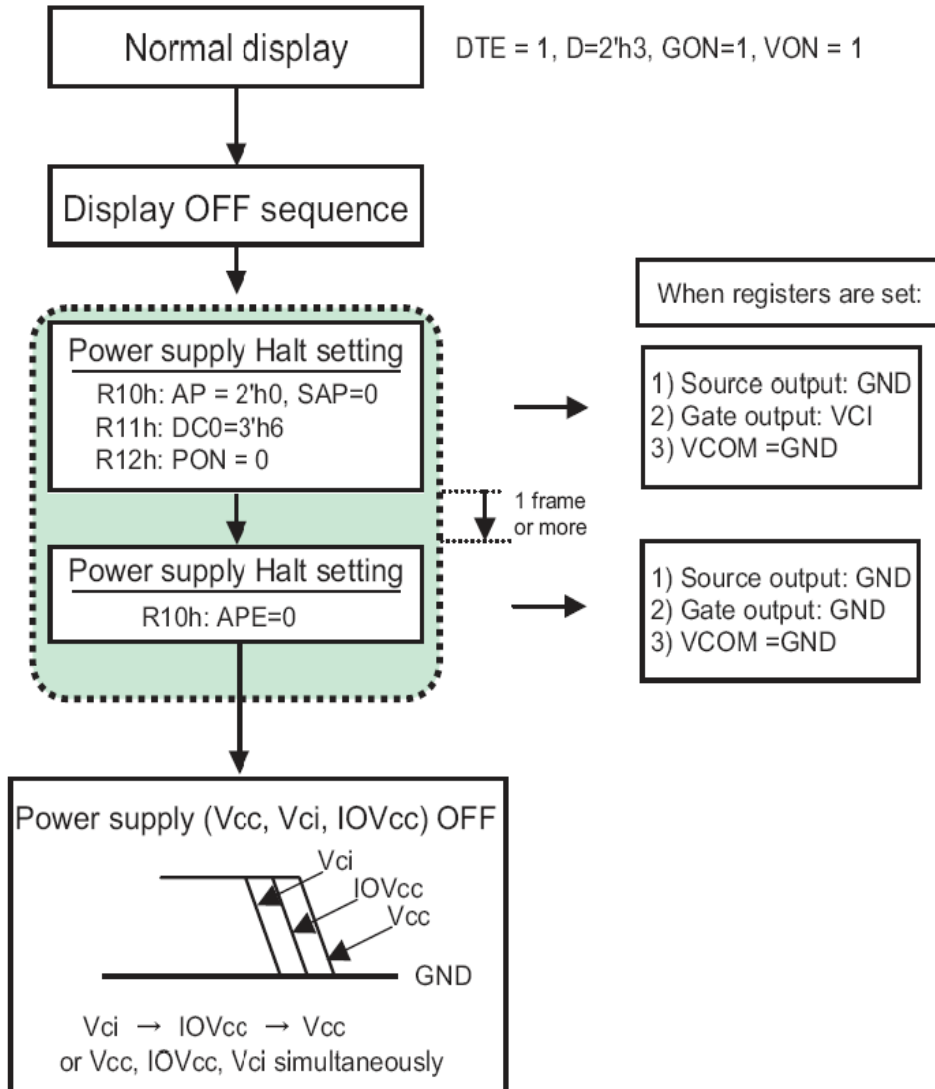

## 8. Read/Write Timing characteristics (80 series MPU)

### 1) Read/Write Timing

#### 2. 80-System Bus Interface Timing Characteristics (18-/16-bit interface)

Table 94 Normal write operation (HWM=0), IOVCC=1.65V~3.30V

Item		Symbol	Unit	Timing Diagram	Min.	Typ.	Max.
Bus cycle time	Write	tCYW	ns	Figure 98	125	—	—
	Read	tCYR	ns	Figure 98	450	—	—
Write low-level pulse width		PWLW	ns	Figure 98	45	—	—
Read low-level pulse width		PWLR	ns	Figure 98	170	—	—
Write high-level pulse width		PWHW	ns	Figure 98	70	—	—
Read high-level pulse width		PWHR	ns	Figure 98	250	—	—
Write / Read rise/ fall time		tWRr, WRf	ns	Figure 98	—	—	25
Setup time	Write (RS to CS*, WR*)	tAS	ns	Figure 98	0	—	—
	Read (RS to CS*, RD*)		ns	Figure 98	10	—	—
Address hold time		tAH	ns	Figure 98	2	—	—
Write data setup time		tDSW	ns	Figure 98	25	—	—
Write data hold time		tH	ns	Figure 98	10	—	—
Read data delay time		tDDR	ns	Figure 98	—	—	150
Read data hold time		tDHR	ns	Figure 98	5	—	—

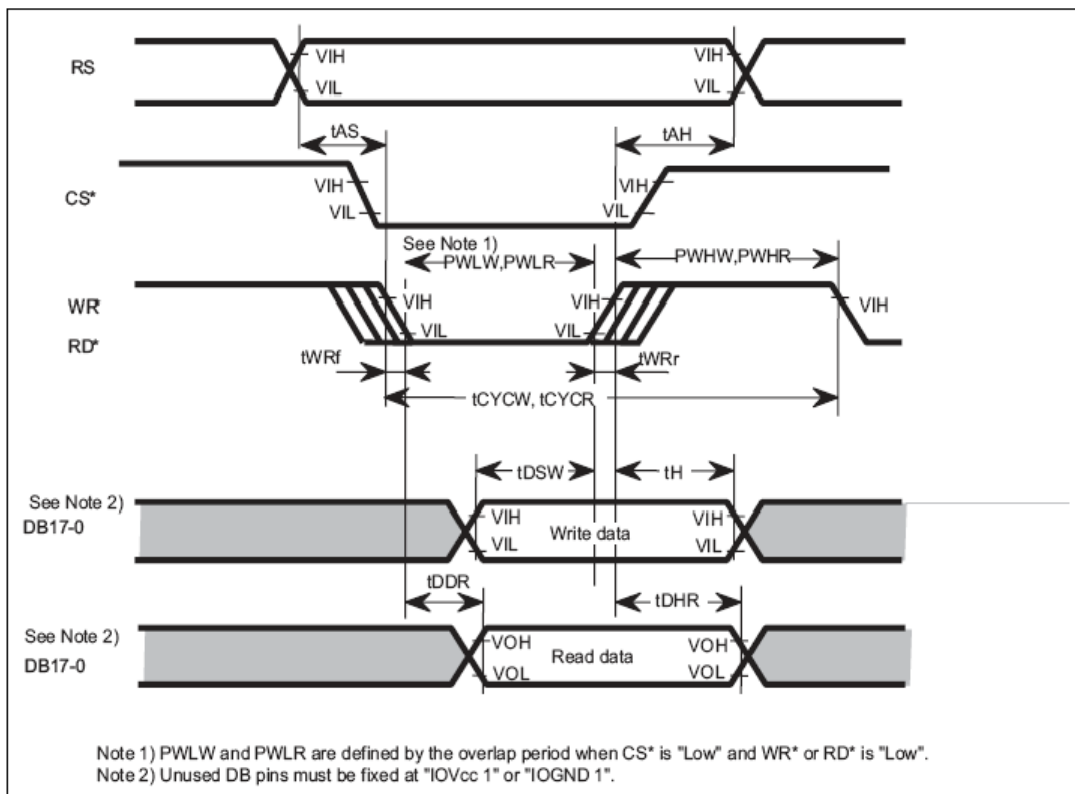

Figure 98 80-System Bus Interface

Date : Apr. 18, 2008

TECHNICAL SPECIFICATION

**HYES**

LCM

HT2204L

Page 16 of 24



## Reset Timing characteristics

### 5. Reset Timing Characteristics (IOVCC=1.65~3.30V)

Table 98

Item	Symbol	Unit	Timign Diagram	Min.	Typ.	Max.
Reset low-level width	tRES	ms	Figure 100	1	—	—
Reset rise time	trRES	μs	Figure 100	—	—	10

#### Reset Operation

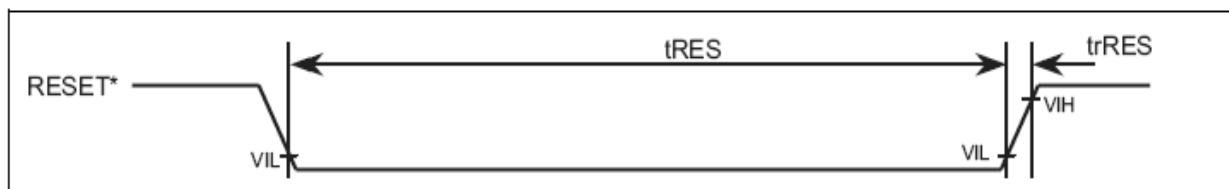

Figure 100 Reset Operation

## 9. LCD Module Out-Going Quality Level

### (1.0) Purpose

The LCD specification provides outgoing provision and its expected quality level based on our outgoing inspection of LCD.

### (2.0) Applicable Scope

The LCD specification is applicable to the arrangement in regard to outgoing inspection and quality assurance after it.

### (3.0) Quality Specification

#### (3.1) Quality Level

The quality level of HYES are based on GB/T2828.1, Apply Level II, normal inspection by single sampling.

Rank	Item	AQL	Note
Major(MA)	Segment Short, Missing	0.65	
	Solder Bridging, Cold Solder		
	Outside Dimension		
Minor (MI)	Black Spots, White Spots, Foreign Substance, Pinhole, Segment Deformation, Scratches(Glass & Pol.) Air Bubbles between Glass & Polarizer, Color Variation, Solder Ball, Misalignment	1.0	

Note) AQL- Acceptable Quality Level

#### (3.2) Appearance Standards

##### 1) Inspection Conditions

The LCD shall be inspected under 20W white fluorescent lamp light.

The distance between the eyes and the sample shall be 30cm.

All directions for inspecting the sample should be within 30° to perpendicular line.

##### 2) Definition of the Area

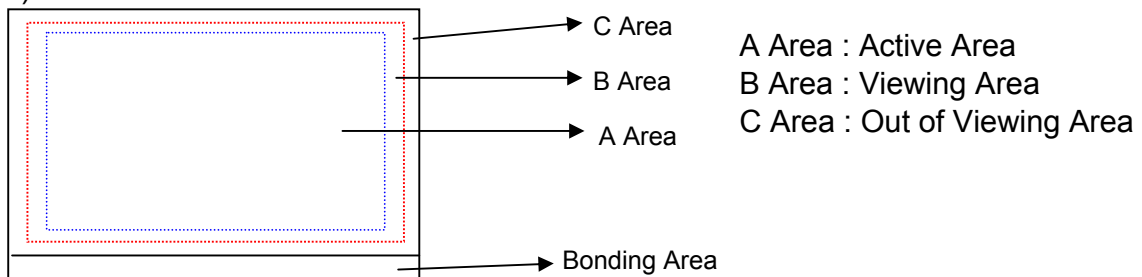

Date : Apr. 18, 2008

TECHNICAL SPECIFICATION

**HYES**

LCM

HT2204L

Page 18 of 24

(3.3) Appearance Spec

No	Item	Criteria	Rank	Remark																																													
1	Segment Short Segment Missing	Not allowed	MA																																														
2	Solder Bridging	Any bridging between components, except common circuit, is not allowed.	MA																																														
3	Outside Dimension	Drawing & specification must be within permissible tolerance.	MA																																														
4	Cold Solder	Cold solder is not allowed.	MA																																														
5	Black(White) Spots, Foreign Substances	<p>1) Round Type</p> <table border="1"> <thead> <tr> <th rowspan="2">Area Dimension***</th> <th colspan="2">Acceptable Q'ty</th> <th rowspan="2">Remark</th> </tr> <tr> <th>A Area</th> <th>B Area</th> </tr> </thead> <tbody> <tr> <td>≤ 0.1</td> <td colspan="2">Ignore</td> <td rowspan="4"></td> </tr> <tr> <td>≤ 0.2</td> <td>2</td> <td>Ignore</td> </tr> <tr> <td>≤ 0.3</td> <td>1</td> <td>Ignore</td> </tr> <tr> <td>0.3 &lt;</td> <td>0</td> <td>Ignore</td> </tr> </tbody> </table> <p>2) Liner Type</p> <table border="1"> <thead> <tr> <th colspan="2">Dimension</th> <th colspan="2">Acceptable Q'ty</th> <th rowspan="2">Remark</th> </tr> <tr> <th>Length</th> <th>Width</th> <th>A Area</th> <th>B Area</th> </tr> </thead> <tbody> <tr> <td>-</td> <td>≤ 0.025</td> <td colspan="2">Ignore</td> <td rowspan="4"></td> </tr> <tr> <td>≤ 2.5</td> <td>≤ 0.05</td> <td>3</td> <td>Ignore</td> </tr> <tr> <td>≤ 1.5</td> <td>≤ 0.075</td> <td>2</td> <td>Ignore</td> </tr> <tr> <td></td> <td>0.075 &lt;</td> <td colspan="2">Follow round type</td> </tr> </tbody> </table> <p>At (1) &amp; (2) total defect q'ty is must not exceed 5 pieces.</p>	Area Dimension***	Acceptable Q'ty		Remark	A Area	B Area	≤ 0.1	Ignore			≤ 0.2	2	Ignore	≤ 0.3	1	Ignore	0.3 <	0	Ignore	Dimension		Acceptable Q'ty		Remark	Length	Width	A Area	B Area	-	≤ 0.025	Ignore			≤ 2.5	≤ 0.05	3	Ignore	≤ 1.5	≤ 0.075	2	Ignore		0.075 <	Follow round type		MI	<p>*** : Mean Diameter (X + Y)/2</p>
Area Dimension***	Acceptable Q'ty			Remark																																													
	A Area	B Area																																															
≤ 0.1	Ignore																																																
≤ 0.2	2	Ignore																																															
≤ 0.3	1	Ignore																																															
0.3 <	0	Ignore																																															
Dimension		Acceptable Q'ty		Remark																																													
Length	Width	A Area	B Area																																														
-	≤ 0.025	Ignore																																															
≤ 2.5	≤ 0.05	3	Ignore																																														
≤ 1.5	≤ 0.075	2	Ignore																																														
	0.075 <	Follow round type																																															
6	OC Spot	<table border="1"> <thead> <tr> <th rowspan="2">Area Dimension***</th> <th colspan="2">Acceptable Q'ty</th> <th rowspan="2">Remark</th> </tr> <tr> <th>A Area</th> <th>B Area</th> </tr> </thead> <tbody> <tr> <td>≤ 0.2</td> <td colspan="2">Ignore</td> <td rowspan="3"></td> </tr> <tr> <td>≤ 0.8</td> <td>3</td> <td>Ignore</td> </tr> <tr> <td>≤ 1.0</td> <td>1</td> <td>Ignore</td> </tr> </tbody> </table>	Area Dimension***	Acceptable Q'ty		Remark	A Area	B Area	≤ 0.2	Ignore			≤ 0.8	3	Ignore	≤ 1.0	1	Ignore	MI																														
Area Dimension***	Acceptable Q'ty			Remark																																													
	A Area	B Area																																															
≤ 0.2	Ignore																																																
≤ 0.8	3	Ignore																																															
≤ 1.0	1	Ignore																																															
7	Air Bubbles Between Glass & Polarizer (Polarizer Defects)	<table border="1"> <thead> <tr> <th rowspan="2">Area Dimension***</th> <th colspan="2">Acceptable Q'ty</th> <th rowspan="2">Remark</th> </tr> <tr> <th>A Area</th> <th>B Area</th> </tr> </thead> <tbody> <tr> <td>≤ 0.15</td> <td colspan="2">Ignore</td> <td rowspan="5"></td> </tr> <tr> <td>≤ 0.3</td> <td>3</td> <td>Ignore</td> </tr> <tr> <td>≤ 0.5</td> <td>2</td> <td>Ignore</td> </tr> <tr> <td>≤ 0.7</td> <td>1</td> <td>Ignore</td> </tr> <tr> <td>Total</td> <td>5</td> <td>Ignore</td> </tr> </tbody> </table>	Area Dimension***	Acceptable Q'ty		Remark	A Area	B Area	≤ 0.15	Ignore			≤ 0.3	3	Ignore	≤ 0.5	2	Ignore	≤ 0.7	1	Ignore	Total	5	Ignore	MI																								
Area Dimension***	Acceptable Q'ty			Remark																																													
	A Area	B Area																																															
≤ 0.15	Ignore																																																
≤ 0.3	3	Ignore																																															
≤ 0.5	2	Ignore																																															
≤ 0.7	1	Ignore																																															
Total	5	Ignore																																															

Date : Apr. 18, 2008

TECHNICAL SPECIFICATION

**HYES**

LCM

HT2204L

Page 19 of 24

(3.3) Appearance Spec

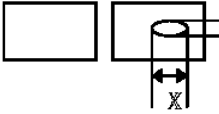
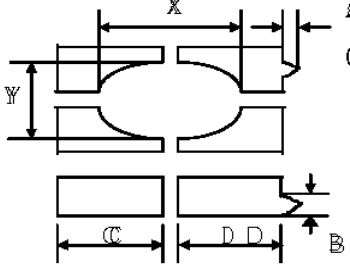
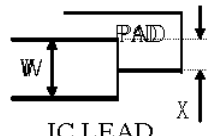
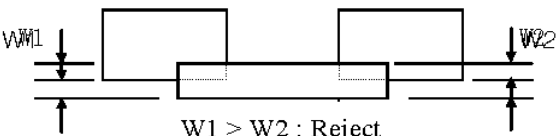
No	Item	Criteria	Rank	Remark								
8	Pin hole (On Segment)	 <p> <math>(X+Y)/2 \leq 0.2\text{mm}</math>                      Within 1 per one segment (Less than 0.1mm is not counted)                      Total defects q'ty is must not exceed 5 pieces.                 </p>	MI									
9	Segment Deformation	 <p> <math>(X+Y)/2 \leq 0.2\text{mm}</math>  <math>A \leq 0.2\text{mm}</math>  <math>B \leq 0.2\text{mm}</math>  <math>(C-D) \leq 0.2\text{mm}</math> </p> <table border="1" data-bbox="518 846 1161 990"> <thead> <tr> <th></th> <th>Acceptable Q'ty</th> </tr> </thead> <tbody> <tr> <td>Dot, Segment</td> <td>1</td> </tr> <tr> <td>LCD</td> <td>5</td> </tr> <tr> <td><math>\leq 0.1</math></td> <td>Ignore all defect</td> </tr> </tbody> </table> <p>Each visible dot must be more than half effective dot area</p>		Acceptable Q'ty	Dot, Segment	1	LCD	5	$\leq 0.1$	Ignore all defect	MI	$(X + Y)/2 \leq 0.2\text{mm}$
	Acceptable Q'ty											
Dot, Segment	1											
LCD	5											
$\leq 0.1$	Ignore all defect											
10	Color Variation	Within the three colors, except LCD Standard color is acceptable.	MI									
11	Glass & Polarizer Scratch	Follow NO.5(2) condition	MI									
12	Solder Ball	1)Acceptable if the size of void is less than 0.18mm 2)Acceptable if a solder ball is not movable 3)Rejectable if the solder ball exceed SEA in $2.54 \times 2.54\text{mm}$ area.	MI									
13	Miss Alignment	1)Acceptable if it dose not exceed 50% of the lead width IC.  <p> <math>X \leq W/2</math> : Accept  <math>X &gt; W/2</math> : Reject                 </p> 2)Rejectable, provided that it does exceed 50% of the component termination width.  <p> <math>W1 &gt; W2</math> : Reject                 </p>										

Note : A limitation sample is given top priority

Date : Apr. 18, 2008

TECHNICAL SPECIFICATION



**HYES**

LCM

HT2204L

Page 20 of 24

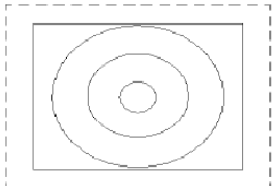
(3.3) Appearance Spec

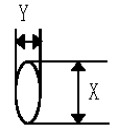
No	Item	Criteria	Rank	Remark																																																
14	Touch Panel	<p>1) Round Type、 Foreign Substances</p> <table border="1"> <thead> <tr> <th rowspan="2">Area Dimension**</th> <th colspan="2">Acceptable Q'ty</th> <th rowspan="2">Remark</th> </tr> <tr> <th>A Area</th> <th>B Area</th> </tr> </thead> <tbody> <tr> <td>≤ 0.1</td> <td colspan="2">Ignore</td> <td rowspan="4"></td> </tr> <tr> <td>≤ 0.2</td> <td>2</td> <td>Ignore</td> </tr> <tr> <td>≤ 0.3</td> <td>1</td> <td>Ignore</td> </tr> <tr> <td>0.3 &lt;</td> <td>0</td> <td>Ignore</td> </tr> </tbody> </table> <p>2) Liner Type &amp; Scratch</p> <table border="1"> <thead> <tr> <th colspan="2">Dimension</th> <th colspan="2">Acceptable Q'ty</th> <th rowspan="2">Remark</th> </tr> <tr> <th>Length</th> <th>Width</th> <th>A Area</th> <th>B Area</th> </tr> </thead> <tbody> <tr> <td>-</td> <td>W ≤ 0.025</td> <td colspan="2">Ignore</td> <td rowspan="6">Ignore</td> </tr> <tr> <td>L ≤ 3.0</td> <td rowspan="2">W ≤ 0.05</td> <td colspan="2">Ignore</td> </tr> <tr> <td>3.0 &lt; L ≤ 5.0</td> <td colspan="2">2</td> </tr> <tr> <td>≤ 7</td> <td>W ≤ 0.1</td> <td colspan="2">1</td> </tr> <tr> <td>-</td> <td>W &gt; 0.1</td> <td colspan="2">Follow round type</td> </tr> </tbody> </table> <p>4) Newton Ring</p> <p>a) Regular</p>  <p>The area of the Newton ring is more than 1/3 area of the touch panel It's NG. The area of the Newton ring is less than 1/3 area of the touch panel It's OK.</p> <p>b) None-regularity</p>  <p>The area of the Newton ring is more than 1/2 area of the touch panel It's NG. The area of the Newton ring is less than 1/2 area of the touch panel It's OK.</p>	Area Dimension**	Acceptable Q'ty		Remark	A Area	B Area	≤ 0.1	Ignore			≤ 0.2	2	Ignore	≤ 0.3	1	Ignore	0.3 <	0	Ignore	Dimension		Acceptable Q'ty		Remark	Length	Width	A Area	B Area	-	W ≤ 0.025	Ignore		Ignore	L ≤ 3.0	W ≤ 0.05	Ignore		3.0 < L ≤ 5.0	2		≤ 7	W ≤ 0.1	1		-	W > 0.1	Follow round type		MI	 <p>** : Mean Diameter (X + Y)/2</p>
Area Dimension**	Acceptable Q'ty			Remark																																																
	A Area	B Area																																																		
≤ 0.1	Ignore																																																			
≤ 0.2	2	Ignore																																																		
≤ 0.3	1	Ignore																																																		
0.3 <	0	Ignore																																																		
Dimension		Acceptable Q'ty		Remark																																																
Length	Width	A Area	B Area																																																	
-	W ≤ 0.025	Ignore		Ignore																																																
L ≤ 3.0	W ≤ 0.05	Ignore																																																		
3.0 < L ≤ 5.0		2																																																		
≤ 7	W ≤ 0.1	1																																																		
-	W > 0.1	Follow round type																																																		

Date : Apr. 18, 2008

TECHNICAL SPECIFICATION

**HYES**

LCM

HT2204L

Page 21 of 24

#### (4.0) Reliability Condition

Item	Content
Room Temperature Operation	50,000 hrs

#### (4.1) Reliability Test - Module Middle Reliability

No.	Item	Condition	Test Time	Sample Numbers	Criteria (Acc/Rej)	Note
1	High Temp Operation	70 ± 2 °C	120 hrs	3	0/1	
2	Low Temp Operation	-20 ± 2 °C	120 hrs	3	0/1	
3	High Humidity Storage	60 °C 90%rh	120 hrs	3	0/1	
4	Thermal Shock	30mn stage -20 °C ↔70 °C	100 cycles /6days	3	0/1	

#### (4.2) Criteria

- a. No changes for indication and appearance.
- b. Leave the all samples under room temperature 4 hours after reliability test ends.

Date : Apr. 18, 2008

TECHNICAL SPECIFICATION

**HYES**

LCM

HT2204L

Page 22 of 24

## 10. LCD Module Operation Instruction

### Part I. How to use the LCD Module

1. Don't hit the LCD Panel in any way because the LCD is made of glass.
2. Don't clean the surface of LCD with hard things. Please clean LCD with Air-gun or very soft cloth when necessary. The protective film on the POL can be removed just before assembly, otherwise, dust, spit or other foreign matter may attached on the LCD under the protective film. After the protective film is removed, only air-gun can be used to remove any dust or foreign matter. Fingure or cloth MUST NOT be used in such cases.
3. No chemical liquid is allowed to clean the LCD, such as alcohol, acetone and IPA. All of these candamage the LCD. Water on the LCD must be cleaned as soon as possible, for it will cause POL color change or other defect.
4. Please move and assemble LCD very carefully during assembly, and don't push or twist it.
5. Don't damage the FPC of LCD module. It will cause permanent defect.
6. Don't disassemble LCD module. It will cause permanent defect.
7. Don't expose LCD module under sunshine, strong fluorescence or ultraviolet radiation.
8. Please make sure that operators wear static-protective bands effectively and working tables are effectively earthing during operation.
9. Please place LCD module on the tray provided by HYES while moving it, in order to avoid mechanical damage. Hold the module's side frames to avoide damage during moving.
10. Don't twist, disassemble, squeeze or hit the PCB. It will damage the circuit or component on PCB and cause functional defect.
11. Please use the connector according to the instruction provided by HYES.
12. Please place dual module with the sub-panel upward. Trays should be placed in contrary direction. An empty tray should be placed on the top.
13. Sealing operation on PCB must be very careful to avoid short or cut the original circuit on PCB. Otherwise, it will cause permanant damage to the LCD.
14. Don't add direct DC or high voltage to LCD panel. It will cause functional damage to the LCD or shorten the life of LCD product.
15. LCD may respond slowly or display abnormally in extrem temperature (lower than -20°C or higher than 50°C). But this doesn't mean LCD functional defect. LCD will display normally in regular temperature. Therefore, don't use LCD product in extrem temperature.

Date : Apr. 18, 2008

TECHNICAL SPECIFICATION

**HYES**

LCM

HT2204L

Page 23 of 24

- 16. Don't push the display area of LCD panel, it will cause abnormal display. This doesn't mean LCD functional defect, neither. LCD will display normally in regular temperature.
- 17. Electrical test of LCD product is made by using mobile phone provided by Customer. We can use special test equipment to do the test, also.
- 18. The black band on IC on LCD product is used to protect the IC from light. Please do NOT remove it.
- 19. Please take great care to use connector. Customer should be responsible for connector defect caused by operation on Customer side.

**Part II Storage**

- 1. Physical status of liquid crystal will change in extrem temperature, and it can not be resumed when the temperature returns to be normal. So LCD module should be stored in required temperature.
- 2. LCD module should be stored in required humidity. Low humidity may add static, while high humidity may corrode the ITO circuit of LCD product. The suitable storage environment is: temperature:  $22\pm 5^{\circ}\text{C}$ , humidity:  $55\%\pm 10\%$ .
- 3. Don't expose LCD module under sunshine, strong fluorescence or ultraviolet radiation for a long time. It should be stored in dark area.
- 4. LCD should be stored in static-protective polythene bag. Don't expose it in the air for a long time.

Date : Apr. 18, 2008		TECHNICAL SPECIFICATION	
	LCM	HT2204L	Page 24 of 24