

Dye Sensitised Indoor Photovoltaic Module

Indy4050 data sheet

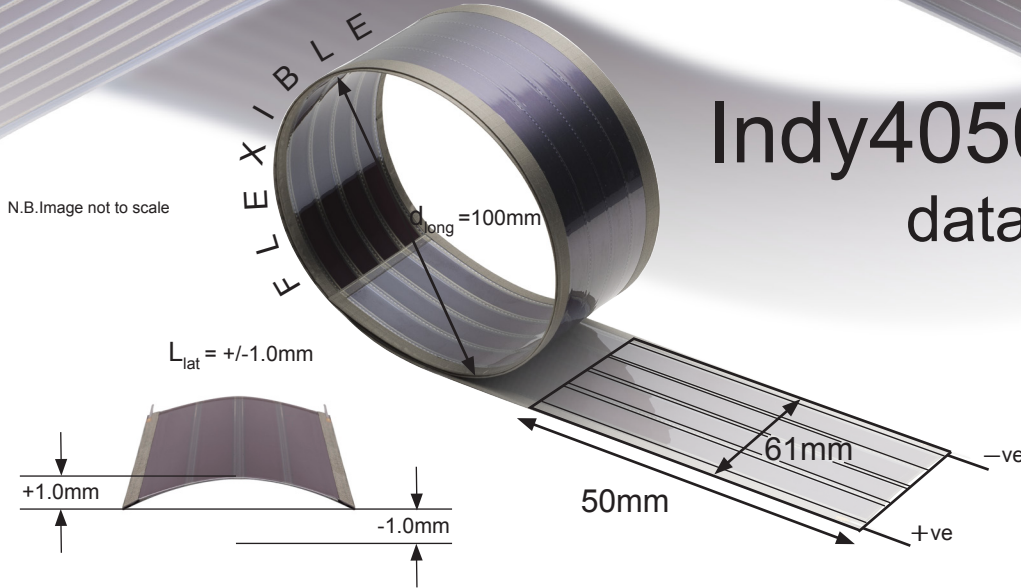

Power connections are suitable for crimp connection or soldered connection with the appropriate use of heat-shunt tweezers to ensure minimal heating of the polymer material.

Parameter	Symbol	Condition	Typical	Minimum	Maximum	Units
Open circuit voltage	Voc	200 lux	2.25	2.21	2.30	V
		1000 lux	2.51	2.46	2.56	
Short circuit current	Isc	200 lux	56	53	59	µA
		1000 lux	256	243	269	
Operating voltage	Vop	200 lux	1.81	1.71	1.91	V
		1000lux	2.02	1.99	2.06	
Operating current	Iop	200 lux	49	43	56	µA
		1000 lux	231	219	242	
Thickness	d	-	0.35	-	-	mm
Mass	M	-	0.06	-	-	gcm ⁻²

F36W-827 Fluorescent tubes

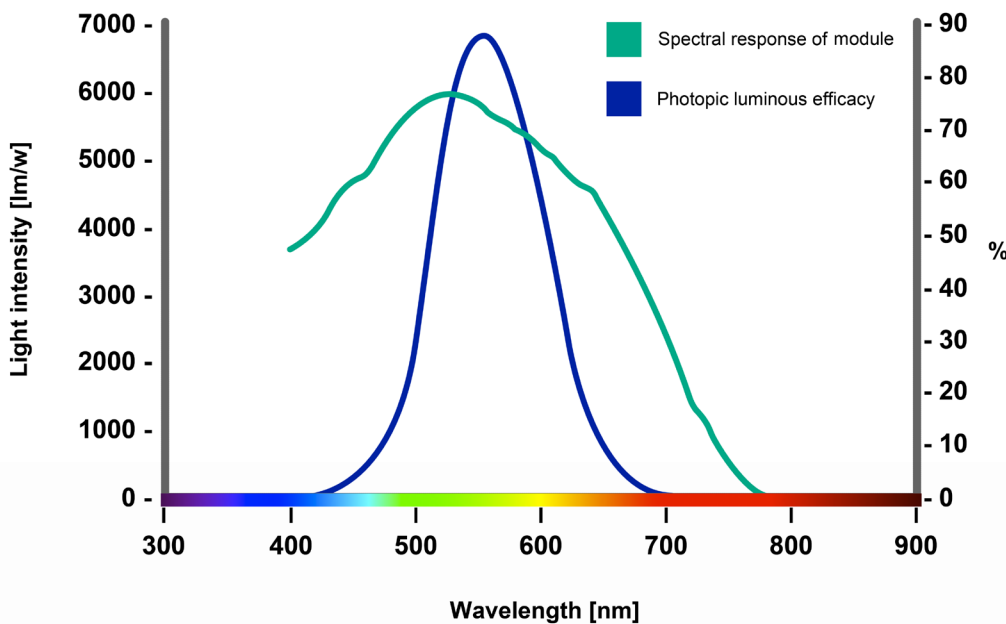

G24i's dye sensitised indoor photovoltaic modules have been optimised to work under indoor lighting providing the highest power density.

This evaluation module is intended for development, demonstration or evaluation purposes only. G24i does not provide this module as a finished product fit for general use. Persons handling the module must have electronics training and observe good engineering practice standards. G24i reserves the right to change the module specification at any time.

N.B.

All dimensional measurements shown are approximate.

Performance specifications shown maybe subject to variation.

Physical Characteristics maybe subject to change.

Longitudinal bend diameter spec (d_{long})

Lateral bend limit spec (L_{lat})

All samples supplied are prototype subject to customer specification.