

PLC Connection Guid

Altus ALNET-I.....	2	Hitachi H/EH/EHV Series	131
BACnet BACnet/IP	6	HUST H4X.....	138
Barcode (USB/COM)	17	IAI X-SEL CONTROLLER.....	140
Baumuller	19	IDEC Micro	143
Beckhoff ADS/AMS (Ethernet).....	22	Inovance H2U/H1U	147
Beckhoff Embedded PC.....	29	Justfi Controller	150
CANopen Slave (for eMT3000 only).....	36	Kernel sistemi DMX Series.....	152
Change.....	39	KEYENCE KV-10/16/24/40/80/Visual KV Series..	154
Cimon CM1-CP4A/ECO1A	41	KEYENCE KV-5000 (Ethernet)	157
Cimon CM1-SC02A	43	KEYENCE KV-700/1000/3000/5000 Series.....	159
Copley Controls.....	45	Korenix 6550.....	161
CROUZET M3 (FBD).....	49	KOYO CLICK.....	163
CROUZET M3 (LAD)	52	KOYO DIRECT	166
Danfoss ECL Apex20	55	KOYO Ethernet.....	178
Danfoss ECL Apex20 (Ethernet).....	58	Lenze.....	181
Danfoss FC Series.....	60	LingYan BMS	183
Danfoss VLT2800 Series	62	LIYAN EX series	185
DELTA DVP	64	LoXin.....	187
DELTA DVPEN01-SL (Ethernet)	66	LS GLOFA Cnet.....	189
DL/T645 CHUANG HONG.....	68	LS GLOFA FEnet (Ethernet).....	194
DL/T645 Standard	74	LS GLOFA GM3467 (LOADER)	196
DL-BCM Server	76	LS MASTER-K Cnet	198
EMERSON Charge Module.....	79	LS MASTER-K CPU Direct.....	200
EMERSON PLC EC20	81	LS MASTER-K MODBUS RTU.....	202
FATEK FB Series.....	83	LS MASTER-K10S1	204
Fuji NB Series.....	89	LS XECH Cnet	206
GE Fanuc 0i MD.....	92	LS XECH FEnet (Ethernet)	209
GE Fanuc CMM.....	95	LS XGB Cnet	211
GE Fanuc RX3i	100	LS XGB FEnet (Ethernet)	214
GE Fanuc Series 90-30 (Ethernet)	104	LS XGI Cnet	217
GE Fanuc SNP-X.....	107	LS XGI CPU DIRECT.....	221
Haiwell PLC.....	112	LS XGI FEnet (Ethernet)	224
Hangzhou Maiou MO-TECH.....	115	LS XGK Cnet.....	226
Hanyoung Controller	117	LS XGK FEnet (Ethernet).....	230
HAWE PLVC	120	LS XGT/XGK CPU DIRECT	233
Heng Yuan EU series	122	LS Mecapion Metronix AnyPack.....	236
Hitachi EH-SIO	124	Master-Slave Server	238
Hitachi EHV Series (Ethernet).....	129	Memory Map	241

MIKOM MX Series PLC	245	Moeller XC-CPU101	401
Mitsubishi A1S/A2N	248	OHJX	403
Mitsubishi A2A/A2U/A2AS/A2USH	251	OMRON C/CQM1 Series	406
Mitsubishi A3A/A3N/A1SH/A2SH	254	OMRON CJ/CS/CP	410
Mitsubishi A2US	257	OMRON CJ1/CS1 (Ethernet)	414
Mitsubishi AJ71	260	OMRON E5CN/E5EZ/E5ZN	416
Mitsubishi AJ71 (AnA/AnU CPU)	264	OMRON FINS (Ethernet)	420
Mitsubishi AJ71 (Format 4)	268	OMRON Host Link	422
Mitsubishi F930GOT Server	272	Panasonic FP	426
Mitsubishi FX0s/FX0n/FX1s/FX1n/FX2	275	Panasonic FP (Ethernet)	434
Mitsubishi FX232/485BD	279	Panasonic FP2 (Ethernet)	437
Mitsubishi FX2n	284	Panasonic MINAS A4	439
Mitsubishi FX3u (Ethernet)	287	Panasonic MINAS A5	443
Mitsubishi FX3u/FX3G	294	Parker ACR9000	447
Mitsubishi MELSEC-Q/L - ASCII Mode (Ethernet)	297	Parker Compax3	449
Mitsubishi MELSEC-Q/L - Binary Mode (Ethernet)	302	Parker Compumotor 6K Series	454
Mitsubishi MR J3 A	307	Parker SLVD Series	456
Mitsubishi MR-MQ100 (Ethernet)	314	Rockwell CompactLogix - Free Tag Names	459
Mitsubishi Q00/Q00UJ/Q01/QJ71	317	Rockwell CompactLogix/FlexLogix	467
Mitsubishi Q00J	326	Rockwell DF1	471
Mitsubishi Q00U/Q01U/Q02U/QnUD/QnUDH	328	Rockwell DF1 (BCC)	475
Mitsubishi Q00UJ/QnU/QnUD/QnUDH/QnUDEH/L (mini USB)	331	Rockwell DH485	479
Mitsubishi Q02/02H	333	Rockwell EtherNet/IP (CompactLogix)	484
Mitsubishi Q06H	336	Rockwell EtherNet/IP (CompactLogix) – Free Tag Names	487
Mitsubishi QJ71E71 (Ethernet)	339	Rockwell EtherNet/IP (ControlLogix) – Free Tag Names	495
MODBUS ASCII	346	Rockwell EtherNet/IP (DF1)	503
MODBUS ASCII Server	351	Rockwell PLC5	506
MODBUS RTU	355	RS Automation OEMAX Series	510
MODBUS RTU (0x/1x Range Adjustable)	360	SAIA PCD PGU Mode	512
MODBUS RTU (Adjustable)	369	SAIA PCD S-BUS Mode	514
MODBUS RTU (zero-based addressing)	376	SAIA S-BUS (Ethernet)	522
MODBUS Server (COM/Ethernet)	381	Samsung SPC-10	525
MODBUS TCP/IP	389	SCENE6 Controller	527
MODBUS TCP/IP (0x/1x Range Adjustable)	391	Schleicher XCS 20C	529
MODBUS TCP/IP (zero-based addressing)	397	Schleicher XCX 300	532
MODBUS TCP/IP 32Bit	399	Schneider MODBUS RTU	537
		Schneider MODBUS TCP/IP	541

Schneider UniTelway	543	TOSHIBA VF-S11.....	672
SEW Movilink	545	TOSHIBA MACHINE Provisor TC200	675
SEW MOVITRAC LTE	547	Trio MODBUS RTU, TCP/IP	678
SHIMADEN MR13/FP93	551	Trio MODBUS RTU, TCP/IP (Mode 7)	683
SHJ-A	563	VIGOR	688
SICK FLEXI SOFT	565	VIPA 200	692
Siemens LOGO (Ethernet)	567	VIPA 200 (VD any address)	695
Siemens S7-1200 (Ethernet).....	572	VIPA 200, for ex. 214-2BT10 (Ethernet)	698
Siemens S7-200	578	VIPA 300	700
Siemens S7-200 (Ethernet).....	581	VIPA 300 MPI	708
Siemens S7-200 (VD any address).....	588	VIPA 300S (Ethernet)	716
Siemens S7-200 PPI.....	591	VIPA 300S, for ex. 315-4NE12 (Ethernet).....	723
Siemens S7-300	596	XINJE XC Series	729
Siemens S7-300 MPI	604	YAMAHA ERCD	731
Siemens S7-300/ET200S (Ethernet)	612	YASKAWA CCMEP	734
Siemens S7-400 (Ethernet).....	618	YASKAWA Memobus (MP Series Controllers)	736
Siemens TI505	626	YASKAWA MP Series Ethernet (Extension)	743
Siemens TI565/C400.....	632	YASKAWA MP2300Siec	748
SSTC SSD Series	638	YASKAWA SMC 3010	757
TECHSOFT Intelligent Servo	650	YASKAWA SMC 3010 (Ethernet).....	761
TECO Inverter	652	YOKOGAWA FA-M3	764
TECO TP02 Series	655	YOKOGAWA FA-M3 (Ethernet).....	770
TECO TP03 Series	658	YUDIAN AIBUS.....	772
TINHAO	661	MT6050i/MT8050i Com Port Pin Assignment	776
Toptek Topvert.....	664		
TOSHIBA T Series.....	667		

Altus ALNET-I

Supported Series: Altus SeriesMode PO3042, PO3142, PO3242, PO3342, PL103 ,PL104, PL105, QK800, QK801, QK2000.

HMI Setting:

Parameters	Recommended	Options	Notes
PLC type	Altus ALNET-I		
PLC I/F	RS232		
Baud rate	9600		
Data bits	8		
Parity	Even		
Stop bits	1		
PLC sta. no.	0		

Device Address:

Bit/Word	Device Type	Format	Range	Memo
B	M_Bit	DDDDh	0 ~ 1023f	Memories
B	A	DDDh	0 ~ 511f	Auxiliary Relays
B	E	DDDh	0 ~ 511f	Input Relays
B	D_Bit	DDDDdd	0 ~ 102331	Decimals
B	F_Bit	DDDDdd	0 ~ 102331	Reals
B	I_Bit	DDDDdd	0 ~ 102331	Integers
B	S	DDDh	0 ~ 511f	Output Relays
W	M	DDDD	0 ~ 4096	Memories
DW	D	DDDD	0 ~ 4096	Decimals
DW	F	DDDD	0 ~ 1023	Reals
DW	I	DDDD	0 ~ 1023	Integers
W	TM	HHHH	0 ~ ffff*	Memory Tables
DW	TD	HHHH	0 ~ ffff*	Decimal Tables
DW	TF	HHHH	0 ~ ffff*	Real Tables
DW	TI	HHHH	0 ~ ffff*	Integer Tables

Note: The formats of TM, TD, TF and TI in PLC software are represented as TXA[B]. "X" can be M, D, F, or I.

The address range of B is 0~FF, and A is 0~FF. The device type is AABB, and the range depends on the PLC settings.



For example: Model PO3242, range of "A" is "0" and range of "B" is 0 ~ 7.

Wiring Diagram:





The following represents the view of HMI & PLC.

9P D-Sub to 8P RJ45: PLC PO3042, PO3142, PO3242, PO3342



eMT3000 series

COM1 RS232 9P D-Sub Female	COM3 RS232 9P D-Sub Female		PLC RS232 8P RJ45 Male
2 RX	8 RX		2 TX
3 TX	7 TX		3 RX
5 GND	5 GND		5 GND
			

MT6000/8000 series except MT6050i/MT8050i

COM1 RS232 9P D-Sub Female	COM2 RS232 9P D-Sub Female	COM3 RS232 9P D-Sub Male	PLC RS232 8P RJ45 Male
2 RX	6 RX	8 RX	2 TX
3 TX	4 TX	7 TX	3 RX
5 GND	5 GND	5 GND	5 GND
			



MT6050i/MT8050i

COM1 RS232 9P D-Sub Female			PLC RS232 8P RJ45 Male
9 RX			2 TX
6 TX			3 RX
5 GND			5 GND
			





The following represents the view of HMI & PLC.

9P D-Sub to 9P D-Sub: PLC PL103, PL104, PL105



eMT3000 series

COM1 RS232 9P D-Sub Female	COM3 RS232 9P D-Sub Female		PLC RS232 9P D-Sub Male
2 RX	8 RX		7 TX
3 TX	7 TX		1 RX
5 GND	5 GND		5 GND
			

MT6000/8000 series except MT6050i/MT8050i

COM1 RS232 9P D-Sub Female	COM2 RS232 9P D-Sub Female	COM3 RS232 9P D-Sub Male	PLC RS232 9P D-Sub Male
2 RX	6 RX	8 RX	7 TX
3 TX	4 TX	7 TX	1 RX
5 GND	5 GND	5 GND	5 GND
			



MT6050i/MT8050i

COM1 RS232 9P D-Sub Female			PLC RS232 9P D-Sub Male
9 RX			7 TX
6 TX			1 RX
5 GND			5 GND
			





The following represents the view of HMI & PLC.

9P D-Sub to 9P D-Sub: PLC QK800, QK801, QK2000.



eMT3000 series

COM1 RS232 9P D-Sub Female	COM3 RS232 9P D-Sub Female		PLC RS232 9P D-Sub Male
2 RX	8 RX		2 TX
3 TX	7 TX		3 RX
5 GND	5 GND		7 GND
			

MT6000/8000 series except MT6050i/MT8050i

COM1 RS232 9P D-Sub Female	COM2 RS232 9P D-Sub Female	COM3 RS232 9P D-Sub Male	PLC RS232 9P D-Sub Male
2 RX	6 RX	8 RX	2 TX
3 TX	4 TX	7 TX	3 RX
5 GND	5 GND	5 GND	7 GND
			

MT6050i/MT8050i

COM1 RS232 9P D-Sub Female			PLC RS232 9P D-Sub Male
9 RX			2 TX
6 TX			3 RX
5 GND			7 GND
			

Driver Version:

Version	Date	Description
V1.10	Jul/24/2009	

BACnet BACnet/IP

Supported series: BACnet/IP protocol devices

HMI Setting:

Parameters	Recommended	Options	Notes
PLC type	BACnet/IP		
PLC I/F	Ethernet		
Port no.	47808		
HMI port no.	47808	47808~47823	
Device ID	342566	0~999999	According to device.
PLC sta. no.	1		

BACnet/IP to MS/TP Adapter Setting:

1. When using BACnet/IP driver, check **“Use [BACnet/IP to MS/TP Adapter]”** to enable this type of communication.

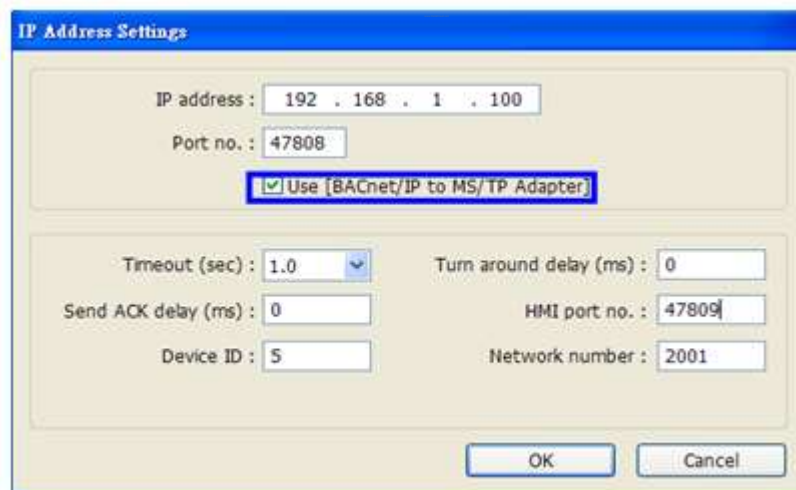

2. As shown above, in BACnet/IP to MS/TP Adapter mode, [Network number] must follow the factory setting, and enter the device station number in [Device ID].

3. [HMI port no]. default: 47808, can be filled in other effective value.

How to Import Tags:

EasyBuilder Pro provides two ways to gain tag addresses. One is to directly get tag information via internet, another is to export the generated CSV file via SCADA, and then import to EasyBuilder Pro. The following introduces how to import tag address information.

Step 1. Add BACnet/IP driver in System Parameters Settings

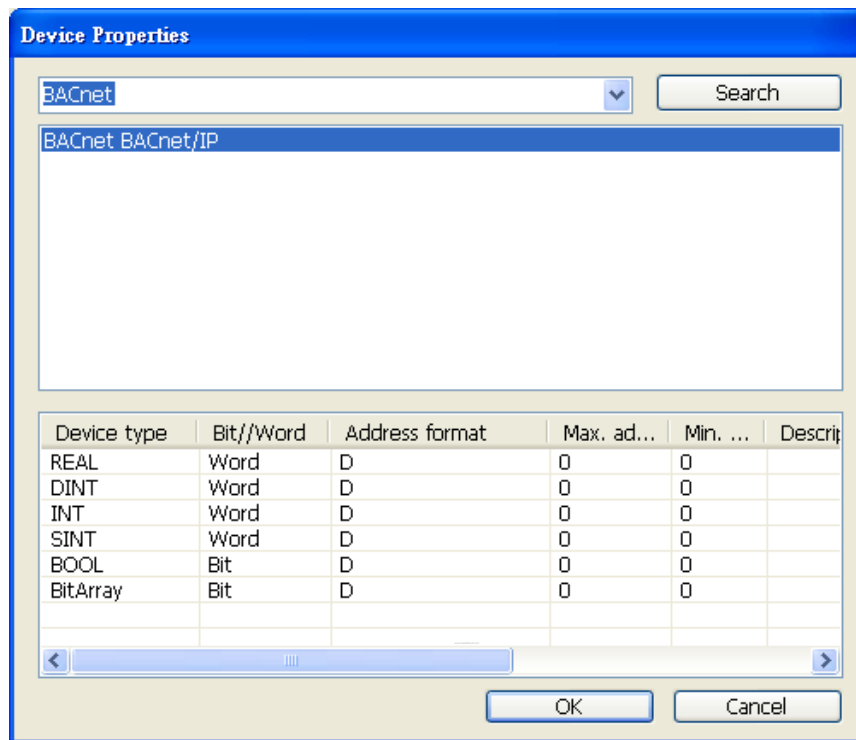

Step 2. Correctly set the relevant parameters.

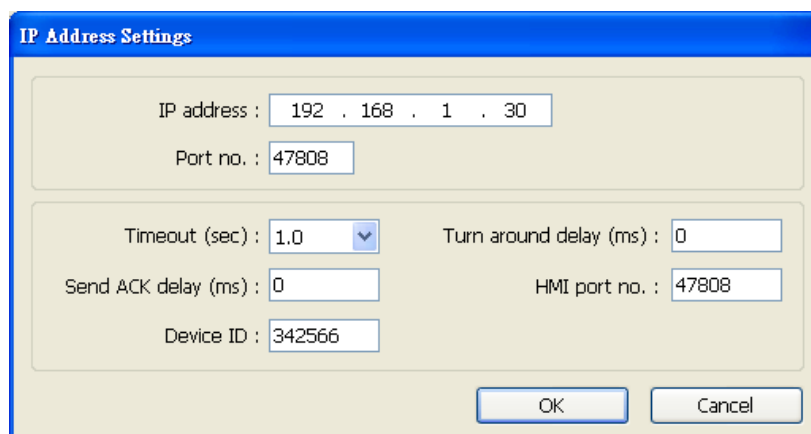

Step 3. Get tag address information

Way 1: Click **Get Tag Info**.

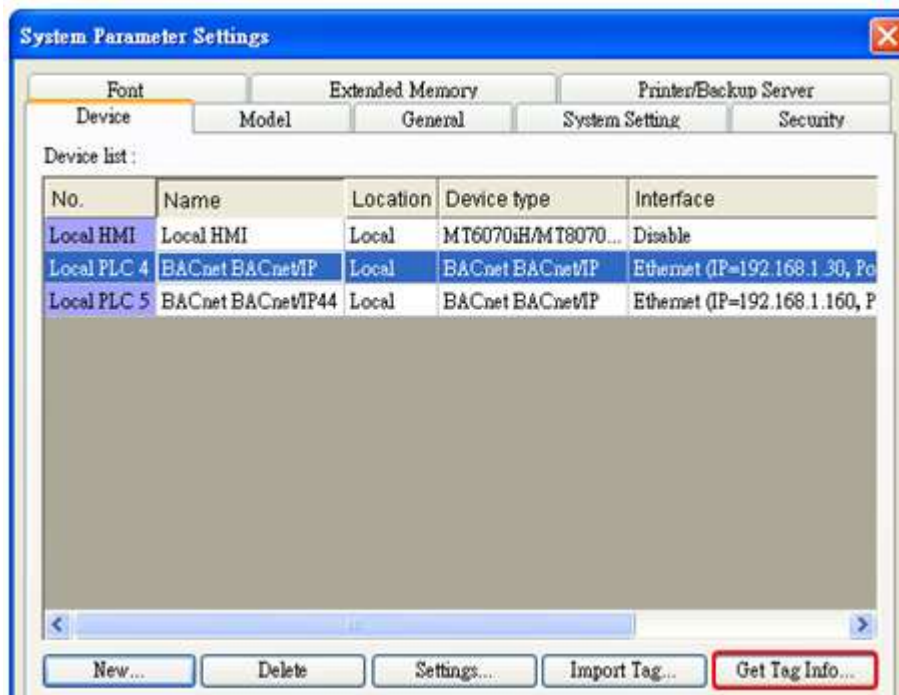

Way 2: Import the CSV file generated by SCADA software.

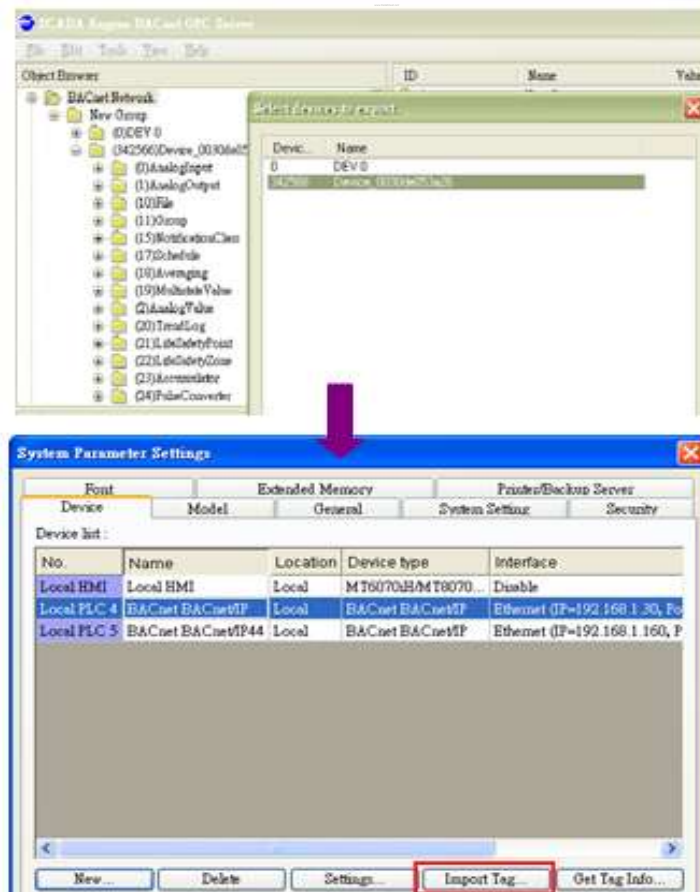

CSV file content is shown below; users can build the file and import:

- a. Object format
- b. OBJECT NAME (user defined tag name, EasyBuilder will start reading data from the 6th row of CSV file.), DEVICE ID, OBJECT TYPE(object ID) and INSTANCE(object address)

A1		A GROUP_ID	
A	B	C	D
1	GROUP_ID	GROUP_NAME	
2		1 New Group	
3	DEVICE_ID	GROUP_ID	DEVICE_NAME
4	342566	1	Device_0030de053a26
5	DEVICE_ID	OBJECT_TYPE	INSTANCE
6	342566	0	0 ANALOG_INPUT_0
7	342566	0	1 ANALOG_INPUT_1
8	342566	0	2 ANALOG_INPUT_2
9	342566	1	0 ANALOG_OUTPUT_0
10	342566	1	1 ANALOG_OUTPUT_1
11	342566	1	2 ANALOG_OUTPUT_2
12	342566	2	0 ANALOG_VALUE_0
13	342566	2	1 ANALOG_VALUE_1
14	342566	2	2 ANALOG_VALUE_2
15	342566	2	3 ANALOG_VALUE_3
16	342566	3	0 BINARY_INPUT_0
17	342566	3	1 BINARY_INPUT_1
18	342566	3	2 BINARY_INPUT_2
19	342566	3	3 BINARY_INPUT_3
20	342566	3	4 BINARY_INPUT_4
21	342566	3	5 BINARY_INPUT_5

Step 4. File imported successfully.

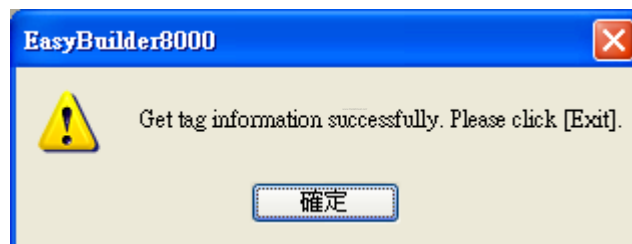

Take **(10, 2)File** as an example, **10** represents object ID, **2** represents object address, **File** represents user defined name or default name.

Name	Data Type	Description
[-] Controller Tags		
[-] (8,342566)Device	Device	
[-] (10,2)File	File	
[-] (10,3)File	File	
[-] (10,4)File	File	
[-] (10,8)File	File	
[-] (10,9)File	File	
[-] (10,10)File	File	
[-] (10,5)File	File	
[-] (10,6)File	File	
[-] (10,7)File	File	
[-] (17,0)Schedule	Schedule	
[-] (6,0)Calendar	Calendar	
[-] (3,0)BinaryInput	BinaryInput	
[-] (3,1)BinaryInput	BinaryInput	
[-] (4,0)BinaryOutput	BinaryOutput	
[-] (4,1)BinaryOutput	BinaryOutput	
[-] (4,2)BinaryOutput	BinaryOutput	

Tag : (10,2)File - OK Cancel

Default Object Model:

Object ID	Object Name	Object Structure
0	Analog Input	Object Name Object Identifier Object Type Present Value Event State Out Of Service Units Min Press Value Max Press Value Cov Increment Resolution High Limit Low Limit Dead Band Profile Name
1	Analog Output	Object Name Object Identifier Object Type Present Value Event State Out Of Service Units Relinquish Default Min Press Value Max Press Value Cov Increment Resolution High Limit Low Limit Dead Band Profile Name
2	Analog Value	Object Name Object Identifier Object Type Present Value Event State

Object ID	Object Name	Object Structure
		Out Of Service Units Relinquish Default Cov Increment High Limit Low Limit Dead Band Profile Name
3	Binary Input	Object Name Object Identifier Object Type Present Value Event State Out Of Service Polarity Profile Name Notify Type Alarm Value
4	Binary Output	Object Name Object Identifier Object Type Present Value Event State Out Of Service Polarity Profile Name Notify Type
5	Binary Value	Object Name Object Identifier Object Type Present Value Event State Out Of Service Profile Name Notify Type Alarm Value
6	Calendar	Object Name Object Identifier

Object ID	Object Name	Object Structure
		Object Type Present Value
7	Command	Object Name Object Identifier Object Type Present Value In Process All Writes Successful
8	Device	Object Name Object Identifier Object Type System Status Vendor Name Vendor Identifier Model Name Firmware Revision Application Software Version Protocol Version Protocol Revision Max APDU length Accepted Segmentation Supported Apdu Timeout Number Of APDU retries Data Base Revision Max Segments Accepted Day light Savings Status Apdu Segment Timeout Backup Failure Timeout
10	File	Object Name Object Identifier Object Type File Type File Size Archive Read Only
11	Group	Object Name Object Identifier Object Type

Object ID	Object Name	Object Structure
13	Multi State Input	Object Name Object Identifier Object Type Present Value Event State Out Of Service Reliability Number Of States Time Delay Notification Class Notify Type Profile Name
14	Multi State Output	Object Name Object Identifier Object Type Present Value Event State Out Of Service Reliability Number Of States Time Delay Notification Class Notify Type Profile Name
15	Notification Class	Object Name Object Identifier Object Type Notification Class Priority
17	Schedule	Object Name Object Identifier Object Type Present Value Priority For Writing Reliability Out Of Service
18	Averaging	Object Name Object Identifier

Object ID	Object Name	Object Structure
		Object Type Minimum Value Average Value Maximum Value Attempted Samples Valid Samples Window Interval Window Samples
19	Multi State Value	Object Name Object Identifier Object Type Present Value Event State Out Of Service Reliability Number Of States Notification Class Notify Type Profile Name Time Delay
20	Trend Log	Object Name Object Identifier Object Type Enable Stop When Full Buffer Size Record Count Total Record Count
21	Life Safety Point	Object Name Object Identifier Object Type Present Value Tracking Value Event State Reliability Out Of Service Mode Silenced

Object ID	Object Name	Object Structure
22	Life Safety Zone	Object Name Object Identifier Object Type Present Value Tracking Value Event State Reliability Out of Service Mode Silenced
23	Accumulator	Object Name Object Identifier Object Type Present Value Event State Out Of Service Scale Units Reliability
24	Pulse Converter	Object Name Object Identifier Object Type Present Value Event State Out Of Service Units Scale Factor Adjust Value High Limit Low Limit Dead Band Cov Increment Count

Note 1. Object name can not include "#".

Wiring Diagram:

Direct connect (crossover cable):

HMI RJ45 Male	Wire Color	Wire Color	PLC RJ45 Male
1 TX+	White/Orange	White/Green	3 RX+
2 TX-	Orange	Green	6 RX-
3 RX+	White/Green	White/Orange	1 TX+
4 BD4+	Blue	Blue	4 BD4+
5 BD4-	White/Blue	White/Blue	5 BD4-
6 RX-	Green	Orange	2 TX-
7 BD3+	White/Brown	White/Brown	7 BD3+
8 BD3-	Brown	Brown	8 BD3-



Through a hub:

HMI RJ45 Male	Wire Color	Wire Color	PLC RJ45 Male
1 TX+	White/Orange	White/Orange	1 TX+
2 TX-	Orange	Orange	2 TX-
3 RX+	White/Green	White/Green	3 RX+
4 BD4+	Blue	Blue	4 BD4+
5 BD4-	White/Blue	White/Blue	5 BD4-
6 RX-	Green	Green	6 RX-
7 BD3+	White/Brown	White/Brown	7 BD3+
8 BD3-	Brown	Brown	8 BD3-



Driver Version:

Version	Date	Description
V1.00	Jan/12/2012	Driver released

Barcode (USB/COM)

HMI Setting:

Parameters	Recommended	Options	Notes
PLC type	Barcode (USB/COM)		
PLC I/F	RS232	RS232/485,USB	
Baud rate	9600	9600~115200	
Data bits	8	7,8	
Parity	None	None, Even, Odd	
Stop bits	1	1,2	
Terminator	CR/LF	CR/LF, STX/ETX, Other, None	



Device Address:

Bit/Word	Device type	Format	Range	Memo
B	FLAG	DD	0	flag
W	Barcode 0	DD	0	length
W	Barcode 1	DD	1~255	string





Wiring Diagram:

The following represents the view of HMI & PLC.



eMT3000 series

COM1 RS232 9P D-Sub Female	COM3 RS232 9P D-Sub Female		RS232 9P D-Sub FeMale
2 RX	8 RX		TXD
3 TX	7 TX		RXD
5 GND	5 GND		GND
			

MT6000/8000 series except MT6050i/MT8050i

COM1 RS232 9P D-Sub Female	COM2 RS232 9P D-Sub Female	COM3 RS232 9P D-Sub Male	RS232 9P D-Sub FeMale
2 RX	6 RX	8 RX	TXD
3 TX	4 TX	7 TX	RXD
5 GND	5 GND	5 GND	GND
			

MT6050i/MT8050i

COM1 RS232 9P D-Sub Female			RS232 9P D-Sub FeMale
9 RX			TXD
6 TX			RXD
5 GND			GND
			

Driver Version:

Version	Date	Description
V1.30	Oct/1/2010	

Baumuller

Website: <http://www.baumuller.com/>

HMI Setting:

Parameters	Recommended	Options	Notes
PLC type	Baumuller		
PLC I/F	RS485 4W		
Baud rate	19200	9600, 19200	
Data bits	8	7 or 8	
Parity	Even	Even, Odd, None	
Stop bits	1	1 or 2	
HMI sta. no.	0		
PLC sta. no.	0	Defaults	

PLC Setting:

Communication mode	RK 512 Protocol, 19200, 8, 1, Even
--------------------	------------------------------------



Device Address:

Bit/Word	Device type	Format	Range	Memo
B	DB0_bit ~ DB29_bit	DDDh	0 ~ 255f	
W	DB0 ~ DB29	DDD	0 ~ 255	



Wiring Diagram:

The following represents the view of HMI & PLC.



eMT3000 series

COM1 RS485 4W 9P D-Sub Male			Baumuller servo RS422 9P D-Sub Male
1 RX-			1 TXD-
2 RX+			9 TXD+
3 TX-			5 RXD-
4 TX+			6 RXD+
5 GND			8 GND
			

MT6000/8000 series except MT6050i/MT8050i

COM1 RS485 4W 9P D-Sub Male			Baumuller servo RS422 9P D-Sub Male
1 RX-			1 TXD-
2 RX+			9 TXD+
3 TX-			5 RXD-
4 TX+			6 RXD+
5 GND			8 GND
			

MT6050i/MT8050i

COM1 RS485 4W 9P D-Sub Female			Baumuller servo RS422 9P D-Sub Male
1 RX-			1 TXD-
2 RX+			9 TXD+
3 TX-			5 RXD-
4 TX+			6 RXD+
5 GND			8 GND
			

Driver Version:

Version	Date	Description
V1.10	Apr/17/2009	

Beckhoff ADS/AMS (Ethernet)

Supported Series: Twincat

HMI Setting:

Parameters	Recommended	Options	Notes
PLC type	Beckhoff ADS/AMS (Ethernet)		
PLC I/F	Ethernet		
Port no.	48898		
ADS port	801	801, 811, 821, 831	
PLC sta. no.	1		

PLC Setting:

Step1.

Open TwinCAT System Properties.

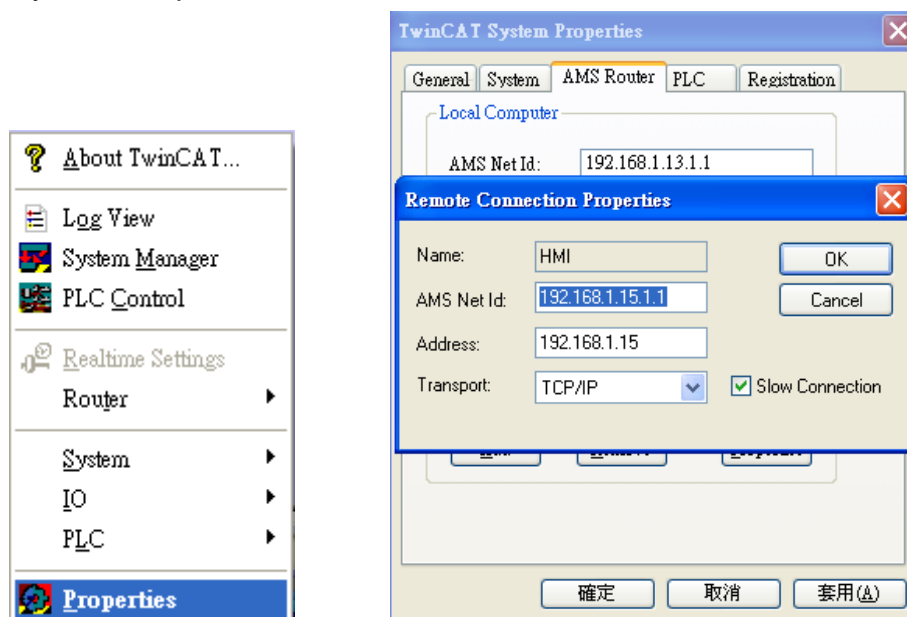

PLC Settings: Set HMI Name, AMS Net ID, and Address.

Ex:

HMI IP: 192.168.1.15

AMS Net ID: Must input 192.168.1.15.1.1

Address: 192.168.1.15

Name: Input "HMI" or any user-defined name.

Step2.

Simulate PLC on PC. 2 Twincat drivers must be installed as follows:

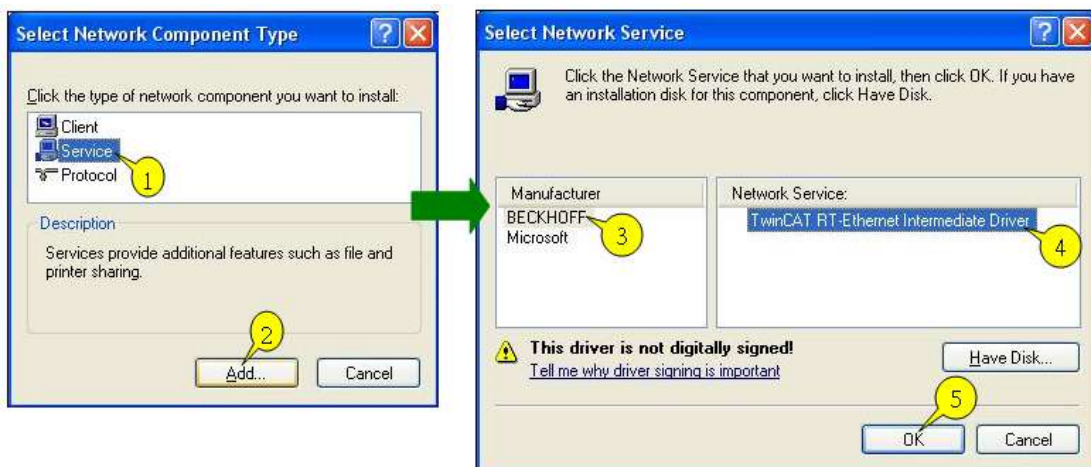
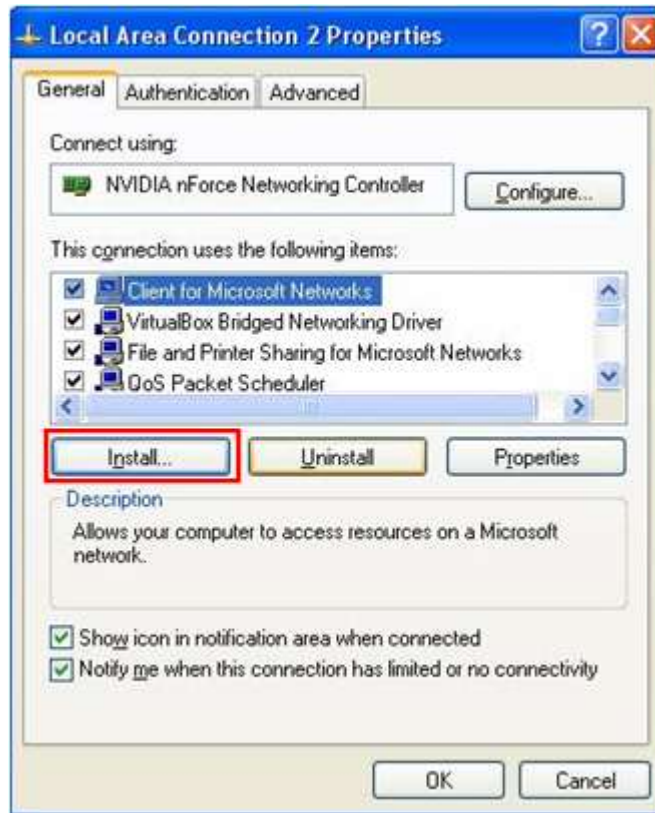

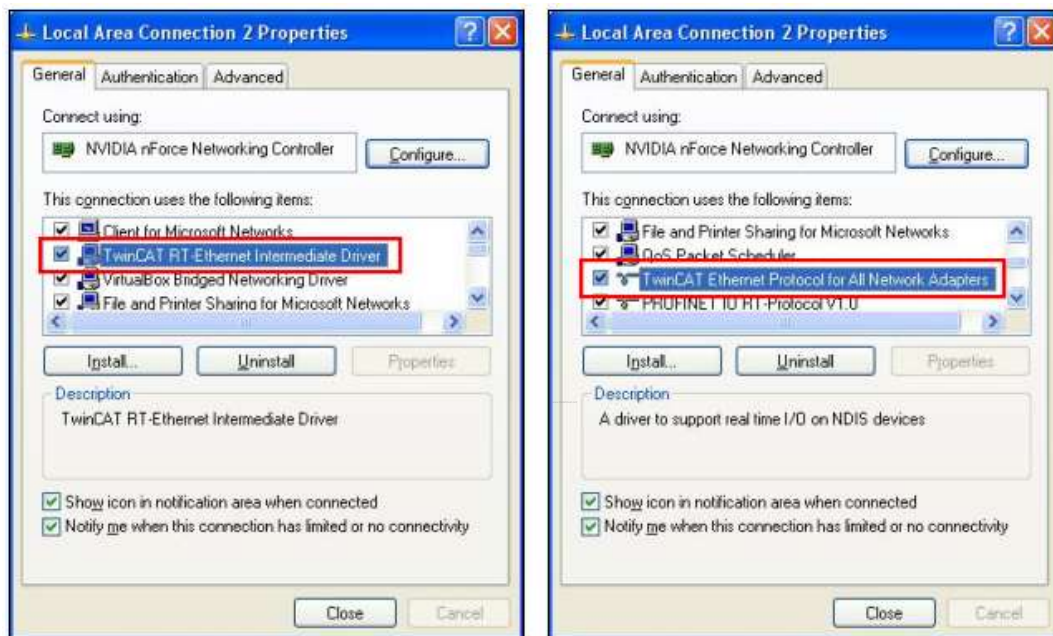
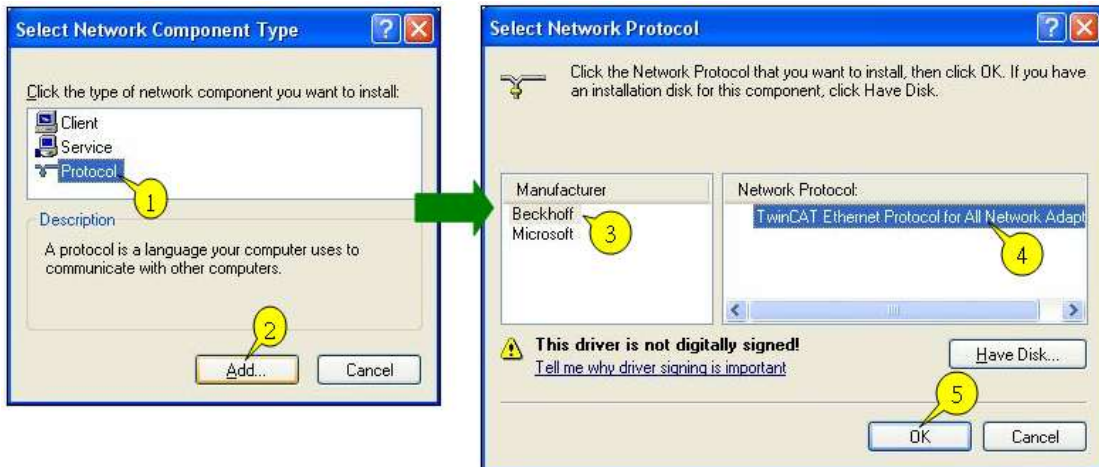

Step3.

The following commands can be utilized for Twincat PLC to output the parameters observed.

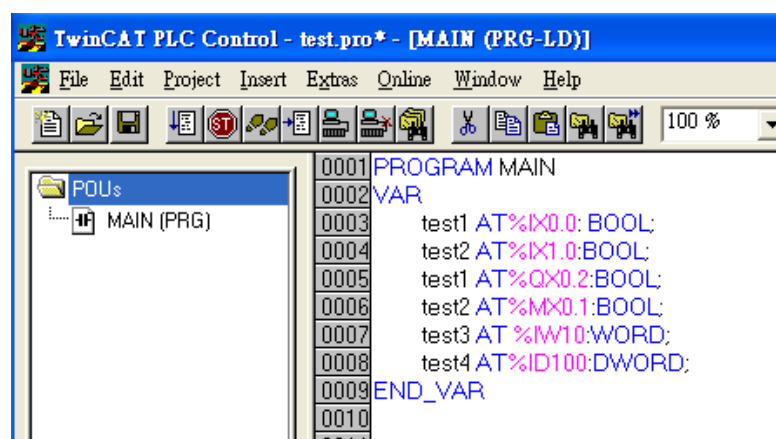
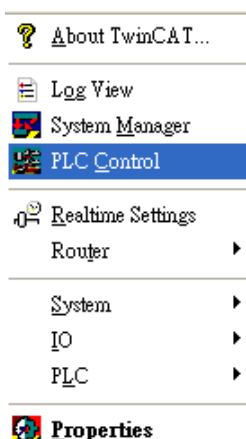

PS. TwinCAT PLC

IX, QX, MX - Must output in BOOL type.

IW, QW, MW - Must output in UINT, WORD, and INT types.

ID, QD, MD - Must output in UDINT, DWORD, and DINT types.

Project -> Rebuild all

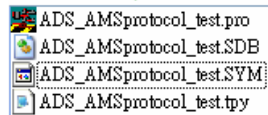
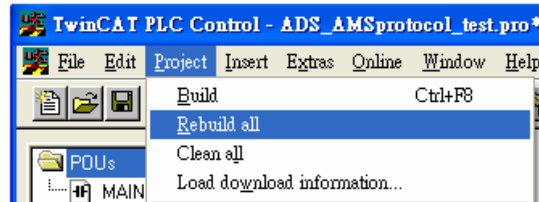

Step4. Set PLC IP in EasyBuilder.

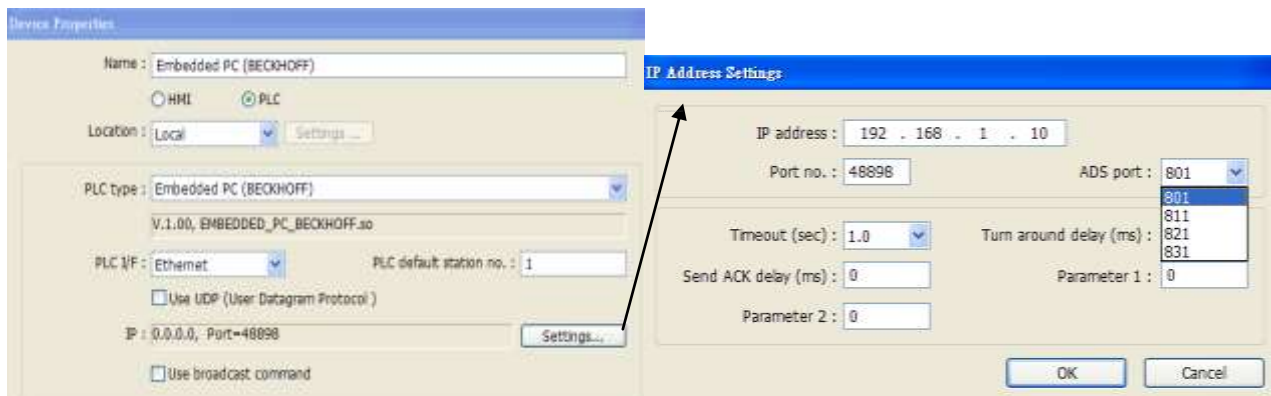

Step5.

Click [Import Tag] button in EasyBuilder to open the TPY file compiled by Twincat PLC Control.

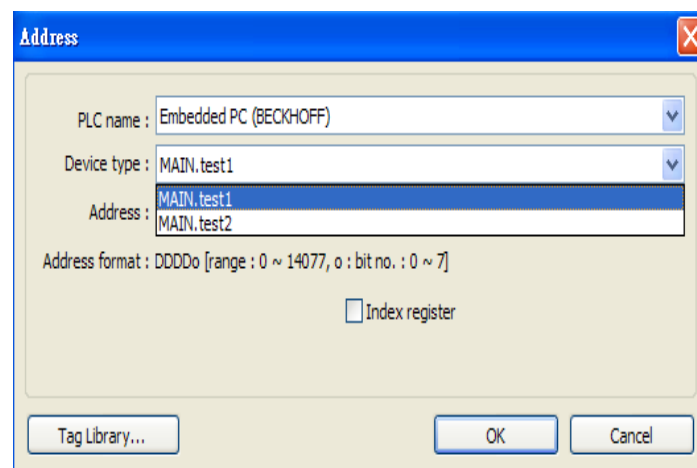
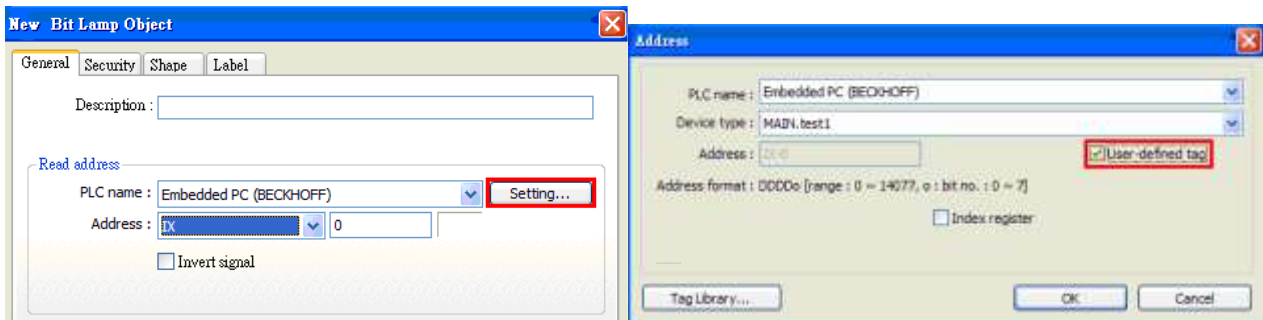
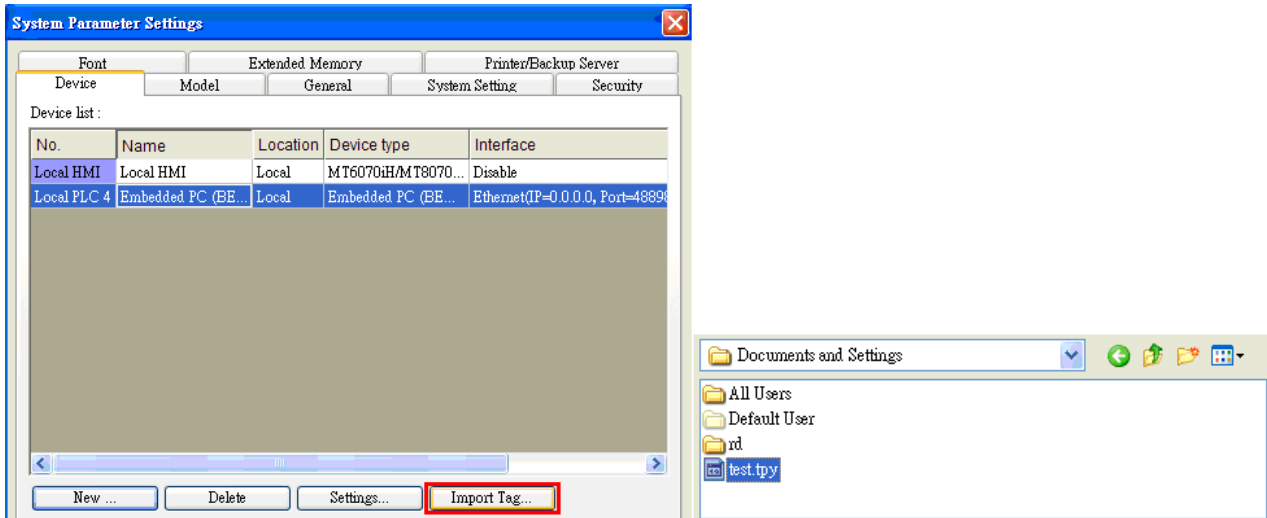

Step6.

Download the project compiled in EasyBuilder to HMI.

Device address:

Bit/Word	Device type	Format	Range	Memo
B	IX	DDDDDo	0 ~ 655357	o : Bit no.(0 ~ 7)
B	QX	DDDDDo	0 ~ 655357	o : Bit no.(0 ~ 7)
B	MX	DDDDDo	0 ~ 655357	o : Bit no.(0 ~ 7)
W	IW	DDDDD	0 ~ 65535	
W	QW	DDDDD	0 ~ 65535	
W	MW	DDDDD	0 ~ 65535	
DW	ID	DDDDD	0 ~ 65535	
DW	QD	DDDDD	0 ~ 65535	
DW	MD	DDDDD	0 ~ 65535	

Wiring Diagram:

Direct connect (crossover cable):

HMI RJ45 Male	Wire Color	Wire Color	PLC RJ45 Male
1 TX+	White/Orange	White/Green	3 RX+
2 TX-	Orange	Green	6 RX-
3 RX+	White/Green	White/Orange	1 TX+
4 BD4+	Blue	Blue	4 BD4+
5 BD4-	White/Blue	White/Blue	5 BD4-
6 RX-	Green	Orange	2 TX-
7 BD3+	White/Brown	White/Brown	7 BD3+
8 BD3-	Brown	Brown	8 BD3-



Through a hub:

HMI RJ45 Male	Wire Color	Wire Color	PLC RJ45 Male
1 TX+	White/Orange	White/Orange	1 TX+
2 TX-	Orange	Orange	2 TX-
3 RX+	White/Green	White/Green	3 RX+
4 BD4+	Blue	Blue	4 BD4+
5 BD4-	White/Blue	White/Blue	5 BD4-
6 RX-	Green	Green	6 RX-
7 BD3+	White/Brown	White/Brown	7 BD3+
8 BD3-	Brown	Brown	8 BD3-



Driver Version:

Version	Date	Description
V1.00	Dec/08/2010	Driver released.
V1.10	Aug/24/2011	Extended address range up to 65535.

Beckhoff Embedded PC

Supported Series: Intel-CX10x0,CX50x0 and Twincat

HMI Setting:

Parameters	Recommended	Options	Notes
PLC type	Beckhoff Embedded PC		
PLC I/F	Ethernet		
Port no.	48898		
ADS port	801	801, 811, 821, 831	
PLC sta. no.	1		

PLC Setting:

For Twincat:

- a. Confirm PC IP address

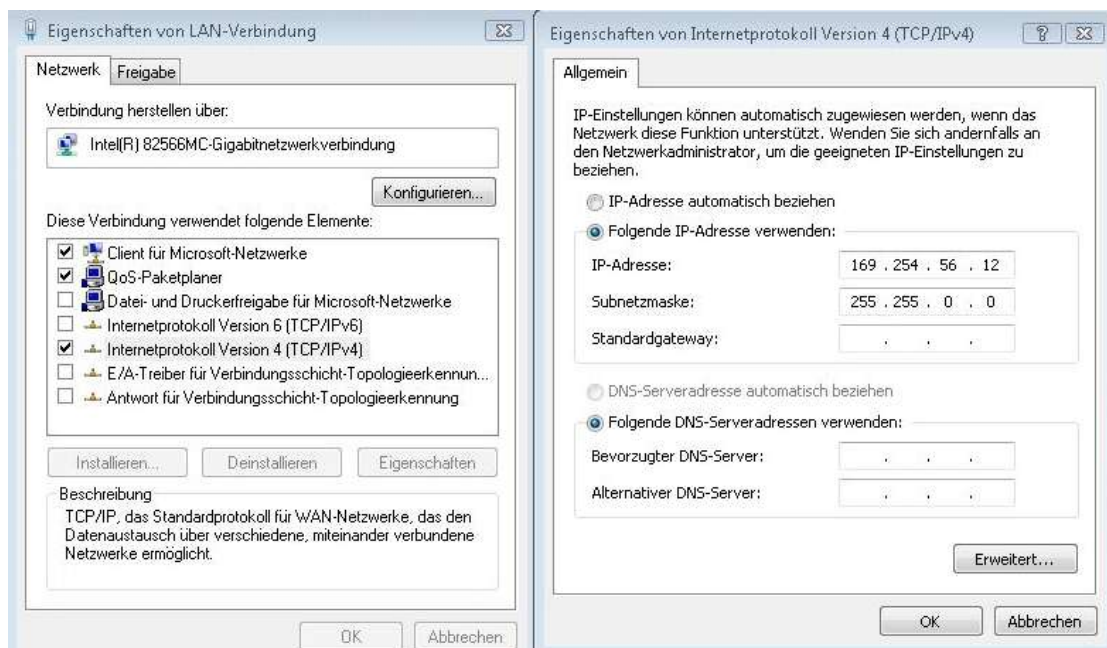

b. Open Twincat, Set IP address 169.254.56.12.1.1

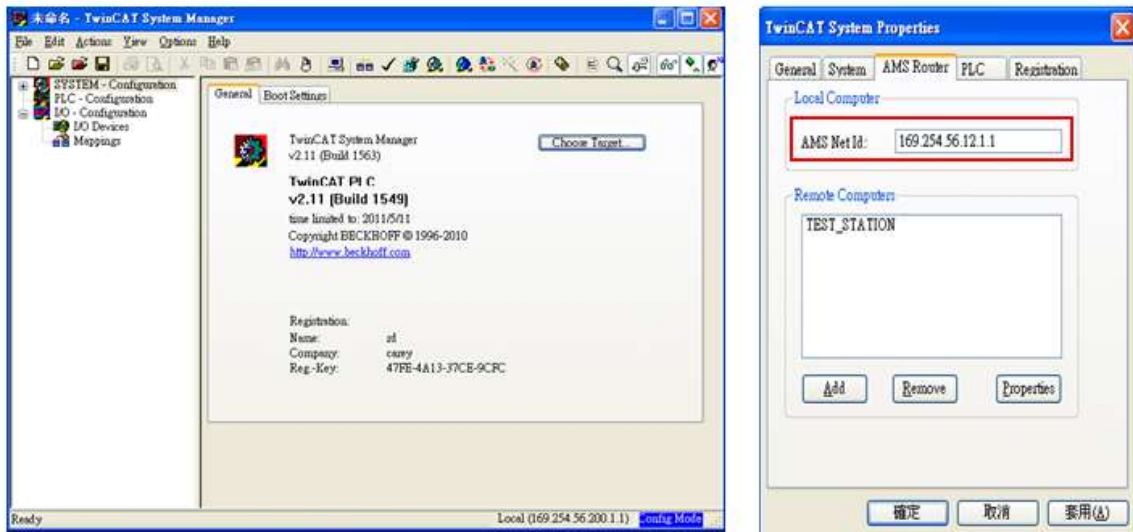

c. Use Twincat to build a Route Table to make sure the system is connected, if PLC power turns OFF and then ON, please redo this step.

Note: when connected, if “X” is displayed, the connection succeeded.

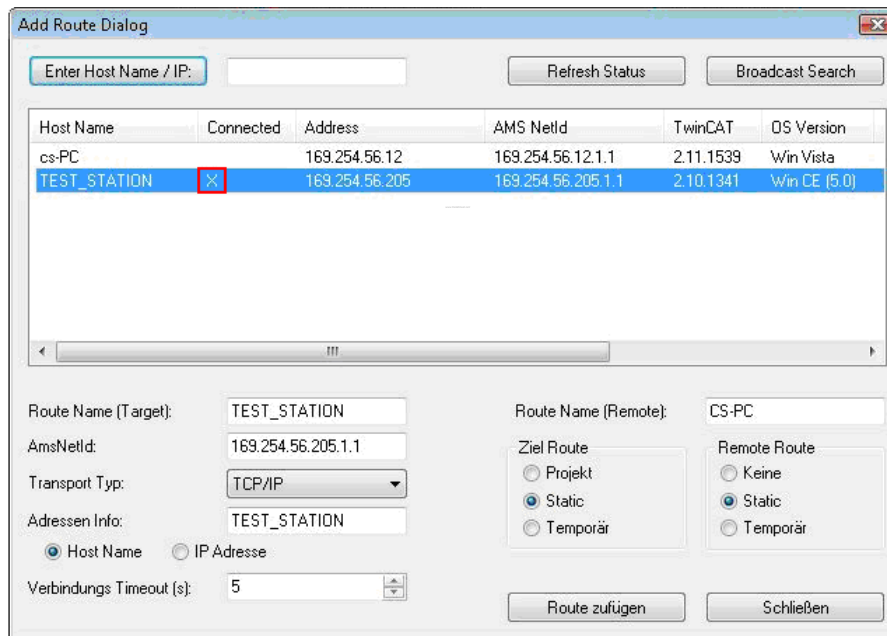

d. Open EasyBuilder, set IP address, ADS port and Port no.

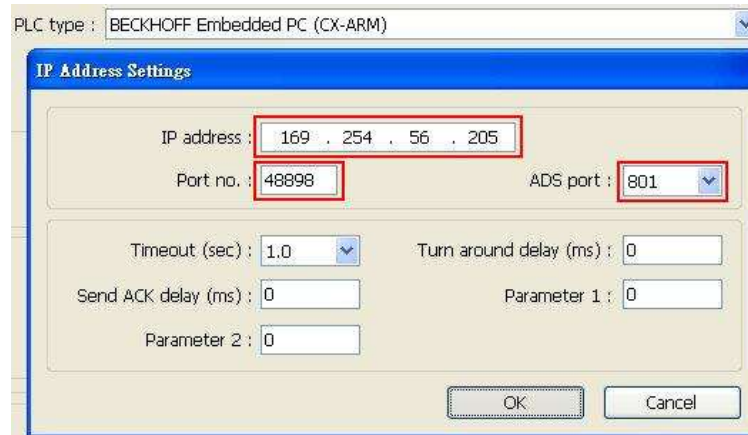

e. Run on line simulation.

Note: If the project is downloaded to HMI, please set HMI IP 169.254.56.12 identically to Twincat IP address setting.

For CERHOST:

a. Execute CERHOST.exe to connect with PLC on PC.



b. Enter PLC IP and Password (default password: 1).

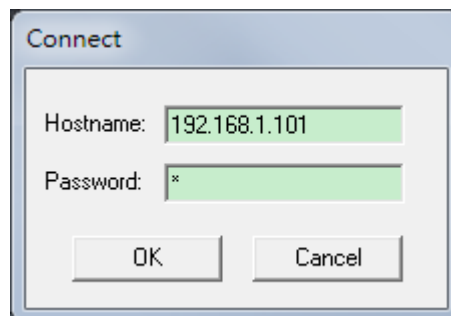

c. Succeeded to connect with PLC, click Start -> click Control Panel.

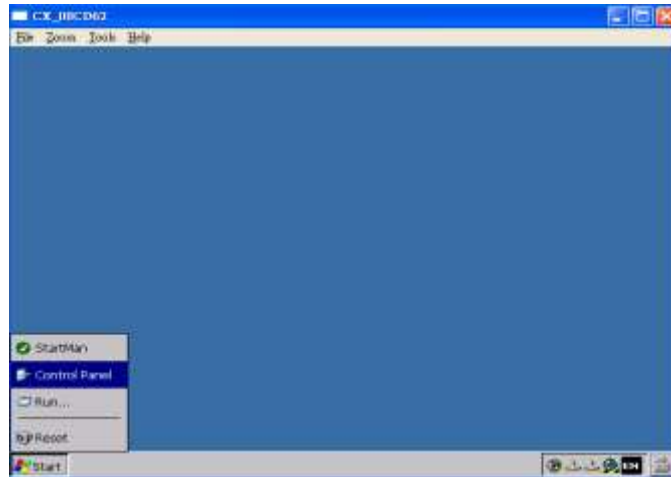

d. Click [Network and Dial-Up Connections] to display PLC device information; select the PLC to check its IP.

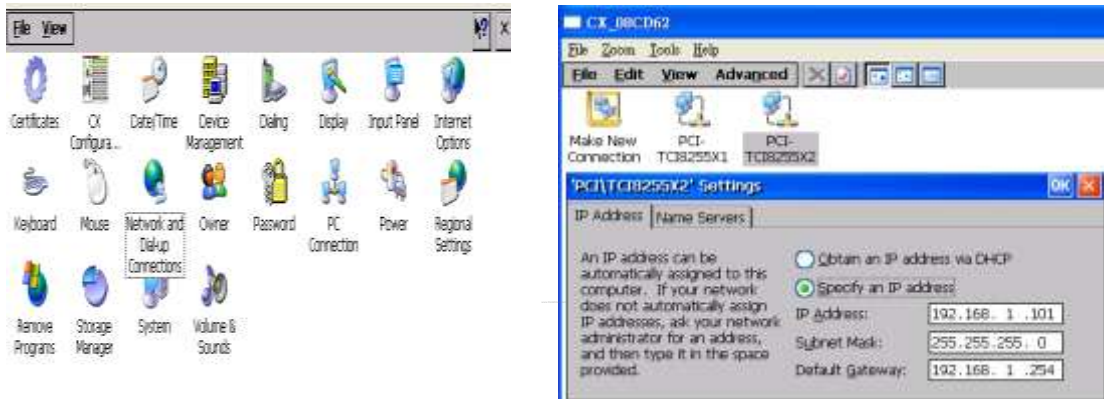

e. Access PLC system settings, the default directory: \Hard Disk\System, execute [TcAmsRemoteMgr].

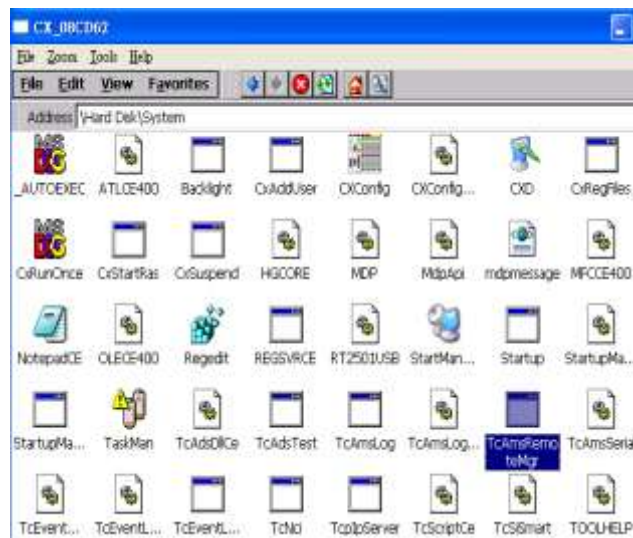

f. AMS Net Id consists of 6 numbers, separated by “.”. The first 4 numbers stand for IP and followed by “1.1”. The figure below shows the AMS Net Id of Local Computer, please enter PLC IP plus “1.1”. Remote Computers shows the information of the HMI to connect with. Click [Add] to add the HMI and click [OK] to finish setting.

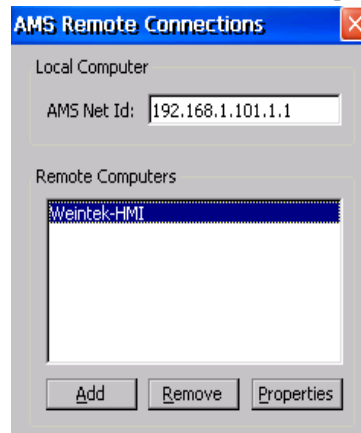

g. Name: Device name.

AMS Net Id: The IP followed by “1.1” of the device to connect with.

Address: The IP address of the device to connect with.

Transport: The way of connection.

Slow Connection: As shown in the figure below.

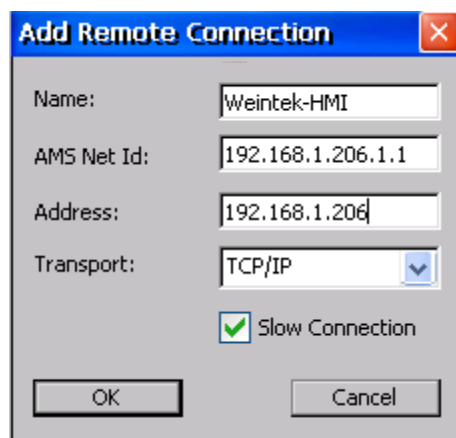

h. Return to Control Panel; execute CX Configuration Tool to confirm PLC AMS Net Id.

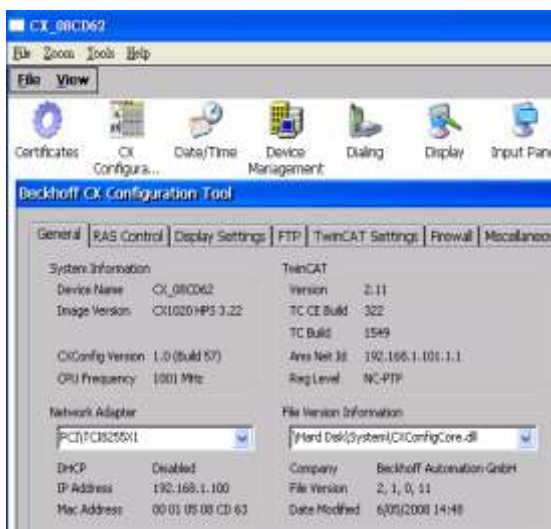

i. Confirm settings and click Start -> Reset PLC.

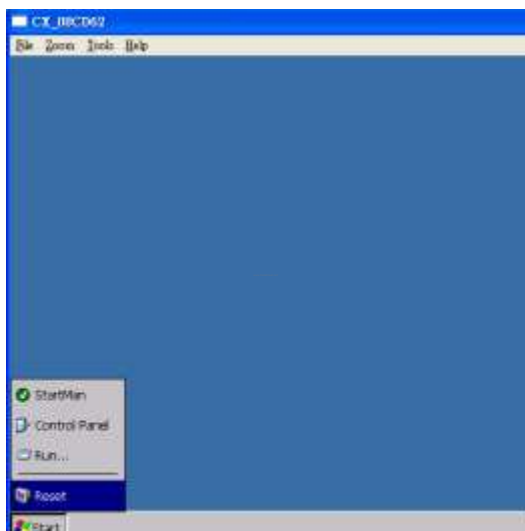

Device address:

Bit/Word	Device type	Format	Range	Memo
B	IX	DDDDDo	0 ~ 655357	o : Bit no.(0 ~ 7)
B	QX	DDDDDo	0 ~ 655357	o : Bit no.(0 ~ 7)
B	MX	DDDDDo	0 ~ 655357	o : Bit no.(0 ~ 7)
W	IW	DDDDD	0 ~ 65535	
W	QW	DDDDD	0 ~ 65535	
W	MW	DDDDD	0 ~ 65535	
DW	ID	DDDDD	0 ~ 65535	
DW	QD	DDDDD	0 ~ 65535	
DW	MD	DDDDD	0 ~ 65535	

Wiring Diagram:

Direct connect (crossover cable):

HMI RJ45 Male	Wire Color	Wire Color	PLC RJ45 Male
1 TX+	White/Orange	White/Green	3 RX+
2 TX-	Orange	Green	6 RX-
3 RX+	White/Green	White/Orange	1 TX+
4 BD4+	Blue	Blue	4 BD4+
5 BD4-	White/Blue	White/Blue	5 BD4-
6 RX-	Green	Orange	2 TX-
7 BD3+	White/Brown	White/Brown	7 BD3+
8 BD3-	Brown	Brown	8 BD3-



Through a hub:

HMI RJ45 Male	Wire Color	Wire Color	PLC RJ45 Male
1 TX+	White/Orange	White/Orange	1 TX+
2 TX-	Orange	Orange	2 TX-
3 RX+	White/Green	White/Green	3 RX+
4 BD4+	Blue	Blue	4 BD4+
5 BD4-	White/Blue	White/Blue	5 BD4-
6 RX-	Green	Green	6 RX-
7 BD3+	White/Brown	White/Brown	7 BD3+
8 BD3-	Brown	Brown	8 BD3-



Driver Version:

Version	Date	Description
V1.00	Apr/18/2011	Driver released.
V1.10	Aug/24/2011	Extended address range up to 65535.

CANopen Slave (for eMT3000 only)

eMT3000 series only

HMI Setting:

Parameters	Recommended	Options	Notes
PLC type	CAN (Controller Area Network) Bus		
Node ID	1	1~127	
Baud rate	250K	10K~1M	

Follow the steps to import EDS file.

Step 1. Object Dictionary Settings -> Setting

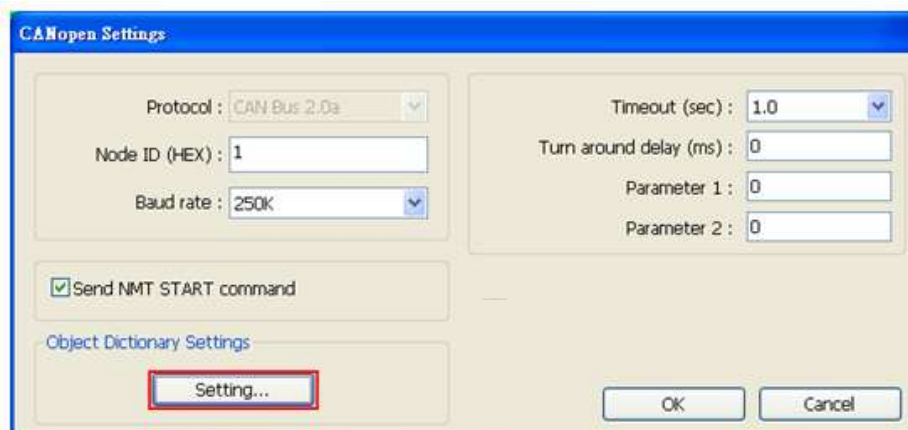

Step 2. Import EDS file.

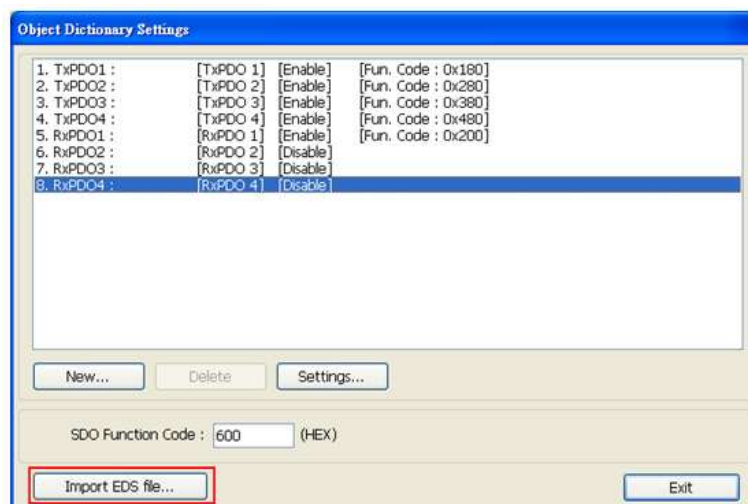

Step 3. Select the EDS file to be imported.

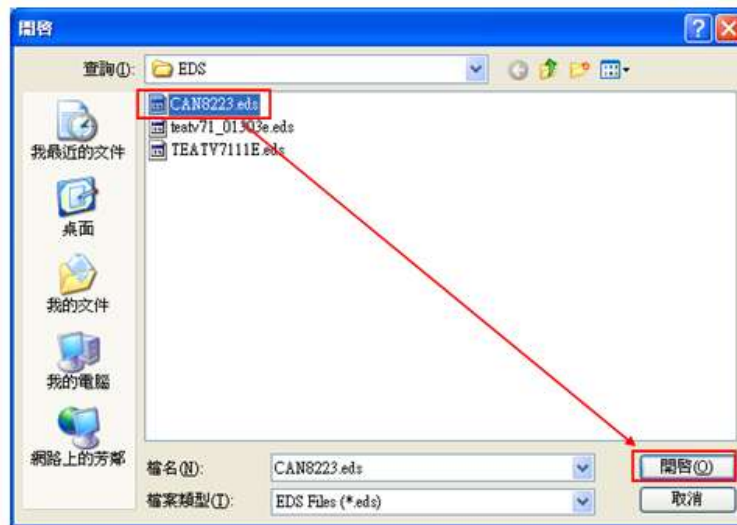

Step 4. Successfully import EDS file.



Device Address:



Bit/Word	Device type	Format	Range	Memo
B	TxPDOOn_BIT	DDDDNo	100 ~ 99977	DDD : PDO no. N : address (unit : byte). o : bit no.
B	RxPDOOn_BIT	DDDDNo	100 ~ 99977	DDD : PDO no. N : address (unit : byte). o : bit no.
B	SDO_8bit_Bit	HHHHHHo	0 ~ FFFFFFF7	HHHH(Index)+HH(Sub-index)+o(Bit no)
B	SDO_16bit_Bit	HHHHHHdd	0 ~ HHHHHH15	HHHH(Index)+HH(Sub-index)+dd(Bit no)
W	TxPDOOn	DDDN	10 ~ 9997	DDD : PDO no. N : address(unit : byte)

Bit/Word	Device type	Format	Range	Memo
W	TxPDOOn_Byte	DDDN	10 ~ 9997	DDD : PDO no. N : address(unit : byte)
W	RxPDOOn	DDDN	10 ~ 9997	DDD : PDO no. N : address(unit : byte)
W	RxPDOOn_Byte	DDDN	10 ~ 9997	DDD : PDO no. N : address(unit : byte)
W	SDO_8bit	HHHHHH	0~FFFFFF	HHHH(Index)+HH(Sub-index)
W	SDO_16bit	HHHHHH	0~FFFFFF	
W	SDO_32bit	HHHHHH	0~FFFFFF	

Wiring Diagram:

The following represents the view of HMI & PLC.

eMT3000 series

CAN Bus 9P D-Sub Female			CAN Device
7 D-			D-
8 D+			D+
5 GND			GND
			

Demo Project Link:



Driver Version:

Version	Date	Description
V1.40	Aug/20/2012	Add device type : SDO_8bit_Bit , SDO_16bit_Bit.

Change

Supported Series: Compressor controller

Website: <http://www.sh-changjia.com/>

HMI Setting:

Parameters	Recommended	Options	Notes
PLC type	Change		
PLC I/F	RS485 2W		
Baud rate	9600		
Data bits	8		
Parity	None		
Stop bits	1		
PLC sta. no.	1	1~6	



Device Address:

Bit/Word	Device type	Format	Range	Memo
B	CTL	DDD	0 ~ 5, 128, 150	Write only
DW	SET	DDD	0 ~ 57, 128	
DW	STATUS	DD	1 ~ 20	Read only



Wiring Diagram:

The following represents the view of HMI & PLC.



eMT3000 series

COM1 RS485 2W 9P D-Sub Male	COM3 RS485 2W 9P D-Sub Male		Change RS485 terminal
1 RX-	6 Data-		15 D-
2 RX+	9 Data+		16 D+
5 GND	5 GND		
			

MT6000/8000 series except MT6050i/MT8050i

COM1 RS485 2W 9P D-Sub Male	COM3 RS485 2W 9P D-Sub Male		Change RS485 terminal
1 RX-	6 Data-		15 D-
2 RX+	9 Data+		16 D+
5 GND	5 GND		
			

MT6050i/MT8050i

COM1 RS485 2W 9P D-Sub Female	COM3 RS485 2W 9P D-Sub Female		Change RS485 terminal
1 RX-	7 Data-		15 D-
2 RX+	8 Data+		16 D+
5 GND	5 GND		
			

Driver Version:

Version	Date	Description
V1.00	Jan/19/2011	Driver released.

Cimon CM1-CP4A/ECO1A

Supported Series: Cimon CM1 series, CP4A module

Website: <http://www.kdtsys.com>

HMI Setting:

Parameters	Recommended	Options	Notes
PLC type	Cimon CM1-CP4A/ECO1A		
PLC I/F	RS232		
Baud rate	38400		
Data bits	8		
Parity	None		
Stop bits	1		
PLC sta. no.	1		



Device Address:

Bit/Word	Device type	Format	Range	Memo
B	X	DDh	0 ~ 23f	0-1F Read Only
B	Y	DDh	0 ~ 23f	
B	M	DDDh	0 ~ 511f	
B	K	DDDh	0 ~ 127f	
B	L	DDDh	0 ~ 127f	
B	F	DDDh	0 ~ 127f	Read Only
B	T	DDDh	0 ~ 102f	
B	C	DDDh	0 ~ 102f	
W	D	DDDD	0 ~ 4999	
W	S	DD	0 ~ 99	Max. Range: 99
W	TS	DDDD	0 ~ 1023	
W	TC	DDDD	0 ~ 1023	
W	CS	DDDD	0 ~ 1023	
W	CC	DDDD	0 ~ 1023	





Wiring Diagram:

The following represents the view of HMI & PLC.



eMT3000 series

COM1 RS232 9P D-Sub Female	COM3 RS232 9P D-Sub Female		CM1-CP4A RS232 6P RJ11 Male
2 RX	8 RX		2 TXD
3 TX	7 TX		3 RXD
5 GND	5 GND		5 GND
			

MT6000/8000 series except MT6050i/MT8050i

COM1 RS232 9P D-Sub Female	COM2 RS232 9P D-Sub Female	COM3 RS232 9P D-Sub Male	CM1-CP4A RS232 6P RJ11 Male
2 RX	6 RX	8 RX	2 TXD
3 TX	4 TX	7 TX	3 RXD
5 GND	5 GND	5 GND	5 GND
			

MT6050i/MT8050i

COM1 RS232 9P D-Sub Female			CM1-CP4A RS232 6P RJ11 Male
9 RX			2 TXD
6 TX			3 RXD
5 GND			5 GND
			

Driver Version:

Version	Date	Description
V1.20	Nov/30/2009	

Cimon CM1-SC02A

Supported Series: Cimon CM series, SC02A module

Website: <http://www.kdtsys.com>

HMI Setting:

Parameters	Recommended	Options	Notes
PLC type	Cimon CM1-SC02A		
PLC I/F	RS232		
Baud rate	38400		
Data bits	8		
Parity	None		
Stop bits	1		
PLC sta. no.	1		



Device Address:

Bit/Word	Device type	Format	Range	Memo
B	X	DDh	0 ~ 23f	0-1F Read Only
B	Y	DDh	0 ~ 23f	0-F Read Only
B	M	DDDh	0 ~ 511f	
B	K	DDDh	0 ~ 127f	
B	L	DDDh	0 ~ 127f	
B	F	DDDh	0 ~ 127f	Read Only
B	T	DDDh	0 ~ 102f	
B	C	DDDh	0 ~ 102f	
W	D	DDDD	0 ~ 4999	
W	S	DD	0 ~ 99	Max. Range: 99
W	TS	DDDD	0 ~ 1023	
W	TC	DDDD	0 ~ 1023	
W	CS	DDDD	0 ~ 1023	
W	CC	DDDD	0 ~ 1023	





Wiring Diagram:

The following represents the view of HMI & PLC.



eMT3000 series

COM1 RS232 9P D-Sub Female	COM3 RS232 9P D-Sub Female		CM1-SC02A RS232 9P D-Sub Male
2 RX	8 RX		3 TD
3 TX	7 TX		2 RD
5 GND	5 GND		5 GND
			

MT6000/8000 series except MT6050i/MT8050i

COM1 RS232 9P D-Sub Female	COM2 RS232 9P D-Sub Female	COM3 RS232 9P D-Sub Male	CM1-SC02A RS232 9P D-Sub Male
2 RX	6 RX	8 RX	3 TD
3 TX	4 TX	7 TX	2 RD
5 GND	5 GND	5 GND	5 GND
			

MT6050i/MT8050i

COM1 RS232 9P D-Sub Female			CM1-SC02A RS232 9P D-Sub Male
9 RX			3 TD
6 TX			2 RD
5 GND			5 GND
			

Driver Version:

Version	Date	Description
V1.20	Nov/30/2009	

Copley Controls

Supported Series: Digital Servo Driver & Controllers, Xenus, Xenus Micro, Accelnet, Accelnet Micro, Stepnet series.

Website: <http://www.copleycontrols.com/motion/>

HMI Setting:

Parameters	Recommended	Options	Notes
PLC type	Copley Controls		
PLC I/F	RS232		
Baud rate	9600	9600~115200	
Data bits	8	8	
Parity	None	Even, Odd, None	
Stop bits	1	1	
HMI sta. no.	0		
PLC sta. no.	0	0-127	



Device Address:

Bit/Word	Device type	Format	Range	Memo
W	Flash INT 16	HHH	0 ~ 999	For Register is INT16 or U16
W	RAM INT 16	HHH	0 ~ 999	For Register is INT16 or U16
W	Flash INT 32	HHH	0 ~ 999	For Register is INT32 or U32
W	RAM INT 32	HHH	0 ~ 999	For Register is INT32 or U32
W	Register	DDDD	0 ~ 2457	
W	T_command	H	0	
W	Reset	H	0	





Wiring Diagram:

The following represents the view of HMI & PLC.



9P D-Sub to 6P RJ11: Xenus, Xenus Micro, Accelnet, Stepnet
eMT3000 series

COM1 RS232 9P D-Sub Female	COM3 RS232 9P D-Sub Female		RS232 6P RJ11 Male
2 RX	8 RX		5 TXD
3 TX	7 TX		2 RXD
5 GND	5 GND		3, 4 GND
			

MT6000/8000 series except MT6050i/MT8050i

COM1 RS232 9P D-Sub Female	COM2 RS232 9P D-Sub Female	COM3 RS232 9P D-Sub Male	RS232 6P RJ11 Male
2 RX	6 RX	8 RX	5 TXD
3 TX	4 TX	7 TX	2 RXD
5 GND	5 GND	5 GND	3, 4 GND
			



MT6050i/MT8050i

COM1 RS232 9P D-Sub Female			RS232 6P RJ11 Male
9 RX			5 TXD
6 TX			2 RXD
5 GND			3, 4 GND
			



The following represents the view of HMI & PLC.

Accelnet Micro:

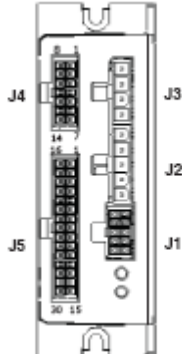
eMT3000 series

COM1 RS232 9P D-Sub Female	COM3 RS232 9P D-Sub Female		Accelnet Micro Panel RS232 J5 Cable Connector
2 RX	8 RX		29 TXD
3 TX	7 TX		14 RXD
5 GND	5 GND		15 GND
			

MT6000/8000 series except MT6050i/MT8050i

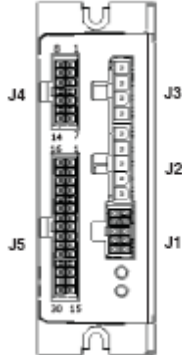
COM1 RS232 9P D-Sub Female	COM2 RS232 9P D-Sub Female	COM3 RS232 9P D-Sub Male	Accelnet Micro Panel RS232 J5 Cable Connector
2 RX	6 RX	8 RX	29 TXD
3 TX	4 TX	7 TX	14 RXD
5 GND	5 GND	5 GND	15 GND
			

MT6050i/MT8050i

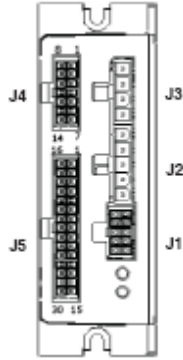
COM1 RS232 9P D-Sub Female			Accelnet Micro Panel RS232 J5 Cable Connector
9 RX			29 TXD
6 TX			14 RXD
5 GND			15 GND
			

Driver Version:

Version	Date	Description
V1.20	Dec/30/2008	

CROUZET M3 (FBD)

HMI Setting:

Parameters	Recommended	Options	Notes
PLC type	CROUZET M3 (FBD)		
PLC I/F	RS232		
Baud rate	115200		
Data bits	7		
Parity	Even		
Stop bits	1		
PLC sta. no.	1		

Device Address:

Bit/Word	Device type	Format	Range	Memo
B	SLI_Bit	DDh	10 ~ 24f	Serial link input
B	SLO_Bit	DDh	250 ~ 48f	Serial link output (read only)
B	State	D	1 —	State in PLC (read only)
W	IA	DD	1 ~ 99	Analogy input (default: 1 ~ 4)
W	SL_IN	DD	1 ~ 24	Serial link input
W	SL_OUT	DD	25 ~ 48	Serial link output (read only)
W	Time	D	1 ~ 6	Time & Day*
W	Order	D	1	Command** (write only)



* : address 1: second, address 2 : minute, address 3 : hour , address 4 : day, address 5 : month, address 6 : year. The value range for “Year” is 0~99, entering “0” represents year 2000, entering “99” represents year 2099.

** : run mode write 2, stop mode write 1.



Wiring Diagram:

The following represents the view of HMI & PLC.

eMT3000 series

COM1 RS232 9P D-Sub Female			CROUZET M3 RS232 9P D-Sub Male (Extension Cable)
2 RX			2 TD
3 TX			3 RD
5 GND			5 GND
7 RTS			4 DTR
			

MT6000/8000 series except MT6050i/MT8050i

COM1 RS232 9P D-Sub Female			CROUZET M3 RS232 9P D-Sub Male (Extension Cable)
2 RX			2 TD
3 TX			3 RD
5 GND			5 GND
7 RTS			4 DTR
			



(3m serial link cable)

Note: Please use 3m serial link cable (Accessories from Millenium 3) and extension cable (as shown) to communicate with HMI series.

MT6050/8050i
RS232
9P D-SUB Male
COM1

CROUZET CD12
RS-232
9P D-SUB Female
(Extension cable)

6	TX	3	RD
9	RX	2	TD
5	GND	5	GND
4	TX+	4	DTR



HMI

+



User's cable

+



88970102

+



Millenium 3

Driver Version:

Version	Date	Description
V1.10	Oct/26/2010	—
V1.20	Mar/29/2012	Add device type : State, Time, Order
V1.30	May/14/2012	“Time” entering is now allowed.

CROUZET M3 (LAD)

HMI Setting:

Parameters	Recommended	Options	Notes
PLC type	CROUZET M3 (LAD)		
PLC I/F	RS232		
Baud rate	115200		
Data bits	7		
Parity	Even		
Stop bits	1		
PLC sta. no.	1		

Device Address:

Bit/Word	Device type	Format	Range	Memo
B	I	DD	1 ~ 99	Input (default: 1 ~ 4)
B	O	DD	1 ~ 99	Output (default: 1 ~ 4)
B	M	DD	1 ~ 28	Relay
B	SLI_Bit	DDh	10 ~ 24f	Serial link input
B	SLO_Bit	DDh	250 ~ 48f	Serial link output (read only)
B	State	D	1	State in PLC (read only)
W	T	DD	1 ~ 12	Timer
W	C	DD	1 ~ 16	Counter
W	IA	DD	1 ~ 99	Analogy input (default: 1 ~ 4)
W	SL_IN	DD	1 ~ 24	Serial link input
W	SL_OUT	DD	25 ~ 48	Serial link output (read only)
W	Time	D	1 ~ 6	Time & Day *
W	Order	D	1	Command (write only) **



* : address 1: second, address 2 : minute, address 3 : hour , address 4 : day, address 5 : month, address 6 : year .The value range for “Year” is 0~99, entering “0” represents year 2000, entering “99” represents year 2099.

** : run mode write 2, stop mode write 1.



Wiring Diagram:

The following represents the view of HMI & PLC.

eMT3000 series

COM1 RS232 9P D-Sub Female			CROUZET M3 RS232 9P D-Sub Male (Extension Cable)
2 RX			2 TD
3 TX			3 RD
5 GND			5 GND
7 RTS			4 DTR
			

MT6000/8000 series except MT6050i/MT8050i

COM1 RS232 9P D-Sub Female			CROUZET M3 RS232 9P D-Sub Male (Extension Cable)
2 RX			2 TD
3 TX			3 RD
5 GND			5 GND
7 RTS			4 DTR
			



(3m serial link cable)

Note: Please use 3m serial link cable (Accessories from Millenium 3) and extension cable (as shown) to communicate with HMI series.

MT6050/8050i
RS232
9P D-SUB Male
COM1

CROUZET CD12
RS-232
9P D-SUB Female
(Extension cable)

6	TX		3	RD
9	RX		2	TD
5	GND		5	GND
4	TX+		4	DTR



HMI



User's cable



88970102



Millenium 3

Driver Version:

Version	Date	Description
V1.20	Oct/26/2010	
V1.30	Mar/30/2012	Add device type : State, Time, Order
V1.40	May/14/2012	"Time" entering is now allowed.

Danfoss ECL Apex20

Website: <http://www.danfoss.com/>

HMI Setting:

Parameters	Recommended	Options	Notes
PLC type	Danfoss ECL Apex20		
PLC I/F	RS232		
Baud rate	9600		
Data bits	8		
Parity	None		
Stop bits	1		
PLC sta. no.	1		

Device Address:



Bit/Word	Device type	Format	Range	Memo
B	Flag	DDDD	0 ~ 8191	
B	Output	DDDD	0 ~ 1023	
B	Input	DDDD	0 ~ 1023	
B	Reg_Bit	DDDDdd	0 ~ 1638331	dd: Bit no. (00 ~ 31)
DW	Register	DDDDD	0 ~ 16383	
DW	Counter	DDDD	0 ~ 1599	
DW	Timer	DDDD	0 ~ 1599	
DW	Reg_Float	DDDDD	0 ~ 16383	Support 32-bit float format

EasyBuilder device address range may differ from PLC extended mode, please refer to EasyBuilder address range as above.





Wiring Diagram:

The following represents the view of HMI & PLC.



eMT3000 series

COM1 RS232 9P D-Sub Female	COM3 RS232 9P D-Sub Female		ECL Apex20 Controller RS232 9P D-Sub Male
2 RX	8 RX		3 TXD
3 TX	7 TX		2 RXD
5 GND	5 GND		5 GND
			7 RTS
			8 CTS
			circuit
			

MT6000/8000 series except MT6050i/MT8050i



COM1 RS232 9P D-Sub Female	COM2 RS232 9P D-Sub Female	COM3 RS232 9P D-Sub Male	ECL Apex20 Controller RS232 9P D-Sub Male
2 RX	6 RX	8 RX	3 TXD
3 TX	4 TX	7 TX	2 RXD
5 GND	5 GND	5 GND	5 GND
			7 RTS
			8 CTS
			circuit
			

MT6050i/MT8050i



COM1 RS232 9P D-Sub Female			ECL Apex20 Controller RS232 9P D-Sub Male
9 RX			3 TXD
6 TX			2 RXD
5 GND			5 GND
			7 RTS
			8 CTS
			circuit
			

The following represents the view of HMI & PLC.



eMT3000 series

COM1 RS485 2W 9P D-Sub Male	COM3 RS485 2W 9P D-Sub Male		ECL Apex20 Controller Port#1 / Port#0
1 RX-	6 Data-		11 / 29
2 RX+	9 Data+		12 / 28
5 GND	5 GND		
			

MT6000/8000 series except MT6050i/MT8050i

COM1 RS485 2W 9P D-Sub Male	COM3 RS485 2W 9P D-Sub Male		ECL Apex20 Controller Port#1 / Port#0
1 RX-	6 Data-		11 / 29
2 RX+	9 Data+		12 / 28
5 GND	5 GND		
			

MT6050i/MT8050i

COM1 RS485 2W 9P D-Sub Female	COM3 RS485 2W 9P D-Sub Female		ECL Apex20 Controller Port#1 / Port#0
1 RX-	7 Data-		11 / 29
2 RX+	8 Data+		12 / 28
5 GND	5 GND		
			

Driver Version:

Version	Date	Description
V1.40	OCT/06/2008	

Danfoss ECL Apex20 (Ethernet)

Website: <http://www.danfoss.com/>

HMI Setting:

Parameters	Recommended	Options	Notes
PLC type	Danfoss ECL Apex20 (Ethernet)		
PLC I/F	Ethernet		
Port no.	5050		
PLC sta. no.	0		

Device Address:

Bit/Word	Device type	Format	Range	Memo
B	Flag	DDDD	0 ~ 8191	
B	Output	DDDD	0 ~ 1023	
B	Input	DDDD	0 ~ 1023	
B	Reg_Bit	DDDDdd	0 ~ 1638331	dd: Bit no. (00 ~ 31)
W	Register	DDDD	0 ~ 16383	
W	Counter	DDDD	0 ~ 1599	
W	Timer	DDDD	0 ~ 1599	
W	Reg_Float	DDDD	0 ~ 16383	Support 32-bit float format

EasyBuilder device address range may differ from PLC extended mode, please refer to EasyBuilder address range as above.

Wiring Diagram:

Direct connect (crossover cable):

HMI RJ45 Male	Wire Color	Wire Color	PLC RJ45 Male
1 TX+	White/Orange	White/Green	3 RX+
2 TX-	Orange	Green	6 RX-
3 RX+	White/Green	White/Orange	1 TX+
4 BD4+	Blue	Blue	4 BD4+
5 BD4-	White/Blue	White/Blue	5 BD4-
6 RX-	Green	Orange	2 TX-
7 BD3+	White/Brown	White/Brown	7 BD3+
8 BD3-	Brown	Brown	8 BD3-



Through a hub:

HMI RJ45 Male	Wire Color	Wire Color	PLC RJ45 Male
1 TX+	White/Orange	White/Orange	1 TX+
2 TX-	Orange	Orange	2 TX-
3 RX+	White/Green	White/Green	3 RX+
4 BD4+	Blue	Blue	4 BD4+
5 BD4-	White/Blue	White/Blue	5 BD4-
6 RX-	Green	Green	6 RX-
7 BD3+	White/Brown	White/Brown	7 BD3+
8 BD3-	Brown	Brown	8 BD3-



Driver Version:

Version	Date	Description
V1.10	Jan/10/2011	

Danfoss FC Series

Supported Series: FC051, FC100, FC200, FC300, VLT Micro Driver.

Website: <http://www.danfoss.com/>

HMI Setting:

Parameters	Recommended	Options	Notes
PLC type	Danfoss FC Series		
PLC I/F	RS485 2W		
Baud rate	9600		
Data bits	8		
Parity	Even		
Stop bits	1		
PLC sta. no.	1		

Device Address:



Bit/Word	Device type		Format	Range	Memo
W	Parameter	09	DDDD	0 ~ 9999	Set Parameter
DW	Reference	10	D	0 ~ 1	Control Bus Reference
DW	Para_Index	11	DDDDDD	0 ~ 999999	Set Parameter(Index)

Para_Index 310.1=31001, Para_Index310.0=31000



Wiring Diagram:

The following represents the view of HMI & PLC.



eMT3000 series

COM1 RS485 2W 9P D-Sub Male	COM3 RS485 2W 9P D-Sub Male		FC RS485 terminal
1 RX-	6 Data-		69 D-
2 RX+	9 Data+		68 D+
5 GND	5 GND		
			

MT6000/8000 series except MT6050i/MT8050i

COM1 RS485 2W 9P D-Sub Male	COM3 RS485 2W 9P D-Sub Male		FC RS485 terminal
1 RX-	6 Data-		69 D-
2 RX+	9 Data+		68 D+
5 GND	5 GND		
			

MT6050i/MT8050i

COM1 RS485 2W 9P D-Sub Female	COM3 RS485 2W 9P D-Sub Female		FC RS485 terminal
1 RX-	7 Data-		69 D-
2 RX+	8 Data+		68 D+
5 GND	5 GND		
			

*RW100 set PCD1 Control Word of station 1

*RW101 read PCD1 Status Word of station 1

*RW102 set PCD2 Control Word of station 2

*RW103 read PCD2 Status Word of station 2

*RW104 set PCD3 Control Word of station 3

*RW105 read PCD3 Status Word of station 3

*RW106 set PCD4 Control Word of station 4

*RW107 read PCD4 Status Word of station 4

Driver Version:

Version	Date	Description
V1.10	Jan/14/2010	

Danfoss VLT2800 Series

Supported Series: VLT2800 series

Website: <http://www.danfoss.com/>

HMI Setting:

Parameters	Recommended	Options	Notes
PLC type	Danfoss VLT2800 Series		
PLC I/F	RS485 2W		
Baud rate	9600		
Data bits	8		
Parity	Even		
Stop bits	1		
PLC sta. no.	1	0-126	According to PLC

PLC Setting:

Communication mode	9600, Even, 8, 1 (default)
--------------------	----------------------------

Device Address:

Bit/Word	Device type	Format	Range	Memo
DW	Parameter	DDDD	0 ~ 2000	Set Parameter
W	Reference	D	0 ~ 1	Control Bus Reference



The control word register is set according to the station number.

If the station number is 1, the control word will be RW100 and RW101; if the station number is 2, the control word will be RW102 and RW103, and so on.



Wiring Diagram:

The following represents the view of HMI & PLC.



eMT3000 series

COM1 RS485 2W 9P D-Sub Male	COM3 RS485 2W 9P D-Sub Male		RS485 terminal
1 RX-	6 Data-		69 D-
2 RX+	9 Data+		68 D+
5 GND	5 GND		
			

MT6000/8000 series except MT6050i/MT8050i

COM1 RS485 2W 9P D-Sub Male	COM3 RS485 2W 9P D-Sub Male		RS485 terminal
1 RX-	6 Data-		69 D-
2 RX+	9 Data+		68 D+
5 GND	5 GND		
			

MT6050i/MT8050i

COM1 RS485 2W 9P D-Sub Female	COM3 RS485 2W 9P D-Sub Female		RS485 terminal
1 RX-	7 Data-		69 D-
2 RX+	8 Data+		68 D+
5 GND	5 GND		
			

Driver Version:

Version	Date	Description
V1.10	Dec/30/2008	

DELTA DVP

Supported Series: DELTA DVP series

Website: <http://www.deltadriver.com>

HMI Setting:

Parameters	Recommended	Options	Notes
PLC type	DELTA DVP		
PLC I/F	RS232	RS232, RS485	
Baud rate	9600	9600, 19200	
Data bits	7	7, 8	
Parity	Even	Even, Odd, None	
Stop bits	1	1	
PLC sta. no.	1	0-255	



Device Address:

Bit/Word	Device type	Format	Range	Memo
B	X	OOOOO	0 ~ 23417 (octal)	Input
B	Y	OOOOO	0 ~ 23417 (octal)	Output
B	M	DDDDD	0 ~ 65536	Auxiliary Relay
B	S	DDDD	0 ~ 9999	Step Relay
B	T	DDDD	0 ~ 9999	Timer
B	C	DDDD	0 ~ 9999	Counter
B	TV_Bit	DDDDdd	0 ~ 999915	Timer
W	TV	DDDD	0 ~ 9999	Timer
W	CV	DDD	0 ~ 127	Counter
W	CV2	DDD	200 ~ 254	Double Word Counter
W	D	DDDD	0 ~ 9999	Data Register





Wiring Diagram:

The following represents the view of HMI & PLC.



eMT3000 series

COM1 RS232 9P D-Sub Female	COM3 RS232 9P D-Sub Female		RS232 8P Mini-DIN Male
2 RX	8 RX		5 TXD
3 TX	7 TX		4 RXD
5 GND	5 GND		3/8 GND
			

MT6000/8000 series except MT6050i/MT8050i

COM1 RS232 9P D-Sub Female	COM2 RS232 9P D-Sub Female	COM3 RS232 9P D-Sub Male	RS232 8P Mini-DIN Male
2 RX	6 RX	8 RX	5 TXD
3 TX	4 TX	7 TX	4 RXD
5 GND	5 GND	5 GND	3/8 GND
			

MT6050i/MT8050i

COM1 RS232 9P D-Sub Female			RS232 8P Mini-DIN Male
9 RX			5 TXD
6 TX			4 RXD
5 GND			3/8 GND
			

Driver Version:

Version	Date	Description
V1.20	Dec/30/2008	

DELTA DVPEN01-SL (Ethernet)

Website: <http://www.deltadrivers.com>

HMI Setting:

Parameters	Recommended	Options	Notes
PLC type	DELTA DVPEN01-SL (Ethernet)		
PLC I/F	Ethernet		
Port no.	502		
PLC sta. no.	0		

Device Address:

Bit/Word	Device type	Format	Range	Memo
B	C_Bit	DDD	0 ~ 255	
B	M	DDDD	0 ~ 4095	
B	S	DDDD	0 ~ 1023	
B	T_Bit	DDD	0 ~ 255	
B	X	OOO	0 ~ 571	
B	Y	OOO	0 ~ 571	
W	C	DDD	0 ~ 199	
DW	C_32Bit	DDD	200 ~ 255	
W	D	DDDDD	0 ~ 11999	
W	T	DDD	0 ~ 255	

Wiring Diagram:

Direct connect (crossover cable):

HMI RJ45 Male	Wire Color	Wire Color	PLC RJ45 Male
1 TX+	White/Orange	White/Green	3 RX+
2 TX-	Orange	Green	6 RX-
3 RX+	White/Green	White/Orange	1 TX+
4 BD4+	Blue	Blue	4 BD4+
5 BD4-	White/Blue	White/Blue	5 BD4-
6 RX-	Green	Orange	2 TX-
7 BD3+	White/Brown	White/Brown	7 BD3+
8 BD3-	Brown	Brown	8 BD3-



Through a hub:

HMI RJ45 Male	Wire Color	Wire Color	PLC RJ45 Male
1 TX+	White/Orange	White/Orange	1 TX+
2 TX-	Orange	Orange	2 TX-
3 RX+	White/Green	White/Green	3 RX+
4 BD4+	Blue	Blue	4 BD4+
5 BD4-	White/Blue	White/Blue	5 BD4-
6 RX-	Green	Green	6 RX-
7 BD3+	White/Brown	White/Brown	7 BD3+
8 BD3-	Brown	Brown	8 BD3-



Driver Version:

Version	Date	Description
V1.00	Jun/11/2012	Driver released.
V1.10	Aug/20/2012	Add device type : C_32Bit.

DL/T645 CHUANG HONG

Website: <http://www.cw180.com>

HMI Setting:

Parameters	Recommended	Options	Notes
PLC type	DL/T645 CHUANG HONG		
PLC I/F	RS485 2W		
Baud rate	9600		
Data bits	8		
Parity	Even		
Stop bits	1		
PLC sta. no.	1		

Device Address:

Bit/Word	Device type	Format	Range	Memo
W	B621	D	0 ~ 1	
W	B622	D	0 ~ 1	
W	B623	D	0 ~ 1	
W	zero phase	D	0 ~ 1	
W	B611	D	0 ~ 1	
W	B612	D	0 ~ 1	
W	B613	D	0 ~ 1	
W	B631	D	0 ~ 1	
W	B632	D	0 ~ 1	
W	B633	D	0 ~ 1	
W	B630	D	0 ~ 1	
W	B641	D	0 ~ 1	
W	B642	D	0 ~ 1	
W	B643	D	0 ~ 1	
W	B640	D	0 ~ 1	
W	A-apparentT	D	0 ~ 1	
W	B-apparentT	D	0 ~ 1	
W	C-apparentT	D	0 ~ 1	
W	T-apparentT	D	0 ~ 1	
W	B650	D	0 ~ 1	

Bit/Word	Device type	Format	Range	Memo
W	B651	D	0 ~ 1	
W	B652	D	0 ~ 1	
W	B653	D	0 ~ 1	
W	9010	D	0 ~ 1	
W	9020	D	0 ~ 1	
W	9110	D	0 ~ 1	
W	9120	D	0 ~ 1	
W	9130	D	0 ~ 1	
W	9140	D	0 ~ 1	
W	9150	D	0 ~ 1	
W	9160	D	0 ~ 1	
W	9410	D	0 ~ 1	
W	9420	D	0 ~ 1	
W	9510	D	0 ~ 1	
W	9520	D	0 ~ 1	
W	9530	D	0 ~ 1	
W	9540	D	0 ~ 1	
W	9550	D	0 ~ 1	
W	9560	D	0 ~ 1	
W	9810	D	0 ~ 1	
W	9820	D	0 ~ 1	
W	9910	D	0 ~ 1	
W	9920	D	0 ~ 1	
W	9930	D	0 ~ 1	
W	9940	D	0 ~ 1	
W	9950	D	0 ~ 1	
W	9960	D	0 ~ 1	
W	A010	D	0 ~ 1	
W	A020	D	0 ~ 1	
W	A110	D	0 ~ 1	
W	A120	D	0 ~ 1	
W	A130	D	0 ~ 1	
W	A140	D	0 ~ 1	
W	A150	D	0 ~ 1	
W	A160	D	0 ~ 1	
W	A410	D	0 ~ 1	
W	A420	D	0 ~ 1	
W	A510	D	0 ~ 1	
W	A520	D	0 ~ 1	
W	A530	D	0 ~ 1	

Bit/Word	Device type	Format	Range	Memo
W	A540	D	0 ~ 1	
W	A550	D	0 ~ 1	
W	A560	D	0 ~ 1	
W	A810	D	0 ~ 1	
W	A820	D	0 ~ 1	
W	A910	D	0 ~ 1	
W	A920	D	0 ~ 1	
W	A930	D	0 ~ 1	
W	A940	D	0 ~ 1	
W	A950	D	0 ~ 1	
W	A960	D	0 ~ 1	
W	B010	D	0 ~ 1	
W	B020	D	0 ~ 1	
W	B110	D	0 ~ 1	
W	B120	D	0 ~ 1	
W	B130	D	0 ~ 1	
W	B140	D	0 ~ 1	
W	B150	D	0 ~ 1	
W	B160	D	0 ~ 1	
W	B410	D	0 ~ 1	
W	B420	D	0 ~ 1	
W	B510	D	0 ~ 1	
W	B520	D	0 ~ 1	
W	B530	D	0 ~ 1	
W	B540	D	0 ~ 1	
W	B550	D	0 ~ 1	
W	B560	D	0 ~ 1	
W	B810	D	0 ~ 1	
W	B820	D	0 ~ 1	
W	B910	D	0 ~ 1	
W	B920	D	0 ~ 1	
W	B930	D	0 ~ 1	
W	B940	D	0 ~ 1	
W	B950	D	0 ~ 1	
W	B960	D	0 ~ 1	
W	B210	D	0 ~ 1	
W	B211	D	0 ~ 1	
W	B212	D	0 ~ 1	
W	B213	D	0 ~ 1	
W	B214	D	0 ~ 1	



Bit/Word	Device type	Format	Range	Memo
W	B310	D	0 ~ 1	
W	B311	D	0 ~ 1	
W	B312	D	0 ~ 1	
W	B313	D	0 ~ 1	
W	B320	D	0 ~ 1	
W	B321	D	0 ~ 1	
W	B322	D	0 ~ 1	
W	B323	D	0 ~ 1	
W	B330	D	0 ~ 1	
W	B331	D	0 ~ 1	
W	B332	D	0 ~ 1	
W	B333	D	0 ~ 1	
W	B340	D	0 ~ 1	
W	B341	D	0 ~ 1	
W	B342	D	0 ~ 1	
W	B343	D	0 ~ 1	
W	C010	D	0 ~ 1	
W	C011	D	0 ~ 1	
W	C020	D	0 ~ 1	
W	C021	D	0 ~ 1	
W	C022	D	0 ~ 1	
W	C030	D	0 ~ 1	
W	C031	D	0 ~ 1	
W	C032	D	0 ~ 1	
W	C033	D	0 ~ 1	
W	C034	D	0 ~ 1	
W	C111	D	0 ~ 1	
W	C112	D	0 ~ 1	
W	C113	D	0 ~ 1	
W	C114	D	0 ~ 1	
W	C115	D	0 ~ 1	
W	C116	D	0 ~ 1	
W	C117	D	0 ~ 1	
W	C118	D	0 ~ 1	
W	C119	D	0 ~ 1	
W	C11A	D	0 ~ 1	
W	C211	D	0 ~ 1	
W	C212	D	0 ~ 1	
W	C310	D	0 ~ 1	
W	C311	D	0 ~ 1	

Bit/Word	Device type	Format	Range	Memo
W	C312	D	0 ~ 1	
W	C313	D	0 ~ 1	
W	C314	D	0 ~ 1	
W	C320	D	0 ~ 1	
W	C321	D	0 ~ 1	
W	C322	D	0 ~ 1	
W	C330	D	0 ~ 1	
W	C331	D	0 ~ 1	
W	C332	D	0 ~ 1	
W	C340	D	0 ~ 1	
W	C341	D	0 ~ 1	
W	C342	D	0 ~ 1	
W	C3A0	D	0 ~ 1	
W	C3A1	D	0 ~ 1	
W	C3A2	D	0 ~ 1	
W	C410	D	0 ~ 1	
W	C411	D	0 ~ 1	
W	C41E	D	0 ~ 1	
W	C510	D	0 ~ 1	
W	C511	D	0 ~ 1	
W	B634	D	0 ~ 1	
W	B635	D	0 ~ 1	



Wiring Diagram:

The following represents the view of HMI & PLC.



eMT3000 series

COM1 RS485 2W 9P D-Sub Male	COM3 RS485 2W 9P D-Sub Male		RS485 terminal
1 RX-	6 Data-		13 RS485B1
2 RX+	9 Data+		12 RS485A1
5 GND	5 GND		
			

MT6000/8000 series except MT6050i/MT8050i

COM1 RS485 2W 9P D-Sub Male	COM3 RS485 2W 9P D-Sub Male		RS485 terminal
1 RX-	6 Data-		13 RS485B1
2 RX+	9 Data+		12 RS485A1
5 GND	5 GND		
			

MT6050i/MT8050i

COM1 RS485 2W 9P D-Sub Female	COM3 RS485 2W 9P D-Sub Female		RS485 terminal
1 RX-	7 Data-		13 RS485B1
2 RX+	8 Data+		12 RS485A1
5 GND	5 GND		
			

Driver Version:

Version	Date	Description
V1.00	Apr/13/2011	Driver released.

DL/T645 Standard

Website: <http://www.cw180.com>

HMI Setting:

Parameters	Recommended	Options	Notes
PLC type	DL/T645 Standard		
PLC I/F	RS485 2W		
Baud rate	9600		
Data bits	8		
Parity	Even		
Stop bits	1		
PLC sta. no.	1		



Device Address:

Bit/Word	Device type	Format	Range	Memo
W	Data	HHHHHHHH	0 ~ 6FFFFFFF	



Wiring Diagram:

The following represents the view of HMI & PLC.



eMT3000 series

COM1 RS485 2W 9P D-Sub Male	COM3 RS485 2W 9P D-Sub Male		RS485 terminal
1 RX-	6 Data-		D-
2 RX+	9 Data+		D+
5 GND	5 GND		
			

MT6000/8000 series except MT6050i/MT8050i

COM1 RS485 2W 9P D-Sub Male	COM3 RS485 2W 9P D-Sub Male		RS485 terminal
1 RX-	6 Data-		D-
2 RX+	9 Data+		D+
5 GND	5 GND		
			

MT6050i/MT8050i

COM1 RS485 2W 9P D-Sub Female	COM3 RS485 2W 9P D-Sub Female		RS485 terminal
1 RX-	7 Data-		D-
2 RX+	8 Data+		D+
5 GND	5 GND		
			

Driver Version:

Version	Date	Description
V1.00	Apr/14/2011	Driver released.

DL-BCM Server

Website: <http://www.hzdelin.com>

HMI Setting:

Parameters	Recommended	Options	Notes
PLC type	DL-BCM Server		
PLC I/F	RS232	RS232, RS485	
Baud rate	9600	9600~115200	
Data bits	8	8	
Parity	None	Even, Odd, None	
Stop bits	1	1	
PLC sta. no.	0	0-31	



Device Address:

Bit/Word	Device type	Format	Range	Memo
B	LB	dddd	0 ~ 9998	
W	LW	dddd	0 ~ 9998	
W	RW	dddddd	0 ~ 55536	





Wiring Diagram:

The following represents the view of HMI & PLC.



eMT3000 series

COM1 RS232 9P D-Sub Female	COM3 RS232 9P D-Sub Female		RS232 9P D-Sub FeMale
2 RX	8 RX		TXD
3 TX	7 TX		RXD
5 GND	5 GND		GND
			RTS
			CTS
			circuit
			



MT6000/8000 series except MT6050i/MT8050i

COM1 RS232 9P D-Sub Female	COM2 RS232 9P D-Sub Female	COM3 RS232 9P D-Sub Male	RS232 9P D-Sub FeMale
2 RX	6 RX	8 RX	TXD
3 TX	4 TX	7 TX	RXD
5 GND	5 GND	5 GND	GND
			RTS
			CTS
			circuit
			



MT6050i/MT8050i

COM1 RS232 9P D-Sub Female			RS232 9P D-Sub FeMale
9 RX			TXD
6 TX			RXD
5 GND			GND
			RTS
			CTS
			circuit
			



The following represents the view of HMI & PLC.
eMT3000 series

COM1 RS485 2W 9P D-Sub Male	COM3 RS485 2W 9P D-Sub Male		RS485 2W 9P D-Sub Male
1 RX-	6 Data-		8 D-
2 RX+	9 Data+		3 D+
5 GND	5 GND		5 GND
			

MT6000/8000 series except MT6050i/MT8050i

COM1 RS485 2W 9P D-Sub Male	COM3 RS485 2W 9P D-Sub Male		RS485 2W 9P D-Sub Male
1 RX-	6 Data-		8 D-
2 RX+	9 Data+		3 D+
5 GND	5 GND		5 GND
			

MT6050i/MT8050i

COM1 RS485 2W 9P D-Sub Female	COM3 RS485 2W 9P D-Sub Female		RS485 2W 9P D-Sub Male
1 RX-	7 Data-		8 D-
2 RX+	8 Data+		3 D+
5 GND	5 GND		5 GND
			

Driver Version:

Version	Date	Description
V1.00	Dec/8/2008	Driver released

EMERSON Charge Module

Website: <http://www.emersonnetworkpower.com.cn/Pages/Default.aspx>

HMI Setting:

Parameters	Recommended	Options	Notes
PLC type	EMERSON Charge Module		
PLC I/F	RS-232		
Baud rate	9600		
Data bits	8		
Parity	Odd		
Stop bits	1		
PLC sta. no.	1		



Device Address:

Bit/Word	Device type	Format	Range	Memo
B	Float_Point_Forced	D	0 ~ 1	
B	Average_Point_Forced	D	0 ~ 1	
W	Switch_Status	D	0 ~ 1	
W	Manual_Status	D	0 ~ 1	
W	Protect_Status	D	0 ~ 1	
W	Failure_Status	D	0 ~ 1	
W	Preset_Voltage	D	0 ~ 1	
W	Preset_Percent	D	0 ~ 1	
W	Output_Voltage	D	0 ~ 1	
W	Output_Current	D	0 ~ 1	
W	High_Limit	D	0 ~ 1	
W	Low_Limit	D	0 ~ 1	
W	Float_Point_Setting	D	0 ~ 1	
W	Average_Point_Setting	D	0 ~ 1	





Wiring Diagram:

The following represents the view of HMI & PLC.



eMT3000 series

COM1 RS232 9P D-Sub Female	COM3 RS232 9P D-Sub Female		RS232 terminal
2 RX	8 RX		TXD
3 TX	7 TX		RXD
5 GND	5 GND		GND
			

MT6000/8000 series except MT6050i/MT8050i

COM1 RS232 9P D-Sub Female	COM2 RS232 9P D-Sub Female	COM3 RS232 9P D-Sub Male	RS232 terminal
2 RX	6 RX	8 RX	TXD
3 TX	4 TX	7 TX	RXD
5 GND	5 GND	5 GND	GND
			

MT6050i/MT8050i

COM1 RS232 9P D-Sub Female			RS232 terminal
9 RX			TXD
6 TX			RXD
5 GND			GND
			

Driver Version:

Version	Date	Description
V1.00	Mar/3/2009	

EMERSON PLC EC20

Supported Series: Emerson PLC EC20 Series. (Modbus RTU Protocol)

HMI Setting:

Parameters	Recommended	Options	Notes
PLC type	EMERSON PLC EC20		
PLC I/F	RS232		
Baud rate	9600	9600, 19200, 115200	
Data bits	8	7 or 8	
Parity	Even	Even, Odd, None	
Stop bits	1	1 or 2	
PLC sta. no.	0	0-255	

PLC Setting:

Communication mode	Modbus RTU protocol
--------------------	---------------------



Device Address:

Bit/Word	Device type	Format	Range	Memo
B	Y	OOO	0 ~ 377	0000-02550
B	X	OOO	0 ~ 377	1200-01455 0000-0255
B	M	DDDD	0 ~ 1999	2000-3999
B	SM	DDD	0~ 255	4400-4655
B	S	DDD	0 ~ 991	6000-6991
B	T	DDD	0 ~ 255	8000-8255
B	C	DDD	0 ~ 255	9200-9455
W	D	DDDD	0 ~ 7999	0000-7999
W	SD	DDD	0 ~ 255	8000-8255
W	Z	DD	0 ~ 15	8500-8515
W	T	DDD	0 ~ 255	9000-9255
W	C	DDD	0 ~ 199	9500-9699
DW	C_Double	DDD	200 ~ 255	9700-9811
DW	D_Double	DDDD	0 ~ 7998	0000-7999





Wiring Diagram:

The following represents the view of HMI & PLC.



eMT3000 series

COM1 RS232 9P D-Sub Female	COM3 RS232 9P D-Sub Female		Emerson EC20 COM1 terminal
2 RX	8 RX		TXD
3 TX	7 TX		RXD
5 GND	5 GND		GND
			

MT6000/8000 series except MT6050i/MT8050i

COM1 RS232 9P D-Sub Female	COM2 RS232 9P D-Sub Female	COM3 RS232 9P D-Sub Male	Emerson EC20 COM1 terminal
2 RX	6 RX	8 RX	TXD
3 TX	4 TX	7 TX	RXD
5 GND	5 GND	5 GND	GND
			

MT6050i/MT8050i

COM1 RS232 9P D-Sub Female			Emerson EC20 COM1 terminal
9 RX			TXD
6 TX			RXD
5 GND			GND
			

Driver Version:

Version	Date	Description
V1.10	Dec/30/2008	

FATEK FB Series

Supported Series: FATEK FBs series, FB MC series, and FB MA series need FB-DTBR converter.

Website: <http://www.fatek.com/>

HMI Setting:

Parameters	Recommended	Options	Notes
PLC type	FATEK FB Series		
PLC I/F	RS232	RS232/RS485	
Baud rate	9600		
Data bits	7		
Parity	Even		
Stop bits	1		
PLC sta. no.	1	0-255	Must match PLC port setting.
TCP port no.	500		Ethernet only.

Device Address:

Bit/Word	Device type	Format	Range	Memo
B	X	DDDD	0 ~ 9999	Input
B	Y	DDDD	0 ~ 9999	Output
B	M	DDDD	0 ~ 9999	Internal Relay
B	S	DDDD	0 ~ 9999	Step Relay
B	T	DDDD	0 ~ 9999	Timer
B	C	DDDD	0 ~ 9999	Counter
B	PLC_MODE	D	0	PLC mode
B	R_Bit	DDDDdd	0 ~ 999915	
B	D_Bit	DDDDdd	0 ~ 999915	
W	RT	DDDD	0 ~ 9999	Timer Register
W	RC	DDDD	0 ~ 9999	Counter Register
W	R	DDDD	0 ~ 9999	Data Register
W	D	DDDD	0 ~ 9999	Data Register
W	DRT	DDDD	0 ~ 9999	Double Word Timer Register
W	DRC	DDD	200 ~ 255	Double Word Counter Register
W	WX	DDDD	0 ~ 9999	Input Word
W	WY	DDDD	0 ~ 9999	Output Word



Bit/Word	Device type	Format	Range	Memo
W	WM	DDDD	0 ~ 9999	Internal Relay Word
W	WS	DDDD	0 ~ 9999	
W	FR	DDDD	0 ~ 9999	

Wiring Diagram:





The following represents the view of HMI & PLC.

9P D-Sub to 4P Mini-DIN: FBs Port0



eMT3000 series

COM1 RS232 9P D-Sub Female	COM3 RS232 9P D-Sub Female		FBs RS232 4P Mini-DIN Male
2 RX	8 RX		3 TX
3 TX	7 TX		4 RX
5 GND	5 GND		2 GND
			

MT6000/8000 series except MT6050i/MT8050i

COM1 RS232 9P D-Sub Female	COM2 RS232 9P D-Sub Female	COM3 RS232 9P D-Sub Male	FBs RS232 4P Mini-DIN Male
2 RX	6 RX	8 RX	3 TX
3 TX	4 TX	7 TX	4 RX
5 GND	5 GND	5 GND	2 GND
			



MT6050i/MT8050i

COM1 RS232 9P D-Sub Female			FBs RS232 4P Mini-DIN Male
9 RX			3 TX
6 TX			4 RX
5 GND			2 GND
			





The following represents the view of HMI & PLC.

9P D-Sub to 9P D-Sub: FBs communication module



eMT3000 series

COM1 RS232 9P D-Sub Female	COM3 RS232 9P D-Sub Female		FBs communication module RS232 9P D-Sub Male
2 RX	8 RX		2 TX
3 TX	7 TX		3 RX
5 GND	5 GND		5 GND
			

MT6000/8000 series except MT6050i/MT8050i

COM1 RS232 9P D-Sub Female	COM2 RS232 9P D-Sub Female	COM3 RS232 9P D-Sub Male	FBs communication module RS232 9P D-Sub Male
2 RX	6 RX	8 RX	2 TX
3 TX	4 TX	7 TX	3 RX
5 GND	5 GND	5 GND	5 GND
			



MT6050i/MT8050i

COM1 RS232 9P D-Sub Female			FBs communication module RS232 9P D-Sub Male
9 RX			2 TX
6 TX			3 RX
5 GND			5 GND
			



The following represents the view of HMI & PLC.

FBs communication module 3P Terminal Block



eMT3000 series

COM1 RS485 2W 9P D-Sub Male	COM3 RS485 2W 9P D-Sub Male		FBs communication module 3P Terminal
1 RX-	6 Data-		D-
2 RX+	9 Data+		D+
5 GND	5 GND		
			

MT6000/8000 series except MT6050i/MT8050i

COM1 RS485 2W 9P D-Sub Male	COM3 RS485 2W 9P D-Sub Male		FBs communication module 3P Terminal
1 RX-	6 Data-		D-
2 RX+	9 Data+		D+
5 GND	5 GND		
			



MT6050i/MT8050i

COM1 RS485 2W 9P D-Sub Female	COM3 RS485 2W 9P D-Sub Female		FBs communication module 3P Terminal
1 RX-	7 Data-		D-
2 RX+	8 Data+		D+
5 GND	5 GND		
			



The following represents the view of HMI & PLC.

9P D-Sub to 15P D-Sub: CPU Port

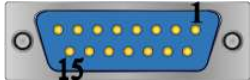
eMT3000 series

COM1 RS232 9P D-Sub Female	COM3 RS232 9P D-Sub Female		FB CPU Port RS232 15P D-Sub Male
2 RX	8 RX		2 TX
3 TX	7 TX		1 RX
5 GND	5 GND		6 GND
			3 RTS
			4 CTS
			circuit
			

MT6000/8000 series except MT6050i/MT8050i

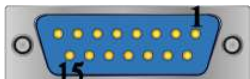
COM1 RS232 9P D-Sub Female	COM2 RS232 9P D-Sub Female	COM3 RS232 9P D-Sub Male	FB CPU Port RS232 15P D-Sub Male
2 RX	6 RX	8 RX	2 TX
3 TX	4 TX	7 TX	1 RX
5 GND	5 GND	5 GND	6 GND
			3 RTS
			4 CTS
			circuit
			

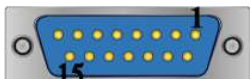

MT6050i/MT8050i

COM1 RS232 9P D-Sub Female			FB CPU Port RS232 15P D-Sub Male
9 RX			2 TX
6 TX			1 RX
5 GND			6 GND
			3 RTS
			4 CTS
			circuit
			



The following represents the view of HMI & PLC.

9P D-Sub to 15P D-Sub: CPU Port RS485 2W

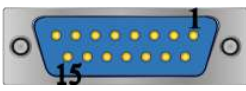

eMT3000 series

COM1 RS485 2W 9P D-Sub Male	COM3 RS485 2W 9P D-Sub Male		FB CPU Port RS485 2W 15P D-Sub Male
1 RX-	6 Data-		7 D-
2 RX+	9 Data+		5 D+
5 GND	5 GND		
			

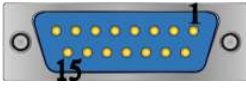
MT6000/8000 series except MT6050i/MT8050i

COM1 RS485 2W 9P D-Sub Male	COM3 RS485 2W 9P D-Sub Male		FB CPU Port RS485 2W 15P D-Sub Male
1 RX-	6 Data-		7 D-
2 RX+	9 Data+		5 D+
5 GND	5 GND		
			

MT6050i/MT8050i

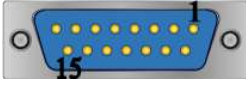
COM1 RS485 2W 9P D-Sub Female	COM3 RS485 2W 9P D-Sub Female		FB CPU Port RS485 2W 15P D-Sub Male
1 RX-	7 Data-		7 D-
2 RX+	8 Data+		5 D+
5 GND	5 GND		
			

Driver Version:

Version	Date	Description
V1.60	Feb/17/2011	R_Bit, D_Bit and WS address types are added.
V1.70	Nov/29/2011	FR address types are added.

Fuji NB Series

Website: <http://www.fujielectric.co.jp/fcs/eng/>

HMI Setting:

Parameters	Recommended	Options	Notes
PLC type	Fuji NB Series		
PLC I/F	RS485 4W		
Baud rate	19200		
Data bits	8		
Parity	Odd		
Stop bits	1		
PLC sta. no.	0		

PLC Setting:

Communication mode	NITP Protocol / PLC Password (default is 0)
--------------------	---



Device Address:

Bit/Word	Device type	Format	Range	Memo
B	Y	HHH	0 ~ 7ff	Output Relay
B	X	HHH	0 ~ 3ff	Input Relay
B	M	HHH	0 ~ fff	Internal Relay
B	L	HHH	0 ~ fff	Latch Relay
B	C	HH	0 - ff	Counter
B	M_Spe	HHHH	0 ~ 81ff	Special Relay
B	T	HHH	0 ~ 1ff	Timer
W	TV	HHH	0 ~ 3ff	Timer value
W	CV	HHH	0 ~ 3ff	Counter value
W	D	HHHH	0 ~ 1fff	Data Register
W	D_Spe	HHHH	0 ~ 81ff	Special Register



Wiring Diagram:

The following represents the view of HMI & PLC.



eMT3000 series

COM1 RS485 4W 9P D-Sub Male			Fuji NB Series RS422 8P RJ45 Male
1 RX-			4 TX-
2 RX+			3 TX+
3 TX-			6 RX-
4 TX+			5 RX+
5 GND			
			

MT6000/8000 series except MT6050i/MT8050i

COM1 RS485 4W 9P D-Sub Male			Fuji NB Series RS422 8P RJ45 Male
1 RX-			4 TX-
2 RX+			3 TX+
3 TX-			6 RX-
4 TX+			5 RX+
5 GND			
			

MT6050i/MT8050i

COM1 RS485 4W 9P D-Sub Female			Fuji NB Series RS422 8P RJ45 Male
1 RX-			4 TX-
2 RX+			3 TX+
3 TX-			6 RX-
4 TX+			5 RX+
5 GND			
			

Driver Version:

Version	Date	Description
V1.10	May/05/2009	

GE Fanuc 0i MD

Website: http://www.fanucfa.com/welcome_worldwide/

HMI Setting:

Parameters	Recommended	Options	Notes
PLC type	GE Fanuc 0i MD		
PLC I/F	RS232		
Baud rate	19200		
Data bits	8		
Parity	Even		
Stop bits	1		
PLC sta. no.	0		

On-line simulation	YES
--------------------	-----

PLC Setting:

Reader/Puncher interface (2ch.) is used for touch panel interface.

External touch panel interface, S/N: A02B-0320-J685, for Power Mate Series.



Device Address:

Bit/Word	Device type	Format	Range	Memo
B	X	DDDDo	0 ~ 11277	
B	Y	DDDDo	0 ~ 11277	
B	K	DDDo	0 ~ 9997	
B	E	DDDDo	0 ~ 99997	
B	D_Bit	DDDDo	0 ~ 99997	
B	R_Bit	DDDDo	0 ~ 94997	
W	T	DDDD	0 ~ 9499	Must be a multiple of 2
W	C	DDDD	0 ~ 5199	Must be a multiple of 4
W	D_Byte	DDDD	0 ~ 9999	
W	R_Byte	DDDD	0 ~ 9499	
W	D	DDDD	0 ~ 9999	Must be a multiple of 2
W	R	DDDD	0 ~ 9499	Must be a multiple of 2



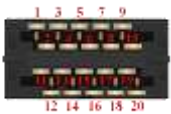

Wiring Diagram:

The following represents the view of HMI & PLC.



eMT3000 series

COM1 RS232 9P D-Sub Female	COM3 RS232 9P D-Sub Female		RS232 20P JD36B or JD54 Female
2 RX	8 RX		11 TX
3 TX	7 TX		1 RX
5 GND	5 GND		8(JD36) 4(JD54) GND
			15 RTS
			05 CTS
			03 DR
			07 CD
			13 ER
			circuit
			circuit
			 

MT6000/8000 series except MT6050i/MT8050i

COM1 RS232 9P D-Sub Female	COM2 RS232 9P D-Sub Female	COM3 RS232 9P D-Sub Male	RS232 20P JD36B or JD54 Female
2 RX	6 RX	8 RX	11 TX
3 TX	4 TX	7 TX	1 RX
5 GND	5 GND	5 GND	8(JD36) 4(JD54) GND
			15 RTS
			05 CTS
			03 DR
			07 CD
			13 ER
			circuit
			circuit
			 

MT6050i/MT8050i

COM1 RS232 9P D-Sub Female			RS232 20P JD36B or JD54 Female
9 RX			11 TX
6 TX			1 RX
5 GND			8(JD36) 4(JD54) GND
			15 RTS
			05 CTS
			03 DR
			07 CD
			13 ER
			circuit
			circuit
			

Driver Version:

Version	Date	Description
V1.00	May/16/2011	Driver released.

GE Fanuc CMM

Website: <http://www.ge.com>

HMI Setting:

Parameters	Recommended	Options	Notes
PLC type	GE Fanuc CMM		
PLC I/F	RS232	RS232/RS485	
Baud rate	19200	9600,19200,38400,57600,115200	
Data bits	8	7,8	Must set to 8 for this protocol
Parity	Odd	Even, Odd, None	
Stop bits	1	1, 2	
PLC sta. no.	0	0-255	Does not apply to this protocol

PLC Setting:

Refer to the related PLC manual.

Device Address:

Bit/Word	Device type	Format	Range	Memo
B	I	DDDDD	1 ~ 10000	Input relay
B	Q	DDDDD	1 ~ 10000	Output relay
B	M	DDDDD	1 ~ 10000	Auxiliary relay
B	G	DDDD	1 ~ 7680	
B	T	DDD	1 ~ 256	
B	SA	DDD	1 ~ 128	
B	SB	DDD	1 ~ 128	
B	SC	DDD	1 ~ 128	
B	S	DDD	1 ~ 128	
W	AI	DDDDD	1 ~ 10000	Analog input register
W	AQ	DDDDD	1 ~ 10000	Analog output register
W	R	DDDDD	1 ~ 32640	Data register

Wiring Diagram:

The following represents the view of HMI & PLC.

CPU Port 90-30/VersaMax

eMT3000 series

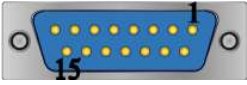
COM1 RS485 4W 9P D-Sub Male			90-30/VersaMax RS485 4W 15P D-Sub Male
1 RX-			12 SDA
2 RX+			13 SDB
5 GND			7 GND
3 TX-			10 RDA
4 TX+			11 RDB
			9 RT
			6 RTSA
			15 CTSA
			8 RTSB
			14 CTSB
			circuit
			circuit
			circuit
			

MT6000/8000 series except MT6050i/MT8050i

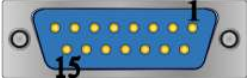
COM1 RS485 4W 9P D-Sub Male			90-30/VersaMax RS485 4W 15P D-Sub Male
1 RX-			12 SDA
2 RX+			13 SDB
5 GND			7 GND
3 TX-			10 RDA
4 TX+			11 RDB
			9 RT
			6 RTSA
			15 CTSA
			8 RTSB
			14 CTSB
			circuit
			circuit
			circuit
			

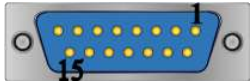

MT6050i/MT8050i

COM1 RS485 4W 9P D-Sub Female			90-30/VersaMax RS485 4W 15P D-Sub Male
1 RX-			12 SDA
2 RX+			13 SDB
5 GND			7 GND
3 TX-			10 RDA
4 TX+			11 RDB
			9 RT
			6 RTSA
			15 CTSA
			8 RTSB
			14 CTSB
			circuit
			circuit
			circuit
			





The following represents the view of HMI & PLC.

CPU Port (90-30 series CPU351/352/363/364)



eMT3000 series

COM1 RS232 9P D-Sub Female	COM3 RS232 9P D-Sub Female		90-30/90-70 series RS232 6P RJ11 Male
2 RX	8 RX		2 TX
3 TX	7 TX		5 RX
5 GND	5 GND		3 GND
			

MT6000/8000 series except MT6050i/MT8050i

COM1 RS232 9P D-Sub Female	COM2 RS232 9P D-Sub Female	COM3 RS232 9P D-Sub Male	90-30/90-70 series RS232 6P RJ11 Male
2 RX	6 RX	8 RX	2 TX
3 TX	4 TX	7 TX	5 RX
5 GND	5 GND	5 GND	3 GND
			



MT6050i/MT8050i

COM1 RS232 9P D-Sub Female			90-30/90-70 series RS232 6P RJ11 Male
9 RX			2 TX
6 TX			5 RX
5 GND			3 GND
			





The following represents the view of HMI & PLC.

CPU Port (VersaMax series CPU001/002/005/E05)



eMT3000 series

COM1 RS232 9P D-Sub Female	COM3 RS232 9P D-Sub Female		VersaMax series RS232 9P D-Sub Male
2 RX	8 RX		2 TX
3 TX	7 TX		3 RX
5 GND	5 GND		5 GND
			

MT6000/8000 series except MT6050i/MT8050i

COM1 RS232 9P D-Sub Female	COM2 RS232 9P D-Sub Female	COM3 RS232 9P D-Sub Male	VersaMax series RS232 9P D-Sub Male
2 RX	6 RX	8 RX	2 TX
3 TX	4 TX	7 TX	3 RX
5 GND	5 GND	5 GND	5 GND
			

MT6050i/MT8050i

COM1 RS232 9P D-Sub Female			VersaMax series RS232 9P D-Sub Male
9 RX			2 TX
6 TX			3 RX
5 GND			5 GND
			

Driver Version:

Version	Date	Description
V1.00	Jul/09/2009	Driver released.

GE Fanuc RX3i

Website: <http://www.ge.com>

HMI Setting:

Parameters	Recommended	Options	Notes
PLC type	GE Fanuc RX3i		
PLC I/F	RS232	RS232, RS485	
Baud rate	19200	1200~115200	
Data bits	8		
Parity	Odd	None, Even, Odd	
Stop bits	1	1 or 2	
PLC sta. no.	1	1~99	

PLC Setting:

Refer to the related PLC manual.



Device Address:

Bit/Word	Device type	Format	Range	Memo
B	I	DDDDD	1 ~ 32768	
B	Q	DDDDD	1 ~ 32768	
B	M	DDDDD	1 ~ 32768	
B	G	DDDDD	1 ~ 32768	
B	T	DDDDD	1 ~ 32768	
B	SA	DDDDD	1 ~ 32768	
B	SB	DDDDD	1 ~ 32768	
B	SC	DDDDD	1 ~ 32768	
B	S	DDDDD	1 ~ 32768	
W	AI	DDDDD	1 ~ 32768	
W	AQ	DDDDD	1 ~ 32768	
W	R	DDDDD	1 ~ 32768	





Wiring Diagram:

The following represents the view of HMI & PLC.



eMT3000 series

COM1 RS232 9P D-Sub Female	COM3 RS232 9P D-Sub Female		GE Fanuc RX3i COM1 RS232 9P D-Sub Male
2 RX	8 RX		2 TXD
3 TX	7 TX		3 RXD
5 GND	5 GND		5 GND
			

MT6000/8000 series except MT6050i/MT8050i

COM1 RS232 9P D-Sub Female	COM2 RS232 9P D-Sub Female	COM3 RS232 9P D-Sub Male	GE Fanuc RX3i COM1 RS232 9P D-Sub Male
2 RX	6 RX	8 RX	2 TXD
3 TX	4 TX	7 TX	3 RXD
5 GND	5 GND	5 GND	5 GND
			

MT6050i/MT8050i

COM1 RS232 9P D-Sub Female			GE Fanuc RX3i COM1 RS232 9P D-Sub Male
9 RX			2 TXD
6 TX			3 RXD
5 GND			5 GND
			

The following represents the view of HMI & PLC.

GE Fanuc RX3i COM2

eMT3000 series

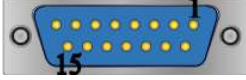
COM1 RS485 4W 9P D-Sub Male			GE Fanuc RX3i COM2 RS232 15P D-Sub Male	
1 RX-			12 SDA	
2 RX+			13 SDB	
5 GND			7 GND	
3 TX-			10 RDA	
4 TX+			11 RDB	
			9 RT	circuit
			6 RTSA	
			15 CTSA	circuit
			8 RTSB	
			14 CTSB	
				

MT6000/8000 series except MT6050i/MT8050i

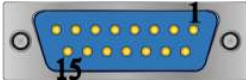
COM1 RS485 4W 9P D-Sub Male			GE Fanuc RX3i COM2 RS232 15P D-Sub Male	
1 RX-			12 SDA	
2 RX+			13 SDB	
5 GND			7 GND	
3 TX-			10 RDA	
4 TX+			11 RDB	
			9 RT	circuit
			6 RTSA	
			15 CTSA	circuit
			8 RTSB	
			14 CTSB	
				

MT6050i/MT8050i

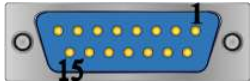
COM1 RS485 4W 9P D-Sub Female			GE Fanuc RX3i COM2 RS232 15P D-Sub Male
1 RX-			12 SDA
2 RX+			13 SDB
5 GND			7 GND
3 TX-			10 RDA
4 TX+			11 RDB
			9 RT
			6 RTSA
			15 CTSA
			8 RTSB
			14 CTSB
			circuit
			circuit
			circuit
			

Driver Version:

Version	Date	Description
V1.10	Oct/01/2010	Driver released.

GE Fanuc Series 90-30 (Ethernet)

Supported Series: GE 90-30 series, CPU model 374plus.

HMI Setting:

Parameters	Recommended	Options	Notes
PLC type	GE Fanuc Series 90-30 (Ethernet)		
PLC I/F	Ethernet		
Port no.	18245		
PLC sta. no.	1	1~99	

Device Address:

Bit/Word	Device type	Format	Range	Memo
B	I_bit	DDDDD	1 ~ 32768	
B	Q_bit	DDDDD	1 ~ 32768	
B	M_bit	DDDDD	1 ~ 32768	
B	G_bit	DDDDD	1 ~ 32768	
B	T_bit	DDDDD	1 ~ 32768	
B	SA_bit	DDDDD	1 ~ 32768	Read Only
B	SB_bit	DDDDD	1 ~ 32768	Read Only
B	SC_bit	DDDDD	1 ~ 32768	Read Only
B	S_bit	DDDDD	1 ~ 32768	Read Only
B	R_bit	DDDDD	1 ~ 32768	
W	I	DDDDD	1 ~ 32753	Address increment by 8 words, ex: I1, I9, I17, I25.....
W	Q	DDDDD	1 ~ 32753	The rule is same as above, ex:Q1, Q9, Q17...
W	M	DDDDD	1 ~ 32753	The rule is same as above, ex:M1, M9, M17..
W	G	DDDDD	1 ~ 32753	The rule is same as above, ex:G1, G9, G17...
W	T	DDDD	1 ~ 1024	The rule is same as above, ex:T1, T9, T17....
W	SA	DDDDD	1 ~ 32753	Read only, the rule is same as above
W	SB	DDDDD	1 ~ 32753	Read only, the rule is same as above

Bit/Word	Device type	Format	Range	Memo
W	SC	DDDDD	1 ~ 32753	Read only, the rule is same as above
W	S	DDDDD	1 ~ 32753	Read only, the rule is same as above
W	R	DDDDD	1 ~ 32768	
W	AI	DDDDD	1 ~ 32768	
W	AQ	DDDDD	1 ~ 32768	
W	W	DDDDDDD	1 ~ 5000000	

Wiring Diagram:

Direct connect (crossover cable):

HMI RJ45 Male	Wire Color	Wire Color	PLC RJ45 Male
1 TX+	White/Orange	White/Green	3 RX+
2 TX-	Orange	Green	6 RX-
3 RX+	White/Green	White/Orange	1 TX+
4 BD4+	Blue	Blue	4 BD4+
5 BD4-	White/Blue	White/Blue	5 BD4-
6 RX-	Green	Orange	2 TX-
7 BD3+	White/Brown	White/Brown	7 BD3+
8 BD3-	Brown	Brown	8 BD3-



Through a hub:

HMI RJ45 Male	Wire Color	Wire Color	PLC RJ45 Male
1 TX+	White/Orange	White/Orange	1 TX+
2 TX-	Orange	Orange	2 TX-
3 RX+	White/Green	White/Green	3 RX+
4 BD4+	Blue	Blue	4 BD4+
5 BD4-	White/Blue	White/Blue	5 BD4-
6 RX-	Green	Green	6 RX-
7 BD3+	White/Brown	White/Brown	7 BD3+
8 BD3-	Brown	Brown	8 BD3-



Driver Version:

Version	Date	Description
V1.70	Apr/09/2010	
V1.80	Nov/09/2011	Add device type : R_bit
V1.90	Jan/17/2012	Add device type : W

GE Fanuc SNP-X

Supported Series: GE Fanuc 90 & VersaMax series PLC

Website: <http://www.ge.com>

HMI Setting:

Parameters	Recommended	Options	Notes
PLC type	GE Fanuc SNP-X		
PLC I/F	RS485 4W	RS232/RS485	
Baud rate	19200	9600, 19200, 38400, 57600, 115200	
Data bits	8	7, 8	Must set to 8 for this protocol
Parity	Odd	Even, Odd, None	
Stop bits	1	1, 2	
PLC sta. no.	0	0-255	Does not apply to this protocol

PLC Setting:

Refer to the related PLC manual.

Device Address:

Bit/Word	Device type	Format	Range	Memo
B	I	DDDDD	1 ~ 10000	Input relay
B	Q	DDDDD	1 ~ 10000	Output relay
B	M	DDDDD	1 ~ 10000	Auxiliary relay
B	G	DDDD	1 ~ 7680	
B	T	DDD	1 ~ 256	
B	SA	DDD	1 ~ 128	
B	SB	DDD	1 ~ 128	
B	SC	DDD	1 ~ 128	
B	S	DDD	1 ~ 128	
W	AI	DDDDD	1 ~ 10000	Analog input register
W	AQ	DDDDD	1 ~ 10000	Analog output register
W	R	DDDDD	1 ~ 32640	Data register

Wiring Diagram:

The following represents the view of HMI & PLC.

CPU Port (90-30/VersaMax)

eMT3000 series

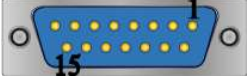
COM1 RS485 4W 9P D-Sub Male			90-30/VersaMax RS422 15P D-Sub Male	
1 RX-			12 SDA	
2 RX+			13 SDB	
5 GND			7 GND	
3 TX-			10 RDA	
4 TX+			11 RDB	
			9 RT	circuit
			6 RTSA	
			15 CTSA	circuit
			8 RTSB	
			14 CTSB	
				

MT6000/8000 series except MT6050i/MT8050i

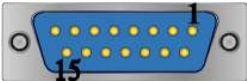
COM1 RS485 4W 9P D-Sub Male			90-30/VersaMax RS422 15P D-Sub Male	
1 RX-			12 SDA	
2 RX+			13 SDB	
5 GND			7 GND	
3 TX-			10 RDA	
4 TX+			11 RDB	
			9 RT	circuit
			6 RTSA	
			15 CTSA	circuit
			8 RTSB	
			14 CTSB	
				

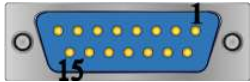

MT6050i/MT8050i

COM1 RS485 4W 9P D-Sub Female			90-30/VersaMax RS422 15P D-Sub Male
1 RX-			12 SDA
2 RX+			13 SDB
5 GND			7 GND
3 TX-			10 RDA
4 TX+			11 RDB
			9 RT
			6 RTSA
			15 CTSA
			8 RTSB
			14 CTSB
			circuit
			circuit
			circuit
			





The following represents the view of HMI & PLC.

CPU Port (90-30 series CPU351/352/363/364)



eMT3000 series

COM1 RS232 9P D-Sub Female	COM3 RS232 9P D-Sub Female		90-30/90-70 series RS232 6P RJ11 Male
2 RX	8 RX		2 TX
3 TX	7 TX		5 RX
5 GND	5 GND		3 GND
			

MT6000/8000 series excepts MT6050i/MT8050i

COM1 RS232 9P D-Sub Female	COM2 RS232 9P D-Sub Female	COM3 RS232 9P D-Sub Male	90-30/90-70 series RS232 6P RJ11 Male
2 RX	6 RX	8 RX	2 TX
3 TX	4 TX	7 TX	5 RX
5 GND	5 GND	5 GND	3 GND
			



MT6050i/MT8050i

COM1 RS232 9P D-Sub Female			90-30/90-70 series RS232 6P RJ11 Male
9 RX			2 TX
6 TX			5 RX
5 GND			3 GND
			





The following represents the view of HMI & PLC.

CPU Port (VersaMax series CPU001/002/005/E05)



eMT3000 series

COM1 RS232 9P D-Sub Female	COM3 RS232 9P D-Sub Female		VersaMax series RS232 9P D-Sub Male
2 RX	8 RX		2 TX
3 TX	7 TX		3 RX
5 GND	5 GND		5 GND
			

MT6000/8000 series except MT6050i/MT8050i

COM1 RS232 9P D-Sub Female	COM2 RS232 9P D-Sub Female	COM3 RS232 9P D-Sub Male	VersaMax series RS232 9P D-Sub Male
2 RX	6 RX	8 RX	2 TX
3 TX	4 TX	7 TX	3 RX
5 GND	5 GND	5 GND	5 GND
			

MT6050i/MT8050i

COM1 RS232 9P D-Sub Female			VersaMax series RS232 9P D-Sub Male
9 RX			2 TX
6 TX			3 RX
5 GND			5 GND
			

Driver Version:

Version	Date	Description
V1.20	Jan/09/2009	

Haiwell PLC

Support Series: E series, S series and H series.

Web: <http://www.haiwell.com/>

HMI Setting:

Parameters	Recommended	Options	Notes
PLC type	Haiwell PLC		
PLC I/F	RS232	RS232,RS485 2W	
Baud rate	19200	19200	
Data bits	8	8	
Parity	None	None	
Stop bits	2	2	
PLC sta. no.	1	1~247	



Device Address:

Bit/Word	Device type	Format	Range	Memo
B	X	DDDD	0 ~ 1023	Input Switch
B	Y	DDDD	0 ~ 1023	Output Switch
B	M	DDDDD	0 ~ 12287	Internal Relay
B	T	DDDD	0 ~ 1023	Timer (Output Coil State)
B	C	DDD	0 ~ 255	Timer (Output Coil State)
B	SM	DDD	0 ~ 215	System Status Bit
B	S	DDDD	0 ~ 2047	Step Bit
W	CR	DD	0 ~ 79	Special Module Parameter Register
W	AI	DDD	0 ~ 255	Analog Input Register
W	AQ	DDD	0 ~ 255	Analog Output Register
W	V	DDDDD	0 ~ 14847	Data Register
W	TCV	DDDD	0 ~ 1023	Timer (current value register)
W	CCV	DDD	0 ~ 255	Timer (current value register)
W	SV	DDD	0 ~ 154	System Register





Wiring Diagram:

The following represents the view of HMI & PLC.



eMT3000 series

COM1 RS232 9P D-Sub Female	COM3 RS232 9P D-Sub Female		RS232 4P Mini-DIN Male
2 RX	8 RX		2 TX
3 TX	7 TX		1 RX
5 GND	5 GND		3 GND
			



MT6000/8000 series except MT6050i/MT8050i

COM1 RS232 9P D-Sub Female	COM2 RS232 9P D-Sub Female	COM3 RS232 9P D-Sub Male	RS232 4P Mini-DIN Male
2 RX	6 RX	8 RX	2 TX
3 TX	4 TX	7 TX	1 RX
5 GND	5 GND	5 GND	3 GND
			



MT6050i/MT8050i

COM1 RS232 9P D-Sub Female			RS232 4P Mini-DIN Male
9 RX			2 TX
6 TX			1 RX
5 GND			3 GND
			



eMT3000 series

COM1 RS485 2W 9P D-Sub Male	COM3 RS485 2W 9P D-Sub Male		RS485 2W Terminal
1 RX-	6 Data-		B- Data+
2 RX+	9 Data+		A+ Data-
5 GND	5 GND		
			

MT6000/8000 series except MT6050i/MT8050i

COM1 RS485 2W 9P D-Sub Male	COM3 RS485 2W 9P D-Sub Male		RS485 2W Terminal
1 RX-	6 Data-		B- Data+
2 RX+	9 Data+		A+ Data-
5 GND	5 GND		
			

MT6050i/MT8050i

COM1 RS485 2W 9P D-Sub Female	COM3 RS485 2W 9P D-Sub Female		RS485 2W Terminal
1 RX-	7 Data-		B- Data+
2 RX+	8 Data+		A+ Data-
5 GND	5 GND		
			

Driver Version:

Version	Date	Description
V1.00	Mar/2/2012	Driver released.

Hangzhou Maiou MO-TECH

Support Series: LS GLOFA series GM3, GM4, GM6, GM7 CPU Port.

Website: <http://www.lgis.com/>

HMI Setting:

Parameters	Recommended	Options	Notes
PLC type	Hangzhou Maiou MO-TECH		
PLC I/F	RS232		
Baud rate	9600		
Data bits	8		
Parity	None		
Stop bits	1		
PLC sta. no.	1		



Device Address:

Bit/Word	Device type	Format	Range	Memo
B	MWX	DDDdd	0 ~ 25515	B
B	MWX_NO_RPS	DDDdd	0 ~ 25515	B
W	MW	DDD	0 ~ 255	W
W	MW_NO_RPS	DDD	0 ~ 255	W





Wiring Diagram:

The following represents the view of HMI & PLC.



eMT3000 series

COM1 RS232 9P D-Sub Female	COM3 RS232 9P D-Sub Female		RS232 Terminal
2 RX	8 RX		TD
3 TX	7 TX		RD
5 GND	5 GND		GND
			

MT6000/8000 series except MT6050i/MT8050i

COM1 RS232 9P D-Sub Female	COM2 RS232 9P D-Sub Female	COM3 RS232 9P D-Sub Male	RS232 Terminal
2 RX	6 RX	8 RX	TD
3 TX	4 TX	7 TX	RD
5 GND	5 GND	5 GND	GND
			

MT6050i/MT8050i

COM1 RS232 9P D-Sub Female			RS232 Terminal
9 RX			TD
6 TX			RD
5 GND			GND
			

Driver Version:

Version	Date	Description
V1.00	Apr/27/2010	

Hanyoung Controller

Supported Series: Temperature Controller.

Website: <http://hynux.com/kor/>

HMI Setting:

Parameters	Recommended	Options	Notes
PLC type	Hanyoung Controller		
PLC I/F	RS485 4W		
Baud rate	9600		
Data bits	8	7 or 8	
Parity	None	Even, Odd, None	
Stop bits	1	1 or 2	
PLC sta. no.	1	0-255	

*In System Parameter Settings / Device Settings / COM Settings, set Parameter 1 to “1” to support Check Sum Mode.

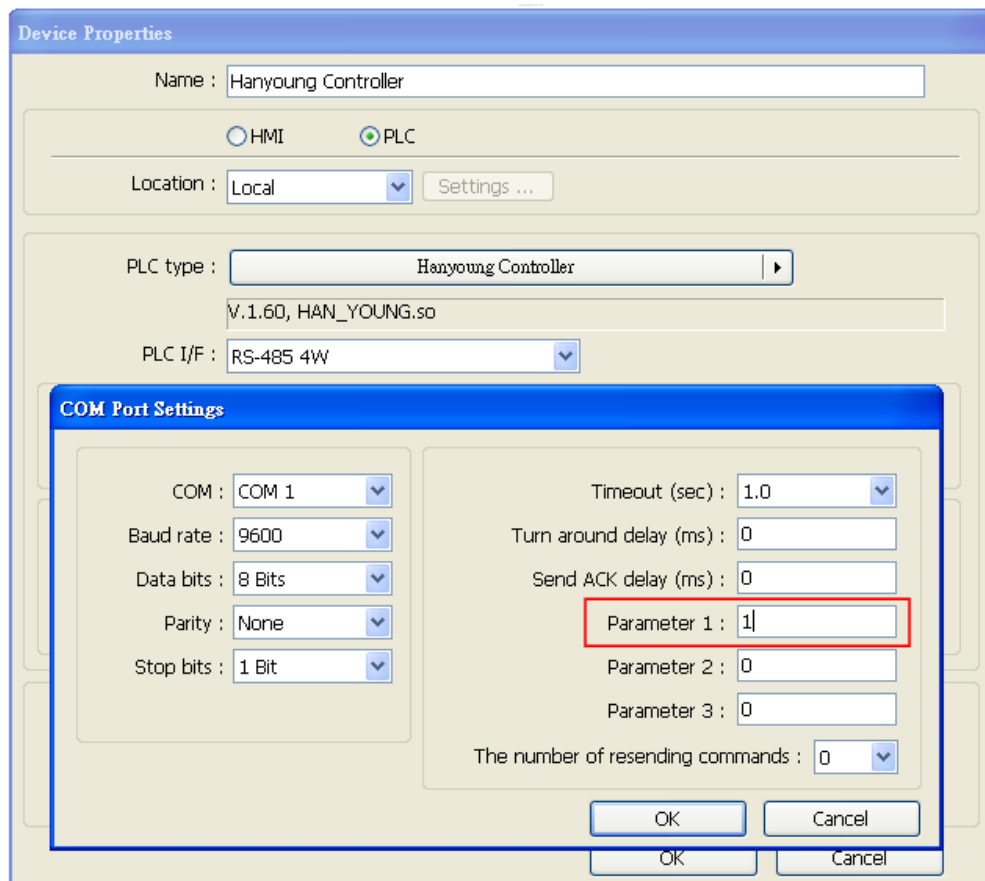



Device Address:

Bit/Word	Device type	Format	Range	Memo
B	I	DDDD	1 ~ 9999	
W	D	DDDD	1 ~ 9999	



Wiring Diagram:

The following represents the view of HMI & PLC.



eMT3000 series

COM1 RS485 4W 9P D-Sub Male			Han Young RS422 terminal
1 RX-			32 TX-
2 RX+			31 TX+
3 TX-			34 RX-
4 TX+			33 RX+
5 GND			
			

MT6000/8000 series except MT6050i/MT8050i

COM1 RS485 4W 9P D-Sub Male			Han Young RS422 terminal
1 RX-			32 TX-
2 RX+			31 TX+
3 TX-			34 RX-
4 TX+			33 RX+
5 GND			
			

MT6050i/MT8050i

COM1 RS485 4W 9P D-Sub Female			Han Young RS422 terminal
1 RX-			32 TX-
2 RX+			31 TX+
3 TX-			34 RX-
4 TX+			33 RX+
5 GND			
			

Driver Version:

Version	Date	Description
V1.60	Jun/14/2010	

HAWE PLVC

Supported Series: HAWE PLVC

Website: <http://www.hawe.de/de/home/>

HMI Setting:

Parameters	Recommended	Options	Notes
PLC type	HAWE PLVC		
PLC I/F	RS232		
Baud rate	9600		
Data bits	8		
Parity	None		
Stop bits	1		
PLC sta. no.	0		



Device Address:

Bit/Word	Device type	Format	Range	Memo
B	X	HHHH	0 ~ ffff	Input Bits
B	Y	HHHH	0 ~ ffff	Output Bits
B	M	DDDDD	0 ~ 65535	Internal Relays
B	T	DDDDD	0 ~ 65535	
B	C	DDDDD	0 ~ 65535	
B	B	HHHH	0 ~ ffff	
B	F	DDDDD	0 ~ 65535	
W	TV	DDDDD	0 ~ 65535	Timer Preset Value
W	CV	DDDDD	0 ~ 65535	Counter Preset Value
W	D	DDDDD	0 ~ 65535	Data Registers
W	W	HHHH	0 ~ ffff	
W	R	DDDDD	0 ~ 65535	





Wiring Diagram:

The following represents the view of HMI & PLC.



eMT3000 series

COM1 RS232 9P D-Sub Female	COM3 RS232 9P D-Sub Female		RS232 terminal
2 RX	8 RX		TXD
3 TX	7 TX		RXD
5 GND	5 GND		GND
			

MT6000/8000 series except MT6050i/MT8050i

COM1 RS232 9P D-Sub Female	COM2 RS232 9P D-Sub Female	COM3 RS232 9P D-Sub Male	RS232 terminal
2 RX	6 RX	8 RX	TXD
3 TX	4 TX	7 TX	RXD
5 GND	5 GND	5 GND	GND
			

MT6050i/MT8050i

COM1 RS232 9P D-Sub Female			RS232 terminal
9 RX			TXD
6 TX			RXD
5 GND			GND
			

Driver Version:

Version	Date	Description
V1.00	Sep/17/2009	

Heng Yuan EU series

Supported Series: EU series, EU5 series, EU10 series.

Website: <http://www.tjhysensor.cn/>

HMI Setting:

Parameters	Recommended	Options	Notes
PLC type	Heng Yuan EU series		
PLC I/F	RS485 2W		
Baud rate	9600		
Data bits	8		
Parity	Even		
Stop bits	1		
PLC sta. no.	2	1-31	

Online simulator	YES	
Extend address mode	YES	



Device Address:

Bit/Word	Device type	Format	Range	Memo
W	Parameter	DDDD	0 ~ 2000	



Wiring Diagram:

The following represents the view of HMI & PLC.



eMT3000 series

COM1 RS485 2W 9P D-Sub Male	COM3 RS485 2W 9P D-Sub Male		Heng Yuan Sensor RS485
1 RX-	6 Data-		7 RX- (Yellow)
2 RX+	9 Data+		6 RX+ (Green)
5 GND	5 GND		4 GND (Black)
			

MT6000/8000 series except MT6050i/MT8050i

COM1 RS485 2W 9P D-Sub Male	COM3 RS485 2W 9P D-Sub Male		Heng Yuan Sensor RS485
1 RX-	6 Data-		7 RX- (Yellow)
2 RX+	9 Data+		6 RX+ (Green)
5 GND	5 GND		4 GND (Black)
			

MT6050i/MT8050i

COM1 RS485 2W 9P D-Sub Female	COM3 RS485 2W 9P D-Sub Female		Heng Yuan Sensor RS485
1 RX-	7 Data-		7 RX- (Yellow)
2 RX+	8 Data+		6 RX+ (Green)
5 GND	5 GND		4 GND (Black)
			

Driver Version:

Version	Date	Description
V1.00	Dec/30/2008	Driver released.

Hitachi EH-SIO

HMI Setting:

Parameters	Recommended	Options	Notes
PLC type	Hitachi EH-SIO		
PLC I/F	RS232	RS232, RS485	
Baud rate	19200	9600, 19200, 38400	
Data bits	7	7	
Parity	Even	Even	
Stop bits	1	1	
PLC sta. no.	0		

PLC Setting:

Communication mode	19200, E, 7, 1 (default)
--------------------	--------------------------

Device Address:



Bit/Word	Device type	Format	Range	Memo
B	X	HHHHh	0 ~ ffff	External input-bit (X)
B	Y	HHHHh	0 ~ ffff	External output-bit (Y)
B	M	HHHHh	0 ~ ffff	Data area-bit (M)
B	T	HHHHh	0 ~ ffff	Timer (T)
B	R	HHHHh	0 ~ ffff	Internal output (R)
B	L	HHHHh	0 ~ ffff	Link area-bit (L)
W	TC	HH	0 ~ ff	Timer/Counter current value
W	WM	HHHH	0 ~ 270f	Data area-word (M)
W	WX	HHHH	0 ~ 270f	External input-word (X)
W	WY	HHHH	0 ~ 270f	External output-word (Y)
W	WR	HHHH	0 ~ 270f	Internal output-word (R)
W	WL	HHHH	0 ~ 270f	Link area-word (L)

Wiring Diagram:





The following represents the view of HMI & PLC.

EH-SIO port1/port 2 RS232



eMT3000 series

COM1 RS232 9P D-Sub Female	COM3 RS232 9P D-Sub Female		RS232 8P RJ45 Male
2 RX	8 RX		5 SD
3 TX	7 TX		6 RD
5 GND	5 GND		1 SG
8 CTS			8 RS
			4 PHL
			7 DR
			circuit
			

MT6000/8000 series except MT6050i/MT8050i

COM1 RS232 9P D-Sub Female	COM2 RS232 9P D-Sub Female	COM3 RS232 9P D-Sub Male	RS232 8P RJ45 Male
2 RX	6 RX	8 RX	5 SD
3 TX	4 TX	7 TX	6 RD
5 GND	5 GND	5 GND	1 SG
8 CTS			8 RS
			4 PHL
			7 DR
			circuit
			



MT6050i/MT8050i

COM1 RS232 9P D-Sub Female			RS232 8P RJ45 Male
9 RX			5 SD
6 TX			6 RD
5 GND			1 SG
			8 RS
			4 PHL
			7 DR
			circuit
			



The following represents the view of HMI & PLC.

EH-SIO port2 RS485 4W



eMT3000 series

COM1 RS485 4W 9P D-Sub Male			Hitachi EH-SIO
1 RX-			2 TX-
2 RX+			1 TX+
3 TX-			4 RX-
4 TX+			3 RX+
5 GND			6 SG
			

MT6000/8000 series except MT6050i/MT8050i

COM1 RS485 4W 9P D-Sub Male			Hitachi EH-SIO
1 RX-			2 TX-
2 RX+			1 TX+
3 TX-			4 RX-
4 TX+			3 RX+
5 GND			6 SG
			



MT6050i/MT8050i

COM1 RS485 4W 9P D-Sub Female			Hitachi EH-SIO
1 RX-			2 TX-
2 RX+			1 TX+
3 TX-			4 RX-
4 TX+			3 RX+
5 GND			6 SG
			



The following represents the view of HMI & PLC.

EH-SIO port2 RS485 2W



eMT3000 series

COM1 RS485 2W 9P D-Sub Male	COM3 RS485 2W 9P D-Sub Male		Hitachi EH-SIO
1 RX-	6 Data-		2 TX-
			4 RX-
2 RX+	9 Data+		1 TX+
			3 RX+
5 GND	5 GND		6 SG
			

MT6000/8000 series except MT6050i/MT8050i

COM1 RS485 2W 9P D-Sub Male	COM3 RS485 2W 9P D-Sub Male		Hitachi EH-SIO
1 RX-	6 Data-		2 TX-
			4 RX-
2 RX+	9 Data+		1 TX+
			3 RX+
5 GND	5 GND		6 SG
			

MT6050i/MT8050i

COM1 RS485 2W 9P D-Sub Female	COM3 RS485 2W 9P D-Sub Female		Hitachi EH-SIO	
1 RX-	7 Data-		2 TX-	circuit
			4 RX-	
2 RX+	8 Data+		1 TX+	circuit
			3 RX+	
5 GND	5 GND		6 SG	
				

Driver Version:

Version	Date	Description
V1.00	May/25/2010	Driver released.

Hitachi EHV Series (Ethernet)

Website: <http://www.hitachi-ies.co.jp/english/products/plc/index.htm>

HMI Setting:

Parameters	Recommended	Options	Notes
PLC type	Hitachi EHV Series (Ethernet)		
PLC I/F	Ethernet		
Port no.	3004	3004~3007	

Device Address:

Bit/Word	Device type	Format	Range	Memo
B	X	HHHHh	0 ~ ffff	External input-bit (X)
B	Y	HHHHh	0 ~ ffff	External output-bit (Y)
B	M	HHHHh	0 ~ ffff	Data area-bit (M)
B	T	DDDDD	0 ~ 65535	Timer (T)
B	R	HHHHh	0 ~ ffff	Internal output (R)
B	L	HHHHh	0 ~ ffff	Link area-bit (L)
W	TC	DDDD	0 ~ 2559	Timer/Counter current value
W	WM	HHHH	0 ~ 7fff	Data area-word (M)
W	WX	HHHH	0 ~ ffff	External Input-word (X)
W	WY	HHHH	0 ~ ffff	External output-word (Y)
W	WR	HHHH	0 ~ ffff	Internal output-word (R)
W	WL	HHHH	0 ~ 73ff	Link area-word (L)

Wiring Diagram:

Direct connect (crossover cable):

HMI RJ45 Male	Wire Color	Wire Color	PLC RJ45 Male
1 TX+	White/Orange	White/Green	3 RX+
2 TX-	Orange	Green	6 RX-
3 RX+	White/Green	White/Orange	1 TX+
4 BD4+	Blue	Blue	4 BD4+
5 BD4-	White/Blue	White/Blue	5 BD4-
6 RX-	Green	Orange	2 TX-
7 BD3+	White/Brown	White/Brown	7 BD3+
8 BD3-	Brown	Brown	8 BD3-



Through a hub:

HMI RJ45 Male	Wire Color	Wire Color	PLC RJ45 Male
1 TX+	White/Orange	White/Orange	1 TX+
2 TX-	Orange	Orange	2 TX-
3 RX+	White/Green	White/Green	3 RX+
4 BD4+	Blue	Blue	4 BD4+
5 BD4-	White/Blue	White/Blue	5 BD4-
6 RX-	Green	Green	6 RX-
7 BD3+	White/Brown	White/Brown	7 BD3+
8 BD3-	Brown	Brown	8 BD3-



Driver Version:

Version	Date	Description
V1.00	Jan/12/2010	Driver released

Hitachi H/EH/EHV Series

Supported Series: Hitachi H series, EH-150, Micro-EH, H20, H40, H64, H200, H250, H252, H300, H302, H700, H702, H1000, H1002, H2000, H4010.

Website: <http://www.hitachi-ies.co.jp/english/products/plc/index.htm>

HMI Setting:

Parameters	Recommended	Options	Notes
PLC type	Hitachi H/EH/EHV Series		
PLC I/F	RS232	RS232, RS485	
Baud rate	19200	9600, 19200, 38400	
Data bits	7	7	
Parity	Even	Even	
Stop bits	1	1	
PLC sta. no.	0	0-255	Does not apply to this protocol.

Online simulator	YES	Broadcast command	NO
Extend address mode	NO		

Device Address:

Bit/Word	Device type	Format	Range	Memo
B	X	HHHHh	0 ~ ffff	External input-bit (X)
B	Y	HHHHh	0 ~ ffff	External output-bit (Y)
B	M	HHHHh	0 ~ ffff	Data area-bit (M)
B	T	HHHHh	0 ~ ffff	Timer (T)
B	R	HHHHh	0 ~ ffff	Internal output (R)
B	L	HHHHh	0 ~ ffff	Link area-bit (L)
W	TC	HH	0 ~ ff	Timer/Counter current value
W	WM	HHHH	0 ~ 270f	Data area-word (M)
W	WX	HHHH	0 ~ 270f	External input-word (X)
W	WY	HHHH	0 ~ 270f	External output-word (Y)
W	WR	HHHH	0 ~ c3ff	Internal output-word (R)
W	WL	HHHH	0 ~ 270f	Link area-word (L)

Wiring Diagram:

WARNING: If your communication cable is not wired exactly as shown in our cable assembly instructions, damage to the HMI or loss of communications can be caused.

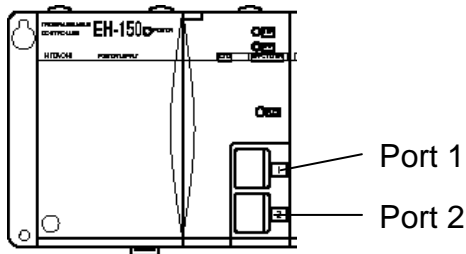

CPU TYPE	Port 1	Port 2
EH-150/CPU 104A	RS-232	RS-232
EH-150/CPU 208A	RS-232	RS-232
EH-150/CPU 308A	RS-232/RS-485	RS-232
EH-150/CPU 316A	RS-232/RS-485	RS-232
EH-150/CPU 448A	RS-232/RS-485	RS-232

Switch Number				
1	OFF	Normal mode		
2	OFF	TRNS0 operation		
3, 4	3	4	Port1 transmission speed	
	ON	ON	4,800 bps	Doesn't support
	OFF	ON	9,600 bps	
	ON	OFF	19,200 bps	Default
	OFF	OFF	38,400 bps	
5	ON	Dedicated port		
6	6	PHL	Port2 transmission speed	
	ON	Low	9,600 bps	
	ON	High	38,400 bps	
	OFF	Low	4,800 bps	Doesn't support
	OFF	High	19,200 bps	Default
7	OFF	(System mode)		Do not turn on.
8	OFF	(System mode)		Do not turn on.

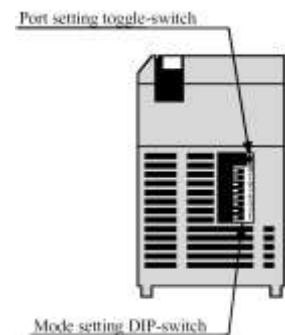

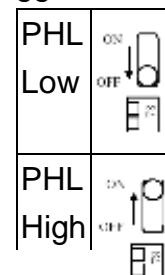

Toggle-Switch







The following represents the view of HMI & PLC.

EH-150 port1/port 2 RS232 / MICRO-EH port1 RS232



eMT3000 series

COM1 RS232 9P D-Sub Female	COM3 RS232 9P D-Sub Female		RS232 8P RJ45 Male
2 RX	8 RX		5 SD
3 TX	7 TX		6 RD
5 GND	5 GND		1 SG
8 CTS			8 RS
			4 PHL
			7 DR
			circuit
			

MT6000/8000 series except MT6050i/MT8050i

COM1 RS232 9P D-Sub Female	COM2 RS232 9P D-Sub Female	COM3 RS232 9P D-Sub Male	RS232 8P RJ45 Male
2 RX	6 RX	8 RX	5 SD
3 TX	4 TX	7 TX	6 RD
5 GND	5 GND	5 GND	1 SG
8 CTS			8 RS
			4 PHL
			7 DR
			circuit
			



MT6050i/MT8050i

COM1 RS232 9P D-Sub Female			RS232 8P RJ45 Male
9 RX			5 SD
6 TX			6 RD
5 GND			1 SG
			8 RS
			4 PHL
			7 DR
			circuit
			



The following represents the view of HMI & PLC.

EH-150 port1 RS485 4W



eMT3000 series

COM1 RS485 4W 9P D-Sub Male			RS485 4W 8P RJ45 Male
1 RX-			5 TX-
2 RX+			4 TX+
3 TX-			6 RX-
4 TX+			7 RX+
5 GND			1 SG
			

MT6000/8000 series except MT6050i/MT8050i

COM1 RS485 4W 9P D-Sub Male			RS485 4W 8P RJ45 Male
1 RX-			5 TX-
2 RX+			4 TX+
3 TX-			6 RX-
4 TX+			7 RX+
5 GND			1 SG
			



MT6050i/MT8050i

COM1 RS485 4W 9P D-Sub Female			RS485 4W 8P RJ45 Male
1 RX-			5 TX-
2 RX+			4 TX+
3 TX-			6 RX-
4 TX+			7 RX+
5 GND			1 SG
			



The following represents the view of HMI & PLC.

EH-150 port1 RS485 2W



eMT3000 series

COM1 RS485 2W 9P D-Sub Male	COM3 RS485 2W 9P D-Sub Male		RS485 2W 8P RJ45 Male	
1 RX-	6 Data-		4 TX+	circuit
			7 RX+	
2 RX+	9 Data+		5 TX-	circuit
			6 RX-	
5 GND	5 GND		1 SG	
				

MT6000/8000 series except MT6050i/MT8050i

COM1 RS485 2W 9P D-Sub Male	COM3 RS485 2W 9P D-Sub Male		RS485 2W 8P RJ45 Male	
1 RX-	6 Data-		4 TX+	circuit
			7 RX+	
2 RX+	9 Data+		5 TX-	circuit
			6 RX-	
5 GND	5 GND		1 SG	
				



MT6050i/MT8050i

COM1 RS485 2W 9P D-Sub Female	COM3 RS485 2W 9P D-Sub Female		RS485 2W 8P RJ45 Male	
1 RX-	7 Data-		4 TX+	circuit
			7 RX+	
2 RX+	8 Data+		5 TX-	circuit
			6 RX-	
5 GND	5 GND		1 SG	
				



The following represents the view of HMI & PLC.

H Series CPU Port RS232

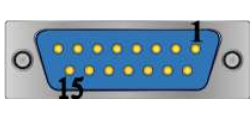
eMT3000 series

COM1 RS232 9P D-Sub Female	COM3 RS232 9P D-Sub Female		RS232 15P D-Sub Male
2 RX	8 RX		2 TXD
3 TX	7 TX		3 RXD
5 GND	5 GND		9 SG
			10 SG
8 CTS			4 RTS
			5 CTS
			7 DSR
			8 PHL
			14 PV12
			

MT6000/8000 series except MT6050i/MT8050i

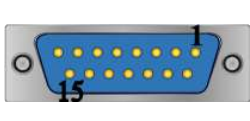
COM1 RS232 9P D-Sub Female	COM2 RS232 9P D-Sub Female	COM3 RS232 9P D-Sub Male	RS232 15P D-Sub Male
2 RX	6 RX	8 RX	2 TXD
3 TX	4 TX	7 TX	3 RXD
5 GND	5 GND	5 GND	9 SG
			10 SG
8 CTS			4 RTS
			5 CTS
			7 DSR
			8 PHL
			14 PV12
			

MT6050i/MT8050i

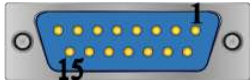
COM1 RS232 9P D-Sub Female			RS232 15P D-Sub Male
9 RX			5 SD
6 TX			6 RD
5 GND			1 SG
			8 RS
			5 CTS
			7 DSR
			8 PHL
			14 PV12
			

Driver Version:

Version	Date	Description
V1.10	Oct/22/2009	Fixed HMI occupies the control right of CPU module.
V1.30	Mar/22/2010	

HUST H4X

Supported Series: HUST CNC Controller H4 Series.

Website: <http://www.hust.com.tw/>

HMI Setting:

Parameters	Recommended	Options	Notes
PLC type	HUST H4X		
PLC I/F	RS-232		CPU port
Baud rate	38400	9600,19200,38400,57600	
Data bits	7		
Parity	Even		
Stop bits	2		
Turn around delay	5		
PLC sta. no.	1		



Device Address:

Bit/Word	Device type	Format	Range	Memo
B	I	DDD	0 ~ 255	Mapping to VM 10800 ~ 10807 (read only)
B	O	DDD	0 ~ 255	Mapping to VM 10808 ~ 10815 (read only)
B	C	DDD	0 ~ 255	Mapping to VM 10816 ~ 10823 (read only)
B	S	DDD	0 ~ 255	Mapping to VM 10824 ~ 10831 (read only)
B	A	DDD	0 ~ 255	Mapping to VM 10832 ~ 10863 (read only)
B	VM_bit	DDDDdd	100 ~ 9999931	Bit address (dd): 00 ~ 31
DW	VM	DDDDD	1 ~ 99999	Please refer to the controller specification for register range.
DW	R	DDD	0 ~ 255	Mapping to VM 10000 ~ 10255 (read only)
DW	Cn	DDD	0 ~ 255	Mapping to VM 10256 ~ 10511 (read only)
DW	Tm	DDD	0 ~ 255	Mapping to VM 10512 ~ 10767 (read only)





Wiring Diagram:

The following represents the view of HMI & PLC.



eMT3000 series

COM1 RS232 9P D-Sub Female	COM3 RS232 9P D-Sub Female		HUST CNC Controller RS232 D-Sub Male
2 RX	8 RX		2 TXD
3 TX	7 TX		3 RXD
5 GND	5 GND		5 GND
			

MT6000/8000 series except MT6050i/MT8050i

COM1 RS232 9P D-Sub Female	COM2 RS232 9P D-Sub Female	COM3 RS232 9P D-Sub Male	HUST CNC Controller RS232 D-Sub Male
2 RX	6 RX	8 RX	2 TXD
3 TX	4 TX	7 TX	3 RXD
5 GND	5 GND	5 GND	5 GND
			

MT6050i/MT8050i

COM1 RS232 9P D-Sub Female			HUST CNC Controller RS232 D-Sub Male
9 RX			2 TXD
6 TX			3 RXD
5 GND			5 GND
			

Driver Version:

Version	Date	Description
V2.01	Sep/29/2009	

IAI X-SEL CONTROLLER

Website: <http://www.iai-robot.co.jp/>

HMI Setting:

Parameters	Recommended	Options	Notes
PLC type	IAI X-SEL CONTROLLER		
PLC I/F	RS232		
Baud rate	9600	9600~19200	
Data bits	7	7 or 8	
Parity	None	Even, Odd, None	
Stop bits	1	1 or 2	
PLC sta. no.	0		

Device Address:

Bit/Word	Device type	Format	Range	Memo
W	Servo_On_Off	H	1 ~ 8	Address 1~8 represent the corresponding axis. Write 1 means ON and 0 means OFF.
W	Servo_Origin	H	1 ~ 8	Address 1~8 represent the corresponding axis. Back to origin.
W	CurrentAxisPos	H	1 ~ 8	For reading current position. The state of current axis is put in RW axis*100. i.e., for the state of axis 2, 2*100=200, so it is in RW200.
W	RunProgram	H	0	Data written indicates which program to run.
W	EndProgram	H	0	Data written indicates which program to stop.
W	PointMove	H	0 ~ 8	Address 1~8 represent the corresponding axis. The data written indicates which point to reach. Put parameters ACC, DEC, SPEED in axis*100+1, axis*100+2 and axis*100+3 respectively.

Bit/Word	Device type	Format	Range	Memo
W	JoggingMove	H	0 ~ 8	Jogging. Address 1~8 represent the corresponding axis. Put parameters ACC, DEC, SPEED and Position in axis*100+11, axis*100+12, axis*100+13 and axis*100+14 respectively.
W	AbsoluteMove	H	0 ~ 8	Jog to the set absolute coordinate. Address 1~8 represent the corresponding axis. Put parameters ACC, DEC, SPEED and Position in axis*100+21, axis*100+22, axis*100+23 and axis*100+24 respectively.
W	PointChange	H	0 ~ 8	To change the value of the point. Address 1~8 represent the corresponding axis. Put parameters ACC, DEC, SPEED and Position in axis*100+31, axis*100+32, axis*100+33 and axis*100+34 respectively.
W	SoftWareReset	H	0	Reset soft ware.



Note: ddd: Decimal, hhh: Hexadecimal, ooo: Octal.

Each model of CPU is different; it is recommended to refer to PLC Manual Device List.





Wiring Diagram:

The following represents the view of HMI & PLC.



eMT3000 series

COM1 RS232 9P D-Sub Female	COM3 RS232 9P D-Sub Female		Host RS232 D-Sub Female
2 RX	8 RX		3 TX
3 TX	7 TX		2 RX
5 GND	5 GND		5 GND
			

MT6000/8000 series except MT6050i/MT8050i

COM1 RS232 9P D-Sub Female	COM2 RS232 9P D-Sub Female	COM3 RS232 9P D-Sub Male	Host RS232 D-Sub Female
2 RX	6 RX	8 RX	3 TX
3 TX	4 TX	7 TX	2 RX
5 GND	5 GND	5 GND	5 GND
			

MT6050i/MT8050i

COM1 RS232 9P D-Sub Female			Host RS232 D-Sub Female
9 RX			3 TX
6 TX			2 RX
5 GND			5 GND
			

Driver Version:

Version	Date	Description
V1.00	Jun/01/2010	Driver released.

IDEC Micro

Supported Series: IDEC Micro3, Micro3C, MicroSmart, OpenNet Controller series.

Website: <http://www.idec.com>

HMI Setting:

Parameters	Recommended	Options	Notes
PLC type	IDEC Micro		
PLC I/F	RS232	RS232, RS485	
Baud rate	9600	9600, 19200	
Data bits	7	7, 8	
Parity	Even	Even, Odd, None	
Stop bits	1	1	
PLC sta. no.	255 (for 1:1 connect)	0-255	255 or same as the PLC setting

Online simulator	YES	
Extend address mode	YES	Do not set the PLC Station No. to 255

PLC Setting:

Communication mode	9600, E, 7, 1 (default), Use Computer Link Protocol
--------------------	---



Device Address:

Bit/Word	Device type	Format	Range	Memo
B	X	DDDDo	0 ~ 20477	Input (I)
B	Y	DDDDo	0 ~ 20477	Output (Q)
B	M	DDDDo	0 ~ 20477	Internal Relay (M)
W	RT	DDDD	0 ~ 9999	Timer (T)
W	RC	DDDD	0 ~ 9999	Counter (C)
W	D	DDDD	0 ~ 9999	Data Register (D)





Wiring Diagram:

The following represents the view of HMI & PLC.



Micro3C, MicroSmart, OpenNet Controller CPU Ladder Port
eMT3000 series

COM1 RS232 9P D-Sub Female	COM3 RS232 9P D-Sub Female		Port1 or Port2 RS232 8P Mini-DIN Male
2 RX	8 RX		3 TXD
3 TX	7 TX		4 RXD
5 GND	5 GND		7 GND
			

MT6000/8000 series except MT6050i/MT8050i



COM1 RS232 9P D-Sub Female	COM2 RS232 9P D-Sub Female	COM3 RS232 9P D-Sub Male	Port1 or Port2 RS232 8P Mini-DIN Male
2 RX	6 RX	8 RX	3 TXD
3 TX	4 TX	7 TX	4 RXD
5 GND	5 GND	5 GND	7 GND
			

MT6050i/MT8050i



COM1 RS232 9P D-Sub Female			Port1 or Port2 RS232 8P Mini-DIN Male
9 RX			3 TXD
6 TX			4 RXD
5 GND			7 GND
			

The following represents the view of HMI & PLC.



 Micro3 CPU Port, MicroSmart with FC4A-PC2 RS485 Communication Adapter
 eMT3000 series

COM1 RS485 2W 9P D-Sub Male	COM3 RS485 2W 9P D-Sub Male		RS485 8P Mini-DIN Male
1 RX-	6 Data-		2 RXD-
2 RX+	9 Data+		1 RXD+
5 GND	5 GND		7 GND
			

MT6000/8000 series except MT6050i/MT8050i

COM1 RS485 2W 9P D-Sub Male	COM3 RS485 2W 9P D-Sub Male		RS485 8P Mini-DIN Male
1 RX-	6 Data-		2 RXD-
2 RX+	9 Data+		1 RXD+
5 GND	5 GND		7 GND
			



MT6050i/MT8050i

COM1 RS485 2W 9P D-Sub Female	COM3 RS485 2W 9P D-Sub Female		RS485 8P Mini-DIN Male
1 RX-	7 Data-		2 RXD-
2 RX+	8 Data+		1 RXD+
5 GND	5 GND		7 GND
			



The following represents the view of HMI & PLC.

Micro3C, OpenNet Controller Data Link Terminals, MicroSmart with FC4A-PC3 RS485 Communication Adapter

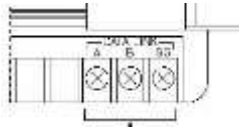

eMT3000 series

COM1 RS485 2W 9P D-Sub Male	COM3 RS485 2W 9P D-Sub Male		Data Link Terminal
1 RX-	6 Data-		A RXD-
2 RX+	9 Data+		B RXD+
5 GND	5 GND		SG GND
			

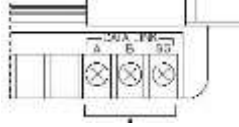
MT6000/8000 series except MT6050i/MT8050i

COM1 RS485 2W 9P D-Sub Male	COM3 RS485 2W 9P D-Sub Male		Data Link Terminal
1 RX-	6 Data-		A RXD-
2 RX+	9 Data+		B RXD+
5 GND	5 GND		SG GND
			

MT6050i/MT8050i

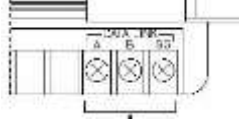
COM1 RS485 2W 9P D-Sub Female	COM3 RS485 2W 9P D-Sub Female		Data Link Terminal
1 RX-	7 Data-		A RXD-
2 RX+	8 Data+		B RXD+
5 GND	5 GND		SG GND
			

Driver Version:

Version	Date	Description
V1.20	Jun/19/2009	

Inovance H2U/H1U

Website: <http://www.inovance.cn/>

HMI Setting:

Parameters	Recommended	Options	Notes
PLC type	Inovance H2U/H1U		
PLC I/F	RS485 4W		
Baud rate	9600	9600~19200	
Data bits	7	7 or 8	
Parity	Even	Even, Odd, None	
Stop bits	1	1 or 2	
PLC sta. no.	0		

Device Address:

Bit/Word	Device type	Format	Range	Memo
B	X	OOO	0 ~ 377	Input Bits
B	Y	OOO	0 ~ 377	Output Bits
B	M	DDDD	0 ~ 7999	Auxiliary Relay
B	T	DDD	0 ~ 255	Timer Relay
B	C	DDD	0 ~ 255	Counter Relay
B	SM	DDDD	8000 ~ 9999	Special Auxiliary Relay
B	D_Bit	DDDDdd	0 ~ 799915	
B	S	DDDD	0 ~ 4095	
W	TV	DDD	0 ~ 255	Timer Memory
W	CV	DDD	0 ~ 199	Counter Memory
W	D	DDDD	0 ~ 7999	Data Registers
DW	CV2	DDD	200 ~ 255	Counter Memory (32bit)
W	SD	DDDD	8000 ~ 9999	Special Data Register



Note: ddd: Decimal, hhh: Hexadecimal, ooo: Octal.

Each model of CPU is different, it is recommended to refer to PLC Manual Device List.



Wiring Diagram:

The following represents the view of HMI & PLC.



eMT3000 series

COM1 RS485 4W 9P D-Sub Male			H2U/H1U RS422 8P Mini-DIN Male
1 RX-			4 TX-
2 RX+			7 TX+
3 TX-			1 RX-
4 TX+			2 RX+
5 GND			3 GND
			

MT6000/8000 series except MT6050i/MT8050i

COM1 RS485 4W 9P D-Sub Male			H2U/H1U RS422 8P Mini-DIN Male
1 RX-			4 TX-
2 RX+			7 TX+
3 TX-			1 RX-
4 TX+			2 RX+
5 GND			3 GND
			

MT6050i/MT8050i

COM1 RS485 4W 9P D-Sub Female			H2U/H1U RS422 8P Mini-DIN Male
1 RX-			4 TX-
2 RX+			7 TX+
3 TX-			1 RX-
4 TX+			2 RX+
5 GND			3 GND
			

Driver Version:

Version	Date	Description
V1.00	May/19/2010	Driver released.

Justfi Controller

Supported Series: Justfi weighing instruments, Industrial Batching Controller supports XK31CB4, XK31CB6.

Website: <http://www.justfi.com>

HMI Setting:

Parameters	Recommended	Options	Notes
PLC type	Justfi controller		
PLC I/F	RS232		
Baud rate	9600	9600, 19200	
Data bits	7	7 or 8	
Parity	Even	Even, Odd, None	
Stop bits	1	1 or 2	
PLC sta. no.	1		



Device Address:

Bit/Word	Device type	Format	Range	Memo
W	Func	DD	0 ~ 99	Read / Write
DW	Func_DW	DD	0 ~ 99	Read / Write
W	RW	H	0	Weight (read only)
W	RF	H	0	Read result (read only)
W	RT	H	0	Read total (read only)
W	RG	H	0	Read prescription group
W	RC	H	0	Circle
W	RB	H	0	Read status (read only)
W	MZ	H	0	Zero (write only)
W	MT	H	0	Tare (write only)
W	CT	H	0	Clear tare (write only)
W	DT	H	0	Clear total (write only)
W	BB	H	0	Start (write only)
W	HB	H	0	Stop (write only)
W	BD	H	0	Discharge (write only)
W	RP1t RP6F	H	0	Read/Write recipe





Wiring Diagram:

The following represents the view of HMI & PLC.



eMT3000 series

COM1 RS232 9P D-Sub Female	COM3 RS232 9P D-Sub Female		CB4 RS232
2 RX	8 RX		TD
3 TX	7 TX		RD
5 GND	5 GND		GND
			

MT6000/8000 series except MT6050i/MT8050i

COM1 RS232 9P D-Sub Female	COM2 RS232 9P D-Sub Female	COM3 RS232 9P D-Sub Male	CB4 RS232
2 RX	6 RX	8 RX	TD
3 TX	4 TX	7 TX	RD
5 GND	5 GND	5 GND	GND
			

MT6050i/MT8050i

COM1 RS232 9P D-Sub Female			CB4 RS232
9 RX			TD
6 TX			RD
5 GND			GND
			

Driver Version:

Version	Date	Description
V1.40	Nov/04/2009	

Kernel sistemi DMX Series

Supported Series: Kernel sistemi DMX 30

Website: <http://www.kernel.modena.it/>

HMI Setting:

Parameters	Recommended	Options	Notes
PLC type	Kernel sistemi DMX Series		
PLC I/F	RS232	RS485	
Baud rate	19200	9600	
Data bits	8		
Parity	None		
Stop bits	1		
PLC sta. no.	1		Must match the PLC port setting



Device Address:

Bit/Word	Device type	Format	Range	Memo
W	D	HHHH	0 ~ ffff	





Wiring Diagram:

The following represents the view of HMI & PLC.



eMT3000 series

COM1 RS232 9P D-Sub Female	COM3 RS232 9P D-Sub Female		DMX30 RS232 9P D-Sub Male
2 RX	8 RX		3 TX
3 TX	7 TX		2 RX
5 GND	5 GND		5 GND
			

MT6000/8000 series except MT6050i/MT8050i

COM1 RS232 9P D-Sub Female	COM2 RS232 9P D-Sub Female	COM3 RS232 9P D-Sub Male	DMX30 RS232 9P D-Sub Male
2 RX	6 RX	8 RX	3 TX
3 TX	4 TX	7 TX	2 RX
5 GND	5 GND	5 GND	5 GND
			

MT6050i/MT8050i

COM1 RS232 9P D-Sub Female			DMX30 RS232 9P D-Sub Male
9 RX			3 TX
6 TX			2 RX
5 GND			5 GND
			

Driver Version:

Version	Date	Description
V1.00	Feb/06/2010	Driver released.

KEYENCE KV-10/16/24/40/80/Visual KV Series

Supported Series: KEYENCE KV series, KV16~80

Website: <http://www.keyence.com/>

HMI Setting:

Parameters	Recommended	Options	Notes
PLC type	KEYENCE KV-10/16/24/40/80/Visual KV Series		
PLC I/F	RS232	RS232	
Baud rate	9600		
Data bits	8		
Parity	Even		
Stop bits	1		
PLC sta. no.	0		

Device Address:

Bit/Word	Device type	Format	Range	Memo
B	RLY	DDDdd0*	0 ~ 655150*	dd:0 ~ 15
B	DM_Bit	DDDDh	0 ~ 65535f	
W	DM	DDDD	0 ~ 65535	
W	TM	DDDD	0 ~ 8999	
W	T	DDDD	0 ~ 9999	
W	T_Curr	DDDD	0 ~ 9999	Timer_Current
W	T_Preset	DDDD	0 ~ 9999	
W	C	DDDD	0 ~ 9999	
W	C_Curr	DDDD	0 ~ 9999	Counter_Current
W	C_Preset	DDDD	0 ~ 9999	

Note:*

If Relay (bit) register is used, please place a zero at the end of the address.



For example, to read Relay (bit) 100, the address is written as "1000".

Wiring Diagram:





The following represents the view of HMI & PLC.

RS232 CPU Port:



eMT3000 series

COM1 RS232 9P D-Sub Female	COM3 RS232 9P D-Sub Female		OP-26486 9P D-Sub Male
2 RX	8 RX		3 TXD
3 TX	7 TX		2 RXD
5 GND	5 GND		5 GND
			

MT6000/8000 series except MT6050i/MT8050i

COM1 RS232 9P D-Sub Female	COM2 RS232 9P D-Sub Female	COM3 RS232 9P D-Sub Male	OP-26486 9P D-Sub Male
2 RX	6 RX	8 RX	3 TXD
3 TX	4 TX	7 TX	2 RXD
5 GND	5 GND	5 GND	5 GND
			



MT6050i/MT8050i

COM1 RS232 9P D-Sub Female			OP-26486 9P D-Sub Male
9 RX			3 TXD
6 TX			2 RXD
5 GND			5 GND
			





The following represents the view of HMI & PLC.

9P D-Sub to 6P RJ11:



eMT3000 series

COM1 RS232 9P D-Sub Female	COM3 RS232 9P D-Sub Female		RS232 6P RJ11 Male
2 RX	8 RX		2 TXD
3 TX	7 TX		4 RXD
5 GND	5 GND		3 GND
			

MT6000/8000 series except MT6050i/MT8050i

COM1 RS232 9P D-Sub Female	COM2 RS232 9P D-Sub Female	COM3 RS232 9P D-Sub Male	RS232 6P RJ11 Male
2 RX	6 RX	8 RX	2 TXD
3 TX	4 TX	7 TX	4 RXD
5 GND	5 GND	5 GND	3 GND
			

MT6050i/MT8050i

COM1 RS232 9P D-Sub Female			RS232 6P RJ11 Male
9 RX			2 TXD
6 TX			4 RXD
5 GND			3 GND
			

Driver Version:

Version	Date	Description
V1.40	Apr/17/2009	

KEYENCE KV-5000 (Ethernet)

Supported series: KV5000, 3000, 1000 series.

Website: <http://www.keyence.com/>

HMI Setting:

Parameters	Recommended	Options	Notes
PLC type	KEYENCE KV-5000 (Ethernet)		
PLC I/F	Ethernet		
Port no.	8501		
PLC sta. no.	0		

Device Address:

Bit/Word	Device type	Format	Range	Memo
B	MR	DDDdd	0 ~ 99915	
B	LR	DDDdd	0 ~ 99915	
B	CR	DDDdd	0 ~ 99915	
B	RLY	DDDdd	0 ~ 99915	
W	DM	DDDDD	0 ~ 65535	
W	TM	DDDD	0 ~ 9999	
W	T	DDDD	0 ~ 9999	
W	T_Curr	DDDD	0 ~ 9999	Timer Current
W	T_Preset	DDDD	0 ~ 9999	Timer Preset
W	C	DDDD	0 ~ 9999	
W	C_Curr	DDDD	0 ~ 9999	
W	C_Preset	DDDD	0 ~ 9999	
W	CM	DDDDD	0 ~ 65535	
W	EM	DDDDD	0 ~ 65535	
W	FM	DDDDD	0 ~ 65535	

Note:

If RLY (bit) register is used, please place a zero at the end of the address.

For example, to read RLY 100, the address is written as "1000".

Wiring Diagram:

Direct connect (crossover cable):

HMI RJ45 Male	Wire Color	Wire Color	PLC RJ45 Male
1 TX+	White/Orange	White/Green	3 RX+
2 TX-	Orange	Green	6 RX-
3 RX+	White/Green	White/Orange	1 TX+
4 BD4+	Blue	Blue	4 BD4+
5 BD4-	White/Blue	White/Blue	5 BD4-
6 RX-	Green	Orange	2 TX-
7 BD3+	White/Brown	White/Brown	7 BD3+
8 BD3-	Brown	Brown	8 BD3-



Through a hub:

HMI RJ45 Male	Wire Color	Wire Color	PLC RJ45 Male
1 TX+	White/Orange	White/Orange	1 TX+
2 TX-	Orange	Orange	2 TX-
3 RX+	White/Green	White/Green	3 RX+
4 BD4+	Blue	Blue	4 BD4+
5 BD4-	White/Blue	White/Blue	5 BD4-
6 RX-	Green	Green	6 RX-
7 BD3+	White/Brown	White/Brown	7 BD3+
8 BD3-	Brown	Brown	8 BD3-



Driver Version:

Version	Date	Description
V1.00	Dec/25/2009	Driver released.

KEYENCE KV-700/1000/3000/5000 Series

Website: <http://www.keyence.com/>

HMI Setting:

Parameters	Recommended	Options	Notes
PLC type	KEYENCE KV-700/1000/3000/5000 Series		
PLC I/F	RS232	RS232	
Baud rate	115200		
Data bits	8		
Parity	Even		
Stop bits	1		
PLC sta. no.	0		

Device Address:

Bit/Word	Device type	Format	Range	Memo
B	MR	DDDdd	0 ~ 99915	
B	LR	DDDdd	0 ~ 99915	
B	CR	DDDdd	0 ~ 99915	
B	RLY	DDDdd	0 ~ 99915	
W	DM	DDDDD	0 ~ 65535	
W	TM	DDDD	0 ~ 9999	
W	T	DDDD	0 ~ 9999	
W	T_Curr	DDDD	0 ~ 9999	Timer_Current
W	T_Preset	DDDD	0 ~ 9999	
W	C	DDDD	0 ~ 9999	
W	C_Curr	DDDD	0 ~ 9999	Counter_Current
W	C_Preset	DDDD	0 ~ 9999	
W	CM	DDDDD	0 ~ 65535	
W	EM	DDDDD	0 ~ 65535	
W	FM	DDDDD	0 ~ 65535	

Note:



If Relay (bit) register is used, please place a zero at the end of the address.

For example, to read Relay (bit) 100, the address is written as "1000".





Wiring Diagram:

The following represents the view of HMI & PLC.



eMT3000 series

COM1 RS232 9P D-Sub Female	COM3 RS232 9P D-Sub Female		OP-26486 9P D-Sub Male
2 RX	8 RX		3 TXD
3 TX	7 TX		2 RXD
5 GND	5 GND		5 GND
			

MT6000/8000 series except MT6050i/MT8050i

COM1 RS232 9P D-Sub Female	COM2 RS232 9P D-Sub Female	COM3 RS232 9P D-Sub Male	OP-26486 9P D-Sub Male
2 RX	6 RX	8 RX	3 TXD
3 TX	4 TX	7 TX	2 RXD
5 GND	5 GND	5 GND	5 GND
			

MT6050i/MT8050i

COM1 RS232 9P D-Sub Female			OP-26486 9P D-Sub Male
9 RX			3 TXD
6 TX			2 RXD
5 GND			5 GND
			

Driver Version:

Version	Date	Description
V2.20	Jul/28/2009	

Korenix 6550

Website: <http://www.korenix.com/>

HMI Setting:

Parameters	Recommended	Options	Notes
PLC type	Korenix 6550		Modbus protocol
PLC I/F	Ethernet		
Port no.	502		
PLC sta. no.		0	

Device Address:

Bit/Word	Device type	Format	Range	Memo
B	1x	DDDDD	1 ~ 65535	
B	0x	DDDDD	1 ~ 65535	
B	3x_Bit	DDDDDdd	100 ~ 6553515	
B	4x_Bit	DDDDDdd	100 ~ 6553515	
B	6x_Bit	DDDDDdd	100 ~ 6553515	
W	3x	DDDDD	1 ~ 65535	
W	4x	DDDDD	1 ~ 65535	
W	5x	DDDDD	1 ~ 65535	
W	6x	DDDDD	1 ~ 65535	

Wiring Diagram:

Direct connect (crossover cable):

HMI RJ45 Male	Wire Color	Wire Color	PLC RJ45 Male
1 TX+	White/Orange	White/Green	3 RX+
2 TX-	Orange	Green	6 RX-
3 RX+	White/Green	White/Orange	1 TX+
4 BD4+	Blue	Blue	4 BD4+
5 BD4-	White/Blue	White/Blue	5 BD4-
6 RX-	Green	Orange	2 TX-
7 BD3+	White/Brown	White/Brown	7 BD3+
8 BD3-	Brown	Brown	8 BD3-



Through a hub:

HMI RJ45 Male	Wire Color	Wire Color	PLC RJ45 Male
1 TX+	White/Orange	White/Orange	1 TX+
2 TX-	Orange	Orange	2 TX-
3 RX+	White/Green	White/Green	3 RX+
4 BD4+	Blue	Blue	4 BD4+
5 BD4-	White/Blue	White/Blue	5 BD4-
6 RX-	Green	Green	6 RX-
7 BD3+	White/Brown	White/Brown	7 BD3+
8 BD3-	Brown	Brown	8 BD3-



Driver Version:

Version	Date	Description
V1.61	Apr/17/2009	

KOYO CLICK

Supported Series: KOYO CLICK PLC series

Website: <http://www.automationdirect.com>

HMI Setting:

Parameters	Recommended	Options	Notes
PLC type	KOYO CLICK		
PLC I/F	RS232		
Baud rate	38400	Com Port1 (fixed)	Reference PLC Specification
Data bits	8	Com Port1 (fixed)	Reference PLC Specification
Parity	Odd	Com Port1 (fixed)	Reference PLC Specification
Stop bits	1	Com Port1 (fixed)	Reference PLC Specification
PLC sta. no.	1	Com Port1 (fixed)	Reference PLC Specification

Device Address:

Bit/Word	Device type	Format	Range	Memo
B	X	Ddd	001 ~ 816	Input Status (Read Only)
B	Y	Ddd	001 ~ 816	Output Status
B	C	DDDD	1 ~ 2000	Control Bit
B	T	DDD	1 ~ 500	Timer Status (Read Only)
B	CT	DDD	1 ~ 250	Counter Status (Read Only)
B	SC	DDDD	1 ~ 1000	System Control Bit (Read Only)
W	DS	DDDD	1 ~ 4500	Data Registers
W	DD	DDDD	1 ~ 1000	Data Registers (Double Word)
W	DH	DDD	1 ~ 500	Data Registers
W	DF	DDD	1 ~ 500	Data Registers (Double Word)
W	XD	D	0 ~ 8	Input Status Registers (Read Only)
W	YD	D	0 ~ 8	Output Status Registers
W	TD	DDD	1 ~ 500	Timer Current Values (Read Only)
W	CTD	DDD	1 ~ 250	Counter Current Values (Double Word/Read Only)
W	SD	DDDD	1 ~ 1000	System Data Registers (Read Only)
W	TXT	DDDD	1 ~ 1000	Text Data Registers

Wiring Diagram:

KOYO CLICK PLC Com Port:

6 pin RJ12 Phone
Type Jack – both ports

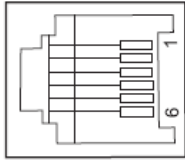



Port 1 Pin Descriptions		
1	0V	Power (-) connection (GND)
2	5V	Power (+) connection
3	RXD	Receive data (RS-232)
4	TXD	Transmit data (RS-232)
5	NC	No connection
6	0V	Power (-) connection (GND)





Port 2 Pin Descriptions		
1	0V	Power (-) connection (GND)
2	5V	Power (+) connection
3	RXD	Receive data (RS-232)
4	TXD	Transmit data (RS-232)
5	RTS	Request to send
6	0V	Power (-) connection (GND)

The following represents the view of HMI & PLC.



Driver eMT3000 series

COM1 RS232 9P D-Sub Female	COM3 RS232 9P D-Sub Female		RS232 6P RJ12 Male
2 RX	8 RX		4 TXD
3 TX	7 TX		3 RXD
5 GND	5 GND		1 GND
			

MT6000/8000 series except MT6050i/MT8050i

COM1 RS232 9P D-Sub Female	COM2 RS232 9P D-Sub Female	COM3 RS232 9P D-Sub Male	RS232 6P RJ12 Male
2 RX	6 RX	8 RX	4 TXD
3 TX	4 TX	7 TX	3 RXD
5 GND	5 GND	5 GND	1 GND
			

MT6050i/MT8050i

COM1 RS232 9P D-Sub Female			RS232 6P RJ12 Male
9 RX			4 TXD
6 TX			3 RXD
5 GND			1 GND
			

Version:

Version	Date	Description
V1.50	Jun/22/2010	

KOYO DIRECT

Supported Series: KOYO DirectLogic series PLC DL05, DL06, DL105, DL205, DL305, and DL405 series.

Website: <http://www.automationdirect.com>

HMI Setting:

Parameters	Recommended	Options	Notes
PLC type	KOYO DIRECT		
PLC I/F	RS232	RS232, RS485	
Baud rate	9600	9600, 19200, 38400	
Data bits	8	7, 8	
Parity	Odd	Even, Odd, None	
Stop bits	1	1	
PLC sta. no.	1	1-90	

PLC Setting:

	<ol style="list-style-type: none"> 1. The PLC must not have a password. 2. PLC must be set for Full Duplex operation. 3. PLC must be set for No Hardware Handshaking. 4. The PLC must be set to use the 'K' Sequence Protocol. 5. Set the mode switch to the TERM mode. 6. When using the D4-440 CPU, the station number must be set to 1.
--	--

Device Address:



Bit/Word	Device type	Format	Range	Memo
B	X	OOOO	0 ~ 4000	Input Bits
B	Y	OOOO	0 ~ 4000	Output Bits
B	C	OOOOO	0 ~ 10000	Control Relays
B	T	OOOO	0 ~ 1000	Timer Status Bits
B	CT	OOOO	0 ~ 1000	Counter Status Bits
B	S	OOOO	0 ~ 2000	
B	SP	OOOO	0 ~ 2000	
B	GX	OOOOO	0 ~ 10000	
B	GY	OOOOO	0 ~ 10000	
W	V	OOOOO	0 ~ 77777	V Memory
W	Timer	OOOO	0 ~ 1000	
W	Counter	OOOO	0 ~ 1000	

Wiring Diagram:





The following represents the view of HMI & PLC.

DL05/DL06/DL105/DL230/DL240/DL250/DL350/DL450 RS232 port



eMT3000 series

COM1 RS232 9P D-Sub Female	COM3 RS232 9P D-Sub Female		KOYO CLICK PLC RS232 6P RJ12 Male
2 RX	8 RX		4 TX
3 TX	7 TX		3 RX
5 GND	5 GND		1 GND
			

MT6000/8000 series except MT6050i/MT8050i

COM1 RS232 9P D-Sub Female	COM2 RS232 9P D-Sub Female	COM3 RS232 9P D-Sub Male	KOYO CLICK PLC RS232 6P RJ12 Male
2 RX	6 RX	8 RX	4 TX
3 TX	4 TX	7 TX	3 RX
5 GND	5 GND	5 GND	1 GND
			



MT6050i/MT8050i

COM1 RS232 9P D-Sub Female			KOYO CLICK PLC RS232 6P RJ12 Male
9 RX			4 TX
6 TX			3 RX
5 GND			1 GND
			





The following represents the view of HMI & PLC.

CPU unit: DL06/DL250 CPU Port2 RS232



eMT3000 series

COM1 RS232 9P D-Sub Female	COM3 RS232 9P D-Sub Female		RS232 Port2 15P D-Sub Male
2 RX	8 RX		2 TX
3 TX	7 TX		3 RX
5 GND	5 GND		7 GND
			4 RTC
			5 CTS
			circuit
			

MT6000/8000 series except MT6050i/MT8050i

COM1 RS232 9P D-Sub Female	COM2 RS232 9P D-Sub Female	COM3 RS232 9P D-Sub Male	RS232 Port2 15P D-Sub Male
2 RX	6 RX	8 RX	2 TX
3 TX	4 TX	7 TX	3 RX
5 GND	5 GND	5 GND	7 GND
			4 RTC
			5 CTS
			circuit
			



MT6050i/MT8050i

COM1 RS232 9P D-Sub Female			RS232 Port2 15P D-Sub Male
9 RX			2 TX
6 TX			3 RX
5 GND			7 GND
			4 RTC
			5 CTS
			circuit
			



The following represents the view of HMI & PLC.

CPU unit: DL06/DL250 CPU Port2 RS422



eMT3000 series

COM1 RS485 4W 9P D-Sub Male			RS422 Port2 15P D-Sub Male
1 RX-			10 TX-
2 RX+			9 TX+
3 TX-			6 RX-
4 TX+			13 RX+
5 GND			7 GND
			11 RTS+
			14 CTS+
			Circuit
			12 RTS-
			15 CTS-
			Circuit
			

MT6000/8000 series except MT6050i/MT8050i

COM1 RS485 4W 9P D-Sub Male			RS422 Port2 15P D-Sub Male
1 RX-			10 TX-
2 RX+			9 TX+
3 TX-			6 RX-
4 TX+			13 RX+
5 GND			7 GND
			11 RTS+
			14 CTS+
			Circuit
			12 RTS-
			15 CTS-
			Circuit
			

MT6050i/MT8050i



COM1 RS485 4W 9P D-Sub Female			RS422 Port2 15P D-Sub Male
1 RX-			10 TX-
2 RX+			9 TX+
3 TX-			6 RX-
4 TX+			13 RX+
5 GND			7 GND
			11 RTS+
			14 CTS+
			Circuit
			12 RTS-
			15 CTS-
			Circuit
			

Note: DL06/DL250 CPU Port2 include RS232 and RS422



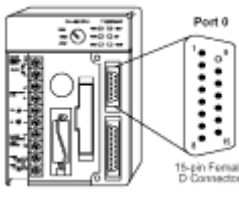

The following represents the view of HMI & PLC.

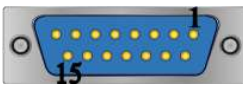
DL430/DL440/DL450 CPU unit Port0 RS232

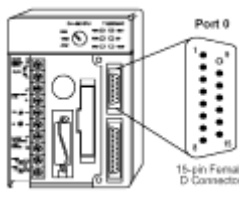

eMT3000 series

COM1 RS232 9P D-Sub Female	COM3 RS232 9P D-Sub Female		RS232 Port0 15P D-Sub Male	
2 RX	8 RX		2 TX	
3 TX	7 TX		3 RX	
5 GND	5 GND		13 GND	
			1 YOP	circuit
			7 CTS	
			2 YOM	
			4 ONLINE	circuit
14 GND				
				

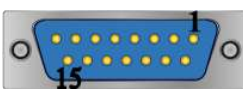
MT6000/8000 series except MT6050i/MT8050i



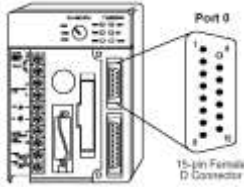

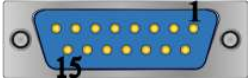
COM1 RS232 9P D-Sub Female	COM2 RS232 9P D-Sub Female	COM3 RS232 9P D-Sub Male	RS232 Port0 15P D-Sub Male	
2 RX	6 RX	8 RX	2 TX	
3 TX	4 TX	7 TX	3 RX	
5 GND	5 GND	5 GND	13 GND	
			1 YOP	circuit
			7 CTS	
			2 YOM	
			4 ONLINE	circuit
14 GND				
				

MT6050i/MT8050i



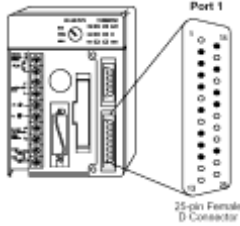

COM1 RS232 9P D-Sub Female			RS232 Port0 15P D-Sub Male	
9 RX			2 TX	
6 TX			3 RX	
5 GND			13 GND	
			1 YOP	
			7 CTS	circuit
			2 YOM	
			4 ONLINE	circuit
14 GND				
				

The following represents the view of HMI & PLC.

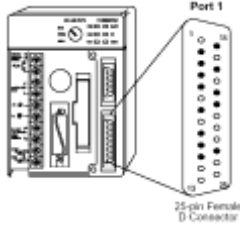

CPU unit: DL430/DL440/DL450 CPU unit Port1 & DL350 CPU unit Port2 RS232
eMT3000 series

COM1 RS232 9P D-Sub Female	COM3 RS232 9P D-Sub Female		RS232 Port1 25P D-Sub Male	
2 RX	RX		2 TX	
3 TX	7 TX		3 RX	
5 GND	5 GND		7 GND	
			4 RTC	
			5 CTS	Circuit
				

MT6000/8000 series except MT6050i/MT8050i

COM1 RS232 9P D-Sub Female	COM2 RS232 9P D-Sub Female	COM3 RS232 9P D-Sub Male	RS232 Port1 25P D-Sub Male	
2 RX	6 RX	8 RX	2 TX	
3 TX	4 TX	7 TX	3 RX	
5 GND	5 GND	5 GND	7 GND	
			4 RTC	Circuit
			5 CTS	
				

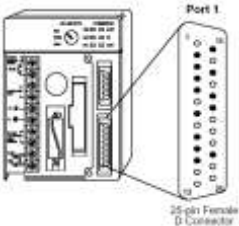

MT6050i/MT8050i

COM1 RS232 9P D-Sub Female			RS232 Port1 25P D-Sub Male	
9 RX			2 TX	
6 TX			3 RX	
5 GND			7 GND	
			4 RTC	Circuit
			5 CTS	
				



The following represents the view of HMI & PLC.

CPU unit: DL430/DL440/DL450 CPU unit Port1 & DL350 CPU unit Port2 RS422



eMT3000 series

COM1 RS485 4W 9P D-Sub Male			RS422 Port 25P D-Sub Male
1 RX-			16 TX-
2 RX+			14 TX+
3 TX-			10 RX-
4 TX+			9 RX+
5 GND			7 GND
			19 RTS+
			11 CTS+
			Circuit
			18 RTS-
			23 CTS-
			Circuit
			

MT6000/8000 series except MT6050i/MT8050i

COM1 RS485 4W 9P D-Sub Male			RS422 Port 25P D-Sub Male
1 RX-			16 TX-
2 RX+			14 TX+
3 TX-			10 RX-
4 TX+			9 RX+
5 GND			7 GND
			19 RTS+
			11 CTS+
			Circuit
			18 RTS-
			23 CTS-
			Circuit
			



MT6050i/MT8050i

COM1 RS485 4W 9P D-Sub Female			RS422 Port 25P D-Sub Male
1 RX-			16 TX-
2 RX+			14 TX+
3 TX-			10 RX-
4 TX+			9 RX+
5 GND			7 GND
			19 RTS+
			11 CTS+
			18 RTS-
			23 CTS-
			Circuit
			Circuit
			



The following represents the view of HMI & PLC.

CPU unit: DL450 CPU unit Port3 RS422



eMT3000 series

COM1 RS485 4W 9P D-Sub Male			RS422 Port3 25P D-Sub Male
1 RX-			13 TX-
2 RX+			12 TX+
3 TX-			25 RX-
4 TX+			24 RX+
5 GND			7 GND
			

MT6000/8000 series except MT6050i/MT8050i

COM1 RS485 4W 9P D-Sub Male			RS422 Port3 25P D-Sub Male
1 RX-			13 TX-
2 RX+			12 TX+
3 TX-			25 RX-
4 TX+			24 RX+
5 GND			7 GND
			



MT6050i/MT8050i

COM1 RS485 4W 9P D-Sub Female			RS422 Port3 25P D-Sub Male
1 RX-			13 TX-
2 RX+			12 TX+
3 TX-			25 RX-
4 TX+			24 RX+
5 GND			7 GND
			





The following represents the view of HMI & PLC.

Communication unit: DL205 series D2-DCM and DL405 series D4-DCM RS232



eMT3000 series

COM1 RS232 9P D-Sub Female	COM3 RS232 9P D-Sub Female		RS232 Port 25P D-Sub Male
2 RX	8 RX		2 TX
3 TX	7 TX		3 RX
5 GND	5 GND		7 GND
			4 RTC
			5 CTS
			circuit
			

MT6000/8000 series except MT6050i/MT8050i

COM1 RS232 9P D-Sub Female	COM2 RS232 9P D-Sub Female	COM3 RS232 9P D-Sub Male	RS232 Port 25P D-Sub Male
2 RX	6 RX	8 RX	2 TX
3 TX	4 TX	7 TX	3 RX
5 GND	5 GND	5 GND	7 GND
			4 RTC
			5 CTS
			circuit
			

MT6050i/MT8050i

COM1 RS232 9P D-Sub Female			RS232 Port 25P D-Sub Male
9 RX			2 TX
6 TX			3 RX
5 GND			7 GND
			4 RTC
			5 CTS
			circuit
			

Driver Version:

Version	Date	Description
V1.30	Nov/08/2010	

KOYO Ethernet

Supported Series: KOYO DirectLogic series, model H0-ECOM100, H2-ECOM100.

Website: <http://www.automationdirect.com>

HMI Setting:

Parameters	Recommended	Options	Notes
PLC type	KOYO Ethernet		
PLC I/F	Ethernet		UDP/IP
Port no.	28784		
PLC sta. no.	No need to set station no.	0	

Device Address:

Bit/Word	Device type	Format	Range	Memo
B	GX	OOOO	0 ~ 3777	Global I/O
B	X	OOOO	0 ~ 1777	Real Word Inputs
B	SP	OOOO	0 ~ 1777	Special Purpose Relays
B	GY	OOOO	0 ~ 3777	More Global I/O
B	Y	OOOO	0 ~ 1777	Real Word Outputs
B	C	OOOO	0 ~ 3777	Control Relays
B	S	OOOO	0 ~ 1777	Stage Status Bits
B	T	OOO	0 ~ 377	Timer Status Bits
B	CT	OOO	0 ~ 377	Counter Status Bits
W	V	OOOOO	0 ~ 41237	V-memory
W	CCM_32	HHH	1 ~ 200	GX, X, SP
W	CCM_33	HHH	1 ~ 340	GY, Y, C, S, T, CT
W	CCM_31	HHHH	1 ~ 42a0	V

ddd:Decimal, hhh:Hexadecimal, ooo:Octal

The mapping of CCM32, CCM33, and CCM31 with other addresses.

Device type	Range	Device type	Range
CCM_31	1~42A0	V	0~41237
CCM_32	1~FF	GX	0~3777
CCM_32	101~17F	X	0~1777
CCM_32	181~1FF	SP	0~1777
CCM_33	1~FF	GY	0~3777
CCM_33	101~17F	Y	0~1777
CCM_33	181~27F	C	0~3777
CCM_33	281~2FF	S	0~1777
CCM_33	301~31F	T	0~377
CCM_33	321~33F	CT	0~377

Wiring Diagram:

Direct connect (crossover cable):

HMI RJ45 Male	Wire Color	Wire Color	PLC RJ45 Male
1 TX+	White/Orange	White/Green	3 RX+
2 TX-	Orange	Green	6 RX-
3 RX+	White/Green	White/Orange	1 TX+
4 BD4+	Blue	Blue	4 BD4+
5 BD4-	White/Blue	White/Blue	5 BD4-
6 RX-	Green	Orange	2 TX-
7 BD3+	White/Brown	White/Brown	7 BD3+
8 BD3-	Brown	Brown	8 BD3-



Through a hub:

HMI RJ45 Male	Wire Color	Wire Color	PLC RJ45 Male
1 TX+	White/Orange	White/Orange	1 TX+
2 TX-	Orange	Orange	2 TX-
3 RX+	White/Green	White/Green	3 RX+
4 BD4+	Blue	Blue	4 BD4+
5 BD4-	White/Blue	White/Blue	5 BD4-
6 RX-	Green	Green	6 RX-
7 BD3+	White/Brown	White/Brown	7 BD3+
8 BD3-	Brown	Brown	8 BD3-



Driver Version:

Version	Date	Description
V1.10	Jul/03/2009	

Lenze

Supported Series: PLC Model No.: 9300/8200 series, and EPL10200

Pass-through 2102IB fieldbus module: RS485 (LECOM B)

Website: <http://www.lenze.de>

HMI Setting:

Parameters	Recommended	Options	Notes
PLC type	Lenze		
PLC I/F	RS232		
Baud rate	9600	9600, 19200	
Data bits	7	7,8	
Parity	None	Even, Odd, None	
Stop bits	1	1, 2	
PLC sta. no.	1	0-255	

PLC Setting:

Communication mode	Same as the MT500 setting
--------------------	---------------------------



Device Address:

Bit/Word	Device type	Format	Range	Memo
B	CNB	DDDDdd	0 ~ 999915	Subcode not supported. Can only read/write CNI Word Type.
B	CB	DDDDddxx	0 ~ 81920015	Subcode supported. Can only read/write CI Word Type.
W	CI	DDDDdd	0 ~ 819200	Subcode supported. Integer
W	CD	DDDDdd	0 ~ 819200	Subcode supported. DWord
W	CF	DDDDdd	0 ~ 819200	Subcode supported. DWord (float point)
W	CNI	DDDD	0 ~ 9999	Subcode not supported. Integer
W	CND	DDDD	0 ~ 9999	Subcode not supported. DWord
W	CNF	DDDD	0 ~ 9999	Subcode not supported. DWord (float point)



Wiring Diagram:

The following represents the view of HMI & PLC.



Lenze 2102IB LECOM-B RS485 plug-in terminal 4-pole
eMT3000 series

COM1 RS485 2W 9P D-Sub Male	COM3 RS485 2W 9P D-Sub Male		RS485 terminal
1 RX-	6 Data-		72 T/R (A)
2 RX+	9 Data+		71 T/R (B)
5 GND	5 GND		
			

MT6000/8000 series except MT6050i/MT8050i

COM1 RS485 2W 9P D-Sub Male	COM3 RS485 2W 9P D-Sub Male		RS485 terminal
1 RX-	6 Data-		72 T/R (A)
2 RX+	9 Data+		71 T/R (B)
5 GND	5 GND		
			

MT6050i/MT8050i

COM1 RS485 2W 9P D-Sub Female	COM3 RS485 2W 9P D-Sub Female		RS485 terminal
1 RX-	7 Data-		72 T/R (A)
2 RX+	8 Data+		71 T/R (B)
5 GND	5 GND		
			

Driver Version:

Version	Date	Description
V1.20	Sep/6/2011	

LingYan BMS

Website: http://www.lyeda.com/Project_file/bms01.htm

HMI Setting:

Parameters	Recommended	Options	Notes
PLC type	LingYan BMS		
PLC I/F	RS232		
Baud rate	9600		
Data bits	8		
Parity	None		
Stop bits	1		
PLC sta. no.	0		



Device Address:

Bit/Word	Device type	Format	Range	Memo
W	Battery_Unit	D	0 -	
W	Insulator_Unit	D	0	
W	Switch_Unit	D	0	



Wiring Diagram:

The following represents the view of HMI & PLC.

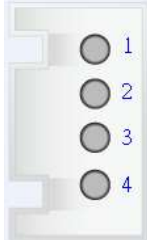
eMT3000 series

COM1 RS232 9P D-Sub Female	COM3 RS232 9P D-Sub Female		RS232 4P Terminal
2 RX	8 RX		1 TXD
3 TX	7 TX		3 RXD
5 GND	5 GND		4 GND
			

MT6000/8000 series except MT6050i/MT8050i

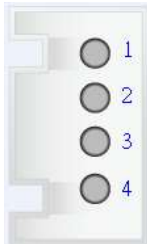
COM1 RS232 9P D-Sub Female	COM2 RS232 9P D-Sub Female	COM3 RS232 9P D-Sub Male	RS232 4P Terminal
2 RX	6 RX	8 RX	1 TXD
3 TX	4 TX	7 TX	3 RXD
5 GND	5 GND	5 GND	4 GND
			

MT6050i/MT8050i

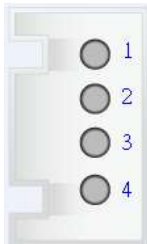
COM1 RS232 9P D-Sub Female			RS232 4P Terminal
9 RX			1 TXD
6 TX			3 RXD
5 GND			4 GND
			

Driver Version:

Version	Date	Description
V1.10	Nov/12/2009	

LIYAN EX series

Supported Series: LIYAN PLC Ex/Ex1s/Ex1n/Ex2n series

Website: <http://www.liyanplc.com/>

HMI Setting:

Parameters	Recommended	Options	Notes
PLC type	Mitsubishi FX0s/FX0n/FX1s/FX1n/FX2		
PLC I/F	RS232	RS232	
Baud rate	9600	9600~115200	
Data bits	7	7,8	
Parity	Even	Even, Odd, None	
Stop bits	1	1,2	
PLC sta. no.	0	0-255	Must match the PLC port setting.

Device Address:



Bit/Word	Device type	Format	Range	Memo
B	X	ooo	0 ~ 377	Input Relay
B	Y	ooo	0 ~ 377	Output Relay
B	M	ddd	0 ~ 9999	Internal Bit Memory
B	T	ddd	0 ~ 255	Timer Bit Memory
B	C	ddd	0 ~ 255	Counter Bit Memory
W	TV	ddd	0 ~ 255	Timer Register
W	CV	ddd	0 ~ 199	Counter Register
W	D	ddd	0 ~ 9999	Data Register
W	CV2	ddd	200 ~ 255	Counter Register (Double Word)
W	SD	ddd	8000 ~ 9999	Special Data Register

Wiring Diagram:





The following represents the view of HMI & PLC.

9P D-Sub to 8P Mini-DIN: Ex, Ex1s, Ex1n, Ex2n series



eMT3000 series

COM1 RS232 9P D-Sub Female	COM3 RS232 9P D-Sub Female		RS232 8P Mini-DIN Male
2 RX	8 RX		2 TXD
3 TX	7 TX		7 RXD
5 GND	5 GND		6 GND
			

MT6000/8000 series except MT6050i/MT8050i

COM1 RS232 9P D-Sub Female	COM2 RS232 9P D-Sub Female	COM3 RS232 9P D-Sub Male	RS232 8P Mini-DIN Male
2 RX	6 RX	8 RX	2 TXD
3 TX	4 TX	7 TX	7 RXD
5 GND	5 GND	5 GND	6 GND
			

MT6050i/MT8050i

COM1 RS232 9P D-Sub Female			RS232 8P Mini-DIN Male
9 RX			2 TXD
6 TX			7 RXD
5 GND			6 GND
			

Driver Version:

Version	Date	Description
V1.20	Oct/26/2011	

LoXin

Website: <http://www.loxin-china.com>

HMI Setting:

Parameters	Recommended	Options	Notes
PLC type	LoXin		
PLC I/F	RS-485 2W		
Baud rate	9600		
Data bits	8		
Parity	Odd		
Stop bits	1		
PLC sta. no.	0		



Device Address:

Bit/Word	Device type	Format	Range	Memo
W	Battery_Unit	D	0	
W	Insulator_Unit	D	0	
W	Switch_Unit	D	0	



Wiring Diagram:

The following represents the view of HMI & PLC.



eMT3000 series

COM1 RS485 2W 9P D-Sub Male	COM3 RS485 2W 9P D-Sub Male		RS485 terminal
1 RX-	6 Data-		D-
2 RX+	9 Data+		D+
5 GND	5 GND		
			

MT6000/8000 series except MT6050i/MT8050i

COM1 RS485 2W 9P D-Sub Male	COM3 RS485 2W 9P D-Sub Male		RS485 terminal
1 RX-	6 Data-		D-
2 RX+	9 Data+		D+
5 GND	5 GND		
			

MT6050i/MT8050i

COM1 RS485 2W 9P D-Sub Female	COM3 RS485 2W 9P D-Sub Female		RS485 terminal
1 RX-	7 Data-		D-
2 RX+	8 Data+		D+
5 GND	5 GND		
			

Driver Version:

Version	Date	Description
V1.00	Oct/16/2008	

LS GLOFA Cnet

Supported Series: LS GLOFA GM6/GM7 CPU port. G7L-CUEB / G6L-CUEB / G4L-CUEA / G3L-CUEA Cnet module

Website: <http://www.lgis.com/>

HMI Setting:

Parameters	Recommended	Options	Notes
PLC type	LS GLOFA Cnet		
PLC I/F	RS232	RS232/RS485 2W/4W	
Baud rate	9600	9600~115200	
Data bits	8	7, 8	
Parity	None	Even, Odd, None	
Stop bits	1	1	
PLC sta. no.	0	0~31	

PLC Setting:

Communication mode	9600,N,8,1 (default), Cnet protocol
Communication module	Applicable mode: 1 dedicated communication

Device Address:



Bit/Word	Device type	Format	Range	Memo
B	MX	DDDDD	0 ~ 32767	Internal Relay
B	IX	ddDdd	0 ~ 63763	Input
B	QX	ddDdd	0 ~ 63763	Output
W	MW	DDDDD	0 ~ 32767	Data Register
DW	MD	DDDDD	0 ~ 16383	Double Word

Wiring Diagram:





The following represents the view of HMI & PLC.

9P D-Sub to 9P D-Sub:



eMT3000 series

COM1 RS232 9P D-Sub Female	COM3 RS232 9P D-Sub Female		RS232 9P D-Sub Male
2 RX	8 RX		7 TXD
3 TX	7 TX		4 RXD
5 GND	5 GND		5 GND
			

MT6000/8000 series except MT6050i/MT8050i

COM1 RS232 9P D-Sub Female	COM2 RS232 9P D-Sub Female	COM3 RS232 9P D-Sub Male	RS232 9P D-Sub Male
2 RX	6 RX	8 RX	7 TXD
3 TX	4 TX	7 TX	4 RXD
5 GND	5 GND	5 GND	5 GND
			



MT6050i/MT8050i

COM1 RS232 9P D-Sub Female			RS232 9P D-Sub Male
9 RX			7 TXD
6 TX			4 RXD
5 GND			5 GND
			





The following represents the view of HMI & PLC.

9P D-Sub to 9P D-Sub: Communication Module (G7L-CUEB / G6L-CUEB / G4L-CUEA / G3L-CUEA Cnet RS232)



eMT3000 series

COM1 RS232 9P D-Sub Female	COM3 RS232 9P D-Sub Female		RS232 9P D-Sub Male
2 RX	8 RX		3 TXD
3 TX	7 TX		2 RXD
5 GND	5 GND		5 GND
			1 CD
			7 RTS
			8 CTS
			4 DTR
			6 DSR
			circuit
			circuit
			

MT6000/8000 series except MT6050i/MT8050i



COM1 RS232 9P D-Sub Female	COM2 RS232 9P D-Sub Female	COM3 RS232 9P D-Sub Male	RS232 9P D-Sub Male
2 RX	6 RX	8 RX	3 TXD
3 TX	4 TX	7 TX	2 RXD
5 GND	5 GND	5 GND	5 GND
			1 CD
			7 RTS
			8 CTS
			4 DTR
			6 DSR
			circuit
			circuit
			

MT6050i/MT8050i



COM1 RS232 9P D-Sub Female			RS232 9P D-Sub Male
9 RX			3 TXD
6 TX			2 RXD
5 GND			5 GND
			1 CD
			7 RTS
			8 CTS
			4 DTR
			6 DSR
			circuit
			circuit
			

The following represents the view of HMI & PLC.



Communication Module (G7L-CUEC / G6L-CUEC / G4L-CUEA / G3L-CUEA Cnet RS422)
eMT3000 series

COM1 RS485 4W 9P D-Sub Male			RS422 terminal
1 RX-			SDB
2 RX+			SDA
3 TX-			RDB
4 TX+			RDA
5 GND			GND
			

MT6000/8000 series except MT6050i/MT8050i

COM1 RS485 4W 9P D-Sub Male			RS422 terminal
1 RX-			SDB
2 RX+			SDA
3 TX-			RDB
4 TX+			RDA
5 GND			GND
			

MT6050i/MT8050i

COM1 RS485 4W 9P D-Sub Female			RS422 terminal
1 RX-			SDB
2 RX+			SDA
3 TX-			RDB
4 TX+			RDA
5 GND			GND
			

Driver Version:

Version	Date	Description
V1.80	Jun/08/2010	

LS GLOFA FEnet (Ethernet)

Website: <http://www.lgis.com/>

HMI Setting:

Parameters	Recommended	Options	Notes
PLC type	LS GLOFA FEnet (Ethernet)		
PLC I/F	Ethernet		
Port no.	2004		
PLC sta. no.	0	0~31	

Device Address:

Bit/Word	Device type	Format	Range	Memo
B	MX	DDDDDD	0 ~ 131056	Internal Relay
B	IX	ddDdd	0 ~ 63763	Input
B	QX	ddDdd	0 ~ 63763	Output
W	MW	DDDD	0 ~ 8191	Data Register
DW	MD	DDDD	0 ~ 4095	Double Word

Wiring Diagram:

Direct connect (crossover cable):

HMI RJ45 Male	Wire Color	Wire Color	PLC RJ45 Male
1 TX+	White/Orange	White/Green	3 RX+
2 TX-	Orange	Green	6 RX-
3 RX+	White/Green	White/Orange	1 TX+
4 BD4+	Blue	Blue	4 BD4+
5 BD4-	White/Blue	White/Blue	5 BD4-
6 RX-	Green	Orange	2 TX-
7 BD3+	White/Brown	White/Brown	7 BD3+
8 BD3-	Brown	Brown	8 BD3-



Through a hub:

HMI RJ45 Male	Wire Color	Wire Color	PLC RJ45 Male
1 TX+	White/Orange	White/Orange	1 TX+
2 TX-	Orange	Orange	2 TX-
3 RX+	White/Green	White/Green	3 RX+
4 BD4+	Blue	Blue	4 BD4+
5 BD4-	White/Blue	White/Blue	5 BD4-
6 RX-	Green	Green	6 RX-
7 BD3+	White/Brown	White/Brown	7 BD3+
8 BD3-	Brown	Brown	8 BD3-



Driver Version:

Version	Date	Description
V1.00	Apr/02/2009	Driver released.

LS GLOFA GM3467 (LOADER)

Supported Series: LS GLOFA series GM3, GM4, GM6, GM7 CPU port.

Website: <http://www.lgis.com/>

HMI Setting:

Parameters	Recommended	Options	Notes
PLC type	LS GLOFA GM3467 (LOADER)		
PLC I/F	RS232		
Baud rate	38400		
Data bits	8		
Parity	None		
Stop bits	1		
PLC sta. no.	1		



Device Address:

Bit/Word	Device type	Format	Range	Memo
B	MX	DDDDDD	0 ~ 524272	
B	IX	ddDdd	0 ~ 63763	00.0.0 ~ 63.7.63 (dd.D.dd)
B	QX	ddDdd	0 ~ 63763	00.0.0 ~ 63.7.63 (dd.D.dd)
W	IW	HHH	0 ~ 273	
W	QW	HHH	0 ~ 273	
W	MW	DDDDD	0 ~ 32767	
W	MD	DDDDD	0 ~ 16383	





Wiring Diagram:

The following represents the view of HMI & PLC.



eMT3000 series

COM1 RS232 9P D-Sub Female	COM3 RS232 9P D-Sub Female		LS GLOFA series RS232 9P D-Sub Male
2 RX	8 RX		3 TD
3 TX	7 TX		2 RD
5 GND	5 GND		5 GND
			

MT6000/8000 series except MT6050i/MT8050i

COM1 RS232 9P D-Sub Female	COM2 RS232 9P D-Sub Female	COM3 RS232 9P D-Sub Male	LS GLOFA series RS232 9P D-Sub Male
2 RX	6 RX	8 RX	3 TD
3 TX	4 TX	7 TX	2 RD
5 GND	5 GND	5 GND	5 GND
			

MT6050i/MT8050i

COM1 RS232 9P D-Sub Female			LS GLOFA series RS232 9P D-Sub Male
9 RX			3 TD
6 TX			2 RD
5 GND			5 GND
			

Driver Version:

Version	Date	Description
V1.30	Mar/08/2010	

LS MASTER-K Cnet

Supported Series: LS MASTER-K series: K80S, K200S, K300S, and K1000S

Website: <http://www.lgis.com/>

HMI Setting:

Parameters	Recommended	Options	Notes
PLC type	LS MASTER-K Cnet		
PLC I/F	RS232	RS232/RS485	
Baud rate	38400	9600, 19200, 38400	
Data bits	8	8	
Parity	None	Even, Odd, None	
Stop bits	1	1	
PLC sta. no.	0	0-31	Must match the PLC port setting.

Online simulator	YES
------------------	-----



Device Address:

Bit/Word	Device type	Format	Range	Memo
B	P	DDDh	0 ~ 255f	I/O Relay (P)
B	K	DDDh	0 ~ 255f	Keep Relay (K)
B	M	DDDh	0 ~ 255f	Auxiliary Relay (M)
B	L	DDDh	0 ~ 255f	Link Relay (L)
B	F	DDDh	0 ~ 255f	Special Relay (F)
B	D_bit	DDDDh	0 ~ 9999f	D_bit
W	TV	DDD	0 ~ 255	Timer Present Value
W	CV	DDD	0 ~ 255	Counter Present Value
W	D	DDDD	0 ~ 9999	Data Register (D)
W	M_word	DDD	0 ~ 255	Word type for M
W	L_word	DDD	0 ~ 255	Word type for L
W	F_word	DDD	0 ~ 255	Word type for F





Wiring Diagram:

The following represents the view of HMI & PLC.



eMT3000 series

COM1 RS232 9P D-Sub Female	COM3 RS232 9P D-Sub Female		CPU Port Cnet I/F RS232 9P D-Sub Male
2 RX	8 RX		7 TX
3 TX	7 TX		4 RX
5 GND	5 GND		5 GND
			

MT6000/8000 series except MT6050i/MT8050i

COM1 RS232 9P D-Sub Female	COM2 RS232 9P D-Sub Female	COM3 RS232 9P D-Sub Male	CPU Port Cnet I/F RS232 9P D-Sub Male
2 RX	6 RX	8 RX	7 TX
3 TX	4 TX	7 TX	4 RX
5 GND	5 GND	5 GND	5 GND
			

MT6050i/MT8050i

COM1 RS232 9P D-Sub Female			CPU Port Cnet I/F RS232 9P D-Sub Male
9 RX			7 TX
6 TX			4 RX
5 GND			5 GND
			

If connected with Cnet module, please refer to Cnet module document.

Driver Version:

Version	Date	Description
V1.00	Apr/19/2010	Driver released.
V1.10	May/11/2011	Added registers: D_bit, M_word, F_word, L_word

LS MASTER-K CPU Direct

Supported Series: LS MASTER-K series: K80S, K120S, K200S, K300S, K1000S, K7M.

Website: <http://www.lgis.com/>

HMI Setting:

Parameters	Recommended	Options	Notes
PLC type	LG MASTER-K CPU Direct		
PLC I/F	RS232	RS232/RS485	
Baud rate	38400	9600, 19200, 38400	
Data bits	8	8	
Parity	None	Even, Odd, None	
Stop bits	1	1	
PLC sta. no.	0	0-31	Must match the PLC port setting.

Online simulator	YES
------------------	-----



Device Address:

Bit/Word	Device type	Format	Range	Memo
B	P	DDDh	0 ~ 255f	I/O Relay (P)
B	K	DDDh	0 ~ 255f	Keep Relay (K)
B	M	DDDh	0 ~ 255f	Auxiliary Relay (M)
B	L	DDDh	0 ~ 255f	Link Relay (L)
B	F	DDDh	0 ~ 255f	Special Relay (F)
B	D_bit	DDDDh	0 ~ 9999f	D_bit
W	TV	DDD	0 ~ 255	Timer Present Value
W	CV	DDD	0 ~ 255	Counter Present Value
W	D	DDDD	0 ~ 9999	Data Register (D)
W	M_word	DDD	0 ~ 255	Word type for M
W	L_word	DDD	0 ~ 255	Word type for L
W	F_word	DDD	0 ~ 255	Word type for F





Wiring Diagram:

The following represents the view of HMI & PLC.



eMT3000 series

COM1 RS232 9P D-Sub Female	COM3 RS232 9P D-Sub Female		RS232 9P D-Sub Male
2 RX	8 RX		3 TX
3 TX	7 TX		2 RX
5 GND	5 GND		5 GND
			

MT6000/8000 series except MT6050i/MT8050i

COM1 RS232 9P D-Sub Female	COM2 RS232 9P D-Sub Female	COM3 RS232 9P D-Sub Male	RS232 9P D-Sub Male
2 RX	6 RX	8 RX	3 TX
3 TX	4 TX	7 TX	2 RX
5 GND	5 GND	5 GND	5 GND
			

MT6050i/MT8050i

COM1 RS232 9P D-Sub Female			RS232 9P D-Sub Male
9 RX			3 TX
6 TX			2 RX
5 GND			5 GND
			

Driver Version:

Version	Date	Description
V1.20	May/11/2011	Added registers: D_bit, M_word, F_word, L_word

LS MASTER-K MODBUS RTU

Supported Series: LS MASTER-K MODBUS RTU

Website: <http://www.lqis.com/>

HMI Setting:

Parameters	Recommended	Options	Notes
PLC type	LS MASTER-K MODBUS RTU		
PLC I/F	RS485 2W		
Baud rate	9600		
Data bits	8	8	
Parity	Even	Even	
Stop bits	1	1	
PLC sta. no.	1		



Device Address:

Bit/Word	Device type	Format	Range	Memo
B	P	DDDDh	0 ~ 9999f	I/O Relay (P)
B	M	DDDDh	0 ~ 9999f	Auxiliary Relay (M)
B	L	DDDDh	0 ~ 9999f	Link Relay (L)
B	K	DDDDh	0 ~ 9999f	Keep Relay (K)
B	F	DDDDh	0 ~ 9999f	Special Relay (F)
B	D_bit	DDDDh	0 ~ 9999f	
W	T	DDDD	0 ~ 9999	Timer (T)
W	C	DDDD	0 ~ 9999	Counter (C)
W	S	DDDD	0 ~ 9999	
W	D	DDDD	0 ~ 9999	Data Register (D)
W	T_double	DDDD	0 ~ 9999	
W	C_double	DDDD	0 ~ 9999	
W	S_double	DDDD	0 ~ 9999	
W	D_double	DDDD	0 ~ 9999	
W	F_word	DDDD	0 ~ 9999	
W	L_word	DDDD	0 ~ 9999	
W	M_word	DDDD	0 ~ 9999	





Wiring Diagram:

The following represents the view of HMI & PLC.



eMT3000 series

COM1 RS232 9P D-Sub Female	COM3 RS232 9P D-Sub Female		RS232 9P D-Sub Male
2 RX	8 RX		3 TX
3 TX	7 TX		2 RX
5 GND	5 GND		5 GND
			

MT6000/8000 series except MT6050i/MT8050i

COM1 RS232 9P D-Sub Female	COM2 RS232 9P D-Sub Female	COM3 RS232 9P D-Sub Male	RS232 9P D-Sub Male
2 RX	6 RX	8 RX	3 TX
3 TX	4 TX	7 TX	2 RX
5 GND	5 GND	5 GND	5 GND
			

MT6050i/MT8050i

COM1 RS232 9P D-Sub Female			RS232 9P D-Sub Male
9 RX			3 TX
6 TX			2 RX
5 GND			5 GND
			

Driver Version:

Version	Date	Description
V1.10	May/11/2011	Added registers: D_bit, M_word, F_word, L_word

LS MASTER-K10S1

Supported Series: LS MASTER-K10S1

Website: <http://www.lgis.com/>

HMI Setting:

Parameters	Recommended	Options	Notes
PLC type	LS MASTER-K10S1		
PLC I/F	RS232	RS232/RS485	
Baud rate	9600		
Data bits	8	8	
Parity	None	None	
Stop bits	1	1	
PLC sta. no.	0		



Device Address:

Bit/Word	Device type	Format	Range	Memo
B	P	DDDh	0 ~ 255f	I/O Relay (P)
B	K	DDDh	0 ~ 255f	Keep Relay (K)
B	M	DDDh	0 ~ 255f	Auxiliary Relay (M)
B	L	DDDh	0 ~ 255f	Link Relay (L)
B	F	DDDh	0 ~ 255f	Special Relay (F)
B	T	DDD	0 ~ 255	Timer (T)
B	C	DDD	0 ~ 255	Counter (C)
W	TV	DDD	0 ~ 255	Timer Present Value
W	CV	DDD	0 ~ 255	Counter Present Value
W	D	DDDD	0 ~ 9999	Data Register (D)





Wiring Diagram:

The following represents the view of HMI & PLC.



Driver eMT3000 series

COM1 RS232 9P D-Sub Female	COM3 RS232 9P D-Sub Female		RS232 9P D-Sub Male
2 RX	8 RX		3 TX
3 TX	7 TX		2 RX
5 GND	5 GND		5 GND
			

MT6000/8000 series except MT6050i/MT8050i

COM1 RS232 9P D-Sub Female	COM2 RS232 9P D-Sub Female	COM3 RS232 9P D-Sub Male	RS232 9P D-Sub Male
2 RX	6 RX	8 RX	3 TX
3 TX	4 TX	7 TX	2 RX
5 GND	5 GND	5 GND	5 GND
			

MT6050i/MT8050i

COM1 RS232 9P D-Sub Female			RS232 9P D-Sub Male
9 RX			3 TX
6 TX			2 RX
5 GND			5 GND
			

Version:

Version	Date	Description
V1.00	Sep/08/2009	Driver released.

LS XECH Cnet

Supported Series: LS XGB-XECH CPU Cnet

Website: <http://www.lqis.com/>

HMI Setting:

Parameters	Recommended	Options	Notes
PLC type	LS XECH Cnet		
PLC I/F	RS232	RS232/RS485	
Baud rate	115200	9600 ~ 115200	
Data bits	8	7, 8	
Parity	None	Even, Odd, None	
Stop bits	1	1,2	
PLC sta. no.	0	0 ~ 255	

Device Address:



Bit/Word	Device type	Format	Range	Memo
B	I_Bit	DDD.DD.Dh	0 ~ 127.15.3f	Input device bit
B	Q_Bit	DDD.DD.Dh	0 ~ 127.15.3f	Output device bit
B	U_Bit	DD.DD.DDh	0 ~ 31.15.31f	Analog flag bit
B	A_Bit	DDDDDDh	0 ~ 262143f	Automatic variable bit
B	M_Bit	DDDDDDh	0 ~ 131071f	Direct variable bit
B	R_Bit	DDDDDDh	0 ~ 32767f	Direct variable bit
B	W_Bit	DDDDDDh	0 ~ 65535f	Direct variable bit
B	F_Bit	DDDDh	0 ~ 2047f	System flag bit
B	K_Bit	DDDDh	0 ~ 8399f	Built-in special flag bit
B	L_Bit	DDDDDDh	0 ~ 11263f	High speed link flag bit
B	N_Bit	DDDDDDh	0 ~ 25087f	P2P flag bit
W	A	DDDDDD	0 ~ 262143	Automatic variable
W	I	DDD.DD.D	0 ~ 127.15.3	Input device
W	Q	DDD.DD.D	0 ~ 127.15.3	Output device
W	M	DDDDDD	0 ~ 131071	Direct variable
W	R	DDDDDD	0 ~ 32767	Direct variable
W	W	DDDDDD	0 ~ 65535	Direct variable
W	F	DDDD	0 ~ 2047	System flag
W	K	DDDD	0 ~ 8399	Built-in special flag

Bit/Word	Device type	Format	Range	Memo
W	L	DDDDD	0 ~ 11263	High speed link flag
W	N	DDDDD	0 ~ 25087	P2P flag
W	U	DD.DD.DD	0 ~ 31.15.31	Analog flag





Wiring Diagram:

The following represents the view of HMI & PLC.



eMT3000 series

COM1 RS232 9P D-Sub Female	COM3 RS232 9P D-Sub Female		RS232 Terminal
2 RX	8 RX		TX
3 TX	7 TX		RX
5 GND	5 GND		SG
			

MT6000/8000 series except MT6050i/MT8050i



COM1 RS232 9P D-Sub Female	COM2 RS232 9P D-Sub Female	COM3 RS232 9P D-Sub Male	RS232 Terminal
2 RX	6 RX	8 RX	TX
3 TX	4 TX	7 TX	RX
5 GND	5 GND	5 GND	SG
			

MT6050i/MT8050i



COM1 RS232 9P D-Sub Female			RS232 Terminal
9 RX			TX
6 TX			RX
5 GND			SG
			

The following represents the view of HMI & PLC.



eMT3000 series

COM1 RS485 2W 9P D-Sub Male	COM3 RS485 2W 9P D-Sub Male		RS485 2W Terminal
1 RX-	6 Data-		485-
2 RX+	9 Data+		485+
5 GND	5 GND		GND
			

MT6000/8000 series except MT6050i/MT8050i

COM1 RS485 2W 9P D-Sub Male	COM3 RS485 2W 9P D-Sub Male		RS485 2W Terminal
1 RX-	6 Data-		485-
2 RX+	9 Data+		485+
5 GND	5 GND		GND
			

MT6050i/MT8050i

COM1 RS485 2W 9P D-Sub Female	COM3 RS485 2W 9P D-Sub Female		RS485 2W Terminal
1 RX-	7 Data-		485-
2 RX+	8 Data+		485+
5 GND	5 GND		GND
			

Driver Version:

Version	Date	Description
V1.00	Aug/27/2012	Driver released.

LS XECH FEnet (Ethernet)

Supported Series: LS XGB-XECH CPU Ethernet module.

Website: <http://www.lgis.com/>

HMI Setting:

Parameters	Recommended	Options	Notes
PLC type	LS XECH FEnet (Ethernet)		
PLC I/F	Ethernet		
Port no.	2004		

Device Address:

Bit/Word	Device type	Format	Range	Memo
B	I_Bit	DD.DD.Df	0 ~ 15.15.3f	Input device bit
B	Q_Bit	DD.DD.Df	0 ~ 15.15.3f	Output device bit
B	U_Bit	DD.DD.DDf	0 ~ 31.15.31f	Analog flag bit
B	A_Bit	DDDDh	0 ~ 16383f	Automatic variable bit
B	M_Bit	DDDDh	0 ~ 8191f	Direct variable bit
B	R_Bit	DDDDh	0 ~ 10239f	Direct variable bit
B	W_Bit	DDDDh	0 ~ 10239f	Direct variable bit
B	F_Bit	DDDDh	0 ~ 1023f	System flag bit
B	K_Bit	DDDDh	0 ~ 4095f	Built-in special flag bit
B	L_Bit	DDDDh	0 ~ 2047f	High speed link flag bit
B	N_Bit	DDDDh	0 ~ 5119f	P2P flag bit
W	A	DDDDD	0 ~ 16383	Automatic variable
W	I	DDD.DD.D	0 ~ 15.15.3	Input device
W	Q	DDD.DD.D	0 ~ 15.15.3	Output device
W	M	DDDD	0 ~ 8191	Direct variable
W	R	DDDDD	0 ~ 10239	Direct variable
W	W	DDDDD	0 ~ 10239	Direct variable
W	F	DDDD	0 ~ 1023	System flag
W	K	DDDD	0 ~ 4095	Built-in special flag
W	L	DDDD	0 ~ 2047	High speed link flag
W	N	DDDD	0 ~ 5119	P2P flag
W	U	DD.DD.DD	0 ~ 31.15.31	Analog flag

Wiring Diagram:

Direct connect (crossover cable):

HMI RJ45 Male	Wire Color	Wire Color	PLC RJ45 Male
1 TX+	White/Orange	White/Green	3 RX+
2 TX-	Orange	Green	6 RX-
3 RX+	White/Green	White/Orange	1 TX+
4 BD4+	Blue	Blue	4 BD4+
5 BD4-	White/Blue	White/Blue	5 BD4-
6 RX-	Green	Orange	2 TX-
7 BD3+	White/Brown	White/Brown	7 BD3+
8 BD3-	Brown	Brown	8 BD3-



Through a hub:

HMI RJ45 Male	Wire Color	Wire Color	PLC RJ45 Male
1 TX+	White/Orange	White/Orange	1 TX+
2 TX-	Orange	Orange	2 TX-
3 RX+	White/Green	White/Green	3 RX+
4 BD4+	Blue	Blue	4 BD4+
5 BD4-	White/Blue	White/Blue	5 BD4-
6 RX-	Green	Green	6 RX-
7 BD3+	White/Brown	White/Brown	7 BD3+
8 BD3-	Brown	Brown	8 BD3-



Driver Version:

Version	Date	Description
V1.00	Aug/28/2012	Driver released.

LS XGB Cnet

Supported Series: LS XGB/XGT Series

Website: <http://www.lgis.com/>

HMI Setting:

Parameters	Recommended	Options	Notes
PLC type	LS XGB Cnet		
PLC I/F	RS232	RS232/RS485	
Baud rate	115200	9600~115200	
Data bits	8	7, 8	
Parity	None	Even, Odd, None	
Stop bits	1	1	
PLC sta. no.	1	0-31	

Device Address:



Bit/Word	Device type	Format	Range	Memo
B	P_Bit	DDDDh	0 ~ 2047f	I/O device Bit
B	M_Bit	DDDDh	0 ~ 2047f	Internal device Bit
B	L_Bit	DDDDDh	0 ~ 11263f	Communication device Bit
B	K_Bit	DDDDh	0 ~ 2559f	Preservation device Bit
B	F_Bit	DDDDh	0 ~ 2047f	Special device Bit(write available from 1025)
B	S_Bit	DDDDD	0 ~ 12799	Relay for step control Bit
B	D_Bit	DDDDDh	0 ~ 32767f	Data register_Bit expression (D0000.0)
B	U_Bit	DH.DDh	0.000 ~ 7f.31f	XGK-CPUE : hh(0~1f)
B	T_Bit	DDDD	0 ~ 2047	Timer device Bit
B	C_Bit	DDDD	0 ~ 2047	Counter device Bit
W	P	DDDD	0 ~ 2047	I/O device_2,048 points
W	M	DDDD	0 ~ 2047	Internal device_4,096 points
W	L	DDDDD	0 ~ 11263	Communication device_20,480 points
W	K	DDDD	0 ~ 2559	Preservation device_4,096 points
W	F	DDDD	0 ~ 2047	Special device_4,096 point

Bit/Word	Device type	Format	Range	Memo
W	S	DDDDD	0 ~ 127	Relay for step control
W	D	DDDDD	0 ~ 32767	Data register_5120 words
W	U	DH.DD	0.00 ~ 7f.31	Analog data register_256 words
W	N	DDDDD	0 ~ 21503	Communication data register_3,936 words
W	Z	DDD	0 ~ 127	Index register_128 words
W	T	DDDD	0 ~ 2047	Timer current value register_256 words
W	C	DDDD	0 ~ 2047	Counter current value register_256 words





Wiring Diagram:

The following represents the view of HMI & PLC.



eMT3000 series

COM1 RS232 9P D-Sub Female	COM3 RS232 9P D-Sub Female		RS232 6P Mini-DIN Male
2 RX	8 RX		6 TXD
3 TX	7 TX		2 RXD
5 GND	5 GND		3 GND
			

MT6000/8000 series except MT6050i/MT8050i

COM1 RS232 9P D-Sub Female	COM2 RS232 9P D-Sub Female	COM3 RS232 9P D-Sub Male	RS232 6P Mini-DIN Male
2 RX	6 RX	8 RX	6 TXD
3 TX	4 TX	7 TX	2 RXD
5 GND	5 GND	5 GND	3 GND
			

MT6050i/MT8050i

COM1 RS232 9P D-Sub Female			RS232 6P Mini-DIN Male
9 RX			6 TXD
6 TX			2 RXD
5 GND			3 GND
			

Driver Version:

Version	Date	Description
V1.50	Mar/07/2011	Added registers: P_Bit, M_Bit, L_Bit, K_Bit...etc
V1.70	Jun/28/2012	Change the way to read/write S_Bit.

LS XGB FEnet (Ethernet)

Supported Series: LS XGB/XGT with XBL-EMTA

Website: <http://www.lgis.com/>

HMI Setting:

Parameters	Recommended	Options	Notes
PLC type	LS XGB FEnet (Ethernet)		
PLC I/F	Ethernet		
Port no.	2004		
PLC sta. no.	0	0~255	

PLC Setting:

Communication mode	FEnet Protocol
--------------------	----------------

Device Address:

Bit/Word	Device type	Format	Range	Memo
B	P_Bit	DDDDh	0 ~ 2047f	I/O device Bit
B	M_Bit	DDDDh	0 ~ 2047f	Internal device Bit
B	L_Bit	DDDDDh	0 ~ 11263f	Communication device Bit
B	K_Bit	DDDDh	0 ~ 2559f	Preservation device Bit
B	F_Bit	DDDDh	0 ~ 2047f	Special device Bit(write available from 1025)
B	S_Bit	DDDDD	0 ~ 12799	Relay for step control Bit
B	D_Bit	DDDDDh	0 ~ 32767f	Data register_Bit expression
B	U_Bit	DH.DDh	0.000 ~ 7f.31f	XGK-CPUE : hh(0~1f)
B	T_Bit	DDDD	0 ~ 2047	Timer device Bit
B	C_Bit	DDDD	0 ~ 2047	Counter device Bit
W	P	DDDD	0 ~ 2047	I/O device_2,048 points
W	M	DDDD	0 ~ 2047	Internal device_4,096 points
W	L	DDDDD	0 ~ 11263	Communication device_20,480 points
W	K	DDDD	0 ~ 2559	Preservation device_4,096 points
W	F	DDDD	0 ~ 2047	Special device_4,096 point
W	S	DDDDD	0 ~ 127	Relay for step control

Bit/Word	Device type	Format	Range	Memo
W	D	DDDDD	0 ~ 32767	Data register_5120 words
W	U	DH.DD	0.00 ~ 7f.31	Analog data register_256 words
W	N	DDDDD	0 ~ 21503	Communication data register_3,936 words
W	Z	DDD	0 ~ 127	Index register_128 words
W	T	DDDD	0 ~ 2047	Timer current value register_256 words
W	C	DDDD	0 ~ 2047	Counter current value register_256 words

Wiring Diagram:

Direct connect (crossover cable):

HMI RJ45 Male	Wire Color	Wire Color	PLC RJ45 Male
1 TX+	White/Orange	White/Green	3 RX+
2 TX-	Orange	Green	6 RX-
3 RX+	White/Green	White/Orange	1 TX+
4 BD4+	Blue	Blue	4 BD4+
5 BD4-	White/Blue	White/Blue	5 BD4-
6 RX-	Green	Orange	2 TX-
7 BD3+	White/Brown	White/Brown	7 BD3+
8 BD3-	Brown	Brown	8 BD3-



Through a hub:

HMI RJ45 Male	Wire Color	Wire Color	PLC RJ45 Male
1 TX+	White/Orange	White/Orange	1 TX+
2 TX-	Orange	Orange	2 TX-
3 RX+	White/Green	White/Green	3 RX+
4 BD4+	Blue	Blue	4 BD4+
5 BD4-	White/Blue	White/Blue	5 BD4-
6 RX-	Green	Green	6 RX-
7 BD3+	White/Brown	White/Brown	7 BD3+
8 BD3-	Brown	Brown	8 BD3-



Driver Version:

Version	Date	Description
V1.50	Aug/16/2011	Added registers: P_Bit, M_Bit, L_Bit, K_Bit...etc
V1.60	Jun/28/2012	Change the way to read/write S_Bit.

LS XGI Cnet

Supported Series: LS XGI series communication module XGL-CH2A

Website: <http://www.lgis.com/>

HMI Setting:

Parameters	Recommended	Options	Notes
PLC type	LS XGI Cnet		
PLC I/F	RS232	RS232/RS485 4W	
Baud rate	115200	9600~115200	
Data bits	8	7, 8	
Parity	None	Even, Odd, None	
Stop bits	1	1	
PLC sta. no.	0	0~255	

Device Address:

Bit/Word	Device type	Format	Range	Memo
B	A_Bit	DDDDDDh	0 ~ 262143f	
B	I_Bit	DDD.DD.Dh	0 ~ 127.15.3f	
B	Q_Bit	DDD.DD.Dh	0 ~ 127.15.3f	
B	M_Bit	DDDDDDh	0 ~ 131071f	
B	R_Bit	DDDDDDh	0 ~ 32767f	
B	W_Bit	DDDDDDh	0 ~ 65535f	
B	F_Bit	DDDDh	0 ~ 2047f	
B	K_Bit	DDDDh	0 ~ 8399f	
B	L_Bit	DDDDDDh	0 ~ 11263f	
B	N_Bit	DDDDDDh	0 ~ 25087f	
B	U_Bit	DD.DD.DDh	0 ~ 31.15.31f	
W	A	DDDDDD	0 ~ 262143	
W	I	DDD.DD.D	0 ~ 127.15.3	
W	Q	DDD.DD.D	0 ~ 127.15.3	
W	M	DDDDDD	0 ~ 131071	
W	R	DDDDD	0 ~ 32767	
W	W	DDDDD	0 ~ 65535	
W	F	DDDD	0 ~ 2047	
W	K	DDDD	0 ~ 8399	



Bit/Word	Device type	Format	Range	Memo
W	L	DDDDD	0 ~ 11263	
W	N	DDDDD	0 ~ 25087	
W	U	DD.DD.DD	0 ~ 31.15.31	

Wiring Diagram:





The following represents the view of HMI & PLC.

9P D-Sub to 9P D-Sub:



eMT3000 series

COM1 RS232 9P D-Sub Female	COM3 RS232 9P D-Sub Female		XGL-CH2A CH1 RS232 9P D-Sub Male
2 RX	8 RX		3 TXD
3 TX	7 TX		2 RXD
5 GND	5 GND		5 GND
			

MT6000/8000 series except MT6050i/MT8050i

COM1 RS232 9P D-Sub Female	COM2 RS232 9P D-Sub Female	COM3 RS232 9P D-Sub Male	XGL-CH2A CH1 RS232 9P D-Sub Male
2 RX	6 RX	8 RX	3 TXD
3 TX	4 TX	7 TX	2 RXD
5 GND	5 GND	5 GND	5 GND
			



MT6050i/MT8050i

COM1 RS232 9P D-Sub Female			XGL-CH2A CH1 RS232 9P D-Sub Male
9 RX			3 TXD
6 TX			2 RXD
5 GND			5 GND
			



The following represents the view of HMI & PLC.

9P D-Sub to Terminals:



eMT3000 series

COM1 RS485 4W 9P D-Sub Male			XGL-CH2A CH2 5P Terminal
1 RX-			TXD-
2 RX+			TXD+
3 TX-			RXD-
4 TX+			RXD+
5 GND			GND
			

MT6000/8000 series except MT6050i/MT8050i

COM1 RS485 4W 9P D-Sub Male			XGL-CH2A CH2 5P Terminal
1 RX-			TXD-
2 RX+			TXD+
3 TX-			RXD-
4 TX+			RXD+
5 GND			GND
			

MT6050i/MT8050i

COM1 RS485 4W 9P D-Sub Female			XGL-CH2A CH2 5P Terminal
1 RX-			TXD-
2 RX+			TXD+
3 TX-			RXD-
4 TX+			RXD+
5 GND			GND
			

Driver Version:

Version	Date	Description
V1.00	May/23/2012	Driver released

LS XGI CPU DIRECT

Supported Series: LS XGI CPU RS232 port.

Website: <http://www.lgis.com/>

HMI Setting:

Parameters	Recommended	Options	Notes
PLC type	LS XGI CPU DIRECT		
PLC I/F	RS232	RS232	
Baud rate	115200	9600~115200	
Data bits	8	7, 8	
Parity	None	Even, Odd, None	
Stop bits	1	1	
PLC sta. no.	1	1	

Device Address:



Bit/Word	Device type	Format	Range	Memo
B	A_Bit	DDDDDDh	0 ~ 262143f	
B	I_Bit	DDD.DD.Dh	0 ~ 127.15.3f	
B	Q_Bit	DDD.DD.Dh	0 ~ 127.15.3f	
B	M_Bit	DDDDDDh	0 ~ 131071f	
B	R_Bit	DDDDh	0 ~ 32767f	
B	W_Bit	DDDDh	0 ~ 65535f	
B	F_Bit	DDDDh	0 ~ 2047f	
B	K_Bit	DDDDh	0 ~ 8399f	
B	L_Bit	DDDDh	0 ~ 11263f	
B	N_Bit	DDDDh	0 ~ 25087f	
B	U_Bit	DD.DD.DDh	0 ~ 31.15.31f	
W	A	DDDDDD	0 ~ 262143	
W	I	DDD.DD.D	0 ~ 127.15.3	
W	Q	DDD.DD.D	0 ~ 127.15.3	
W	M	DDDDDD	0 ~ 131071	
W	R	DDDDD	0 ~ 32767	
W	W	DDDDD	0 ~ 65535	
W	F	DDDD	0 ~ 2047	

Bit/Word	Device type	Format	Range	Memo
W	K	DDDD	0 ~ 8399	
W	L	DDDDD	0 ~ 11263	
W	N	DDDDD	0 ~ 25087	
W	U	DD.DD.DD	0 ~ 31.15.31	



Wiring Diagram:

The following represents the view of HMI & PLC.



eMT3000 series

COM1 RS232 9P D-Sub Female	COM3 RS232 9P D-Sub Female		RS232 9P D-Sub Male
2 RX	8 RX		3 TXD
3 TX	7 TX		2 RXD
5 GND	5 GND		5 GND
			

MT6000/8000 series except MT6050i/MT8050i

COM1 RS232 9P D-Sub Female	COM2 RS232 9P D-Sub Female	COM3 RS232 9P D-Sub Male	RS232 9P D-Sub Male
2 RX	6 RX	8 RX	3 TXD
3 TX	4 TX	7 TX	2 RXD
5 GND	5 GND	5 GND	5 GND
			

MT6050i/MT8050i

COM1 RS232 9P D-Sub Female			RS232 9P D-Sub Male
9 RX			3 TXD
6 TX			2 RXD
5 GND			5 GND
			

Driver Version:

Version	Date	Description
V1.00	May/17/2012	Driver released.

LS XGI FEnet (Ethernet)

Supported Series: LS XGI series XGL-EFMT Ethernet module.

Website: <http://www.lgjs.com/>

HMI Setting:

Parameters	Recommended	Options	Notes
PLC type	LS XGI FEnet (Ethernet)		
PLC I/F	Ethernet		
Port no.	2004		
PLC sta. no.	0		

Device Address:

Bit/Word	Device type	Format	Range	Memo
B	A_Bit	DDDDDDh	0 ~ 262143f	
B	I_Bit	DDD.DD.Dh	0 ~ 127.15.3f	
B	Q_Bit	DDD.DD.Dh	0 ~ 127.15.3f	
B	M_Bit	DDDDDDh	0 ~ 131071f	
B	R_Bit	DDDDDDh	0 ~ 32767f	
B	W_Bit	DDDDDDh	0 ~ 65535f	
B	F_Bit	DDDDh	0 ~ 2047f	
B	K_Bit	DDDDh	0 ~ 8399f	
B	L_Bit	DDDDDDh	0 ~ 11263f	
B	N_Bit	DDDDDDh	0 ~ 25087f	
B	U_Bit	DD.DD.DDh	0 ~ 31.15.31f	
W	A	DDDDDD	0 ~ 262143	
W	I	DDD.DD.D	0 ~ 127.15.3	
W	Q	DDD.DD.D	0 ~ 127.15.3	
W	M	DDDDDD	0 ~ 131071	
W	R	DDDDD	0 ~ 32767	
W	W	DDDDD	0 ~ 65535	
W	F	DDDD	0 ~ 2047	
W	K	DDDD	0 ~ 8399	
W	L	DDDDD	0 ~ 11263	
W	N	DDDDD	0 ~ 25087	
W	U	DD.DD.DD	0 ~ 31.15.31	

Wiring Diagram:

Direct connect (crossover cable):

HMI RJ45 Male	Wire Color	Wire Color	PLC RJ45 Male
1 TX+	White/Orange	White/Green	3 RX+
2 TX-	Orange	Green	6 RX-
3 RX+	White/Green	White/Orange	1 TX+
4 BD4+	Blue	Blue	4 BD4+
5 BD4-	White/Blue	White/Blue	5 BD4-
6 RX-	Green	Orange	2 TX-
7 BD3+	White/Brown	White/Brown	7 BD3+
8 BD3-	Brown	Brown	8 BD3-



Through a hub:

HMI RJ45 Male	Wire Color	Wire Color	PLC RJ45 Male
1 TX+	White/Orange	White/Orange	1 TX+
2 TX-	Orange	Orange	2 TX-
3 RX+	White/Green	White/Green	3 RX+
4 BD4+	Blue	Blue	4 BD4+
5 BD4-	White/Blue	White/Blue	5 BD4-
6 RX-	Green	Green	6 RX-
7 BD3+	White/Brown	White/Brown	7 BD3+
8 BD3-	Brown	Brown	8 BD3-



Driver Version:

Version	Date	Description
V1.00	May/21/2012	Driver released.

LS XGK Cnet

Supported Series: LS XGT series communication module XGL-CH2A

Website: <http://www.lgis.com/>

HMI Setting:

Parameters	Recommended	Options	Notes
PLC type	LS XGK Cnet		
PLC I/F	RS232	RS232/RS485 4W	
Baud rate	115200	9600~115200	
Data bits	8	7, 8	
Parity	None	Even, Odd, None	
Stop bits	1	1	
PLC sta. no.	1	0~32	

Device Address:

Bit/Word	Device type	Format	Range	Memo
B	P_Bit	DDDDh	0 ~ 2047f	I/O device Bit
B	M_Bit	DDDDh	0 ~ 2047f	Internal device Bit
B	L_Bit	DDDDDh	0 ~ 11263f	Communication device Bit
B	K_Bit	DDDDh	0 ~ 2559f	Preservation device Bit
B	F_Bit	DDDDh	0 ~ 2047f	Special device Bit(write available from 1025)
B	S_Bit	DDDDD	0 ~ 12799	Relay for step control Bit
B	D_Bit	DDDDDh	0 ~ 32767f	Data register_Bit expression (D0000.0)
B	U_Bit	DH.DDh	0.000 ~ 3f.31f	XGK-CPUE : hh(0~1f)
B	T_Bit	DDDD	0 ~ 2047	Timer device Bit
B	C_Bit	DDDD	0 ~ 2047	Counter device Bit
W	P	DDDD	0 ~ 2047	I/O device
W	M	DDDD	0 ~ 2047	Internal device
W	L	DDDDD	0 ~ 11263	Communication device
W	K	DDDD	0 ~ 2559	Preservation device
W	F	DDDD	0 ~ 2047	Special device(write available from 1025)



Bit/Word	Device type	Format	Range	Memo
W	S	DDDDD	0 ~ 127	Relay for step control
W	D	DDDDD	0 ~ 32767	Data register
W	U	DH.DD	0.00 ~ 3f.31	Analog data register XGK-CPUE : hh(0~1f)
W	N	DDDDD	0 ~ 21503	Communication data register
W	Z	DDD	0 ~ 127	Index register_128 words
W	T	DDDD	0 ~ 2047	Timer current value register
W	C	DDDD	0 ~ 2047	Counter current value register
W	R	DDDDD	0 ~ 32767	
W	ZR	DDDDD	0 ~ 32767	

Wiring Diagram:





The following represents the view of HMI & PLC.

9P D-Sub to 9P D-Sub:



eMT3000 series

COM1 RS232 9P D-Sub Female	COM3 RS232 9P D-Sub Female		XGL-CH2A CH1 RS232 9P D-Sub Male
2 RX	8 RX		3 TXD
3 TX	7 TX		2 RXD
5 GND	5 GND		5 GND
			

MT6000/8000 series except MT6050i/MT8050i

COM1 RS232 9P D-Sub Female	COM2 RS232 9P D-Sub Female	COM3 RS232 9P D-Sub Male	XGL-CH2A CH1 RS232 9P D-Sub Male
2 RX	6 RX	8 RX	3 TXD
3 TX	4 TX	7 TX	2 RXD
5 GND	5 GND	5 GND	5 GND
			



MT6050i/MT8050i

COM1 RS232 9P D-Sub Female			XGL-CH2A CH1 RS232 9P D-Sub Male
9 RX			3 TXD
6 TX			2 RXD
5 GND			5 GND
			



The following represents the view of HMI & PLC.

9P D-Sub to Terminals:



eMT3000 series

COM1 RS485 4W 9P D-Sub Male			XGL-CH2A CH2 5P Terminal
1 RX-			TXD-
2 RX+			TXD+
3 TX-			RXD-
4 TX+			RXD+
5 GND			GND
			

MT6000/8000 series except MT6050i/MT8050i

COM1 RS485 4W 9P D-Sub Male			XGL-CH2A CH2 5P Terminal
1 RX-			TXD-
2 RX+			TXD+
3 TX-			RXD-
4 TX+			RXD+
5 GND			GND
			

MT6050i/MT8050i

COM1 RS485 4W 9P D-Sub Female			XGL-CH2A CH2 5P Terminal
1 RX-			TXD-
2 RX+			TXD+
3 TX-			RXD-
4 TX+			RXD+
5 GND			GND
			

Driver Version:

Version	Date	Description
V1.30	Feb /25/2011	Added registers: P_Bit, M_Bit, L_Bit, K_Bit...etc
V1.40	Jun/20/2012	Change the way to read/write S_Bit.

LS XGK FEnet (Ethernet)

Supported Series: LS XGT series XGL-EFMT Ethernet module.

Website: <http://www.lgjs.com/>

HMI Setting:

Parameters	Recommended	Options	Notes
PLC type	LS XGK FEnet (Ethernet)		
PLC I/F	Ethernet		
Port no.	2004		
PLC sta. no.	0		

Device Address:

Bit/Word	Device type	Format	Range	Memo
B	P_Bit	DDDDh	0 ~ 2047f	I/O device Bit
B	M_Bit	DDDDh	0 ~ 2047f	Internal device Bit
B	L_Bit	DDDDDh	0 ~ 11263f	Communication device Bit
B	K_Bit	DDDDh	0 ~ 2559f	Preservation device Bit
B	F_Bit	DDDDh	0 ~ 2047f	Special device Bit(write available from 1025)
B	S_Bit	DDDDD	0 ~ 12799	Relay for step control Bit
B	D_Bit	DDDDDh	0 ~ 32767f	Data register_Bit expression (D0000.0)
B	U_Bit	DH.DDh	0.000 ~ 3f.31f	XGK-CPUE : hh(0~1f)
B	T_Bit	DDDD	0 ~ 2047	Timer device Bit
B	C_Bit	DDDD	0 ~ 2047	Counter device Bit
W	P	DDDD	0 ~ 2047	I/O device
W	M	DDDD	0 ~ 2047	Internal device
W	L	DDDDD	0 ~ 11263	Communication device
W	K	DDDD	0 ~ 2559	Preservation device
W	F	DDDD	0 ~ 2047	Special device(write available from 1025)
W	S	DDDDD	0 ~ 127	Relay for step control
W	D	DDDDD	0 ~ 32767	Data register

Bit/Word	Device type	Format	Range	Memo
W	U	DH.DD	0.00 ~ 3f.31	Analog data register XGK-CPUE : hh(0~1f)
W	N	DDDDD	0 ~ 21503	Communication data register
W	Z	DDD	0 ~ 127	Index register_128 words
W	T	DDDD	0 ~ 2047	Timer current value register
W	C	DDDD	0 ~ 2047	Counter current value register
W	R	DDDDD	0 ~ 32767	
W	ZR	DDDDD	0 ~ 32767	

Wiring Diagram:

Direct connect (crossover cable):

HMI RJ45 Male	Wire Color	Wire Color	PLC RJ45 Male
1 TX+	White/Orange	White/Green	3 RX+
2 TX-	Orange	Green	6 RX-
3 RX+	White/Green	White/Orange	1 TX+
4 BD4+	Blue	Blue	4 BD4+
5 BD4-	White/Blue	White/Blue	5 BD4-
6 RX-	Green	Orange	2 TX-
7 BD3+	White/Brown	White/Brown	7 BD3+
8 BD3-	Brown	Brown	8 BD3-



Through a hub:

HMI RJ45 Male	Wire Color	Wire Color	PLC RJ45 Male
1 TX+	White/Orange	White/Orange	1 TX+
2 TX-	Orange	Orange	2 TX-
3 RX+	White/Green	White/Green	3 RX+
4 BD4+	Blue	Blue	4 BD4+
5 BD4-	White/Blue	White/Blue	5 BD4-
6 RX-	Green	Green	6 RX-
7 BD3+	White/Brown	White/Brown	7 BD3+
8 BD3-	Brown	Brown	8 BD3-



Driver Version:

Version	Date	Description
V1.30	Mar/10/2011	Added registers: P_Bit, M_Bit, L_Bit, K_Bit...etc
V1.40	Jun/19/2012	Change the way to read/write S_Bit.

LS XGT/XGK CPU DIRECT

Supported Series: LS XGT/XGK CPU RS232 port.

Website: <http://www.lgis.com/>

HMI Setting:

Parameters	Recommended	Options	Notes
PLC type	LS XGT/XGK CPU DIRECT		
PLC I/F	RS232	RS232	
Baud rate	115200	9600~115200	
Data bits	8	7, 8	
Parity	None	Even, Odd, None	
Stop bits	1	1	
PLC sta. no.	1	1	

Device Address:



Bit/Word	Device type	Format	Range	Memo
B	P_Bit	DDDDh	0 ~ 2047f	I/O device Bit
B	M_Bit	DDDDh	0 ~ 2047f	Internal device Bit
B	L_Bit	DDDDDh	0 ~ 11263f	Communication device Bit
B	K_Bit	DDDDh	0 ~ 2559f	Preservation device Bit
B	F_Bit	DDDDh	0 ~ 2047f	Special device Bit(write available from 1025)
B	S_Bit	DDDDD	0 ~ 12799	Relay for step control Bit
B	D_Bit	DDDDDh	0 ~ 32767f	Data register_Bit expression
B	U_Bit	DH.DDh	0.000 ~ 3f.31f	XGK-CPUE : hh(0~1f)
B	T_Bit	DDDD	0 ~ 2047	Timer device Bit
B	C_Bit	DDDD	0 ~ 2047	Counter device Bit
W	P	DDDD	0 ~ 2047	I/O device
W	M	DDDD	0 ~ 2047	Internal device
W	L	DDDDD	0 ~ 11263	Communication device
W	K	DDDD	0 ~ 2559	Preservation device
W	F	DDDD	0 ~ 2047	Special device(write available from 1025)

Bit/Word	Device type	Format	Range	Memo
W	S	DDDDD	0 ~ 127	Relay for step control
W	D	DDDDD	0 ~ 32767	Data register
W	U	DH.DD	0.00 ~ 3f.31	Analog data register XGK-CPUE : hh(0~1f)
W	N	DDDDD	0 ~ 21503	Communication data register
W	Z	DDD	0 ~ 127	Index register_128 words
W	T	DDDD	0 ~ 2047	Timer current value register
W	C	DDDD	0 ~ 2047	Counter current value
W	R	DDDDD	0 ~ 32767	
W	ZR	DDDDD	0 ~ 32767	
W	TS	DDDD	0 ~ 2047	Setup value
W	CS	DDDD	0 ~ 2047	Setup value





Wiring Diagram:

The following represents the view of HMI & PLC.



eMT3000 series

COM1 RS232 9P D-Sub Female	COM3 RS232 9P D-Sub Female		RS232 9P D-Sub Male
2 RX	8 RX		3 TXD
3 TX	7 TX		2 RXD
5 GND	5 GND		5 GND
			

MT6000/8000 series except MT6050i/MT8050i

COM1 RS232 9P D-Sub Female	COM2 RS232 9P D-Sub Female	COM3 RS232 9P D-Sub Male	RS232 9P D-Sub Male
2 RX	6 RX	8 RX	3 TXD
3 TX	4 TX	7 TX	2 RXD
5 GND	5 GND	5 GND	5 GND
			

MT6050i/MT8050i

COM1 RS232 9P D-Sub Female			RS232 9P D-Sub Male
9 RX			3 TXD
6 TX			2 RXD
5 GND			5 GND
			

Driver Version:

Version	Date	Description
V1.40	Mar/10/2011	Added registers: P_Bit, M_Bit, L_Bit, K_Bit...etc
V1.60	Jun/18/2012	Change the way to read/write S_Bit.

LS Mecapion Metronix AnyPack

HMI Setting:

Parameters	Recommended	Options	Notes
PLC type	LS Mecapion Metronix AnyPack		
PLC I/F	RS232		
Baud rate	9600		
Data bits	8		
Parity	None		
Stop bits	1		
PLC sta. no.	0		



Device Address:

Bit/Word	Device Type	Format	Range	Memo
B	MX_L16bit	DDDDDDdd	0 ~ 9999915	MD Low 16bit
B	MX_H16bit	DDDDDDdd	0 ~ 9999915	MD High 16bit
DW	MD	DDDD	0 ~ 9999	





Wiring Diagram:

The following represents the view of HMI & PLC.



eMT3000 series

COM1 RS232 9P D-Sub Female	COM3 RS232 9P D-Sub Female		PLC RS232 Terminal	
2 RX	8 RX		6 TX	
3 TX	7 TX		5 RX	
5 GND	5 GND		11 GND	circuit
			12 GND	
				

MT6000/8000 series except MT6050i/MT8050i

COM1 RS232 9P D-Sub Female	COM2 RS232 9P D-Sub Female	COM3 RS232 9P D-Sub Male	PLC RS232 Terminal	
2 RX	6 RX	8 RX	6 TX	
3 TX	4 TX	7 TX	5 RX	
5 GND	5 GND	5 GND	11 GND	circuit
			12 GND	
				

MT6050i/MT8050i

COM1 RS232 9P D-Sub Female			PLC RS232 Terminal	
9 RX			6 TX	
6 TX			5 RX	
5 GND			11 GND	circuit
			12 GND	
				

Driver Version:

Version	Date	Description
V1.00	Jul/1/2008	

Master-Slave Server

For more information, please refer to User's Manual CH28.

HMI Setting:

Parameters	Recommended	Options	Notes
PLC type	Master-Slave Server		
PLC I/F	RS232	RS232/RS485	
Baud rate	115200	9600~115200	
Data bits	8	7,8	
Parity	Even	None,Even,Odd,Mark,Space	
Stop bits	1	1,2	
HMI sta. no.	0		
PLC sta. no.	0		

FOR MT500 HMI Setting:

Parameters	Recommended	Options	Notes
PLC type	Master (Master-Slave Protocol)		
PLC I/F	RS232		
Baud rate	115200	38400, 115200	
Data bits	8		
Parity	Even		
Stop bits	1		
HMI sta. no.	0		
PLC sta. no.	0		
Parameter 1	MT500 PLC ID	Use PLCAddressView.exe to find PLC ID.	

To connect HMI with MT500, MT500 has to be set as [Slave].

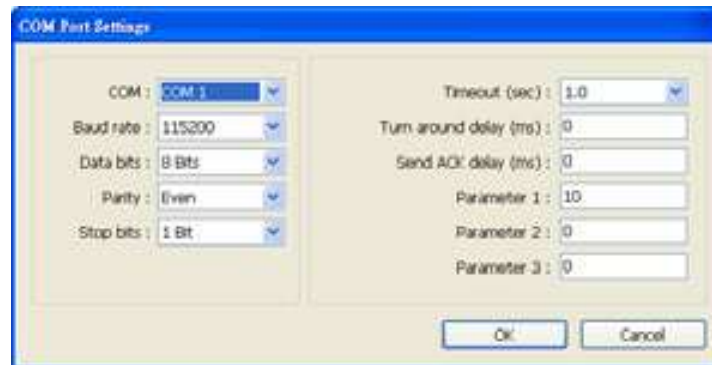

PLC Setting:

Communication mode	MT500 Multiple HMI set Slave.
--------------------	-------------------------------

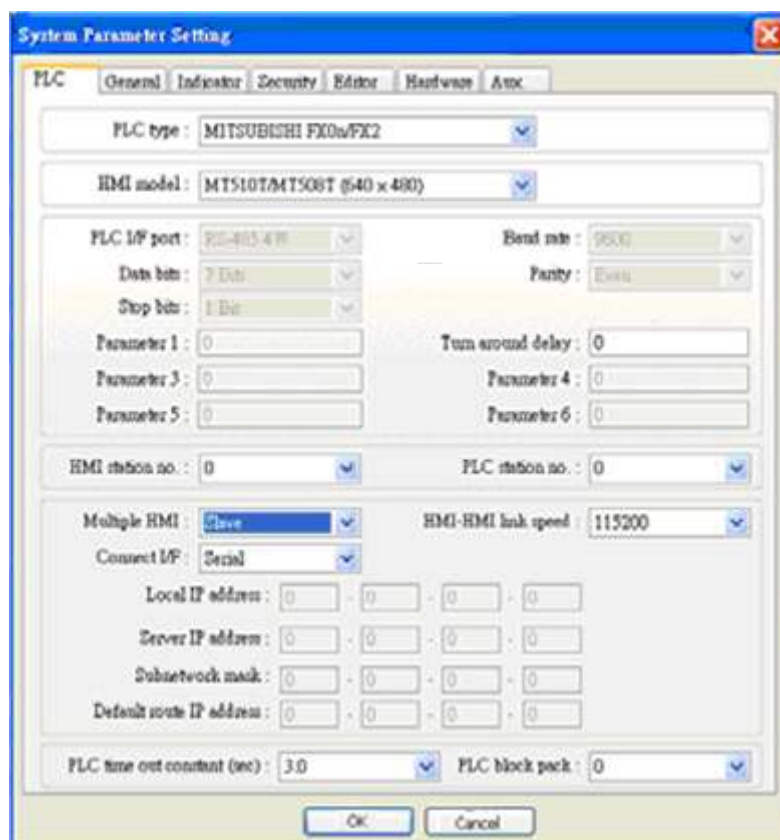

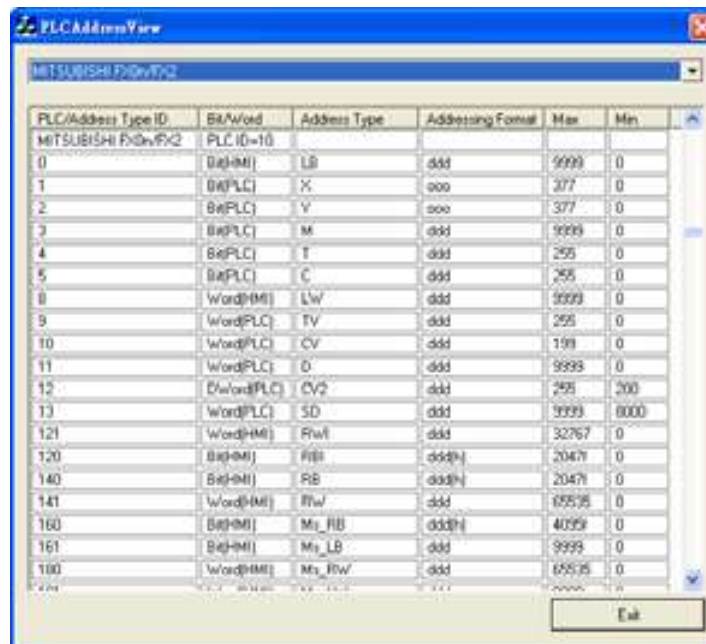

PLC/Address Type ID	Bit/Word	Address Type	Addressing Format	Max	Min
MITSUBISHI Fx0n/Fx2	PLC ID=10				
0	Bit(HMI)	LB	ddd	9999	0
1	Bit(PLC)	X	ooo	377	0
2	Bit(PLC)	Y	ooo	377	0
3	Bit(PLC)	M	ddd	9999	0
4	Bit(PLC)	T	ddd	255	0
5	Bit(PLC)	C	ddd	255	0
8	Word(HMI)	LW	ddd	9999	0
9	Word(PLC)	TV	ddd	255	0
10	Word(PLC)	CV	ddd	199	0
11	Word(PLC)	D	ddd	9999	0
12	D/Word(PLC)	CV2	ddd	255	200
13	Word(PLC)	SD	ddd	9999	0000
121	Word(HMI)	RW	ddd	32767	0
120	Bit(HMI)	RBI	ddd(h)	2047	0
140	Bit(HMI)	RB	ddd(h)	2047	0
141	Word(HMI)	RW	ddd	65535	0
160	Bit(HMI)	Ms_RB	ddd(h)	4095	0
161	Bit(HMI)	Ms_LB	ddd	9999	0
160	Word(HMI)	Ms_RW	ddd	65535	0

Device Address:

Bit/Word	MT500	MT8000	Range	Memo
B	Ms_RB	RW_Bit	ddd: 0 ~ 4095 (h): 0 ~ f	
B	Ms_LB	LB	ddd:0 ~ 9999	
W	Ms_RW	RW	ddd:0 ~ 65535	
W	Ms_LW	LW	ddd:0 ~ 9999	

Driver Version:

Version	Date	Description
V1.00	Dec/30/2008	Driver released.

Memory Map

Memory Map protocol is similar to IBM 3764R communication protocol. EasyBuilder reserves 512 words of data memory to use with this protocol. EasyBuilder must update the values in these words. EasyBuilder uses these words to display data and control parts status on screen. When touch actions are taken, data is sent to the others once, and then update the memory in it. The HMI should always update the data memory.

HMI Setting:

Parameters	Recommended	Options	Notes
PLC type	Memory Map		
PLC I/F	RS232	RS232, RS485 4W, 2W	RS232 default
Baud rate	115200	9600~115200	
Data bits	8		
Parity	Even	Even, Odd, None	
Stop bits	1		

Device Address:

Bit/Word	Device type	Format	Range	Memo
B	MB	DDDDh	0 ~ 4095f	
W	MW	DDDD	0 ~ 9999	



MB and MW share the same data storage.

MW 0 = MB 00000 ~ MB 0000f, MW 1 = MB 00010 ~ MB 0001f





Wiring Diagram:

The following represents the view of HMI & PLC.



eMT3000 series

COM1 RS232 9P D-Sub Female	COM3 RS232 9P D-Sub Female		HMI COM1 RS232 9P D-Sub Female
2 RX	8 RX		3 TX
3 TX	7 TX		2 RX
5 GND	5 GND		5 GND
			

MT6000/8000 series except MT6050i/MT8050i



COM1 RS232 9P D-Sub Female	COM2 RS232 9P D-Sub Female	COM3 RS232 9P D-Sub Male	HMI COM1 RS232 9P D-Sub Female
2 RX	6 RX	8 RX	3 TX
3 TX	4 TX	7 TX	2 RX
5 GND	5 GND	5 GND	5 GND
			

MT6050i/MT8050i



COM1 RS232 9P D-Sub Female			HMI COM1 RS232 9P D-Sub Female
9 RX			3 TX
6 TX			2 RX
5 GND			5 GND
			

The following represents the view of HMI & PLC.



eMT3000 series

COM1 RS485 2W 9P D-Sub Male	COM3 RS485 2W 9P D-Sub Male		HMI COM1 RS485 2W 9P D-Sub Male
1 RX-	6 Data-		1 RX-
2 RX+	9 Data+		2 RX+
5 GND	5 GND		5 GND
			

MT6000/8000 series except MT6050i/MT8050i



COM1 RS485 2W 9P D-Sub Male	COM3 RS485 2W 9P D-Sub Male		HMI COM1 RS485 2W 9P D-Sub Male
1 RX-	6 Data-		1 RX-
2 RX+	9 Data+		2 RX+
5 GND	5 GND		5 GND
			

MT6050i/MT8050i



COM1 RS485 2W 9P D-Sub Female	COM3 RS485 2W 9P D-Sub Female		HMI COM1 RS485 2W 9P D-Sub Female
1 RX-	7 Data-		1 RX-
2 RX+	8 Data+		2 RX+
5 GND	5 GND		5 GND
			

The following represents the view of HMI & PLC.



eMT3000 series

COM1 RS485 4W 9P D-Sub Male			HMI COM1 RS485 4W 9P D-Sub Male
1 RX-			3 TX-
2 RX+			4 TX+
3 TX-			1 RX-
4 TX+			2 RX+
5 GND			5 GND
			

MT6000/8000 series except MT6050i/MT8050i

COM1 RS485 4W 9P D-Sub Male			HMI COM1 RS485 4W 9P D-Sub Male
1 RX-			3 TX-
2 RX+			4 TX+
3 TX-			1 RX-
4 TX+			2 RX+
5 GND			5 GND
			

MT6050i/MT8050i

COM1 RS485 4W 9P D-Sub Female			HMI COM1 RS485 4W 9P D-Sub Female
1 RX-			3 TX-
2 RX+			4 TX+
3 TX-			1 RX-
4 TX+			2 RX+
5 GND			5 GND
			

Note:

For Memory map information, please refer to User's Manual "Chapter 31 Memory Map Communication".

Driver Version:

Version	Date	Description
V1.00	Mar/19/2009	Driver released.

MIKOM MX Series PLC

Support series: MIKOM MX series PLC

Web: <http://www.mikom.com.cn/>

HMI Setting:

Parameters	Recommended	Options	Notes
PLC type	MIKOM MX Series PLC		
PLC I/F	RS232	RS232/485/Ethernet	
Baud rate	19200	9600~115200	
Data bits	Even	None,Even,Odd	
Parity	8	8	
Stop bits	1	1,2	
PLC sta. no.	1	0~31	

Online simulator	YES
------------------	-----

PLC Setting:

PORT 0(RS232 Setting)

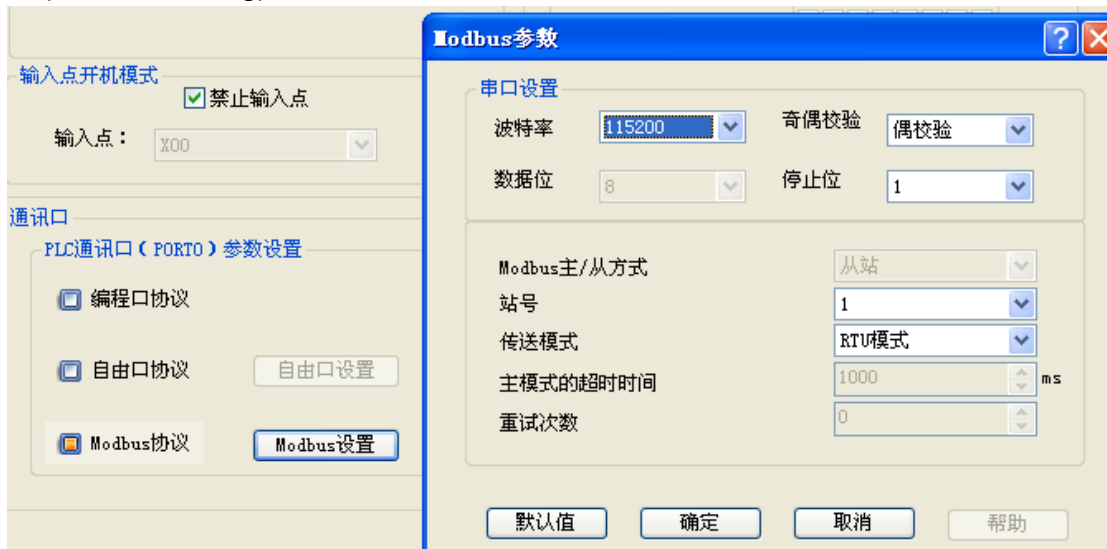

PORT 1(RS485 Setting)





Device Address:

Bit/Word	Device type	Format	Range	Memo
B	Y	DDD	0~777	Output Relay
B	X	DDD	0~777	Input Relay
B	M	DDDD	0~4095	Auxiliary Relay
B	SM	DDD	0-511	Special Auxiliary Relay
B	S	DDDD	0~1535	Step Relay
B	T	DDD	0~511	Timer Relay
B	C	DDD	0~511	Counter Relay
W	D	DDDDD	0~32767	Data Register
W	SD	DDD	0~511	Special Data Register
W	Z	DDD	0~255	Indexed Addressing Register
W	T	DDD	0~511	Timer
W	C	DDD	0~199	Counter
W	U0	DDD	0~199	Special Module Register
W	U1	DDD	0~199	Special Module Register
W	U2	DDD	0~199	Special Module Register
W	U3	DDD	0~199	Special Module Register
W	U4	DDD	0~199	Special Module Register
W	U5	DDD	0~199	Special Module Register
W	U6	DDD	0~199	Special Module Register
W	U7	DDD	0~199	Special Module Register
DW	C-32bit	DDD	200~511	32 Bit Counter





Wiring Diagram:

The following represents the view of HMI & PLC.



eMT3000 series

COM1 RS232 9P D-Sub Female	COM3 RS232 9P D-Sub Female		RS232 8P Mini-DIN Male
2 RX	8 RX		3 TX
3 TX	7 TX		2 RX
5 GND	5 GND		5 GND
			

MT6000/8000 series except MT6050i/MT8050i

COM1 RS232 9P D-Sub Female	COM2 RS232 9P D-Sub Female	COM3 RS232 9P D-Sub Male	RS232 8P Mini-DIN Male
2 RX	6 RX	8 RX	3 TX
3 TX	4 TX	7 TX	2 RX
5 GND	5 GND	5 GND	5 GND
			

MT6050i/MT8050i

COM1 RS232 9P D-Sub Female			RS232 8P Mini-DIN Male
9 RX			3 TX
6 TX			2 RX
5 GND			5 GND
			

Driver Version:

Version	Date	Description
V1.00	May/3/2012	Driver released.

Mitsubishi A1S/A2N

Supported Series: Mitsubishi A1S/A2N

Website: <http://www.mitsubishi-automation.com/>

HMI Setting:

Parameters	Recommended	Options	Notes
PLC type	Mitsubishi A1S/A2N		
PLC I/F	RS232		
Baud rate	9600		
Data bits	8		
Parity	Odd		
Stop bits	1		
PLC sta. no.	0		

Device Address:

Bit/Word	Device type	Format	Range	Memo
B	X	HHHH	0 ~ ffff	Input Relay
B	Y	HHHH	0 ~ ffff	Output Relay
B	M	DDDDD	0 ~ 65535	Auxiliary Relay
B	B	HHHH	0 ~ ffff	
B	F	DDDDD	0 ~ 65535	
W	TV	DDDDD	0 ~ 65535	Timer Memory
W	CV	DDDDD	0 ~ 65535	Counter Memory
W	D	DDDDD	0 ~ 65535	Data Register
W	W	HHHH	0 ~ ffff	
W	R	DDDDD	0 ~ 65535	

Wiring Diagram:

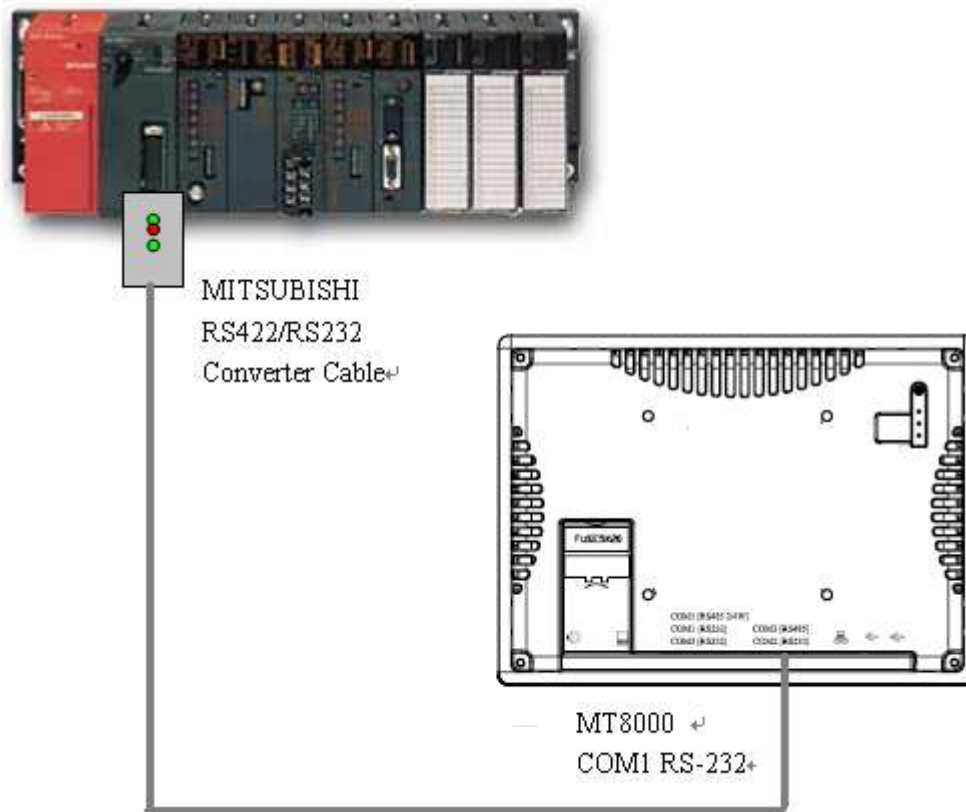

Use the RS422 to RS232 PLC programming cable (shown as follows)

MITSUBISHI AnS CPU





The following represents the view of HMI & PLC.

eMT3000 series

COM1 RS232 9P D-Sub Female	PLC Programming Converter		Mitsubishi RS422 25P D-Sub Male
2 RX	TX	TX+	2 RX+
3 TX	RX	RX+	3 TX+
5 GND	GND	DTR+	4 DSR+
7 RTS	CTS	GND	7 GND
8 CTS	RTS	TX-	15 RX-
		RX-	16 TX-
		DTR-	17 DSR-
			

MT6000/8000 series except MT6050i/MT8050i

COM1 RS232 9P D-Sub Female	PLC Programming Converter		Mitsubishi RS422 25P D-Sub Male
2 RX	TX	TX+	2 RX+
3 TX	RX	RX+	3 TX+
5 GND	GND	DTR+	4 DSR+
7 RTS	CTS	GND	7 GND
8 CTS	RTS	TX-	15 RX-
		RX-	16 TX-
		DTR-	17 DSR-
			

Driver Version:

Version	Date	Description
V1.00	Sep/18/2009	Driver released.

Mitsubishi A2A/A2U/A2AS/A2USH

Supported Series: Mitsubishi A2A,A2U,A2AS,A2USH

Website: <http://www.mitsubishi-automation.com/>

HMI Setting:

Parameters	Recommended	Options	Notes
PLC type	Mitsubishi A2A/A2U/A2AS/A2USH		
PLC I/F	RS232		
Baud rate	9600		
Data bits	8		
Parity	Odd		
Stop bits	1		
PLC sta. no.	0		

Device Address:

Bit/Word	Device type	Format	Range	Memo
B	X	HHHH	0 ~ 270f	Input Relay
B	Y	HHHH	0 ~ 270f	Output Relay
B	M	DDDD	0 ~ 9999	Auxiliary Relay
B	B	HHHH	0 ~ ffff	
B	F	DDDDD	0 ~ 65535	
W	TV	DDD	0 ~ 255	Timer Memory
W	CV	DDD	0 ~ 255	Counter Memory
W	D	DDDD	0 ~ 9999	Data Register
W	W	HHHH	0 ~ ffff	
W	R	DDDDD	0 ~ 65535	

Wiring Diagram:

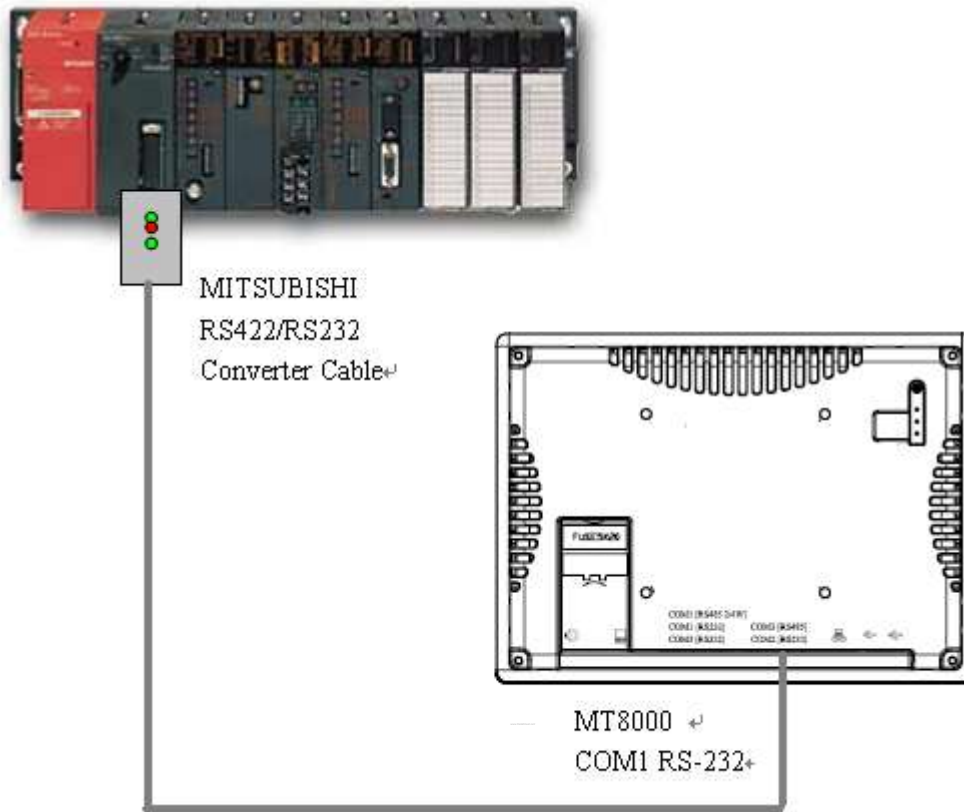

Use the RS422 to RS232 PLC programming cable (shown as follows)

MITSUBISHI AnS CPU





The following represents the view of HMI & PLC.

eMT3000 series

COM1 RS232 9P D-Sub Female	PLC Programming Converter		Mitsubishi RS422 25P D-Sub Male
2 RX	TX	TX+	2 RX+
3 TX	RX	RX+	3 TX+
5 GND	GND	DTR+	4 DSR+
7 RTS	CTS	GND	7 GND
8 CTS	RTS	TX-	15 RX-
		RX-	16 TX-
		DTR-	17 DSR-
			

MT6000/8000 series except MT6050i/MT8050i

COM1 RS232 9P D-Sub Female	PLC Programming Converter		Mitsubishi RS422 25P D-Sub Male
2 RX	TX	TX+	2 RX+
3 TX	RX	RX+	3 TX+
5 GND	GND	DTR+	4 DSR+
7 RTS	CTS	GND	7 GND
8 CTS	RTS	TX-	15 RX-
		RX-	16 TX-
		DTR-	17 DSR-
			

Driver Version:

Version	Date	Description
V1.00	Aug/12/2009	Driver released.

Mitsubishi A3A/A3N/A1SH/A2SH

Supported Series: Mitsubishi A3A,A3N,A1SH,A2SH

Website: <http://www.mitsubishi-automation.com/>

HMI Setting:

Parameters	Recommended	Options	Notes
PLC type	Mitsubishi A3A/A3N/A1SH/A2SH		
PLC I/F	RS232		
Baud rate	9600		
Data bits	8		
Parity	Odd		
Stop bits	1		
PLC sta. no.	0		

Note: This driver is not available for On-line Simulation.

Device Address:

Bit/Word	Device type	Format	Range	Memo
B	X	HHHH	0 ~ ffff	Input Relay
B	Y	HHHH	0 ~ ffff	Output Relay
B	M	DDDDD	0 ~ 65535	Auxiliary Relay
B	B	HHHH	0 ~ ffff	
B	F	DDDDD	0 ~ 65535	
W	TV	DDDDD	0 ~ 65535	Timer Memory
W	CV	DDDDD	0 ~ 65535	Counter Memory
W	D	DDDDD	0 ~ 65535	Data Register
W	W	HHHH	0 ~ ffff	
W	R	DDDDD	0 ~ 65535	

Wiring Diagram:

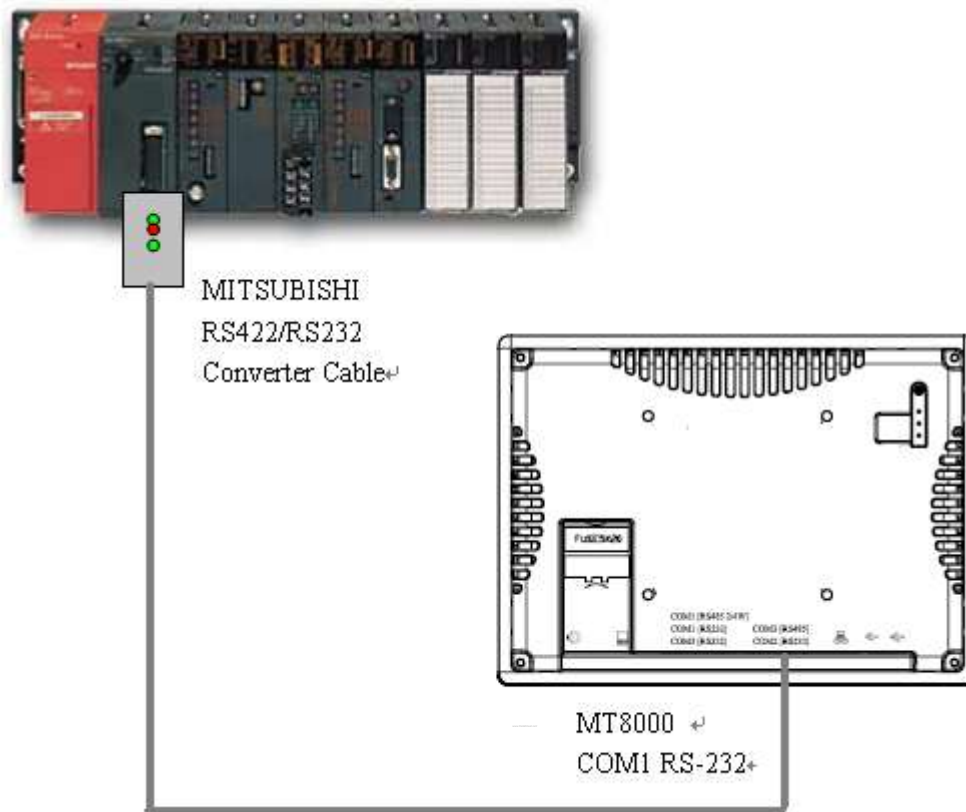

Use the RS422 to RS232 PLC programming cable (shown as follows)

MITSUBISHI AnS CPU





The following represents the view of HMI & PLC.

eMT3000 series

COM1 RS232 9P D-Sub Female	PLC Programming Converter		Mitsubishi RS422 25P D-Sub Male
2 RX	TX	TX+	2 RX+
3 TX	RX	RX+	3 TX+
5 GND	GND	DTR+	4 DSR+
7 RTS	CTS	GND	7 GND
8 CTS	RTS	TX-	15 RX-
		RX-	16 TX-
		DTR-	17 DSR-
			

MT6000/8000 series except MT6050i/MT8050i

COM1 RS232 9P D-Sub Female	PLC Programming Converter		Mitsubishi RS422 25P D-Sub Male
2 RX	TX	TX+	2 RX+
3 TX	RX	RX+	3 TX+
5 GND	GND	DTR+	4 DSR+
7 RTS	CTS	GND	7 GND
8 CTS	RTS	TX-	15 RX-
		RX-	16 TX-
		DTR-	17 DSR-
			

Driver Version:

Version	Date	Description
V1.00	Oct/20/2009	Driver released.

Mitsubishi A2US

Supported Series: Mitsubishi A2US

Website: <http://www.mitsubishi-automation.com/>

HMI Setting:

Parameters	Recommended	Options	Notes
PLC type	Mitsubishi A2US		
PLC I/F	RS232		
Baud rate	9600		
Data bits	8		
Parity	Odd		
Stop bits	1		
PLC sta. no.	0		

Device Address:

Bit/Word	Device type	Format	Range	Memo
B	X	HHHH	0 ~ 270f	Input Relay
B	Y	HHHH	0 ~ 270f	Output Relay
B	M	DDDD	0 ~ 9999	Auxiliary Relay
W	TV	DDD	0 ~ 255	Timer Memory
W	CV	DDD	0 ~ 255	Counter Memory
W	D	DDDD	0 ~ 9999	Data Register

Wiring Diagram:

Use the RS422 to RS232 PLC programming cable (shown as follows)

MITSUBISHI AnS CPU

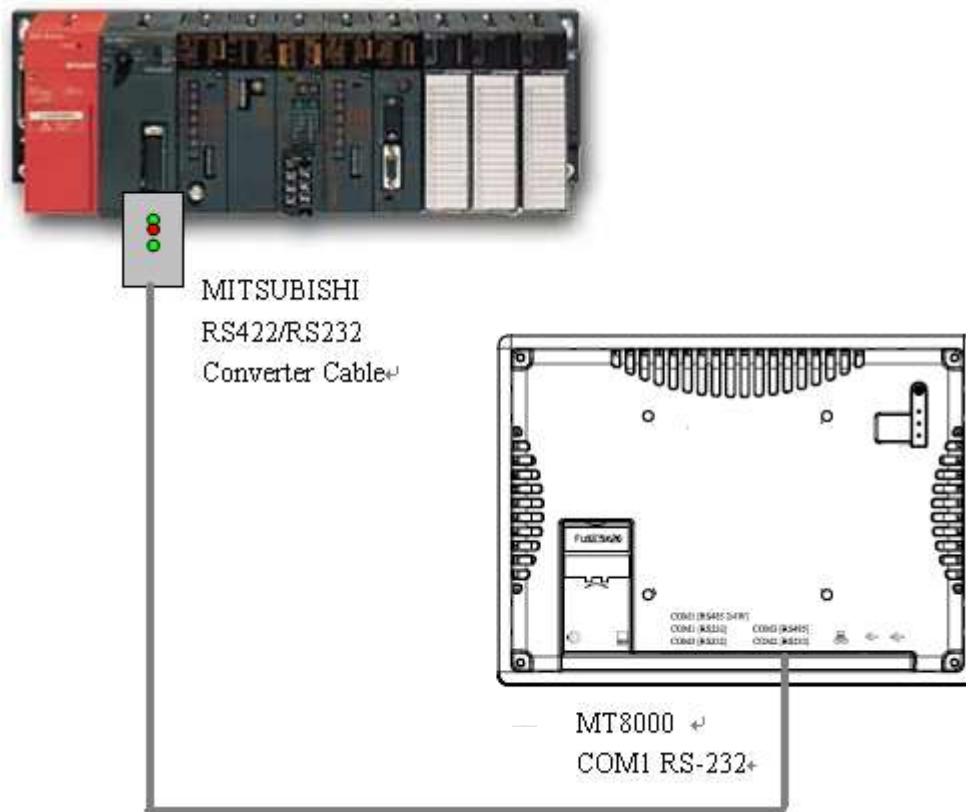



The following represents the view of HMI & PLC.

eMT3000 series

COM1 RS232 9P D-Sub Female	PLC Programming Converter		Mitsubishi RS422 25P D-Sub Male
2 RX	TX	TX+	2 RX+
3 TX	RX	RX+	3 TX+
5 GND	GND	DTR+	4 DSR+
7 RTS	CTS	GND	7 GND
8 CTS	RTS	TX-	15 RX-
		RX-	16 TX-
		DTR-	17 DSR-

MT6000/8000 series except MT6050i/MT8050i

COM1 RS232 9P D-Sub Female	PLC Programming Converter		Mitsubishi RS422 25P D-Sub Male
2 RX	TX	TX+	2 RX+
3 TX	RX	RX+	3 TX+
5 GND	GND	DTR+	4 DSR+
7 RTS	CTS	GND	7 GND
8 CTS	RTS	TX-	15 RX-
		RX-	16 TX-
		DTR-	17 DSR-
			

Driver Version:

Version	Date	Description
V1.00	Mar/20/2009	Driver released.

Mitsubishi AJ71

Supported Series: Mitsubishi A series PLC with AJ71C24 communication module using the Computer Link protocol.

Website: <http://www.mitsubishi-automation.com>

HMI Setting:

Parameters	Recommended	Options	Notes
PLC type	Mitsubishi AJ71	Mitsubishi AJ71 (AnA/AnU CPU), Mitsubishi AJ71 (Format 4)	
PLC I/F	RS485 4W	RS485 4W, RS232	
Baud rate	19200	9600, 19200	
Data bits	8	8	
Parity	Even	Even, Odd, None	
Stop bits	1	1	
PLC sta. no.	0	—	

PLC Setting:

Communication mode	Computer Link protocol 9600, Even, 8, 1 (default)
Mode setting switch	Format 1
Parity check	Enable
Sum check	Enable

Device Address:

Bit/Word	Device type	Format	Range	Memo
B	X	HHHH	0 ~ ffff	Input Bits
B	Y	HHHH	0 ~ ffff	Output Bits
B	M	DDDDD	0 ~ 65535	Internal Relays
B	T	DDDDD	0 ~ 65535	
B	C	DDDDD	0 ~ 65535	
B	B	HHHH	0 ~ ffff	



Bit/Word	Device type	Format	Range	Memo
B	F	DDDDD	0 ~ 65535	
W	TV	DDDDD	0 ~ 65535	Timer Preset Value
W	CV	DDDDD	0 ~ 65535	Counter Preset Value
W	D	DDDDD	0 ~ 65535	Data Registers
W	W	HHHH	0 ~ ffff	
W	R	DDDDD	0 ~ 65535	

Wiring Diagram:



The following represents the view of HMI & PLC.

AJ71C24 RS422



eMT3000 series

COM1 RS485 4W 9P D-Sub Male			AJ71C24 RS422 Terminal
1 RX-			SDB
2 RX+			SDA
3 TX-			RDB
4 TX+			RDA
5 GND			GND
			

MT6000/8000 series except MT6050i/MT8050i

COM1 RS485 4W 9P D-Sub Male			AJ71C24 RS422 Terminal
1 RX-			SDB
2 RX+			SDA
3 TX-			RDB
4 TX+			RDA
5 GND			GND
			



MT6050i/MT8050i

COM1 RS485 4W 9P D-Sub Female			AJ71C24 RS422 Terminal
1 RX-			SDB
2 RX+			SDA
3 TX-			RDB
4 TX+			RDA
5 GND			GND
			





The following represents the view of HMI & PLC.

A1SJ71UC24-R2



eMT3000 series

COM1 RS232 9P D-Sub Female	COM3 RS232 9P D-Sub Female		RS232 9P D-Sub Male
2 RX	8 RX		3 TXD
3 TX	7 TX		2 RXD
5 GND	5 GND		5 GND
			1 DCD
			4 DTR
			6 DSR
			7 RTS
			8 CTS
			circuit
			circuit
			

MT6000/8000 series except MT6050i/MT8050i

COM1 RS232 9P D-Sub Female	COM2 RS232 9P D-Sub Female	COM3 RS232 9P D-Sub Male	RS232 9P D-Sub Male
2 RX	6 RX	8 RX	3 TXD
3 TX	4 TX	7 TX	2 RXD
5 GND	5 GND	5 GND	5 GND
			1 DCD
			4 DTR
			6 DSR
			7 RTS
			8 CTS
			circuit
			circuit
			

MT6050i/MT8050i

COM1 RS232 9P D-Sub Female			RS232 9P D-Sub Male
9 RX			3 TXD
6 TX			2 RXD
5 GND			5 GND
			1 DCD
			4 DTR
			6 DSR
			7 RTS
			8 CTS
			circuit
			circuit
			

Driver Version:

Version	Date	Description
V1.50	Mar/11/2010	

Mitsubishi AJ71 (AnA/AnU CPU)

Supported Series: Mitsubishi AJ71 (AnA/AnU CPU)

Website: <http://www.mitsubishi-automation.com>

HMI Setting:

Parameters	Recommended	Options	Notes
PLC type	Mitsubishi AJ71 (AnA/AnU CPU)		
PLC I/F	RS485 4W	RS485 4W, RS232	
Baud rate	19200	9600, 19200	
Data bits	8	8	
Parity	Even	Even, Odd, None	
Stop bits	1	1	
PLC sta. no.	0		

PLC Setting:

Communication mode	Computer Link protocol 9600, Even, 8, 1 (default)
Mode setting switch	Format 1
Parity check	Enable
Sum check	Enable



Device Address:

Bit/Word	Device type	Format	Range	Memo
B	X	HHHH	0 ~ ffff	Input Bits
B	Y	HHHH	0 ~ ffff	Output Bits
B	M	DDDDD	0 ~ 65535	Internal Relays
B	T	DDDDD	0 ~ 65535	
B	C	DDDDD	0 ~ 65535	
B	B	HHHH	0 ~ ffff	
B	F	DDDDD	0 ~ 65535	
W	TV	DDDDD	0 ~ 65535	Timer Preset Value
W	CV	DDDDD	0 ~ 65535	Counter Preset Value
W	D	DDDDD	0 ~ 65535	Data Registers
W	W	HHHH	0 ~ ffff	
W	R	DDDDD	0 ~ 65535	



Wiring Diagram:

The following represents the view of HMI & PLC.



eMT3000 series

COM1 RS485 4W 9P D-Sub Male			RS422 Terminal
1 RX-			SDB
2 RX+			SDA
3 TX-			RDB
4 TX+			RDA
5 GND			GND
			

MT6000/8000 series except MT6050i/MT8050i



COM1 RS485 4W 9P D-Sub Male			RS422 Terminal
1 RX-			SDB
2 RX+			SDA
3 TX-			RDB
4 TX+			RDA
5 GND			GND
			

MT6050i/MT8050i





COM1 RS485 4W 9P D-Sub Female			RS422 Terminal
1 RX-			SDB
2 RX+			SDA
3 TX-			RDB
4 TX+			RDA
5 GND			GND
			

The following represents the view of HMI & PLC.



eMT3000 series

COM1 RS232 9P D-Sub Female	COM3 RS232 9P D-Sub Female		RS232 9P D-Sub Male
2 RX	8 RX		3 TXD
3 TX	7 TX		2 RXD
5 GND	5 GND		5 GND
			1 DCD
			4 DTR
			6 DSR
			7 RTS
			8 CTS
			circuit
			circuit
			

MT6000/8000 series except MT6050i/MT8050i

COM1 RS232 9P D-Sub Female	COM2 RS232 9P D-Sub Female	COM3 RS232 9P D-Sub Male	RS232 9P D-Sub Male
2 RX	6 RX	8 RX	3 TXD
3 TX	4 TX	7 TX	2 RXD
5 GND	5 GND	5 GND	5 GND
			1 DCD
			4 DTR
			6 DSR
			7 RTS
			8 CTS
			circuit
			circuit
			

MT6050i/MT8050i

COM1 RS232 9P D-Sub Female			RS232 9P D-Sub Male
9 RX			3 TXD
6 TX			2 RXD
5 GND			5 GND
			1 DCD
			4 DTR
			6 DSR
			7 RTS
			8 CTS
			circuit
			circuit
			

Driver Version:

Version	Date	Description
V1.00	Oct/31/2011	Driver released.

Mitsubishi AJ71 (Format 4)

Supported Series: Mitsubishi A series PLC with AJ71C24 communication module using the Computer Link protocol.

Website: <http://www.mitsubishi-automation.com>

HMI Setting:

Parameters	Recommended	Options	Notes
PLC type	Mitsubishi AJ71 (Format 4)		
PLC I/F	RS485 4W	RS485 4W, RS232	
Baud rate	19200	9600, 19200	
Data bits	8	8	
Parity	Even	Even, Odd, None	
Stop bits	1	1	
PLC sta. no.	0		

PLC Setting:

Communication mode	Computer Link protocol 9600, Even, 8, 1 (default)
Mode setting switch	Format 4
Parity check	Enable
Sum check	Enable



Device Address:

Bit/Word	Device type	Format	Range	Memo
B	X	HHHH	0 ~ ffff	Input Bits
B	Y	HHHH	0 ~ ffff	Output Bits
B	M	DDDDD	0 ~ 65535	Internal Relays
B	T	DDDDD	0 ~ 65535	
B	C	DDDDD	0 ~ 65535	
B	B	HHHH	0 ~ ffff	
B	F	DDDDD	0 ~ 65535	
W	TV	DDDDD	0 ~ 65535	Timer Preset Value
W	CV	DDDDD	0 ~ 65535	Counter Preset Value
W	D	DDDDD	0 ~ 65535	Data Registers
W	W	HHHH	0 ~ ffff	
W	R	DDDDD	0 ~ 65535	



Wiring Diagram:

The following represents the view of HMI & PLC.



eMT3000 series

COM1 RS485 4W 9P D-Sub Male			AJ71C24 RS422 Terminal
1 RX-			SDB
2 RX+			SDA
3 TX-			RDB
4 TX+			RDA
5 GND			GND
			

MT6000/8000 series except MT6050i/MT8050i

COM1 RS485 4W 9P D-Sub Male			AJ71C24 RS422 Terminal
1 RX-			SDB
2 RX+			SDA
3 TX-		—	RDB
4 TX+			RDA
5 GND			GND
			



MT6050i/MT8050i

COM1 RS485 4W 9P D-Sub Female			AJ71C24 RS422 Terminal
1 RX-			SDB
2 RX+			SDA
3 TX-			RDB
4 TX+			RDA
5 GND			GND
			





The following represents the view of HMI & PLC.

A1SJ71UC24-R2



eMT3000 series

COM1 RS232 9P D-Sub Female	COM3 RS232 9P D-Sub Female		RS232 9P D-Sub Male
2 RX	8 RX		3 TXD
3 TX	7 TX		2 RXD
5 GND	5 GND		5 GND
			1 DCD
			4 DTR
			6 DSR
			7 RTS
			8 CTS
			circuit
			circuit
			

MT6000/8000 series except MT6050i/MT8050i

COM1 RS232 9P D-Sub Female	COM2 RS232 9P D-Sub Female	COM3 RS232 9P D-Sub Male	RS232 9P D-Sub Male
2 RX	6 RX	8 RX	3 TXD
3 TX	4 TX	7 TX	2 RXD
5 GND	5 GND	5 GND	5 GND
			1 DCD
			4 DTR
			6 DSR
			7 RTS
			8 CTS
			circuit
			circuit
			

MT6050i/MT8050i

COM1 RS232 9P D-Sub Female			RS232 9P D-Sub Male
9 RX			3 TXD
6 TX			2 RXD
5 GND			5 GND
			1 DCD
			4 DTR
			6 DSR
			7 RTS
			8 CTS
			circuit
			circuit
			

Driver Version:

Version	Date	Description
V1.00	Mar/08/2010	

Mitsubishi F930GOT Server

Supported Series: F930GOT general-purpose communication Type 1.

HMI Setting:

Parameters	Recommended	Options	Notes
PLC type	F930GOT Server		
PLC I/F	RS232		
Baud rate	38400	9600, 115200	
Data bits	8	7 or 8	
Parity	None	Even, Odd, None	
Stop bits	1	1 or 2	
PLC sta. no.	1		

Device Address:



Bit/Word	Device type	Format	Range	Memo
B	RB	DDDD	0 ~ 2047	
W	RW	DDDDD	0 ~ 65535	

Note: In PLC name drop - down menu don't select F930GOT Server.
Please select Local HMI, Device Type=RW.





Wiring Diagram:

The following represents the view of HMI & PLC.



eMT3000 series

COM1 RS232 9P D-Sub Female	COM3 RS232 9P D-Sub Female		Micro Computer Board RS232 Female
2 RX	8 RX		3 TD
3 TX	7 TX		2 RD
5 GND	5 GND		5 GND
			

MT6000/8000 series except MT6050i/MT8050i

COM1 RS232 9P D-Sub Female	COM2 RS232 9P D-Sub Female	COM3 RS232 9P D-Sub Male	Micro Computer Board RS232 Female
2 RX	6 RX	8 RX	3 TD
3 TX	4 TX	7 TX	2 RD
5 GND	5 GND	5 GND	5 GND
			

MT6050i/MT8050i

COM1 RS232 9P D-Sub Female			Micro Computer Board RS232 Female
9 RX			3 TD
6 TX			2 RD
5 GND			5 GND
			

Protocol:

Read Command:

PC → HMI

02	'0'	Read address	Size	CR
----	-----	--------------	------	----

02	30	30	30	30	30	30	32	0D
----	----	----	----	----	----	----	----	----

Read RW0 1 word (2 bytes) STX = 0x02, '0' = Read command, CR = 0x0D

Read address (hexadecimal)

0 ~ FFFF = RW0 ~ 65535

Size (hexadecimal)

2 ~ FE = 2 ~ 254 bytes = 1 ~ 127 word.

Size must be even.

HMI → PC (response)

02	Data1	Data2	CR
----	-------	-------	-------	----

02	30	30	31	30	0D
----	----	----	----	----	----

RW0 = 0x0010 = 16

Write Command:

PC → HMI

02	'1'	Read address	Size	Data1	Data2	CR
----	-----	--------------	------	-------	-------	-------	----

02	31	30	30	30	30	30	32	12	34	0D
----	----	----	----	----	----	----	----	----	----	----

Write RW0 = 0x1234

Read address (hexadecimal)

0 ~ FFFF = RW0 ~ 65535

Size (hexadecimal)

2 ~ FE = 2 ~ 254 bytes = 1 ~ 127 word.

Size must be even.

HMI → PC (response)

06

ACK = 0x06

Driver Version:

Version	Date	Description
V1.00	Aug/14/2009	Driver released.

Mitsubishi FX0s/FX0n/FX1s/FX1n/FX2

Supported Series: Mitsubishi FX0s/FX0n/FX1s/FX1n/FX2 PLC

Website: <http://www.mitsubishi-automation.com>

HMI Setting:

Parameters	Recommended	Options	Notes
PLC type	Mitsubishi FX0s/FX0n/FX1s/FX1n/FX2		
PLC I/F	RS485 4W	RS232/RS485	
Baud rate	9600	9600/19200/38400/ 57600/115200	
Data bits	7	7,8	
Parity	Even	Even, Odd, None	
Stop bits	1	1,2	
PLC sta. no.	0	0-255	



Device Address:

Bit/Word	Device type	Format	Range	Memo
B	X	OOO	0 ~ 377	Input Relay
B	Y	OOO	0 ~ 377	Output Relay
B	M	DDDD	0 ~ 9999	Auxiliary Relay
B	T	DDD	0 ~ 255	Timer Relay
B	C	DDD	0 ~ 255	Counter Relay
B	SM	DDDD	8000 ~ 9999	Special Aux. Relays
B	D_Bit	DDDDdd	0 ~ 999915	Data Register Bit (D)
B	S	DDDD	0 ~ 4095	States
W	TV	DDD	0 ~ 255	Timer Memory
W	CV	DDD	0 ~ 199	Counter Memory
W	D	DDDD	0 ~ 9999	Data Register
DW	CV2	DDD	200 ~ 255	Counter Memory(D Word)
W	SD	DDDD	8000 ~ 9999	Special Data Register



Wiring Diagram:

The following represents the view of HMI & PLC.



eMT3000 series

COM1 RS485 4W 9P D-Sub Male			RS422 Port 8P Mini-DIN Male
1 RX-			4 TX-
2 RX+			7 TX+
3 TX-			1 RX-
4 TX+			2 RX+
5 GND			3 GND
			

MT6000/8000 series except MT6050i/MT8050i

COM1 RS485 4W 9P D-Sub Male			RS422 Port 8P Mini-DIN Male
1 RX-			4 TX-
2 RX+			7 TX+
3 TX-		—	1 RX-
4 TX+			2 RX+
5 GND			3 GND
			



MT6050i/MT8050i

COM1 RS485 4W 9P D-Sub Female			RS422 Port 8P Mini-DIN Male
1 RX-			4 TX-
2 RX+			7 TX+
3 TX-			1 RX-
4 TX+			2 RX+
5 GND			3 GND
			



The following represents the view of HMI & PLC..

9P D-Sub to 25P D-Sub:



eMT3000 series

COM1 RS485 4W 9P D-Sub Male			RS422 Port 25P Mini-DIN Male
1 RX-			16 TXD-
2 RX+			3 TXD+
3 TX-			15 RXD-
4 TX+			2 RXD+
5 GND			7 GND
			4 DSR+
			8 GND
			13 +5V
			17 DSR-
			circuit
			circuit
			

MT6000/8000 series except MT6050i/MT8050i

COM1 RS485 4W 9P D-Sub Male			RS422 Port 25P Mini-DIN Male
1 RX-			16 TXD-
2 RX+			3 TXD+
3 TX-			15 RXD-
4 TX+			2 RXD+
5 GND			7 GND
			4 DSR+
			8 GND
			13 +5V
			17 DSR-
			circuit
			circuit
			

MT6050i/MT8050i

COM1 RS485 4W 9P D-Sub Female			RS422 Port 25P Mini-DIN Male
1 RX-			16 TXD-
2 RX+			3 TXD+
3 TX-			15 RXD-
4 TX+			2 RXD+
5 GND			7 GND
			4 DSR+
			8 GND
			13 +5V
			17 DSR-
			circuit
			circuit
			

Driver Version:

Version	Date	Description
V1.20	Oct/26/2011	

Mitsubishi FX232/485BD

Supported Series: Mitsubishi FX0n/FX2/FX2n COM for Communication Module BD
 FX2N-485-BD, FX2N-232-BD, FX1N-485-BD, FX1N-232-BD & FX3U-485ADP.

Website: <http://www.mitsubishi-automation.com>

HMI Setting:

Parameters	Recommended	Options	Notes
PLC type	Mitsubishi FX232/485BD		
PLC I/F	RS232/RS485	RS232/RS485 2w/4w	in accordance with the BD module
Baud rate	19200	9600/19200/38400	
Data bits	7	7,8	
Parity	Even	Even, Odd, None	
Stop bits	1	1,2	
PLC sta. no.	1	0-15	

Note: It is recommended to set turn around delay to 8. (For RS485 2W)

Online simulator	YES	Extend address mode	YES
------------------	-----	---------------------	-----

PLC Setting:

Communication mode	Must set PLC station when using BD Module.
--------------------	--

Register D8120 setting: set b9 and b8 of BFM#0 to 0.

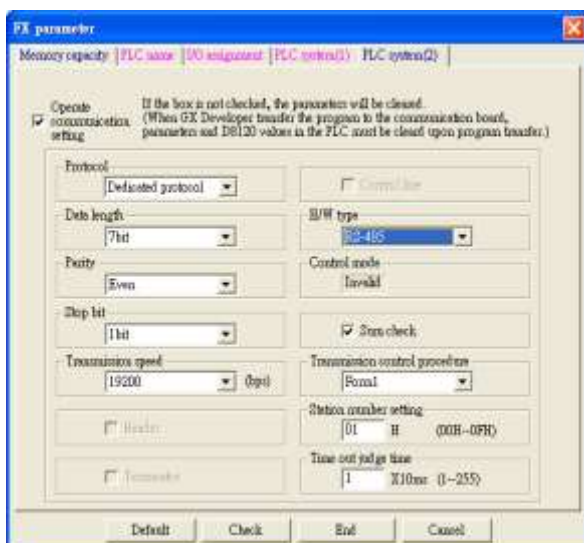

FX2N-485-BD, FX1N-485-BD

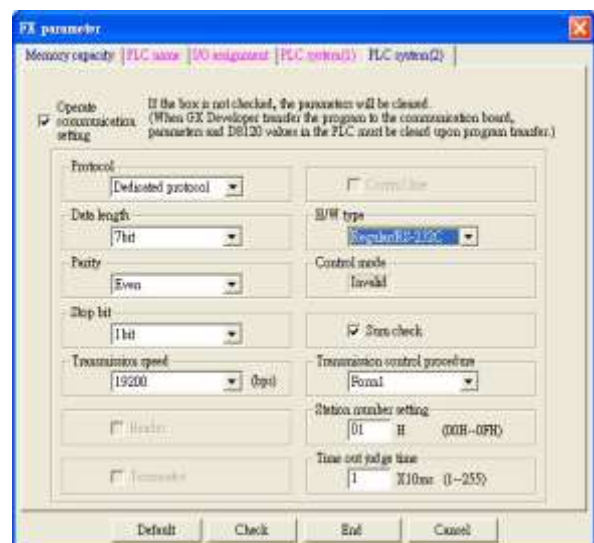

FX2N-232-BD, FX1N-232-BD

Device Address:



Bit/Word	Device type	Format	Range	Memo
B	X	OOO	0 ~ 377	Input Relay
B	Y	OOO	0 ~ 377	Output Relay
B	M	DDDD	0 ~ 7999	Auxiliary Relay
B	T	DDD	0 ~ 511	Timer Relay
B	C	DDD	0 ~ 255	Counter Relay
B	SM	DDDD	8000 ~ 9999	Special Auxiliary Relay
B	D_Bit	DDDDh	0 ~ 7999f	Data Register Bit
B	S	DDDD	0 ~ 4095	State Relay
W	TV	DDD	0 ~ 511	Timer Memory
W	CV	DDD	0 ~ 199	Counter Memory
W	D	DDDD	0 ~ 7999	Data Register
W	CV2	DDD	200 ~ 255	Counter Memory(D Word)
W	SD	DDDD	8000 ~ 9999	Special Data Register
W	R	DDDDD	0 ~ 32767	Extended Register

Wiring Diagram:



The following represents the view of HMI & PLC.

9P D-Sub to 9P D-Sub: Communication Module RS232BD

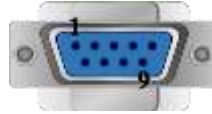

eMT3000 series

COM1 RS232 9P D-Sub Female	COM3 RS232 9P D-Sub Female		RS232 9P D-Sub Male
2 RX	8 RX		3 TXD
3 TX	7 TX		2 RXD
5 GND	5 GND		5 GND
			

MT6000/8000 series except MT6050i/MT8050i

COM1 RS232 9P D-Sub Female	COM2 RS232 9P D-Sub Female	COM3 RS232 9P D-Sub Male	RS232 9P D-Sub Male
2 RX	6 RX	8 RX	3 TXD
3 TX	4 TX	7 TX	2 RXD
5 GND	5 GND	5 GND	5 GND
			



MT6050i/MT8050i

COM1 RS232 9P D-Sub Female			RS232 9P D-Sub Male
9 RX			3 TXD
6 TX			2 RXD
5 GND			5 GND
			



The following represents the view of HMI & PLC.

Communication Module RS485BD: RS485 4W



eMT3000 series

COM1 RS485 4W 9P D-Sub Male			485BD Module 5P Terminal
1 RX-			SDB
2 RX+			SDA
3 TX-			RDB
4 TX+			RDA
5 GND			SG
			

MT6000/8000 series except MT6050i/MT8050i

COM1 RS485 4W 9P D-Sub Male			485BD Module 5P Terminal
1 RX-			SDB
2 RX+			SDA
3 TX-			RDB
4 TX+			RDA
5 GND			SG
			



MT6050i/MT8050i

COM1 RS485 4W 9P D-Sub Female			485BD Module 5P Terminal
1 RX-			SDB
2 RX+			SDA
3 TX-			RDB
4 TX+			RDA
5 GND			SG
			



The following represents the view of HMI & PLC.

Communication Module RS485BD: RS485 2W



eMT3000 series

COM1 RS485 2W 9P D-Sub Male	COM3 RS485 2W 9P D-Sub Male		485BD Module 5P Terminal
1 RX-	6 Data-		SDB
			RDB
2 RX+	9 Data+		SDA
			RDA
5 GND	5 GND		SG
			

MT6000/8000 series except MT6050i/MT8050i

COM1 RS485 2W 9P D-Sub Male	COM3 RS485 2W 9P D-Sub Male		485BD Module 5P Terminal	
1 RX-	6 Data-		SDB	circuit
			RDB	
2 RX+	9 Data+		SDA	circuit
			RDA	
5 GND	5 GND		SG	
				

MT6050i/MT8050i

COM1 RS485 2W 9P D-Sub Female	COM3 RS485 2W 9P D-Sub Female		485BD Module 5P Terminal	
1 RX-	7 Data-		SDB	circuit
			RDB	
2 RX+	8 Data+		SDA	circuit
			RDA	
5 GND	5 GND		SG	
				

Driver Version:

Version	Date	Description
V1.40	Jul/26/2011	Added registers: D_Bit and S.
V1.50	Sep/10/2012	Added register: R.

Mitsubishi FX2n

Supported Series: Mitsubishi FX1n/FX2n series PLC

Website <http://www.mitsubishi-automation.com>

HMI Setting:

Parameters	Recommended	Options	Notes
PLC type	Mitsubishi FX2n		
PLC I/F	RS485 4W	RS232/RS485	
Baud rate	19200	9600/19200/38400	
Data bits	7		
Parity	Even		
Stop bits	1		
PLC sta. no.	0		

Online simulator	YES	Extend address mode	NO
------------------	-----	---------------------	----

Device Address:



Bit/Word	Device type	Format	Range	Memo
B	X	OOO	0 ~ 377	Input Relay
B	Y	OOO	0 ~ 377	Output Relay
B	M	DDDD	0 ~ 7999	Auxiliary Relay
B	T	DDD	0 ~ 255	Timer Relay
B	C	DDD	0 ~ 255	Counter Relay
B	SM	DDDD	8000 ~ 9999	Special Auxiliary Relay
B	D_Bit	DDDDdd	0 ~ 799915	Data Register Bit (D)
B	S	DDDD	0 ~ 4095	State Relay (S)
W	TV	DDD	0 ~ 255	Timer Memory
W	CV	DDD	0 ~ 199	Counter Memory
W	D	DDDD	0 ~ 7999	Data Register
DW	CV2	DDD	200 ~ 255	Counter Memory(D Word)
W	SD	DDDD	8000 ~ 9999	Special Data Register

Wiring Diagram:



The following represents the view of HMI & PLC.

Mitsubishi FX series



eMT3000 series

COM1 RS485 4W 9P D-Sub Male			RS422 8P Mini-DIN Male
1 RX-			4 TX-
2 RX+			7 TX+
3 TX-			1 RX-
4 TX+			2 RX+
5 GND			3 GND
			

MT6000/8000 series except MT6050i/MT8050i

COM1 RS485 4W 9P D-Sub Male			RS422 8P Mini-DIN Male
1 RX-			4 TX-
2 RX+		—	7 TX+
3 TX-			1 RX-
4 TX+			2 RX+
5 GND			3 GND
			

MT6050i/MT8050i

COM1 RS485 4W 9P D-Sub Female			RS422 8P Mini-DIN Male
1 RX-			4 TX-
2 RX+			7 TX+
3 TX-			1 RX-
4 TX+			2 RX+
5 GND			3 GND
			

Driver Version:

Version	Date	Description
V1.60	Sep/10/2009	

Mitsubishi FX3u (Ethernet)

Supported Series: Mitsubishi FX SERIES, Module: FX3U-ENET.

Website: <http://www.mitsubishi-automation.com>

HMI Setting:

Parameters	Recommended	Options	Notes
PLC type	Mitsubishi FX3u (Ethernet)		
PLC I/F	Ethernet		
Port no.	5001(default)		Refer to Module Setting
PLC sta. no.	0 (default)		Refer to Module Setting

PLC Setting:

Fx3u-ENET module setting:

Before using Ethernet module, use GX Developer / FX Configurator-EN to set the Ethernet module, the FX3u-ENET module setting steps are shown below.

Step1. Open GX Developer, select “Read from PLC” in Online list.

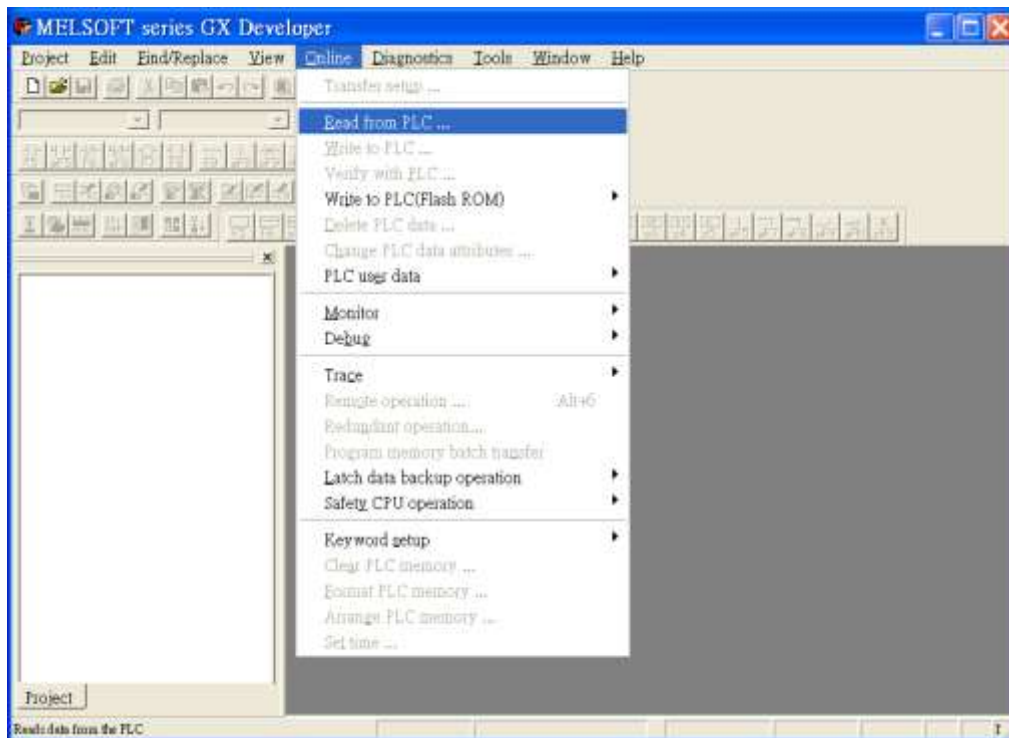

Step2. Select "FXCPU" in PLC series.

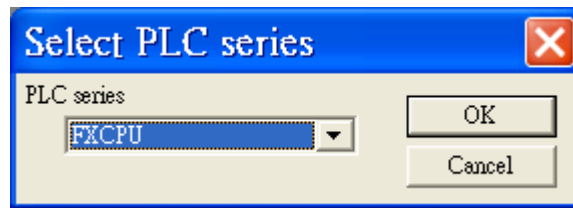

Step3. Connect PLC via serial port for setting IP address first.

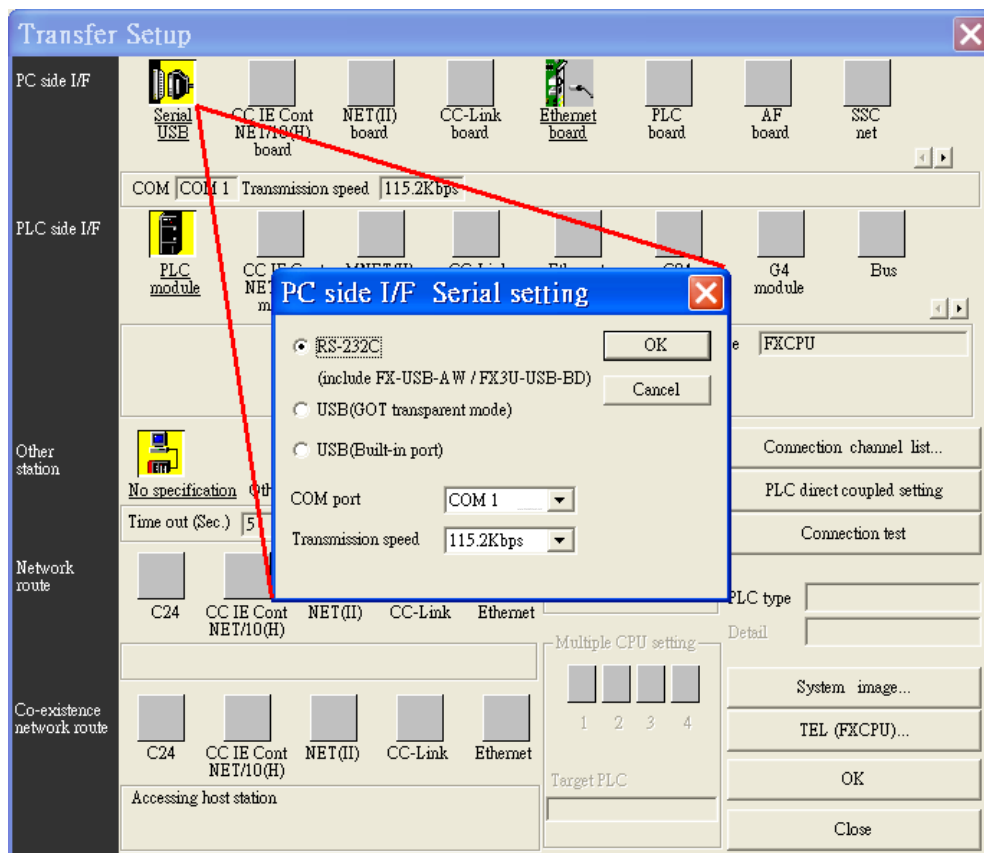

Step4. After finishing the PLC settings, select Tools/FX special function utility/FX Configurator-EN.

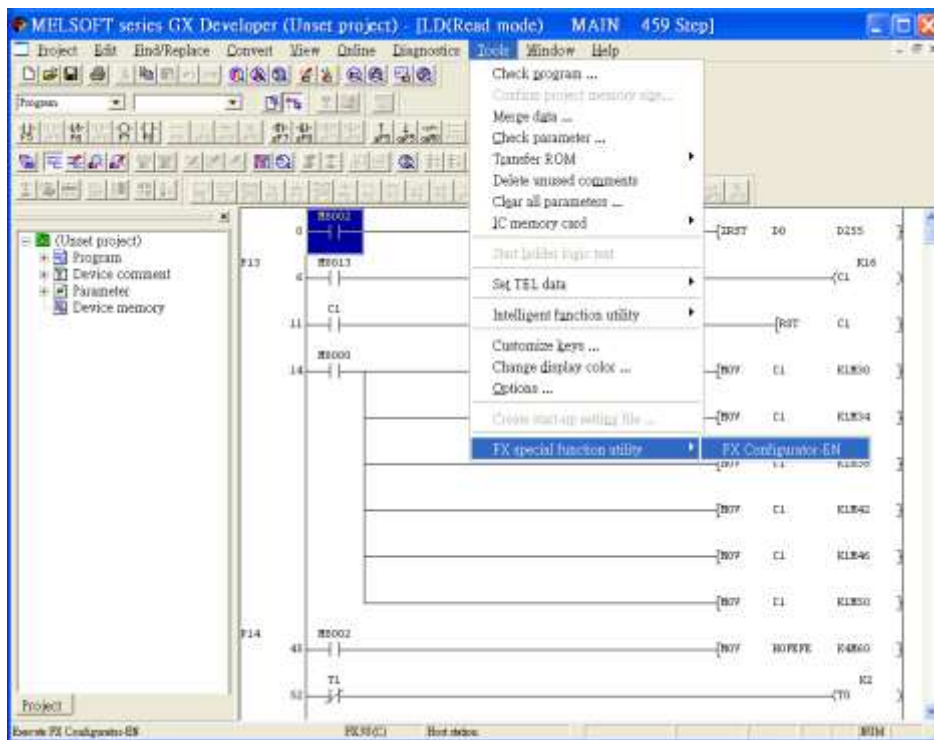

Step5. Select “Module 0” in Ethernet Module settings.
(If more than one module needed, please set modules step by step)

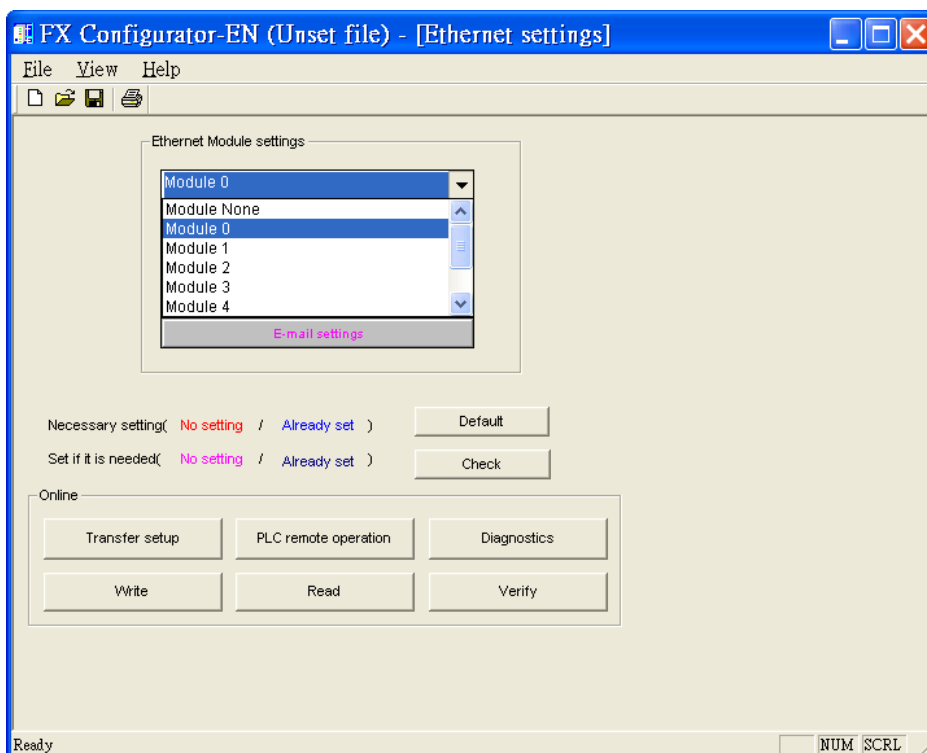

Step6. In Ethernet operational settings, select the related parameters and IP address and then press "End" to finish setting.

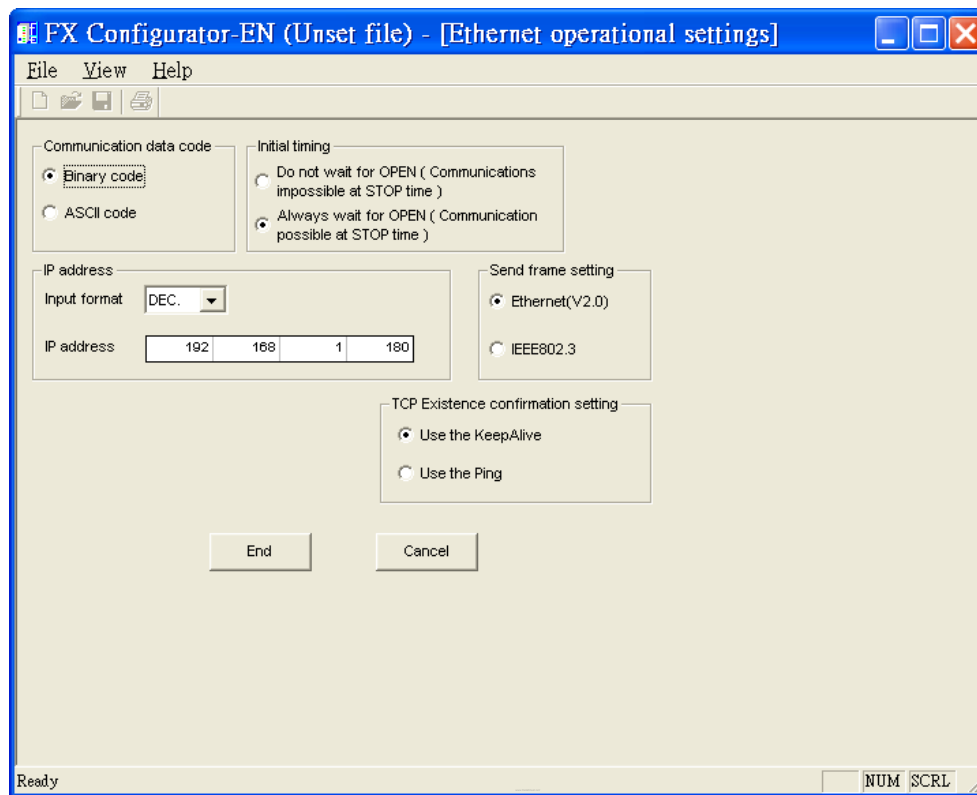

Step7. In Ethernet open settings, press "End" after setting the parameters below.

1	TCP	MELSOFT connection						
2	TCP	Unpassive	Send	Procedure exist(MC)	Disable	No confirm	5001	
3	TCP	Unpassive	Send	Procedure exist(MC)	Disable	No confirm	5001	
4	TCP	Unpassive	Send	Procedure exist(MC)	Disable	No confirm	5001	

(The first Protocol means using GX Developer to communicate with module, the max. "Fixed buffer communication procedure" is 4 units.)

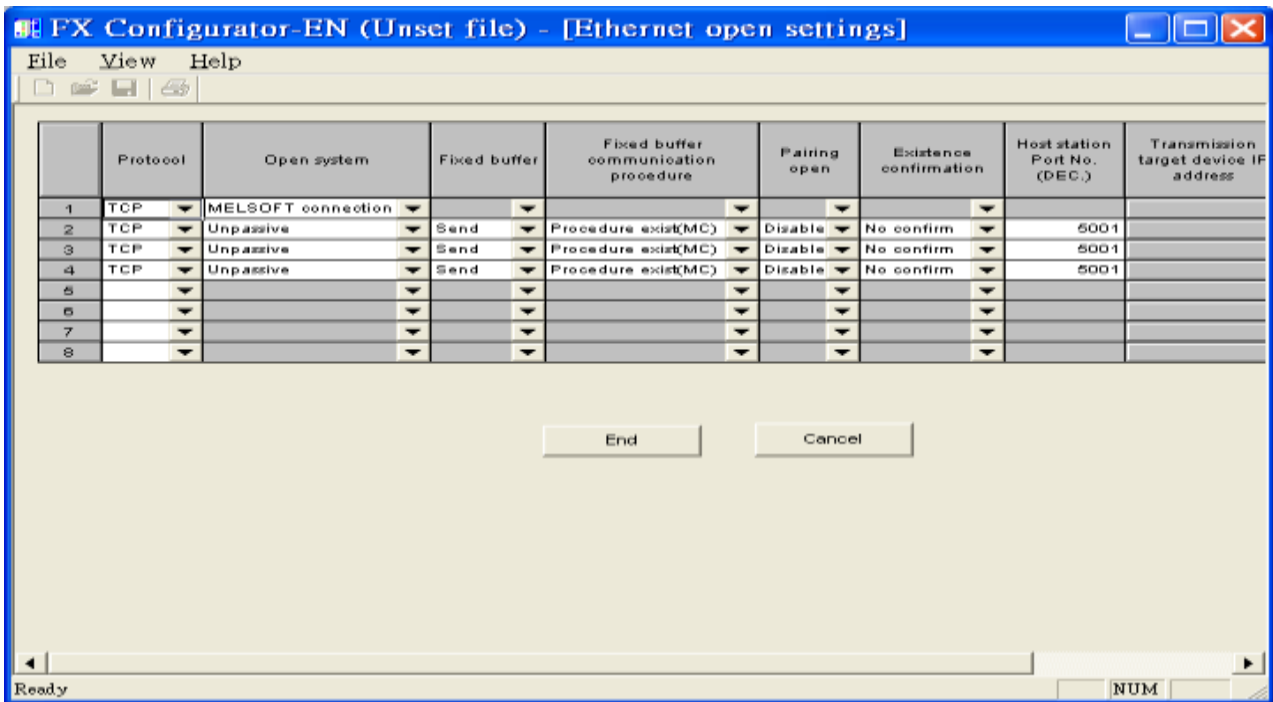

Or

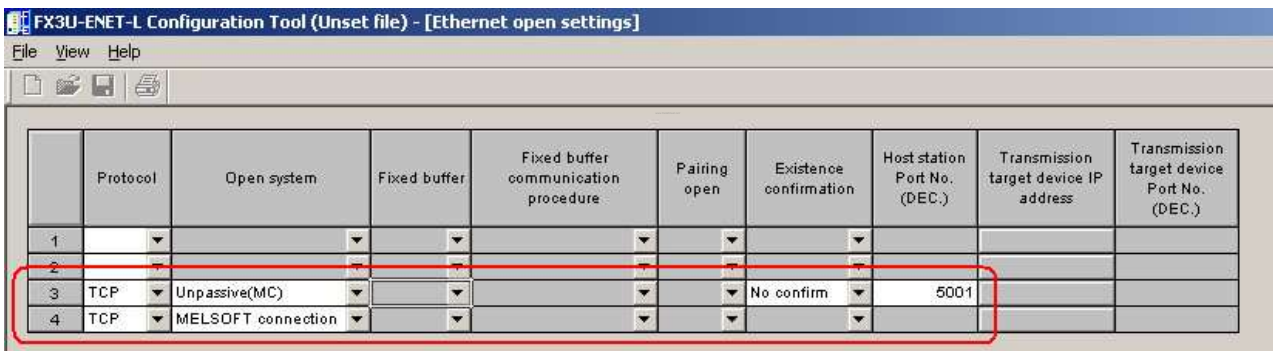

Step8. After setting the parameters of PLC, restart for Ethernet communication.

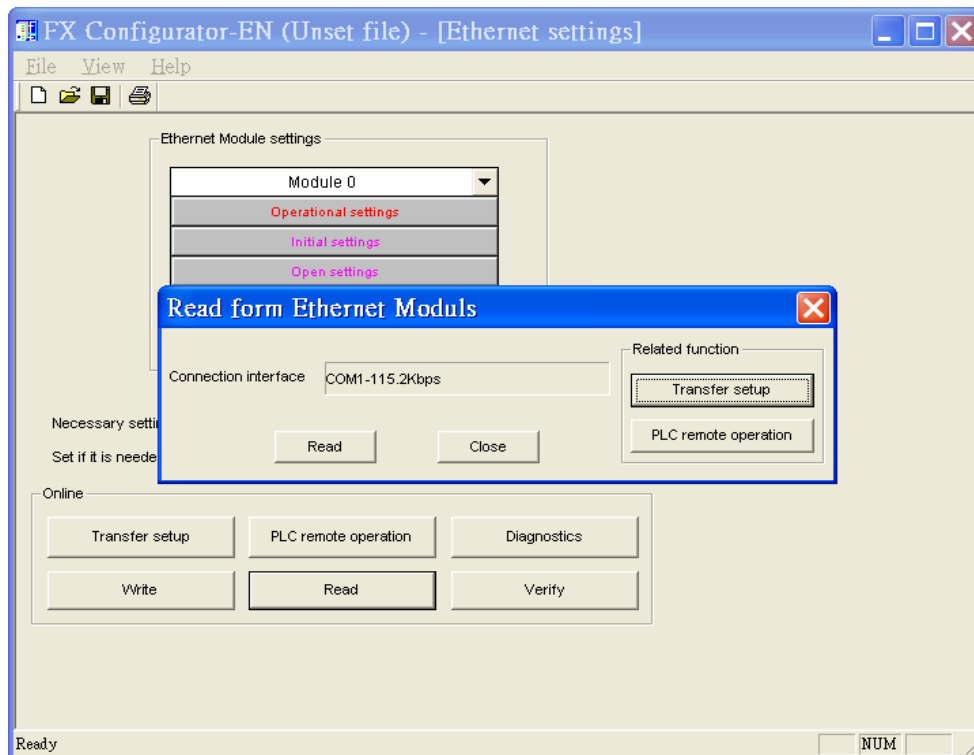

Device Address:

Bit/Word	Device type	Format	Range	Memo
B	X	OOO	0 ~ 571	Input
B	Y	OOO	0 ~ 571	Output Relay
B	M	DDDD	0 ~ 7999	Internal Relay
B	T	DDD	0 ~ 511	Timer Contacts
B	C	DDD	0 ~ 255	Counter Contacts
B	SM	DDDD	8000 ~ 8511	Special Int. Relays
B	D_Bit	DDDDDdd	0 ~ 1799915	Data Register Bit Access
B	S	DDDD	0 ~ 4095	Step Relays
W	TV	DDD	0 ~ 511	Timer Value
W	CV	DDD	0 ~ 199	Counter Value
W	D	DDDD	0 ~ 7999	Data Registers
W	CV2	DDD	200 ~255	Counter Value
W	SD	DDDD	8000 ~ 8511	Special Data Registers
W	R	DDDDD	0 ~ 32767	File Register

Wiring Diagram:

Direct connect (crossover cable):

HMI RJ45 Male	Wire Color	Wire Color	PLC RJ45 Male
1 TX+	White/Orange	White/Green	3 RX+
2 TX-	Orange	Green	6 RX-
3 RX+	White/Green	White/Orange	1 TX+
4 BD4+	Blue	Blue	4 BD4+
5 BD4-	White/Blue	White/Blue	5 BD4-
6 RX-	Green	Orange	2 TX-
7 BD3+	White/Brown	White/Brown	7 BD3+
8 BD3-	Brown	Brown	8 BD3-



Through a hub:

HMI RJ45 Male	Wire Color	Wire Color	PLC RJ45 Male
1 TX+	White/Orange	White/Orange	1 TX+
2 TX-	Orange	Orange	2 TX-
3 RX+	White/Green	White/Green	3 RX+
4 BD4+	Blue	Blue	4 BD4+
5 BD4-	White/Blue	White/Blue	5 BD4-
6 RX-	Green	Green	6 RX-
7 BD3+	White/Brown	White/Brown	7 BD3+
8 BD3-	Brown	Brown	8 BD3-



Driver Version:

Version	Date	Description
V1.00	Feb/12/2009	Driver released.

Mitsubishi FX3u/FX3G

Supported Series: Mitsubishi FX3U/FX3UC/FX3G.

Website: <http://www.mitsubishi-automation.com>

HMI Setting:

Parameters	Recommended	Options	Notes
PLC type	Mitsubishi FX3u/FX3G		
PLC I/F	RS485 4w	RS232/RS485	
Baud rate	38400	9600/19200	
Data bits	7		
Parity	Even		
Stop bits	1		
PLC sta. no.	0		Does not apply to this protocol

Online simulator	YES (9600 baud rate only)	Extend address mode	NO
------------------	---------------------------	---------------------	----



Device Address:

Bit/Word	Device type	Format	Range	Memo
B	X	OOO	0 ~ 764	Input Relay
B	Y	OOO	0 ~ 764	Output Relay
B	M	DDDD	0 ~ 7999	Auxiliary Relay
B	T	DDD	0 ~ 511	Timer Relay (T)
B	C	DDD	0 ~ 255	Counter Relay (C)
B	SM	DDDD	8000 ~ 9999	Special Relay (M)
B	D_Bit	DDDDdd	0 ~ 799915	Data Register Bit (D)
B	S	DDDD	0 ~ 4095	State Relay (S)
W	TV	DDD	0 ~ 511	Timer Memory (T)
W	CV	DDD	0 ~ 199	Counter Memory (C)
W	D	DDDD	0 ~ 7999	Data Register (D)
DW	CV2	DDD	200 ~ 255	Counter Memory(D Word)
W	SD	DDDD	8000 ~ 9999	Special Data Register (D)
W	R	DDDDD	0 ~ 32767	Extended Register (R)
W	Z	D	0 ~ 7	Index register



Wiring Diagram:

The following represents the view of HMI & PLC.



eMT3000 series

COM1 RS485 4W 9P D-Sub Male			RS422 8P Mini-DIN Male
1 RX-			4 TX-
2 RX+			7 TX+
3 TX-			1 RX-
4 TX+			2 RX+
5 GND			3 GND
			

MT6000/8000 series except MT6050i/MT8050i

COM1 RS485 4W 9P D-Sub Male			RS422 8P Mini-DIN Male
1 RX-			4 TX-
2 RX+			7 TX+
3 TX-			1 RX-
4 TX+			2 RX+
5 GND			3 GND
			

MT6050i/MT8050i

COM1 RS485 4W 9P D-Sub Female			RS422 8P Mini-DIN Male
1 RX-			4 TX-
2 RX+			7 TX+
3 TX-			1 RX-
4 TX+			2 RX+
5 GND			3 GND
			

Driver Version:

Version	Date	Description
V1.71	Nov/15/2010	

Mitsubishi MELSEC-Q/L - ASCII Mode (Ethernet)

Supported Series: Mitsubishi Q series (Q03UDE, Q04UDEH, Q06UDEH, Q10UDEH, Q13UDEH, Q20UDEH, Q26UDEH), Mitsubishi L series(L02, L26-BT), MELSEC-Q/L protocol application to CPU of Ethernet interface or Ethernet module.

Website: <http://www.mitsubishi-automation.com>

HMI Setting:

Parameters	Recommended	Options	Notes
PLC type	Mitsubishi MELSEC-Q/L - ASCII Mode (Ethernet)		
PLC I/F	Ethernet		
Port no.	Set identically to the PLC setting		Advised to set port no. to 4999
Parameter 1	Networking no. (Set identically to PLC setting)	0~255	Q13UDEH has to be set to 0
PLC sta. no.	Set identically to the PLC setting	255	Q13UDEH has to be set to 255

PLC Setting:

MITSUBISHI Q/L series Ethernet module setting:

Note: If using QJ71E71 module, please refer to MITSUBISHI QJ71E71 connection guide.

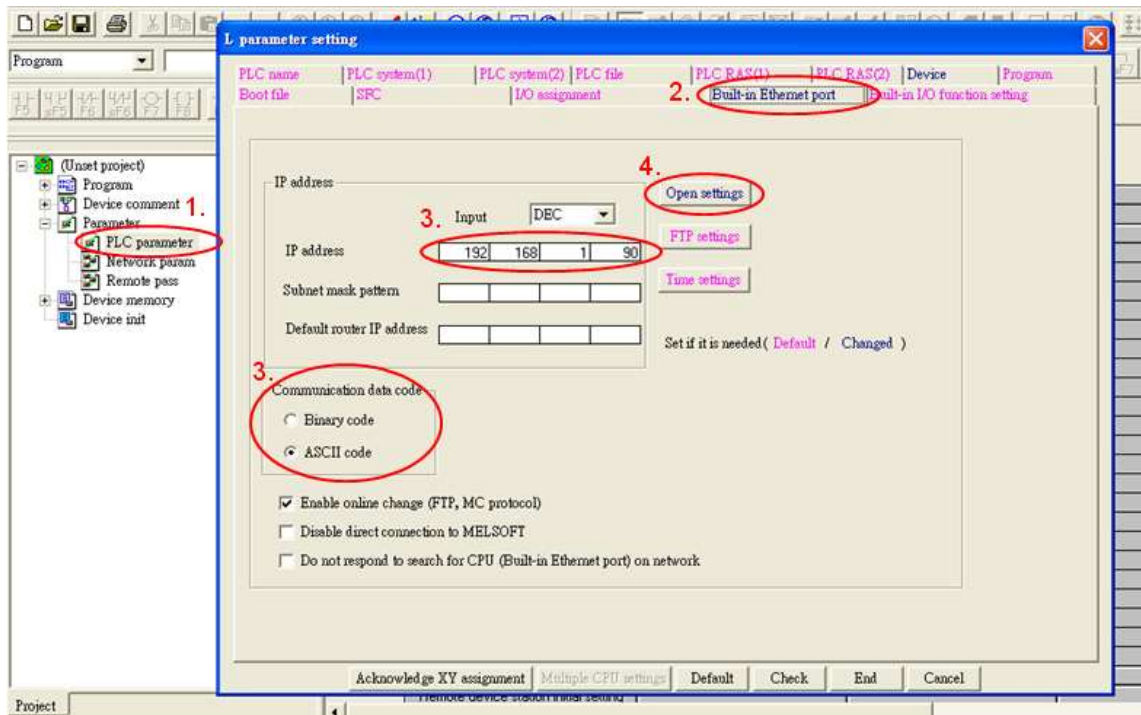

1. Click [PLC parameter].
2. [Built-in Ethernet port].
3. Click [Open settings] and then set the IP address and communication data code
4. Set the MC protocol-TCP Port No.1387 (Hex) and in EasyBuilder, TCP port is 4999 (Dec).

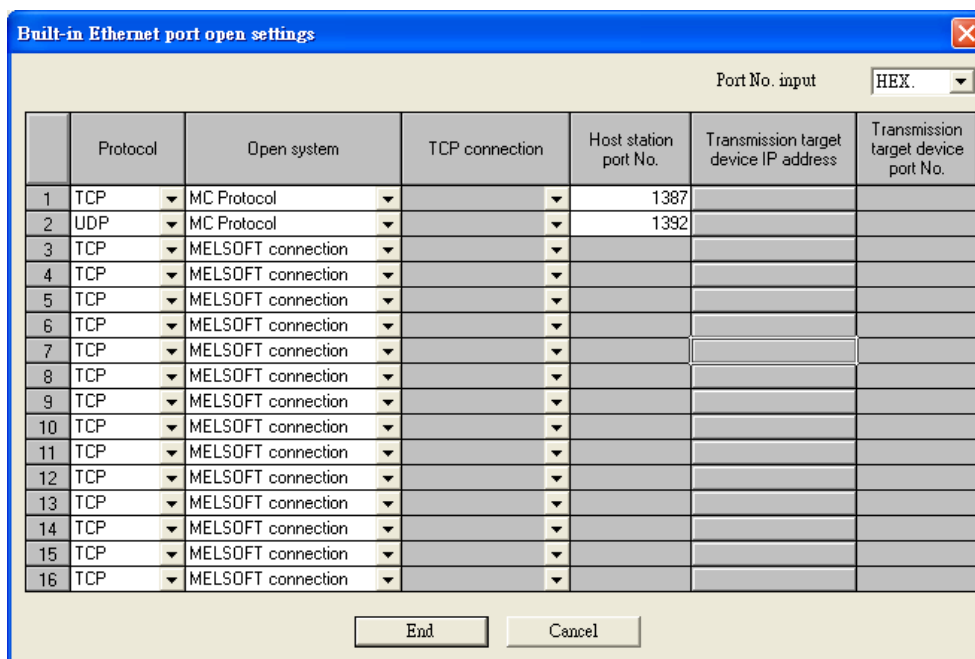

Note: In EasyBuilder, please fill in [Network No.] in Parameter 1 as PLC setting.
 For example below, the Network No. is 2.

Module 1	
Network type	Ethernet
Starting I/O No.	0000
Network No.	2
Total stations	
Group No.	1
Station No.	1
Mode	On line
	Operational settings
	Initial settings
	Open settings
	Router relay parameter
	Station No.<->IP information
	FTP Parameters
	E-mail settings

Set to 2 for Parameter 1 in EasyBuilder.

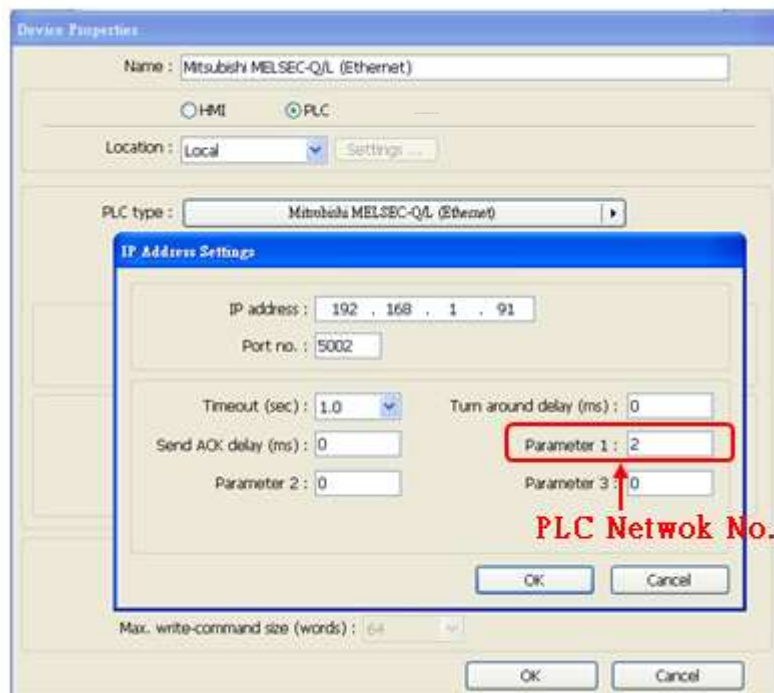

Device Address:

Bit/Word	Device type	Format	Range	Memo
B	SM	DDDD	0 ~ 2047	Special Relay
B	X	HHHH	0 ~ 1fff	Input Relay
B	Y	HHHH	0 ~ 1fff	Output Relay
B	M	DDDDD	0 ~ 61439	Internal Relay
B	L	DDDDD	0 ~ 32767	Latch Relay
B	F	DDDDD	0 ~ 32767	Annunciator
B	V	DDDDD	0 ~ 32767	Edge Relay
B	B	HHHH	0 ~ efff	Link Relay
B	TS	DDDDD	0 ~ 25471	Timer Contact
B	TC	DDDDD	0 ~ 25471	Timer Coil
B	SS	DDDDD	0 ~ 25471	Retentive Timer Contact
B	SC	DDDDD	0 ~ 25471	Retentive Timer Coil
B	CS	DDDDD	0 ~ 25471	Counter Contact
B	CC	DDDDD	0 ~ 25471	Counter Coil
B	SB	HHHH	0 ~ 7fff	Special Link Relay
B	S	DDDD	0 ~ 8191	Step relay
B	DX	HHHH	0 ~ 1fff	Direct Input
B	DY	HHHH	0 ~ 1fff	Direct Output
B	D_bit	DDDDDDh	0 ~ 999999f	Data Register bit
B	SD_bit	DDDDh	0 ~ 2047f	Special register Bit
B	ZR_bit	DDDDDDh	0 ~ 999999f	File Register Bit
B	R_bit	DDDDh	0 ~ 32767f	File Register Bit
B	SW_bit	HHHh	0 ~ 7fff	Special Link Register Bit
B	W_bit	HHHHHHh	0 ~ 3fd7fff	Link Register Bit
W	SD	DDDD	0 ~ 2047	Special register
W	D	DDDDDD	0 ~ 999999	Data Register
W	W	HHHHHH	0 ~ 3fd7ff	Link Register
W	TN	DDDDD	0 ~ 25471	Timer Current value
W	SN	DDDDD	0 ~ 25471	Retentive Timer Current value
W	CN	DDDDD	0 ~ 25471	Counter Current value
W	SW	HHH	0 ~ 7ff	Special Link Register
W	Z	DD	0 ~ 20	Index Register
W	R	DDDDD	0 ~ 32767	File Register
W	ZR	DDDDDD	0 ~ 999999	File Register

Note: Each model of CPU is different, it is recommended to refer to MITSUBISHI MELSEC-Q Manual Device List.

Wiring Diagram:

Direct connect (crossover cable):

HMI RJ45 Male	Wire Color	Wire Color	PLC RJ45 Male
1 TX+	White/Orange	White/Green	3 RX+
2 TX-	Orange	Green	6 RX-
3 RX+	White/Green	White/Orange	1 TX+
4 BD4+	Blue	Blue	4 BD4+
5 BD4-	White/Blue	White/Blue	5 BD4-
6 RX-	Green	Orange	2 TX-
7 BD3+	White/Brown	White/Brown	7 BD3+
8 BD3-	Brown	Brown	8 BD3-



Through a hub:

HMI RJ45 Male	Wire Color	Wire Color	PLC RJ45 Male
1 TX+	White/Orange	White/Orange	1 TX+
2 TX-	Orange	Orange	2 TX-
3 RX+	White/Green	White/Green	3 RX+
4 BD4+	Blue	Blue	4 BD4+
5 BD4-	White/Blue	White/Blue	5 BD4-
6 RX-	Green	Green	6 RX-
7 BD3+	White/Brown	White/Brown	7 BD3+
8 BD3-	Brown	Brown	8 BD3-



Driver Version:

Version	Date	Description
V1.00	Jul/10/2012	Driver released.

Mitsubishi MELSEC-Q/L - Binary Mode (Ethernet)

Supported Series: Mitsubishi Q series (Q03UDE, Q04UDEH, Q06UDEH, Q10UDEH, Q13UDEH, Q20UDEH, Q26UDEH), Mitsubishi L series(L02, L26-BT), MELSEC-Q/L protocol application to CPU of Ethernet interface or Ethernet module.

Website: <http://www.mitsubishi-automation.com>

HMI Setting:

Parameters	Recommended	Options	Notes
PLC type	Mitsubishi MELSEC-Q/L - Binary Mode (Ethernet)		
PLC I/F	Ethernet		
Port no.	Set identically to the PLC setting		Advised to set port no. to 4999
Parameter 1	Networking no. (Set identically to PLC setting)	0~255	Q13UDEH has to be set to 0
PLC sta. no.	Set identically to the PLC setting	255	Q13UDEH has to be set to 255

PLC Setting:

MITSUBISHI Q/L series Ethernet module setting:

Note: If using QJ71E71 module, please refer to MITSUBISHI QJ71E71 connection guide.

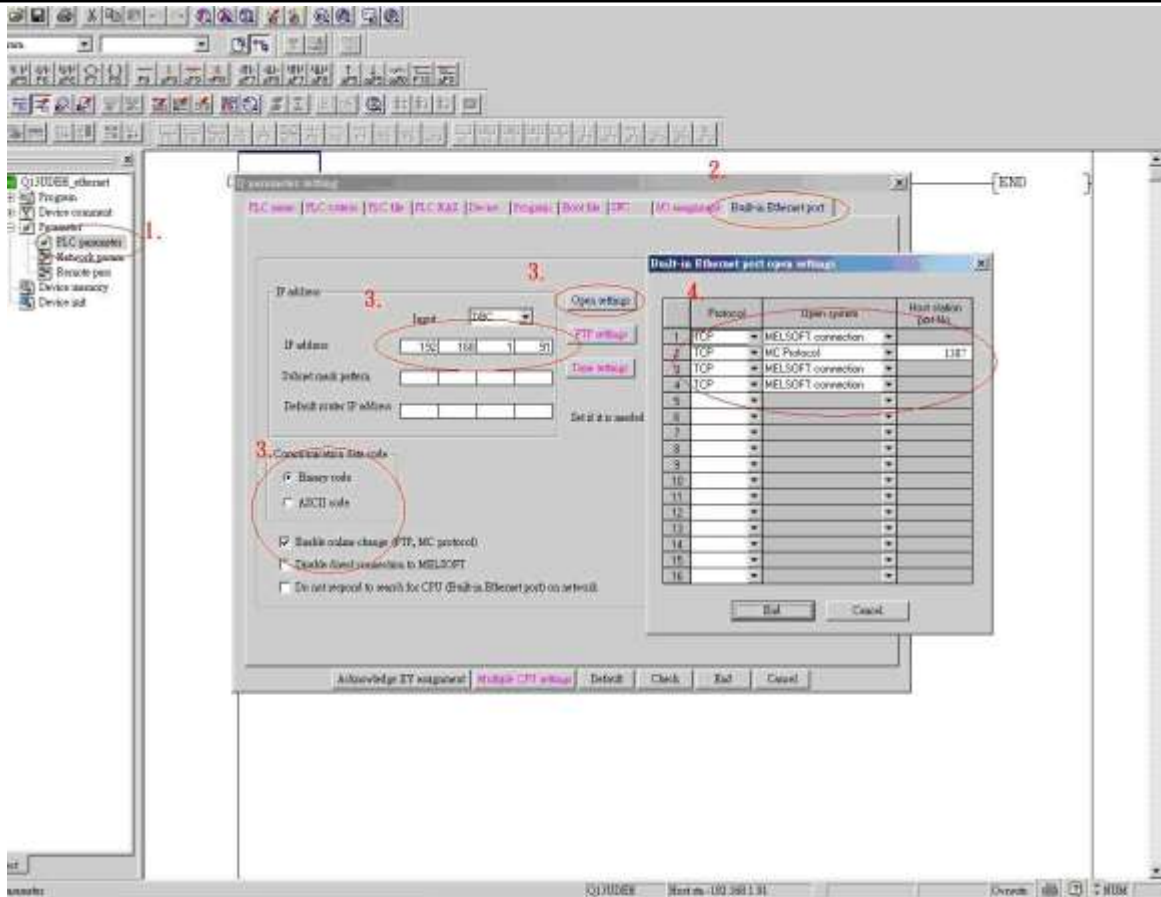

1. Click [PLC parameter].
2. [Built-in Ethernet port].
3. Click [Open settings] and then set the IP address and communication data code
4. Set the MC protocol-TCP Port No.1387 (Hex) and in EasyBuilder, TCP port is 4999 (Dec).

Note: In EasyBuilder, please fill in [Network No.] in Parameter 1 as PLC setting. For example below, the Network No. is 2.

	Module 1
Network type	Ethernet
Starting I/O No.	0000
Network No.	2
Total stations	
Group No.	1
Station No.	1
Mode	On line
	Operational settings
	Initial settings
	Open settings
	Router relay parameter
	Station No.<>IP information
	FTP Parameters
	E-mail settings

Set to 2 for Parameter 1 in EasyBuilder.

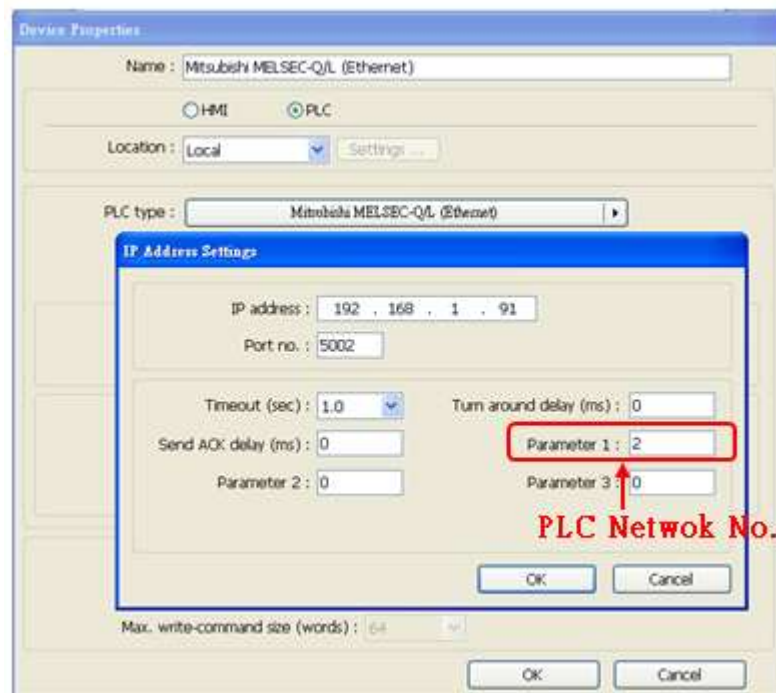

Device Address:

Bit/Word	Device type	Format	Range	Memo
B	SM	DDDD	0 ~ 2047	Special Relay
B	X	HHHH	0 ~ 1fff	Input Relay
B	Y	HHHH	0 ~ 1fff	Output Relay
B	M	DDDDD	0 ~ 61439	Internal Relay
B	L	DDDDD	0 ~ 32767	Latch Relay
B	F	DDDDD	0 ~ 32767	Annunciator
B	V	DDDDD	0 ~ 32767	Edge Relay
B	B	HHHH	0 ~ efff	Link Relay
B	TS	DDDDD	0 ~ 25471	Timer Contact
B	TC	DDDDD	0 ~ 25471	Timer Coil
B	SS	DDDDD	0 ~ 25471	Retentive Timer Contact
B	SC	DDDDD	0 ~ 25471	Retentive Timer Coil
B	CS	DDDDD	0 ~ 25471	Counter Contact
B	CC	DDDDD	0 ~ 25471	Counter Coil
B	SB	HHHH	0 ~ 7fff	Special Link Relay
B	S	DDDD	0 ~ 8191	Step relay
B	DX	HHHH	0 ~ 1fff	Direct Input
B	DY	HHHH	0 ~ 1fff	Direct Output
B	D_Bit	DDDDDDh	0 ~ 4184063f	Data Register bit

Bit/Word	Device type	Format	Range	Memo
B	SD_bit	DDDDh	0 ~ 2047f	Special register Bit
B	ZR_bit	HHHHHHh	0 ~ 3fd7fff	File Register Bit
B	R_bit	DDDDDh	0 ~ 32767f	File Register Bit
B	SW_bit	HHHh	0 ~ 7ff	Special Link Register Bit
B	W_bit	HHHHHHh	0 ~ 3fd7fff	Link Register Bit
W	SD	DDDD	0 ~ 2047	Special register
W	D	DDDDDDD	0 ~ 4184063	Data Register
W	W	HHHHHH	0 ~ 3fd7ff	Link Register
W	TN	DDDDD	0 ~ 25471	Timer Current value
W	SN	DDDDD	0 ~ 25471	Retentive Timer Current value
W	CN	DDDDD	0 ~ 25471	Counter Current value
W	SW	HHH	0 ~ 7ff	Special Link Register
W	Z	DD	0 ~ 20	Index Register
W	R	DDDDD	0 ~ 32767	File Register
W	ZR	HHHHHH	0 ~ 3fd7ff	File Register

Note: Each model of CPU is different, it is recommended to refer to MITSUBISHI MELSEC-Q Manual Device List.

Wiring Diagram:

Direct connect (crossover cable):

HMI RJ45 Male	Wire Color	Wire Color	PLC RJ45 Male
1 TX+	White/Orange	White/Green	3 RX+
2 TX-	Orange	Green	6 RX-
3 RX+	White/Green	White/Orange	1 TX+
4 BD4+	Blue	Blue	4 BD4+
5 BD4-	White/Blue	White/Blue	5 BD4-
6 RX-	Green	Orange	2 TX-
7 BD3+	White/Brown	White/Brown	7 BD3+
8 BD3-	Brown	Brown	8 BD3-



Through a hub:

HMI RJ45 Male	Wire Color	Wire Color	PLC RJ45 Male
1 TX+	White/Orange	White/Orange	1 TX+
2 TX-	Orange	Orange	2 TX-
3 RX+	White/Green	White/Green	3 RX+
4 BD4+	Blue	Blue	4 BD4+
5 BD4-	White/Blue	White/Blue	5 BD4-
6 RX-	Green	Green	6 RX-
7 BD3+	White/Brown	White/Brown	7 BD3+
8 BD3-	Brown	Brown	8 BD3-



Driver Version:

Version	Date	Description
V1.30	Jan/14/2011	

Mitsubishi MR J3 A

Website: <http://www.mitsubishi-automation.com>

HMI Setting:

Parameters	Recommended	Options	Notes
PLC type	Mitsubishi MR J3 A		
PLC I/F	RS485 4W	RS232/RS485	
Baud rate	9600	9600~115200	
Parity	Even		
Data bits	8		
Stop bits	1		
PLC sta. no.	0	0~31	

Device Address:

Bit/Word	Device type	Format	Range	Memo
B	EIP	DD	0 ~ 31	External input pin status read**
B	EOP	DD	0 ~ 31	External output pin status read**
W	PA	DD	1 ~ 19	Basic Setting
W	PB	DD	1 ~ 45	Gain / Filter Setting
W	PC	DD	1 ~ 50	Extension Setting
W	PD	DD	1 ~ 30	Input / Output Setting
W	Status	DD	0 ~ 17	Amplifier Status
W	Alarm	D	0 ~ 6	Alarm
W	Alarm_T	D	0 ~ 6	Alarm Time (Hour)
W	Mode	D	1 ~ 4	Write Only, Mode Setting*
W	Speed	D	0 ~ 1	Write Only, Set Current Speed *
W	Acc	D	0 ~ 1	Write Only, Set Acceleration*
W	Rotation	D	0 ~ 1	Write Only, Rotation Direction*
W	End	D	0 ~ 1	Write Only, End*
W	M_dist	D	0 ~ 1	Write Only, Moving Distance*
W	Rot_P	D	0 ~ 1	Write Only, Rotation Position*
W	P_start	D	0 ~ 1	Write Only, Start Positioning*

Note: 1.* represents the write-only registers. The usage of this kind of registers is to run Jog Mode and Positioning Mode.

2.** represents the read-only registers.

EIP:

The ON/OFF statuses of the input pins are sent back.



Command of each bit is transmitted to the master station as hexadecimal data.

bit	CN1 connector pin
0	43
1	44
2	42
3	15
4	19
5	41
6	16
7	17

bit	CN1 connector pin
8	18
9	45
10	
11	
12	
13	
14	
15	

bit	CN1 connector pin
16	
17	
18	
19	
20	
21	
22	
23	

bit	CN1 connector pin
24	
25	
26	
27	
28	
29	
30	
31	

EOP:

The slave station sends back the ON/OFF statuses of the output pins.

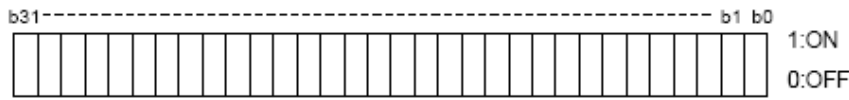

Command of each bit is transmitted to the master station as hexadecimal data.

bit	CN1 connector pin
0	49
1	24
2	23
3	25
4	22
5	48
6	33
7	

bit	CN1 connector pin
8	
9	
10	
11	
12	
13	
14	
15	

bit	CN1 connector pin
16	
17	
18	
19	
20	
21	
22	
23	

bit	CN1 connector pin
24	
25	
26	
27	
28	
29	
30	
31	

How to use EasyBuilder8000/Easy BuilderPro to run Jog and Positioning Mode

*Jog Mode

To run Jog Mode, please follow the steps listed sequentially:

- (1) Set Jog Mode
- (2) Set rotation speed
- (3) Set acceleration
- (4) Set forward / reverse rotation direction
- (5) End

The following shows how to run the steps above using Macro in EasyBuilder8000/Easy BuilderPro.



On the editing window of EasyBuilder8000/Easy BuilderPro, the write address of "speed" is set to Local HMI LW0 (the address can be user-defined), and set "Acc" (Acceleration) to LW1.

To run Jog Mode, the communication with the device must be continuous which only allows an interval less than 0.5 seconds, otherwise the motor will be locked. Therefore, in this example, only one register PA_1 is set to read device value.

Macro Demonstration:

a. Start Macro

```
macro_command main()
```

```
short speed
```

```
short acc
```

```
short mode
```

```
mode = 1 // This represents Jog Mode.
```

```
SetData(mode, "MITSUBISHI MR J3 A", Mode, 1, 1) // Set driver mode to Jog.
```

```
GetData(speed, "Local HMI", LW, 0, 1) // Save LW0 value to speed.
```

```
SetData(speed, "MITSUBISHI MR J3 A", Speed, 0, 1) // Set motor operating speed.
```

```

GetData(acc, "Local HMI", LW, 1, 1) //
SetData(acc, "MITSUBISHI MR J3 A", Acc, 0, 1) // Set motor acceleration.
    
```

short motion

```

motion = 0x0801 // Special code, see Note 1.
    
```

```

SetData(motion, "MITSUBISHI MR J3 A", Rotation, 0, 1) // Rotate.
    
```

```

end macro_command
    
```

Note 1. Original Factory Manual:

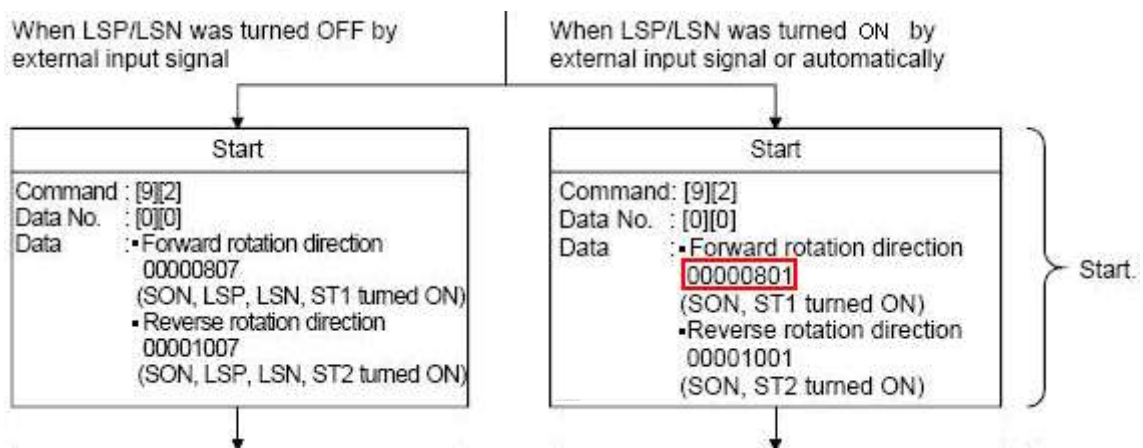

b. End Macro

```

macro_command main()
    
```

short stop

```

stop = 1 // See Note 2.
    
```

```

SetData(stop, "MITSUBISHI MR J3 A", End, 1, 1)
    
```

```

end macro_command
    
```

Note 2. Original Factory Manual:

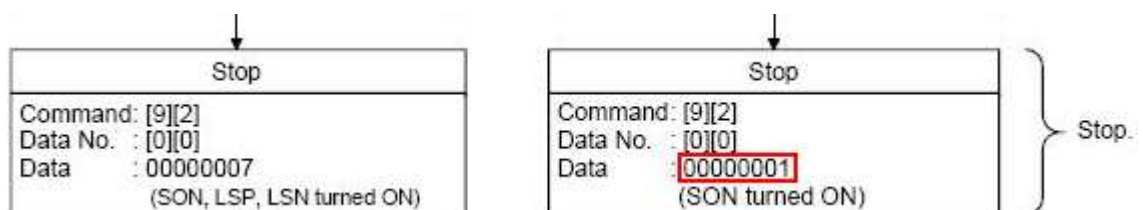

*Positioning Mode

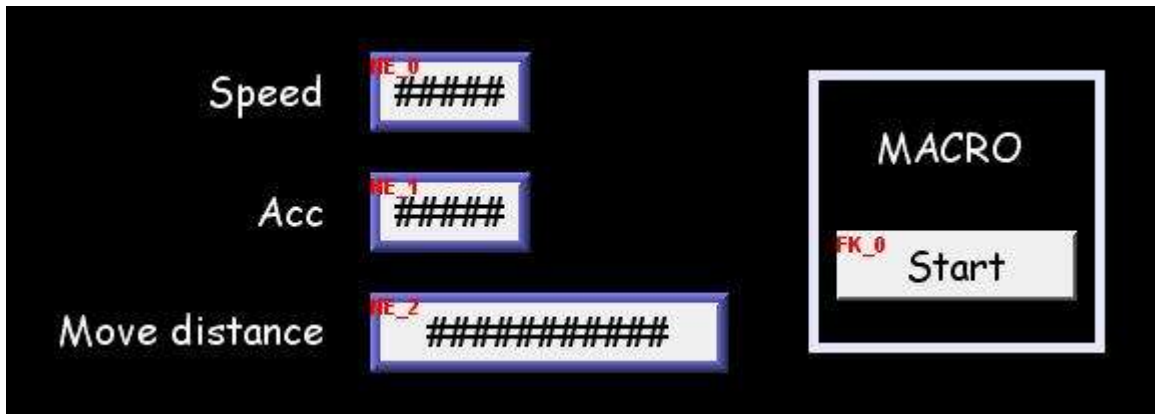

On the editing window of EasyBuilder8000/Easy BuilderPro, the write address of “Speed” is set to Local HMI LW2 (the address can be user-defined), and set “Acc” (Acceleration) to LW3, “Move distance” to LW4 (DW format).

Macro Demonstration:

```
macro_command main()
```

```
short mode
```

```
mode = 0x2 // Positioning Mode
```

```
SetData(mode, "MITSUBISHI MR J3 A", Mode, 1, 1)
```

```
short speed
```

```
GetData(speed, "Local HMI", LW, 2, 1)
```

```
SetData(speed, "MITSUBISHI MR J3 A", Speed, 0, 1)
```

```
short acc
```

```
GetData(acc, "Local HMI", LW, 3, 1)
```

```
SetData(acc, "MITSUBISHI MR J3 A", Acc, 0, 1)
```

```
short dist
```

```
GetData(dist, "Local HMI", LW, 4, 1)
```

```
SetData(dist, "MITSUBISHI MR J3 A", M_dist, 0, 1)
```

```
short rot_P
```

```
rot_P = 1 // Set to 0: Forward Rotation 1: Reverse Rotation
```

```
SetData(rot_P, "MITSUBISHI MR J3 A", Rot_P, 0, 1)
```

```
short rotat
```

```
rotat = 1 // See Note 3.
```

```
SetData(rotat, "MITSUBISHI MR J3 A", Rotation, 0, 1)
```

```
SetData(rot_P, "MITSUBISHI MR J3 A", P_start, 0, 1) // Start Positioning.
```

```
end macro_command
```

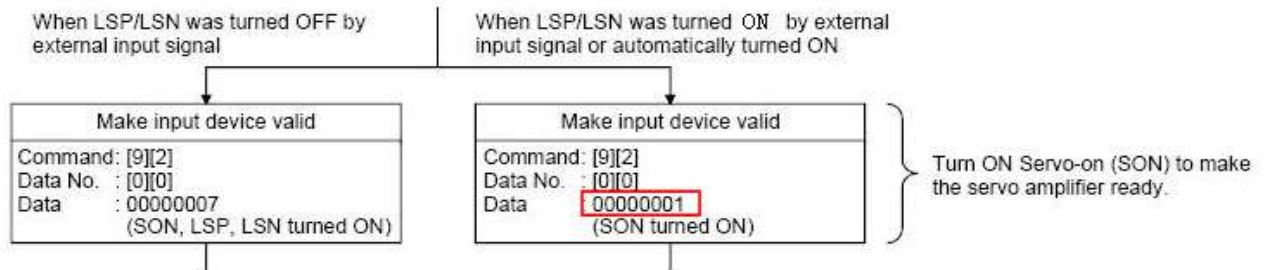

Note 3. Original Factory Manual





Wiring Diagram:

The following represents the view of HMI & PLC.



eMT3000 series

COM1 RS485 4W 9P D-Sub Male			CN3 RS485 4W RJ45 Male
1 RX-		—	4 TX-
2 RX+			5 TX+
3 TX-			6 RX-
4 TX+			3 RX+
5 GND			7 GND
			

MT6000/8000 series except MT6050i/MT8050i

COM1 RS485 4W 9P D-Sub Male			CN3 RS485 4W RJ45 Male
1 RX-			4 TX-
2 RX+			5 TX+
3 TX-			6 RX-
4 TX+			3 RX+
5 GND			7 GND
			

MT6050i/MT8050i

COM1 RS485 4W 9P D-Sub Female			CN3 RS485 4W RJ45 Male
1 RX-			4 TX-
2 RX+			5 TX+
3 TX-			6 RX-
4 TX+			3 RX+
5 GND			7 GND
			

Driver Version:

Version	Date	Description
V1.00	Sep/01/2011	Driver released.
V1.10	Jan/13/2012	Added register: EIP and EOP.

Mitsubishi MR-MQ100 (Ethernet)

Supported Series: Mitsubishi MR-MQ100-Ethernet

Website: <http://www.mitsubishi-automation.com>

HMI Setting:

Parameters	Recommended	Options	Notes
PLC type	Mitsubishi MR-MQ100 (Ethernet)		
PLC I/F	Ethernet		
Port no.	Set identically to the PLC setting		Advised to set port no. to 4999
Parameter1	1		Network No.
PLC sta. no.	255		

PLC Setting:

The screenshot shows the MELSOFT Series MT Developer2 software interface. The Project tree on the left shows the 'Basic Setting' folder selected. The 'Basic Setting' dialog box is open, with the 'Built-in Ethernet Port Setting' tab selected. The 'Open Setting' button is highlighted. The 'Built-in Ethernet Port Open Setting' dialog box is also open, showing a table of port settings.

	Protocol	Open System	Host Station Port No.
1	UDP	MELSOFT Connection	
2	TCP	MC Protocol	1387
3	TCP	MC Protocol	2000
4	TCP	MC Protocol	3000
5	TCP	MELSOFT Connection	
6	TCP	MELSOFT Connection	
7	TCP	MELSOFT Connection	
8	TCP	MELSOFT Connection	
9	TCP	MELSOFT Connection	
10	TCP	MELSOFT Connection	
11	TCP	MELSOFT Connection	
12	TCP	MELSOFT Connection	
13	TCP	MELSOFT Connection	
14	TCP	MELSOFT Connection	
15	TCP	MELSOFT Connection	
16	TCP	MELSOFT Connection	

Host station port No.: Please input in HEX.

1. Click [Basic Setting].
2. [Built-in Ethernet Port Setting].
3. Click [Open Setting] and then set the IP address and communication data code.
4. Set the MC Protocol-TCP Port No. (Hex)

Device Address:

Bit/Word	Device type	Format	Range	Memo
B	SM	DDDD	0 ~ 2255	Special Relay
B	X	HHHH	0 ~ 1fff	Input
B	Y	HHHH	0 ~ 1fff	Output
B	M	DDDDD	0 ~ 61439	Internal Relay
B	F	DDDDD	0 ~ 32767	Annunciator
B	B	HHHH	0 ~ efff	Link Relay
B	D_Bit	DDDDDDh	0 ~ 4184063f	
W	SD	DDDD	0 ~ 2255	Special Register
W	D	DDDDDD	0 ~ 4184063	Data Register
W	W	HHHHH	0 ~ 3fd7ff	Link Register
W	#	DDDDD	0 ~ 12287	Motion Register

Note: ddd: Decimal, hhh: Hexadecimal, ooo: Octal.

Wiring Diagram:

Direct connect (crossover cable):

HMI RJ45 Male	Wire Color	Wire Color	PLC RJ45 Male
1 TX+	White/Orange	White/Green	3 RX+
2 TX-	Orange	Green	6 RX-
3 RX+	White/Green	White/Orange	1 TX+
4 BD4+	Blue	Blue	4 BD4+
5 BD4-	White/Blue	White/Blue	5 BD4-
6 RX-	Green	Orange	2 TX-
7 BD3+	White/Brown	White/Brown	7 BD3+
8 BD3-	Brown	Brown	8 BD3-



Through a hub:

HMI RJ45 Male	Wire Color	Wire Color	PLC RJ45 Male
1 TX+	White/Orange	White/Orange	1 TX+
2 TX-	Orange	Orange	2 TX-
3 RX+	White/Green	White/Green	3 RX+
4 BD4+	Blue	Blue	4 BD4+
5 BD4-	White/Blue	White/Blue	5 BD4-
6 RX-	Green	Green	6 RX-
7 BD3+	White/Brown	White/Brown	7 BD3+
8 BD3-	Brown	Brown	8 BD3-



Driver Version:

Version	Date	Description
V1.10	Jun/08/2011	Added register: D_Bit

Mitsubishi Q00/Q00UJ/Q01/QJ71

Supported Series: Mitsubishi Q series PLC with QJ71C24 communication module, Q00, Q00J, Q00UJ, Q01, Q02H, Q06H, Q12H, Q25H, Q12PH, Q25PH CPU port.

Website: <http://www.mitsubishi-automation.com>

HMI Setting:

Parameters	Recommended	Options	Notes
PLC type	Mitsubishi Q00/Q00UJ/Q01/QJ71		
PLC I/F	RS232	RS485 4W, RS232	
Baud rate	9600	9600~115200	
Data bits	8		
Parity	Odd		
Stop bits	1		
PLC sta. no.	0		

Online simulator	Yes	Extend address mode	NO
------------------	-----	---------------------	----

PLC Setting:

Q00, Q01 CPU port setting:

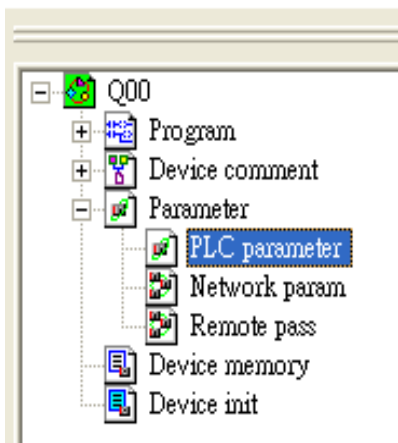

1. In GX Developer "PLC data list" click [PLC parameter].
2. In "PLC parameter" go to [Serial] page.
3. Select [Use serial communication].
4. Set [Transmission speed] to 9600~115200.
5. Select [Sum check].
6. Set [Transmission wait time] to 10ms.
7. Permit [RUN write setting].
8. Click [End] to close the dialog.
9. Write the PLC Parameter to PLC.
10. Reset PLC, the parameter will be activated.

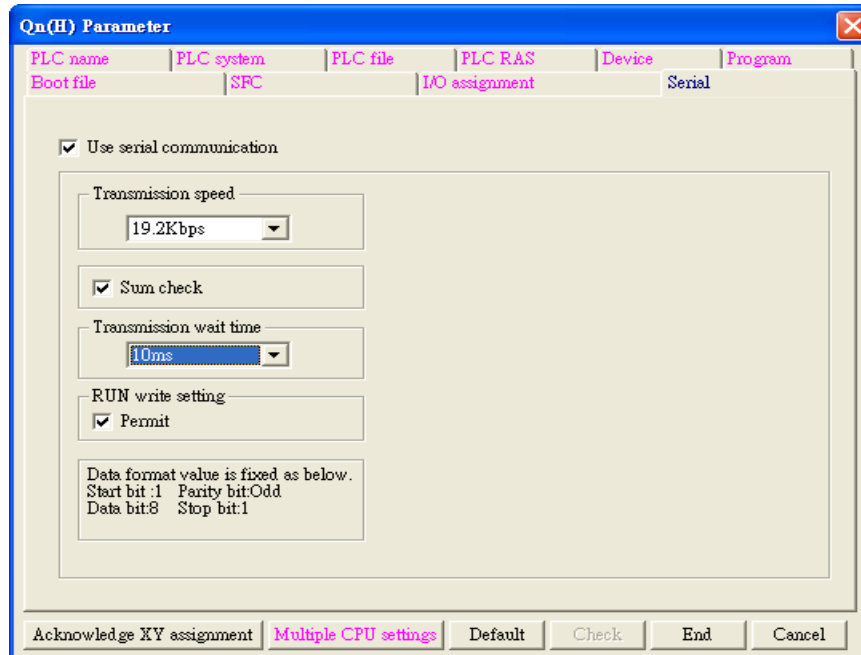

QJ71 setting:

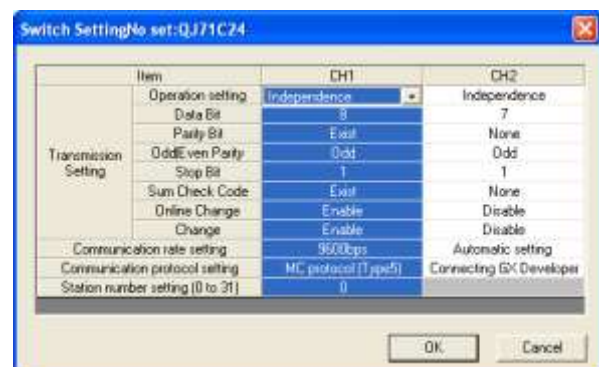
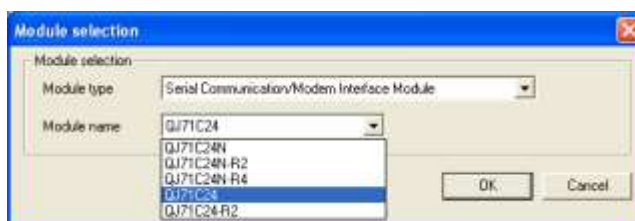
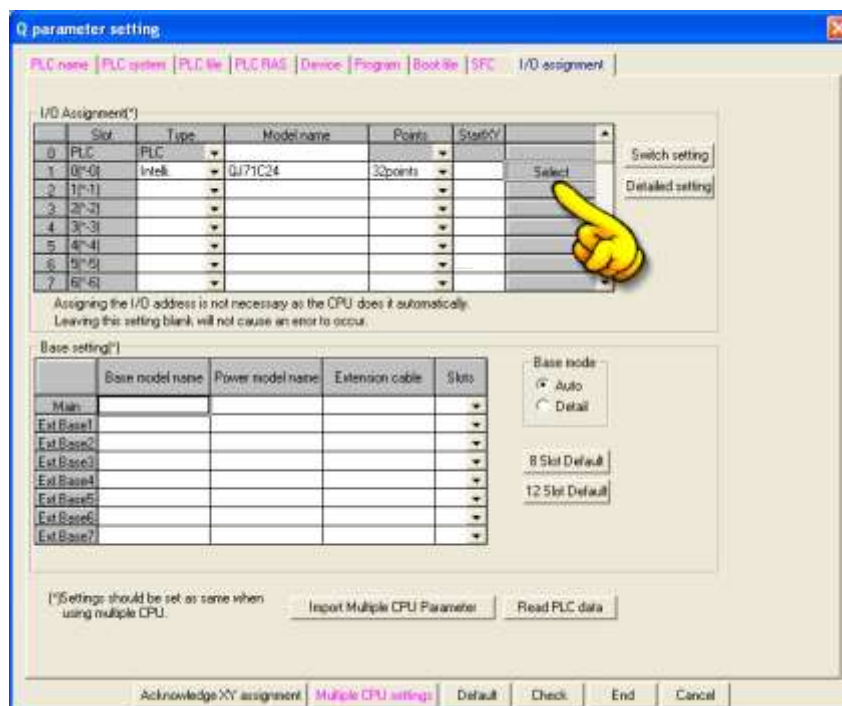

Device Address:



Bit/Word	Device type	Format	Range	Memo
B	X	HHHH	0 ~ 1fff	Input Relay
B	Y	HHHH	0 ~ 1fff	Output Relay
B	M	DDDD	0 ~ 8191	Internal Relay
B	L	DDDD	0 ~ 8191	Latch Relay
B	F	DDDD	0 ~ 2047	Annunciator
B	V	DDDD	0 ~ 2047	Edge Relay
B	B	HHHH	0 ~ 1fff	Link Relay
B	TC	DDDD	0 ~ 2047	Timer Coil
B	SS	DDDD	0 ~ 2047	Retentive Timer Contact
B	SC	DDDD	0 ~ 2047	Retentive Timer Coil
B	CS	DDDD	0 ~ 1023	Counter Contact
B	CC	DDDD	0 ~ 1023	Counter Coil
B	SB	HHH	0 ~ 7ff	Special Link Relay
B	S	DDDD	0 ~ 8191	Step Relay
B	DX	HHHH	0 ~ 1fff	Direct Input
B	DY	HHHH	0 ~ 1fff	Direct Output
B	TS	DDDD	0 ~ 2047	Timer Contact
B	SM	DDDD	0 ~ 2047	
B	D_Bit	DDDDh	0 ~ 12287f	
W	W	HHHH	0 ~ 2fff	Link Register
W	TN	DDDD	0 ~ 2047	Timer Current Value
W	SN	DDDD	0 ~ 2047	Retentive Timer Current Value
W	CN	DDDD	0 ~ 1023	Counter Current Value
W	R	DDDDD	0 ~ 32767	File Register
W	SW	HHH	0 ~ 7ff	Special Link Register
W	Z	DD	0 ~ 15	Index Register
W	ZR	HHHH	0 ~ ffff	File Register
W	D	DDDDD	0 ~ 12287	Data Register
W	SD	DDDD	0 ~ 2047	

Wiring Diagram:



The following represents the view of HMI & PLC.

QJ71C24 CH.2 RS422 Terminal



eMT3000 series

COM1 RS485 4W 9P D-Sub Male			QJ71C24 CH.2 RS422 Terminal
1 RX-			SDB
2 RX+			SDA
3 TX-			RDB
4 TX+			RDA
5 GND			GND
			

MT6000/8000 series except MT6050i/MT8050i

COM1 RS485 4W 9P D-Sub Male			QJ71C24 CH.2 RS422 Terminal
1 RX-			SDB
2 RX+		—	SDA
3 TX-			RDB
4 TX+			RDA
5 GND			GND
			



MT6050i/MT8050i

COM1 RS485 4W 9P D-Sub Female			QJ71C24 CH.2 RS422 Terminal
1 RX-			SDB
2 RX+			SDA
3 TX-			RDB
4 TX+			RDA
5 GND			GND
			





The following represents the view of HMI & PLC.

QJ71C24 CH.2 RS232



eMT3000 series

COM1 RS232 9P D-Sub Female	COM3 RS232 9P D-Sub Female		QJ71C24 CH.1 RS232 9P D-Sub Male
2 RX	8 RX		3 TXD
3 TX	7 TX	—	2 RXD
5 GND	5 GND		5 GND
			1 DCD
			4 DTR
			6 DSR
			7 RTS
			8 CTS
			circuit
			circuit
			

MT6000/8000 series except MT6050i/MT8050i

COM1 RS232 9P D-Sub Female	COM2 RS232 9P D-Sub Female	COM3 RS232 9P D-Sub Male	QJ71C24 CH.1 RS232 9P D-Sub Male	
2 RX	6 RX	8 RX	3 TXD	
3 TX	4 TX	7 TX	2 RXD	
5 GND	5 GND	5 GND	5 GND	
			1 DCD	circuit
			4 DTR	
			6 DSR	
			7 RTS	circuit
			8 CTS	
				



MT6050i/MT8050i

COM1 RS232 9P D-Sub Female			QJ71C24 CH.1 RS232 9P D-Sub Male	
9 RX			3 TXD	
6 TX			2 RXD	
5 GND			5 GND	
			1 DCD	circuit
			4 DTR	
			6 DSR	
			7 RTS	circuit
			8 CTS	
				





The following represents the view of HMI & PLC.

9P D-Sub to 6P Mini-DIN: Q00, Q01 CPU port RS232



eMT3000 series

COM1 RS232 9P D-Sub Female	COM3 RS232 9P D-Sub Female		RS232 6P Mini-DIN Male
2 RX	8 RX		3 TXD
3 TX	7 TX		4 RXD
5 GND	5 GND		5 GND
			

MT6000/8000 series except MT6050i/MT8050i

COM1 RS232 9P D-Sub Female	COM2 RS232 9P D-Sub Female	COM3 RS232 9P D-Sub Male	RS232 6P Mini-DIN Male
2 RX	6 RX	8 RX	3 TXD
3 TX	4 TX	7 TX	4 RXD
5 GND	5 GND	5 GND	5 GND
			



MT6050i/MT8050i

COM1 RS232 9P D-Sub Female			RS232 6P Mini-DIN Male
9 RX			3 TXD
6 TX			4 RXD
5 GND			5 GND
			



The following represents the view of HMI & PLC.

9P D-Sub to 6P Mini-DIN: Q00UJ CPU port RS232

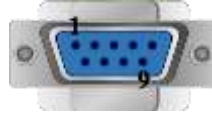

eMT3000 series

COM1 RS232 9P D-Sub Female	COM3 RS232 9P D-Sub Female		RS232 6P Mini-DIN Male
2 RX	8 RX		3 TXD
3 TX	7 TX		4 RXD
5 GND	5 GND		5 GND
			1 RTS
			6 CTS
			circuit
			

MT6000/8000 series except MT6050i/MT8050i

COM1 RS232 9P D-Sub Female	COM2 RS232 9P D-Sub Female	COM3 RS232 9P D-Sub Male	RS232 6P Mini-DIN Male
2 RX	6 RX	8 RX	3 TXD
3 TX	4 TX	7 TX	4 RXD
5 GND	5 GND	5 GND	5 GND
			1 RTS
			6 CTS
			circuit
			

MT6050i/MT8050i

COM1 RS232 9P D-Sub Female			RS232 6P Mini-DIN Male
9 RX			3 TXD
6 TX			4 RXD
5 GND			5 GND
			1 RTS
			6 CTS
			circuit
			

Driver Version:

Version	Date	Description
V1.80	Jun/08/2011	Added register: D_Bit
V1.90	Sep/23/2011	Fixed bit communication incorrect.

Mitsubishi Q00J

Supported Series: Mitsubishi Q00J CPU

HMI Setting:

Parameters	Recommended	Options	Notes
PLC type	Mitsubishi Q00J		
PLC I/F	RS232		CPU port
Baud rate	115200	9600,19200,38400, 57600,115200	
Data bits	8		
Parity	Odd		
Stop bits	1		
PLC sta. no.			

Online simulator	NO	Extend address mode	NO
------------------	----	---------------------	----

Device Address:



Bit/Word	Device type	Format	Range	Memo
B	SM	DDDD	0 ~ 1023	
B	X	HHH	0 ~ 7ff	
B	Y	HHH	0 ~ 7ff	
B	M	DDDD	0 ~ 8191	
B	L	DDDD	0 ~ 2047	
B	F	DDDD	0 ~ 1023	
B	V	DDDD	0 ~ 1023	
B	B	HHH	0 ~ 7ff	
B	SB	HHH	0 ~ 3ff	
B	D_Bit	DDDDh	0 ~ 11135f	
W	SD	DDDD	0 ~ 1023	
W	D	DDDDD	0 ~ 11135	
W	W	HHH	0 ~ 7ff	
W	SW	HHH	0 ~ 3ff	
W	Z	D	0 ~ 9	
W	C	DDD	0 ~ 511	
W	T	DDD	0 ~ 511	

Wiring Diagram:





The following represents the view of HMI & PLC.

9P D-Sub to 6P Mini-DIN: Q00 CPU port RS232



eMT3000 series

COM1 RS232 9P D-Sub Female	COM3 RS232 9P D-Sub Female		RS232 6P Mini-DIN Male
2 RX	8 RX		3 TXD
3 TX	7 TX		4 RXD
5 GND	5 GND		5 GND
			

MT6000/8000 series except MT6050i/MT8050i

COM1 RS232 9P D-Sub Female	COM2 RS232 9P D-Sub Female	COM3 RS232 9P D-Sub Male	RS232 6P Mini-DIN Male
2 RX	6 RX	8 RX	3 TXD
3 TX	4 TX	7 TX	4 RXD
5 GND	5 GND	5 GND	5 GND
			

MT6050i/MT8050i

COM1 RS232 9P D-Sub Female			RS232 6P Mini-DIN Male
9 RX			3 TXD
6 TX			4 RXD
5 GND			5 GND
			

MT8-Mitsubishi-Q-3M cable can connect MT8000 with Mitsubishi Q series directly.

Driver Version:

Version	Date	Description
V1.20	Jun/08/2011	Added register D_bit

Mitsubishi Q00U/Q01U/Q02U/QnUD/QnUDH

Supported Series: Mitsubishi Q00U, Q01U, Q02U, Q03UD, Q04UDH, Q06UDH, Q10UDH, Q13UDH, Q20UDH, Q26UDH, Q00UJ CPU.

HMI Setting:

Parameters	Recommended	Options	Notes
PLC type	Mitsubishi Q00U/Q01U/Q02U/QnUD/QnUDH		
PLC I/F	RS232	RS485 4W, RS232	CPU port direct connect
Baud rate	115200	115200 only	9600,19200,38400,57600,115200 For Q00UJ, only 9600 is available
Data bits	8		
Parity	Odd		
Stop bits	1		
PLC sta. no.	No		

Online simulator	NO	Extend address mode	NO
------------------	----	---------------------	----

Device Address:

Bit/Word	Device type	Format	Range	Memo
B	SM	DDDD	0 ~ 2047	
B	X	HHHH	0 ~ 1fff	Input Relay
B	Y	HHHH	0 ~ 1fff	Output Relay
B	M	DDDD	0 ~ 8191	Internal Relay
B	L	DDDD	0 ~ 8191	Latch Relay
B	F	DDDD	0 ~ 2047	Annunciator
B	V	DDDD	0 ~ 2047	Edge Relay
B	B	HHHH	0 ~ 1fff	Link Relay
B	SB	HHH	0 ~ 7ff	Special Link Relay
B	D_Bit	DDDDDh	0 ~ 12287f	
W	SD	DDDD	0 ~ 2047	
W	D	DDDDD	0 ~ 12287	Data Register
W	W	HHHH	0 ~ 1fff	Link Register
W	SW	HHH	0 ~ 7ff	Special Link Register
W	Z	DD	0 ~ 19	Index Register
W	R	DDDDD	0 ~ 32767	
W	C	DDDD	0 ~ 1023	Counter Current Value

Bit/Word	Device type	Format	Range	Memo
W	T	DDDD	0 ~ 2047	Timer Current Value

Note:



EasyBuilder doesn't support MITSUBISHI Q02U CPU to do on-line simulation on PC. When using Q02U driver, HMI needs 10 seconds to initiate PLC Q02U driver. Before the completion of initiation, it is recommended not to write data to PLC, this could cause "PLC no response" ; Incorrect wiring or data could cause PLC to be locked. If PLC is locked, please restart PLC or reinstall PLC module.

Wiring Diagram:





The following represents the view of HMI & PLC.

9P D-Sub to 6P Mini-DIN: Q02 CPU port RS232



eMT3000 series

COM1 RS232 9P D-Sub Female	COM3 RS232 9P D-Sub Female		RS232 6P Mini-DIN Male
2 RX	8 RX		3 TXD
3 TX	7 TX		4 RXD
5 GND	5 GND		5 GND
			1 RTS
			6 CTS
			circuit
			

MT6000/8000 series except MT6050i/MT8050i

COM1 RS232 9P D-Sub Female	COM2 RS232 9P D-Sub Female	COM3 RS232 9P D-Sub Male	RS232 6P Mini-DIN Male
2 RX	6 RX	8 RX	3 TXD
3 TX	4 TX	7 TX	4 RXD
5 GND	5 GND	5 GND	5 GND
			1 RTS
			6 CTS
			circuit
			

MT6050i/MT8050i

COM1 RS232 9P D-Sub Female			RS232 6P Mini-DIN Male
9 RX			3 TXD
6 TX			4 RXD
5 GND			5 GND
			1 RTS
			6 CTS
			circuit
			

Driver Version:

Version	Date	Description
V1.60	Jun/08/2011	Added register D_bit

Mitsubishi Q00UJ/QnU/QnUD/QnUDH/QnUDEH/L (mini USB)

Supported Series: Mitsubishi Q00UJ, Q00U, Q01U, Q02U, Q03UDE, Q03UD, Q04UDEH, Q04UDH, Q06UDEH, Q06UDH, Q10UDEH, Q10UDH, Q13UDEH, Q13UDH, Q20UDEH, Q20UDH, Q26UDEH, Q26UDH, L02, L26-BT USB Port.

HMI Setting:

Parameters	Recommended	Options	Notes
PLC type	Mitsubishi Q00UJ/QnU/QnUD/QnUDH/QnUDEH/L (mini USB)		
PLC I/F	USB		CPU port direct connect

Device Address:

Bit/Word	Device type	Format	Range	Memo
B	SM	DDDD	0 ~ 2047	
B	X	HHHH	0 ~ 1fff	Input Relay
B	Y	HHHH	0 ~ 1fff	Output Relay
B	M	DDDD	0 ~ 8191	Internal Relay
B	L	DDDD	0 ~ 8191	Latch Relay
B	F	DDDD	0 ~ 2047	Annunciator
B	V	DDDD	0 ~ 2047	Edge Relay
B	B	HHHH	0 ~ 1fff	Link Relay
B	SB	HHH	0 ~ 7ff	Special Link Relay
B	D_Bit	DDDDh	0 ~ 12287f	
W	SD	DDDD	0 ~ 2047	
W	D	DDDDD	0 ~ 12287	Data Register
W	W	HHHH	0 ~ 1fff	Link Register
W	SW	HHH	0 ~ 7ff	Special Link Register
W	Z	DD	0 ~ 19	Index Register
W	R	DDDDD	0 ~ 32767	
W	C	DDDD	0 ~ 1023	Counter Current Value
W	T	DDDD	0 ~ 2047	Timer Current Value

Note:

EasyBuilder doesn't support MITSUBISHI Q02U CPU to do on-line simulation on PC. When using Q02U driver, HMI needs 10 seconds to initiate PLC Q02U driver. Before the completion of initiation, it is recommended not to write data to PLC, this could cause "PLC no response" ; Incorrect wiring or data could cause PLC to be locked. If PLC is locked, please restart PLC or reinstall PLC module.

Driver Version:

Version	Date	Description
V1.30	Jun/08/2011	Added register D_bit

Mitsubishi Q02/02H

Supported Series; Mitsubishi Q02/Q02H CPU port.

Website: <http://www.mitsubishi-automation.com>

HMI Setting:

Parameters	Recommended	Options	Notes
PLC type	Mitsubishi Q02/02H		
PLC I/F	RS232	RS485 4W, RS232	
Baud rate	115200	115200 only	
Data bits	8		
Parity	Odd		
Stop bits	1		
PLC sta. no.	0		

Online simulator	YES	Extend address mode	NO
Broadcast command	NO		

Device Address:

Bit/Word	Device type	Format	Range	Memo
B	X	HHHH	0 ~ 1fff	Input Relay
B	Y	HHHH	0 ~ 1fff	Output Relay
B	M	DDDD	0 ~ 8191	Internal Relay
B	L	DDDD	0 ~ 8191	Latch Relay
B	F	DDDD	0 ~ 2047	Annunciator
B	V	DDDD	0 ~ 2047	Edge Relay
B	B	HHHH	0 ~ 1fff	Link Relay
B	TC	DDDD	0 ~ 2047	Timer Coil
B	SS	DDDD	0 ~ 2047	Retentive Timer Contact
B	SC	DDDD	0 ~ 2047	Retentive Timer Coil
B	CS	DDDD	0 ~ 1023	Counter Contact
B	CC	DDDD	0 ~ 1023	Counter Coil
B	SB	HHH	0 ~ 7ff	Special Link Relay
B	S	DDDD	0 ~ 8191	Step Relay



Bit/Word	Device type	Format	Range	Memo
B	DX	HHHH	0 ~ 1fff	Direct Input
B	DY	HHHH	0 ~ 1fff	Direct Output
B	TS	DDDD	0 ~ 2047	Timer Contact
B	D_Bit	DDDDh	0 ~ 12287f	
W	W	HHHH	0 ~ 1fff	Link Register
W	TN	DDDD	0 ~ 2047	Timer Current Value
W	SN	DDDD	0 ~ 2047	Retentive Timer Current Value
W	CN	DDDD	0 ~ 1023	Counter Current Value
W	R	DDDDD	0 ~ 32767	File Register
W	SW	HHH	0 ~ 7ff	Special Link Register
W	Z	DD	0 ~ 15	Index Register
W	ZR	HHHH	0 ~ ffff	File Register
W	D	DDDDD	0 ~ 12287	Data Register

Wiring Diagram:





The following represents the view of HMI & PLC.

9P D-Sub to 6P Mini-DIN: Q02 CPU port RS232



eMT3000 series

COM1 RS232 9P D-Sub Female	COM3 RS232 9P D-Sub Female		RS232 6P Mini-DIN Male
2 RX	8 RX		3 TXD
3 TX	7 TX		4 RXD
5 GND	5 GND		5 GND
			1 RTS
			6 CTS
			circuit
			

MT6000/8000 series except MT6050i/MT8050i

COM1 RS232 9P D-Sub Female	COM2 RS232 9P D-Sub Female	COM3 RS232 9P D-Sub Male	RS232 6P Mini-DIN Male
2 RX	6 RX	8 RX	3 TXD
3 TX	4 TX	7 TX	4 RXD
5 GND	5 GND	5 GND	5 GND
			1 RTS
			6 CTS
			circuit
			

MT6050i/MT8050i

COM1 RS232 9P D-Sub Female			RS232 6P Mini-DIN Male
9 RX			3 TXD
6 TX			4 RXD
5 GND			5 GND
			1 RTS
			6 CTS
			circuit
			

Driver Version:

Version	Date	Description
V1.60	Jun/08/2011	Added register D_bit

Mitsubishi Q06H

Supported Series: Mitsubishi Q06H CPU port.

Website: <http://www.mitsubishi-automation.com>

HMI Setting:

Parameters	Recommended	Options	Notes
PLC type	Mitsubishi Q06H		
PLC I/F	RS232	RS485 4W, RS232	
Baud rate	115200	115200 only	
Data bits	8		
Parity	Odd		
Stop bits	1		
PLC sta. no.	0		

Online simulator	YES	Extend address mode	NO
Broadcast command	NO		

Device Address:

Bit/Word	Device type	Format	Range	Memo
B	X	HHHH	0 ~ 1fff	Input Relay
B	Y	HHHH	0 ~ 1fff	Output Relay
B	M	DDDD	0 ~ 8191	Internal Relay
B	L	DDDD	0 ~ 8191	Latch Relay
B	F	DDDD	0 ~ 2047	Annunciator
B	V	DDDD	0 ~ 2047	Edge Relay
B	B	HHHH	0 ~ 1fff	Link Relay
B	TC	DDDD	0 ~ 2047	Timer Coil
B	SS	DDDD	0 ~ 2047	Retentive Timer
B	SC	DDDD	0 ~ 2047	Retentive Timer Coil
B	CS	DDDD	0 ~ 1023	Counter Contact
B	CC	DDDD	0 ~ 1023	Counter Coil
B	SB	HHH	0 ~ 7ff	Special Link Relay
B	S	DDDD	0 ~ 8191	Step Relay



Bit/Word	Device type	Format	Range	Memo
B	DX	HHHH	0 ~ 1fff	Direct Input
B	DY	HHHH	0 ~ 1fff	Direct Output
B	TS	DDDD	0 ~ 2047	Timer Contact
B	D_Bit	DDDDh	0 ~ 12287f	
W	W	HHHH	0 ~ 1fff	Link Register
W	TN	DDDD	0 ~ 2047	Timer Current Value
W	SN	DDDD	0 ~ 2047	Retentive Timer
W	CN	DDDD	0 ~ 1023	Counter Current Value
W	R	DDDDD	0 ~ 32767	File Register
W	SW	HHH	0 ~ 7ff	Special Link Register
W	Z	DD	0 ~ 15	Index Register
W	ZR	HHHH	0 ~ ffff	File Register
W	D	DDDDD	0 ~ 12287	Data Register

Wiring Diagram:





The following represents the view of HMI & PLC.

9P D-Sub to 6P Mini-DIN: Q02 CPU port RS232



eMT3000 series

COM1 RS232 9P D-Sub Female	COM3 RS232 9P D-Sub Female		RS232 6P Mini-DIN Male
2 RX	8 RX		3 TXD
3 TX	7 TX		4 RXD
5 GND	5 GND		5 GND
			1 RTS
			6 CTS
			circuit
			

MT6000/8000 series except MT6050i/MT8050i

COM1 RS232 9P D-Sub Female	COM2 RS232 9P D-Sub Female	COM3 RS232 9P D-Sub Male	RS232 6P Mini-DIN Male
2 RX	6 RX	8 RX	3 TXD
3 TX	4 TX	7 TX	4 RXD
5 GND	5 GND	5 GND	5 GND
			1 RTS
			6 CTS
			circuit
			

MT6050i/MT8050i

COM1 RS232 9P D-Sub Female			RS232 6P Mini-DIN Male
9 RX			3 TXD
6 TX			4 RXD
5 GND			5 GND
			1 RTS
			6 CTS
			circuit
			

Driver Version:

Version	Date	Description
V1.60	Jun/08/2011	Added register D_bit

Mitsubishi QJ71E71 (Ethernet)

Supported Series ; Mitsubishi Q type, MELSEC-Q series PLC (Q00J, Q00, Q01, Q02, Q02H, Q06H, Q12H, Q25H, Q12PH, Q25PH) QJ71E71-100 Ethernet module.

Website: <http://www.mitsubishi-automation.com>

HMI Setting:

Parameters	Recommended	Options	Notes
PLC type	Mitsubishi QJ71E71 (Ethernet)		
PLC I/F	Ethernet		
Port no.	5002		
PLC sta. no.	2	1~99	

Note: MITSUBISHI QJ71E71 only supports PLC Network No. 1.

If PLC Network No. is not 1, please use “MITSUBISHI MELSEC-Q(Ethernet)” driver and fill in the Network No. in Parameter 1. Please refer to MITSUBISHI MELSEC-Q(Ethernet) for further information.

PLC Setting:

QJ71E71-100 Ethernet module settings:

1. Use USB or RS232 of Q-CPU for setting PLC parameters.

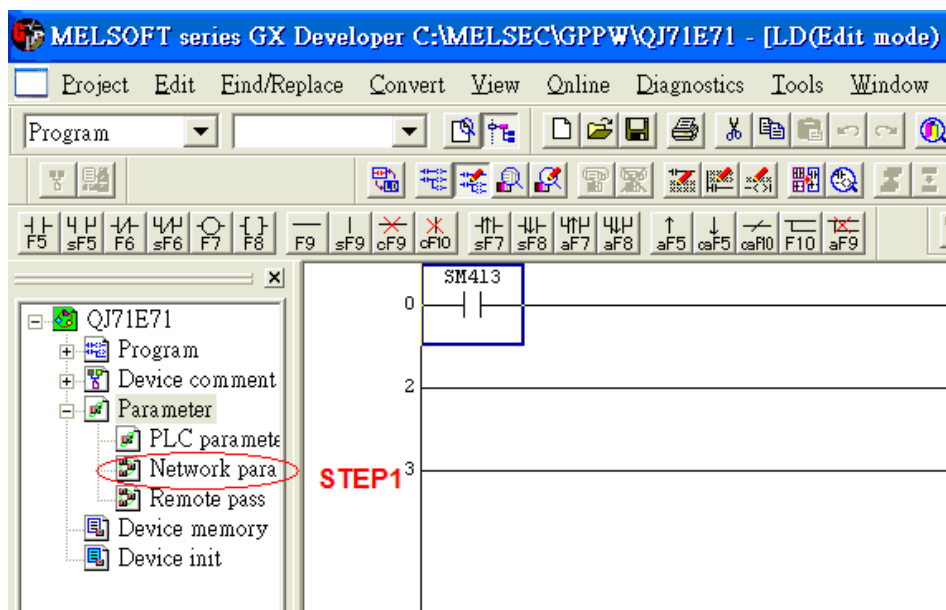

2. Click [Operational settings] to set IP information.

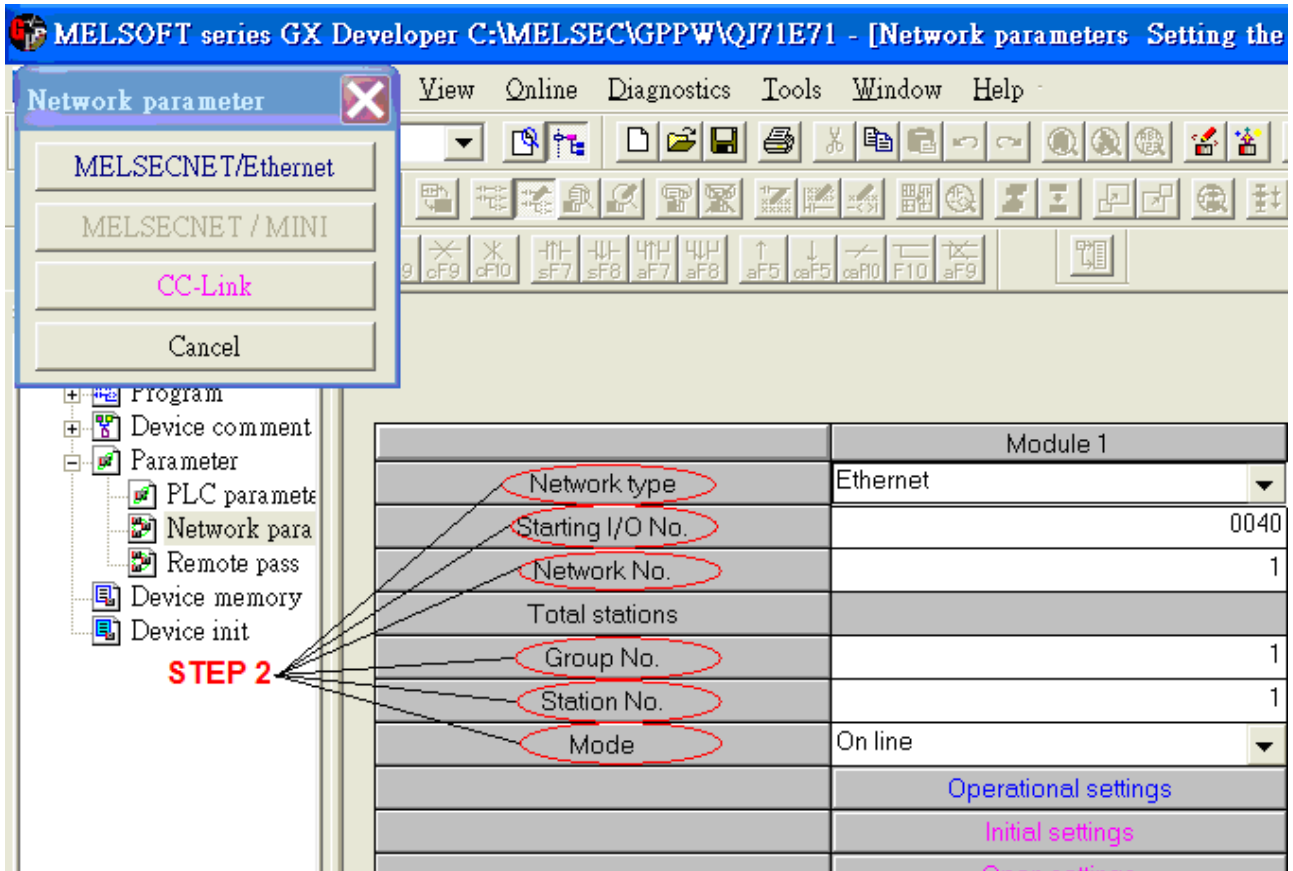

	Module 1	Module 2
Network type	Ethernet	None
Starting I/O No.	0040	
Network No.	1	
Total stations		
Group No.	1	
Station No.	1	
Mode	On line	
	Operational settings	
	Initial settings	
	Open settings	
	Router relay parameter	
	Station No. <-> IP information	
	FTP Parameters	
	E-mail settings	
	Interrupt settings	

3. Select Ethernet (2.0) for communicating with HMI.

Ethernet operations

Communication data code
 Binary code
 ASCII code

Initial timing
 Do not wait for OPEN (Communications impossible at STOP time)
Always wait for OPEN \
 Communication possible at STOP time

IP address
 Input format: DEC
 IP address: 192 | 168 | 10 | 105

Send frame setting
 Ethernet(V2.0)
 IEEE802.3

Enable Write at RUN time

TCP Existence confirmation setting
 Use the KeepAlive
 Use the Ping

Buttons: End, Cancel

4. Click [Open settings] to set the system.

	Module 1	Module 2
Network type	Ethernet	None
Starting I/O No.	0040	
Network No.	1	
Total stations		
Group No.	1	
Station No.	1	
Mode	On line	
	Operational settings	
	Initial settings	
	STEP 4 Open settings	
	Router relay parameter	
	Station No. <-> IP information	
	FTP Parameters	
	E-mail settings	
	Interrupt settings	

Port No. input focus: HEX

	Protocol	Open system	Fixed buffer	Fixed buffer communication procedure	Peering open	Existence confirmation	Host station Port No.	Transmission target device IP address	Transmission target device Port No.
1	TCP	Active	Send	Procedure exist	Disable	No confirm	5002	No Settings	
2	TCP	Active	Send	Procedure exist	Disable	No confirm	5003	No Settings	
3	TCP	Active	Send	Procedure exist	Disable	No confirm	5004	No Settings	
4									
5									
6									
7									
8									
9									
10									
11									
12									
13									
14									
15									
16									

Buttons: End, Cancel

- Press [END] to finish settings.

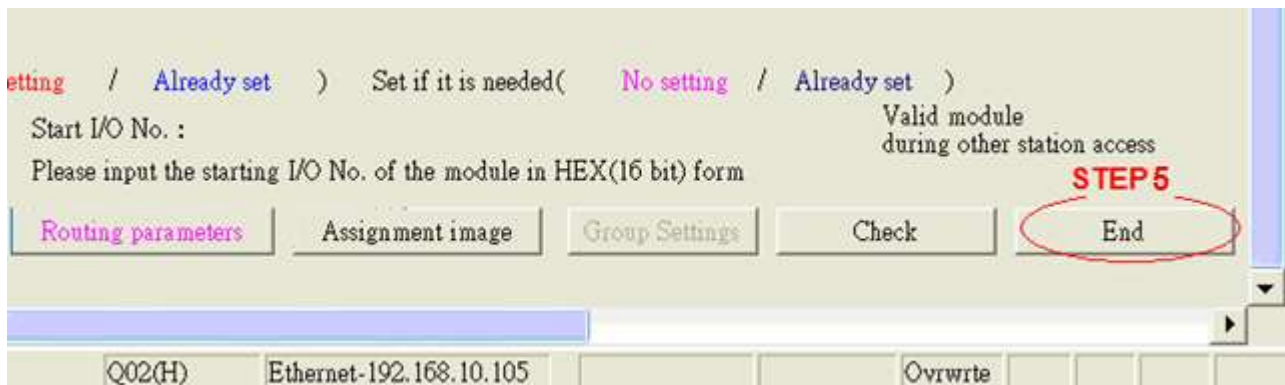

- Restart PLC software and select [READ FROM PLC], select [QCPU(Qmode)] and press [OK].

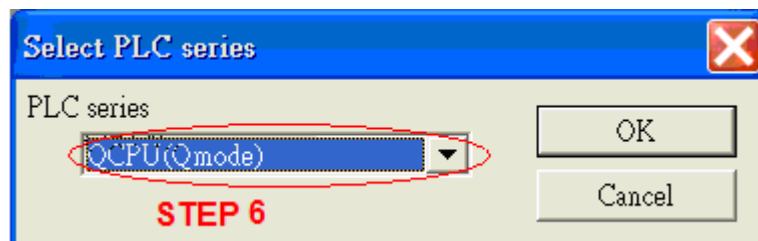

- In [PC side I/F Ethernet board setting] set Network No. and Station No. (Station No.1 is PC Station No. not Ethernet module Station No., ranged from 2~64, the Network No. can not be the same as that of PC)

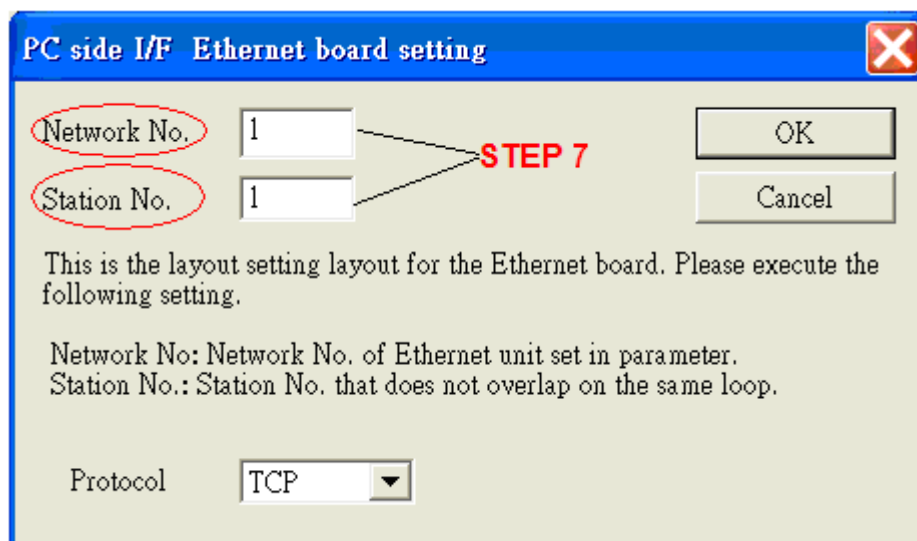

- Select "Ethernet module" in PLC Side I/F to set QJ71E71 IP address.(IP address = Network Parameter IP address)

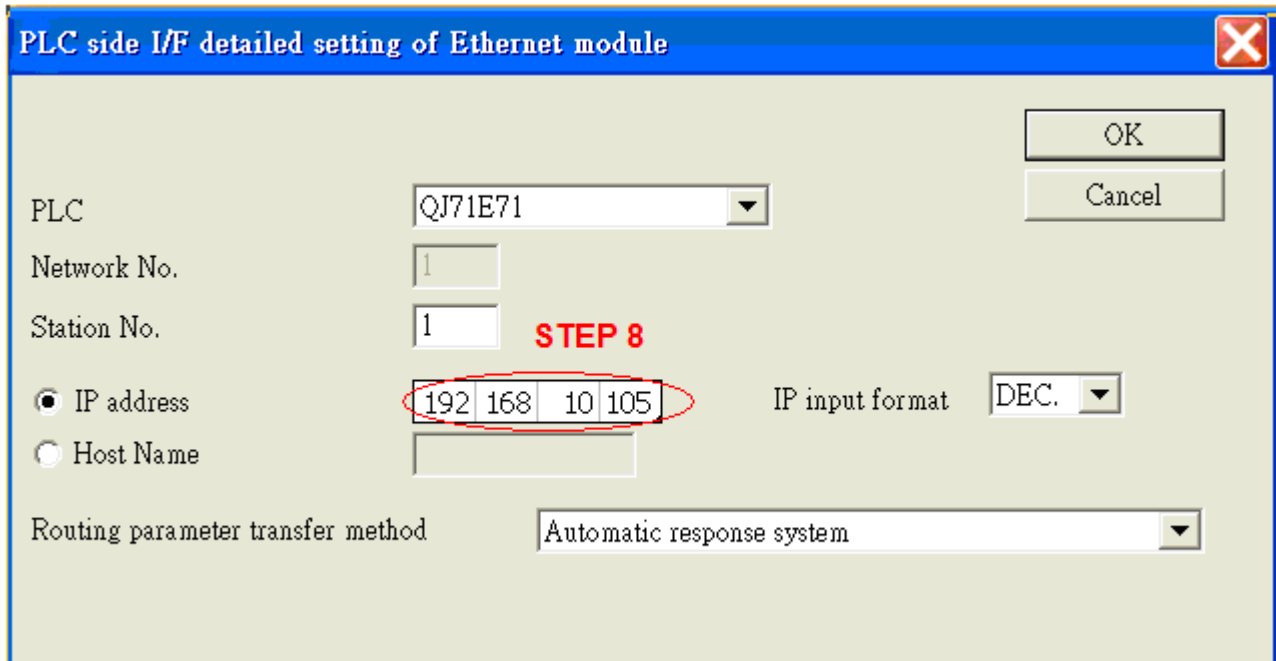

PLC side I/F detailed setting of Ethernet module

PLC: QJ71E71

Network No.: 1

Station No.: 1

IP address: 192.168.10.105 (STEP 8) IP input format: DEC.

Host Name:

Routing parameter transfer method: Automatic response system

Buttons: OK, Cancel

- For "Other station", click [Other station(Single network)] for setting [Check at communication time] and [Retry times].

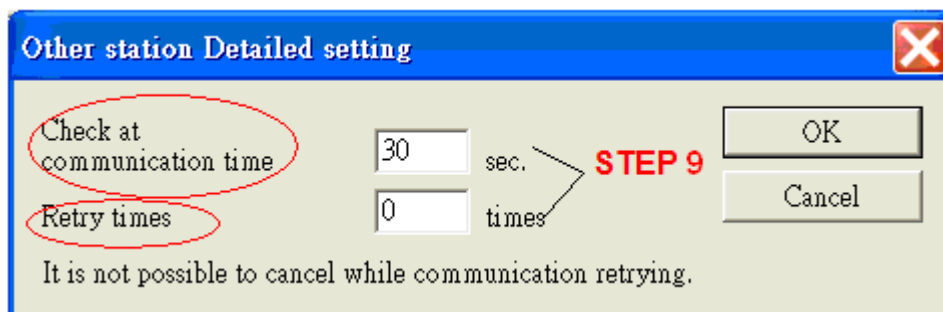

Other station Detailed setting

Check at communication time: 30 sec.

Retry times: 0 times (STEP 9)

It is not possible to cancel while communication retrying.

Buttons: OK, Cancel

- After finishing the settings above, click [Connection test] for testing the communication and sending the PLC program.

Device Address:

Bit/Word	Device type	Format	Range	Memo
B	SM	DDDD	0 ~ 2047	
B	X	HHHH	0 ~ 1fff	Input Relay
B	Y	HHHH	0 ~ 1fff	Output Relay
B	M	DDDD	0 ~ 8191	Internal Relay
B	L	DDDD	0 ~ 8191	Latch Relay
B	F	DDDD	0 ~ 2047	Annunciator
B	V	DDDD	0 ~ 2047	Edge Relay
B	B	HHHH	0 ~ 1fff	Link Relay
B	TS	DDDD	0 ~ 2047	
B	TC	DDDD	0 ~ 2047	
B	SS	DDDD	0 ~ 2047	
B	SC	DDDD	0 ~ 2047	
B	CS	DDDD	0 ~ 1023	
B	CC	DDDD	0 ~ 1023	
B	SB	HHH	0 ~ 7ff	Special Link Relay
B	S	DDDD	0 ~ 8191	
B	DX	HHHH	0 ~ 1fff	Direct Input
B	DY	HHHH	0 ~ 1fff	Direct Output
B	D_Bit	DDDDh	0 ~ 12287f	
W	SD	DDDD	0 ~ 2047	
W	D	DDDDD	0 ~ 12287	Data Register
W	W	HHHH	0 ~ 1fff	Link Register
W	TN	DDDD	0 ~ 2047	
W	SN	DDDD	0 ~ 2047	
W	CN	DDDD	0 ~ 1023	
W	SW	HHH	0 ~ 7ff	Special Link Register
W	Z	DD	0 ~ 15	Index Register
W	R	DDDDD	0 ~ 32767	File Register
W	ZR	HHHHH	0 ~ fe7ff	File Register

Wiring Diagram:

Direct connect (crossover cable):

HMI RJ45 Male	Wire Color	Wire Color	PLC RJ45 Male
1 TX+	White/Orange	White/Green	3 RX+
2 TX-	Orange	Green	6 RX-
3 RX+	White/Green	White/Orange	1 TX+
4 BD4+	Blue	Blue	4 BD4+
5 BD4-	White/Blue	White/Blue	5 BD4-
6 RX-	Green	Orange	2 TX-
7 BD3+	White/Brown	White/Brown	7 BD3+
8 BD3-	Brown	Brown	8 BD3-



Through a hub:

HMI RJ45 Male	Wire Color	Wire Color	PLC RJ45 Male
1 TX+	White/Orange	White/Orange	1 TX+
2 TX-	Orange	Orange	2 TX-
3 RX+	White/Green	White/Green	3 RX+
4 BD4+	Blue	Blue	4 BD4+
5 BD4-	White/Blue	White/Blue	5 BD4-
6 RX-	Green	Green	6 RX-
7 BD3+	White/Brown	White/Brown	7 BD3+
8 BD3-	Brown	Brown	8 BD3-



Driver Version:

Version	Date	Description
V2.20	Jun/08/2011	Added register: D_bit

MODBUS ASCII

Supported Series: MODBUS ASCII CONTROLLER

Website: <http://www.modbus.org>

HMI Setting:

Parameters	Recommended	Options	Notes
PLC type	MODBUS ASCII		
PLC I/F	RS485	RS232/RS485	
Baud rate	9600	9600/19200/38400/ 57600/115200	
Data bits	8	7,8	
Parity	Even	Even, Odd, None	
Stop bits	1	1,2	
PLC sta. no.	1	0-255	

Online simulator	YES	Broadcast command	YES
Extend address mode	YES		

PLC Setting:

Communication mode	Modbus ASCII protocol
--------------------	-----------------------

Device Address:

Bit/Word	Device type	Format	Range	Memo
B	1x	DDDDD	1 ~ 65535	Input bit (read only)
B	0x	DDDDD	1 ~ 65535	Output bit
B	3x_Bit	DDDDDdd	100 ~ 6553515	Input Register bit (read only)
B	4x_Bit	DDDDDdd	100 ~ 6553515	Output Register bit
W	3x	DDDDD	1 ~ 65535	Input Register (read only)
W	4x	DDDDD	1 ~ 65535	Output Register
W	6x	DDDDD	1 ~ 65535	

Modbus RTU function code:

0x	0x01 Read coil	0x05 write single coil
1x	0x02 Read discrete input	N/A for write operation
3x	0x04 Read input register	N/A for write operation
4x	0x03 Read holding register	0x10 write multiple registers

3xbit is equivalent to 3x



4xbit is equivalent to 4x

Wiring Diagram:





The following represents the view of HMI & PLC.

Modbus ASCII Controller : RS232



eMT3000 series

COM1 RS232 9P D-Sub Female	COM3 RS232 9P D-Sub Female		RS232 9P D-Sub Female
2 RX	8 RX		TXD
3 TX	7 TX		RXD
5 GND	5 GND		GND
			RTS
			CTS
			circuit
			

MT6000/8000 series except MT6050i/MT8050i

COM1 RS232 9P D-Sub Female	COM2 RS232 9P D-Sub Female	COM3 RS232 9P D-Sub Male	RS232 9P D-Sub Female
2 RX	6 RX	8 RX	TXD
3 TX	4 TX	7 TX	RXD
5 GND	5 GND	5 GND	GND
			RTS
			CTS
			circuit
			



MT6050i/MT8050i

COM1 RS232 9P D-Sub Female			RS232 9P D-Sub Female
9 RX			TXD
6 TX			RXD
5 GND			GND
			RTS
			CTS
			circuit
			



The following represents the view of HMI & PLC.

Modbus ASCII Controller : RS485 4W



eMT3000 series

COM1 RS485 4W 9P D-Sub Male			RS485 4W 9P D-Sub Male
1 RX-			TX-
2 RX+			TX+
3 TX-			RX-
4 TX+			RX+
5 GND			GND
			

MT6000/8000 series except MT6050i/MT8050i

COM1 RS485 4W 9P D-Sub Male			RS485 4W 9P D-Sub Male
1 RX-			TX-
2 RX+			TX+
3 TX-			RX-
4 TX+			RX+
5 GND			GND
			



MT6050i/MT8050i

COM1 RS485 4W 9P D-Sub Female			RS485 4W 9P D-Sub Female
1 RX-			TX-
2 RX+			TX+
3 TX-			RX-
4 TX+			RX+
5 GND			GND
			



The following represents the view of HMI & PLC.

Modbus ASCII Controller : RS485 2W



eMT3000 series

COM1 RS485 2W 9P D-Sub Male	COM3 RS485 2W 9P D-Sub Male		RS485 2W 9P D-Sub Male
1 RX-	6 Data-		D-
2 RX+	9 Data+		D+
5 GND	5 GND		GND
			

MT6000/8000 series except MT6050i/MT8050i

COM1 RS485 2W 9P D-Sub Male	COM3 RS485 2W 9P D-Sub Male		RS485 2W 9P D-Sub Male
1 RX-	6 Data-		D-
2 RX+	9 Data+		D+
5 GND	5 GND		GND
			

MT6050i/MT8050i

COM1 RS485 2W 9P D-Sub Female	COM3 RS485 2W 9P D-Sub Female		RS485 2W 9P D-Sub Female
1 RX-	7 Data-		D-
2 RX+	8 Data+		D+
5 GND	5 GND		GND
			

Driver Version:

Version	Date	Description
V1.40	Apr/17/2009	

MODBUS ASCII Server

HMI Setting:

Parameters	Recommended	Options	Notes
PLC type	MODBUS ASCII Server		
PLC I/F	RS232	RS232, RS485	
Baud rate	9600	9600~115200	
Data bits	8	7,8	
Parity	Even	Even, Odd, None	
Stop bits	1	1	
PLC sta. no.	1	1-31	HMI Modbus Station No.

Online simulator	YES	Extend address mode	NO
Broadcast command	NO		

PLC Setting:

Communication mode	Modbus ASCII protocol
--------------------	-----------------------

Device Address:

Bit/Word	Device type	Format	Range	Memo
B	LB	dddd	0 ~ 9998	Mapping to 0x/1x 1 ~ 9999
W	LW	dddd	0 ~ 9998	Mapping to 3x/4x 1 ~ 9999
W	RW	dddddd	0 ~ 55536	Mapping to 3x/4x 10000 ~ 65536

LB0 = 0x0001, LB1 = 0x0002, LW0 = 3x0001, LW1 = 3x0002

Modbus RTU Server doesn't support function code 06(preset single register), please use function code 16(0x10, preset multiple registers).

Modbus Server Function Code:



0x	0x01	Read coil	0x05	write single coil
0x_multi_coils	0x01	Read coil	0x0f	write multiple coils
1x	0x02	Read discrete input	N/A	for write operation
3x	0x04	Read input register	N/A	for write operation
4x	0x03	Read holding register	0x10	write multiple registers

Wiring Diagram:



The following represents the view of HMI & PLC.

RS232



eMT3000 series

COM1 RS232 9P D-Sub Female	COM3 RS232 9P D-Sub Female		RS232 9P D-Sub Female
2 RX	8 RX		TXD
3 TX	7 TX		RXD
5 GND	5 GND		GND
			RTS
			CTS
			circuit
			

MT6000/8000 series except MT6050i/MT8050i

COM1 RS232 9P D-Sub Female	COM2 RS232 9P D-Sub Female	COM3 RS232 9P D-Sub Male	RS232 9P D-Sub Female
2 RX	6 RX	8 RX	TXD
3 TX	4 TX	7 TX	RXD
5 GND	5 GND	5 GND	GND
			RTS
			CTS
			circuit
			



MT6050i/MT8050i

COM1 RS232 9P D-Sub Female			RS232 9P D-Sub Female
9 RX			TXD
6 TX			RXD
5 GND			GND
			RTS
			CTS
			circuit
			



The following represents the view of HMI & PLC.

RS485 4W



eMT3000 series

COM1 RS485 4W 9P D-Sub Male			RS485 4W 9P D-Sub Male
1 RX-			TX-
2 RX+			TX+
3 TX-			RX-
4 TX+			RX+
5 GND			GND
			

MT6000/8000 series except MT6050i/MT8050i

COM1 RS485 4W 9P D-Sub Male			RS485 4W 9P D-Sub Male
1 RX-			TX-
2 RX+			TX+
3 TX-			RX-
4 TX+			RX+
5 GND			GND
			



MT6050i/MT8050i

COM1 RS485 4W 9P D-Sub Female			RS485 4W 9P D-Sub Female
1 RX-			TX-
2 RX+			TX+
3 TX-			RX-
4 TX+			RX+
5 GND			GND
			



The following represents the view of HMI & PLC.

RS485 2W



eMT3000 series

COM1 RS485 2W 9P D-Sub Male	COM3 RS485 2W 9P D-Sub Male		RS485 2W 9P D-Sub Male
1 RX-	6 Data-		D-
2 RX+	9 Data+		D+
5 GND	5 GND		GND
			

MT6000/8000 series except MT6050i/MT8050i

COM1 RS485 2W 9P D-Sub Male	COM3 RS485 2W 9P D-Sub Male		RS485 2W 9P D-Sub Male
1 RX-	6 Data-		D-
2 RX+	9 Data+		D+
5 GND	5 GND		GND
			

MT6050i/MT8050i

COM1 RS485 2W 9P D-Sub Female	COM3 RS485 2W 9P D-Sub Female		RS485 2W 9P D-Sub Male
1 RX-	7 Data-		D-
2 RX+	8 Data+		D+
5 GND	5 GND		GND
			

Note: Setting more than one Modbus ASCII Server in HMI Device List is of no effect.

Driver Version:

Version	Date	Description
V1.00	Feb/19/2009	Driver released

MODBUS RTU

Supported Series : MODBUS RTU CONTROLLER

Website : <http://www.modbus.org>

HMI Setting:

Parameters	Recommended	Options	Notes
PLC type	MODBUS RTU		
PLC I/F	RS485	RS232/RS485	
Baud rate	9600	9600~115200	
Data bits	8	7, 8	
Parity	Even	Even, Odd, None	
Stop bits	1	1, 2	
PLC sta. no.	1	0-255	

Online simulator	YES	Broadcast command	YES
Extend address mode	YES		

PLC Setting:

Communication mode	Modbus RTU protocol
--------------------	---------------------

Device Address:

Bit/Word	Device type	Format	Range	Memo
B	0x	DDDDD	1 ~ 65535	Output bit
B	1x	DDDDD	1 ~ 65535	Input bit (read only)
B	3x_Bit	DDDDDdd	100 ~ 6553515	Input Register bit (read only)
B	4x_Bit	DDDDDdd	100 ~ 6553515	Output Register bit
B	6x_Bit	DDDDDdd	100 ~ 6553515	Output Register bit
B	0x_multi_coils	DDDDD	1 ~ 65535	Write multiple coils
W	3x	DDDDD	1 ~ 65535	Input Register (read only)
W	4x	DDDDD	1 ~ 65535	Output Register
DW	5x	DDDDD	1 ~ 65535	4x double word swap
W	6x	DDDDD	1 ~ 65535	4x single word write
W	4x_32Bit*	DDDDD	1 ~ 65535	Output Register

4x_32Bit will only read / write 2 words for each package, for continuous addresses, it will be divided into several packages.

NOTE:

Address type “5x” is mapping to Hold Reg. The communication protocol of 5x is almost the same as “4x” except that “5x” swaps double word.

If 4x contains the following information:

Address	1	2	3	4	5	6	...
Data in word	0x1	0x2	0x3	0x4	0x5	0x6	
Data	0x20001		0x40003		0x60005		

For 5x, it will be:

Address	1	2	3	4	5	6	...
Data in word	0x2	0x1	0x4	0x3	0x6	0x5	
Data	0x10002		0x30004		0x50006		

Modbus RTU function code:

0x	0x01	Read coil	0x05	write single coil
0x_multi_coils	0x01	Read coil	0x0f	write multiple coils
1x	0x02	Read discrete input	N/A	for write operation
3x	0x04	Read input register	N/A	for write operation
4x	0x03	Read holding register	0x10	write multiple registers
5x	0x03	Read holding register	0x10	write multiple registers

(Note: reverse word order in double word format)

3xbit is equivalent to 3x

4xbit is equivalent to 4x

6x	0x03	Read holding register	0x06	write single register
----	------	-----------------------	------	-----------------------



(Note: 6x is limited to device of one word only)

Wiring Diagram:





The following represents the view of HMI & PLC.

MODBUS RTU CONTROLLER : RS232



eMT3000 series

COM1 RS232 9P D-Sub Female	COM3 RS232 9P D-Sub Female		RS232 9P D-Sub FeMale
2 RX	8 RX		TXD
3 TX	7 TX		RXD
5 GND	5 GND		GND
			RTS
			CTS
			circuit
			

MT6000/8000 series except MT6050i/MT8050i

COM1 RS232 9P D-Sub Female	COM2 RS232 9P D-Sub Female	COM3 RS232 9P D-Sub Male	RS232 9P D-Sub FeMale
2 RX	6 RX	8 RX	TXD
3 TX	4 TX	7 TX	RXD
5 GND	5 GND	5 GND	GND
			RTS
			CTS
			circuit
			



MT6050i/MT8050i

COM1 RS232 9P D-Sub Female			RS232 9P D-Sub FeMale
9 RX			TXD
6 TX			RXD
5 GND			GND
			RTS
			CTS
			circuit
			



The following represents the view of HMI & PLC.

MODBUS RTU CONTROLLER : RS485 4W



eMT3000 series

COM1 RS485 4W 9P D-Sub Male			RS485 4W 9P D-Sub Male
1 RX-			TX-
2 RX+			TX+
3 TX-			RX-
4 TX+			RX+
5 GND			GND
			

MT6000/8000 series except MT6050i/MT8050i

COM1 RS485 4W 9P D-Sub Male			RS485 4W 9P D-Sub Male
1 RX-			TX-
2 RX+			TX+
3 TX-			RX-
4 TX+			RX+
5 GND			GND
			



MT6050i/MT8050i

COM1 RS485 4W 9P D-Sub Female			RS485 4W 9P D-Sub Female
1 RX-			TX-
2 RX+			TX+
3 TX-			RX-
4 TX+			RX+
5 GND			GND
			



The following represents the view of HMI & PLC.

MODBUS RTU CONTROLLER : RS485 2W



eMT3000 series

COM1 RS485 2W 9P D-Sub Male	COM3 RS485 2W 9P D-Sub Male		RS485 2W 9P D-Sub Male
1 RX-	6 Data-		D-
2 RX+	9 Data+		D+
5 GND	5 GND		GND
			

MT6000/8000 series except MT6050i/MT8050i

COM1 RS485 2W 9P D-Sub Male	COM3 RS485 2W 9P D-Sub Male		RS485 2W 9P D-Sub Male
1 RX-	6 Data-		D-
2 RX+	9 Data+		D+
5 GND	5 GND		GND
			

MT6050i/MT8050i

COM1 RS485 2W 9P D-Sub Female	COM3 RS485 2W 9P D-Sub Female		RS485 2W 9P D-Sub Female
1 RX-	7 Data-		D-
2 RX+	8 Data+		D+
5 GND	5 GND		GND
			

Driver Version:

Version	Date	Description
V1.90	May/05/2010	Fixed when receiving data over 8 bytes from MODBUS RTU, LW-9570 fails to calculate correctly.

MODBUS RTU (0x/1x Range Adjustable)

Supported Series : MODBUS RTU CONTROLLER

Website : <http://www.modbus.org>

HMI Setting:

Parameters	Recommended	Options	Notes
PLC type	MODBUS RTU (0x/1x Range Adjustable)		
PLC I/F	RS485	RS232/RS485	
Baud rate	9600	9600~115200	
Data bits	8	7,8	
Parity	Even	Even, Odd, None	
Stop bits	1	1,2	
PLC sta. no.	1	0-255	

Online simulator	YES
Extend address mode	YES

PLC Setting:

Communication mode	Modbus RTU protocol
--------------------	---------------------

Device Address:

Bit/Word	Device type	Format	Range	Memo
B	0x	DDDDD	1 ~ 65535	Output bit
B	1x	DDDDD	1 ~ 65535	Input bit (read only)
B	3x_Bit	DDDDDdd	100 ~ 6553515	Input Register bit (read only)
B	4x_Bit	DDDDDdd	100 ~ 6553515	Output Register bit
B	6x_Bit	DDDDDdd	100 ~ 6553515	Output Register bit
B	0x_multi_coils	DDDDD	1 ~ 65535	Write multiple coils
W	3x	DDDDD	1 ~ 65535	Input Register (read only)
W	4x	DDDDD	1 ~ 65535	Output Register
DW	5x	DDDDD	1 ~ 65535	4x double word swap
W	6x	DDDDD	1 ~ 65535	4x single word write
W	4x_32Bit*	DDDDD	1 ~ 65535	Output Register

4x_32Bit will only read / write 2 words for each package, for continuous addresses, it will be divided into several packages.

NOTE:

Address type “5x” is mapping to Hold Reg. The communication protocol of “5x” is almost the same as “4x” except that “5x” swaps double words.

If 4x contains the following information:

Address	1	2	3	4	5	6	...
Data in word	0x1	0x2	0x3	0x4	0x5	0x6	
Data	0x20001		0x40003		0x60005		

For 5x, it will be:

Address	1	2	3	4	5	6	...
Data in word	0x2	0x1	0x4	0x3	0x6	0x5	
Data	0x10002		0x30004		0x50006		

Modbus RTU function code:

0x	0x01	Read coil	0x05	Write single coil
0x_multi_coils	0x01	Read coil	0x0f	Write multiple coils
1x	0x02	Read discrete input		N/A for writing operation
3x	0x04	Read input register		N/A for writing operation
4x	0x03	Read holding register	0x10	Write multiple registers
5x	0x03	Read holding register	0x10	Write multiple registers

(Note: reverse word order in double words format)

3xbit is equivalent to 3x

4xbit is equivalent to 4x

6x	0x03	Read holding register	0x06	Write single register
----	------	-----------------------	------	-----------------------

(Note: 6x is limited to device of one word only)

Setting Instructions:

1. Go to [System Parameter Settings]  , click [New] to add a new device -Modbus RTU (0x 1x range adjustable) , as shown below:

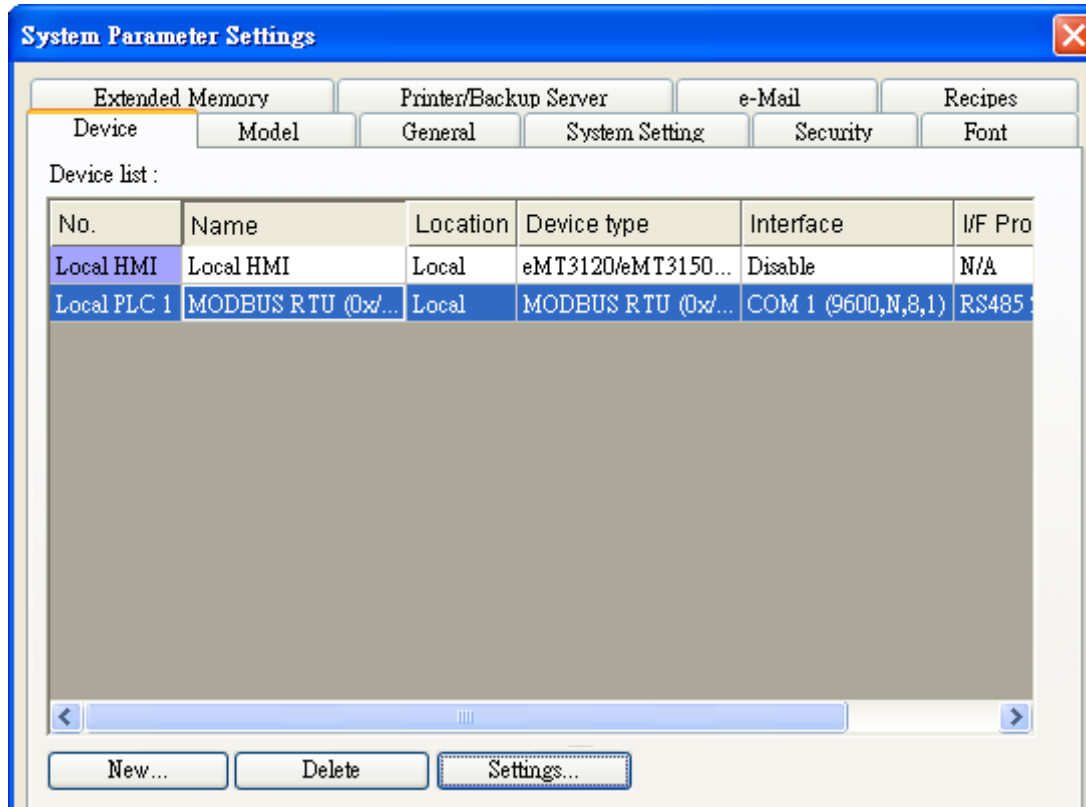

2. After adding Modbus RTU (0x 1x Range Adjustable) driver, [Add Address Range Limit] button will be enabled as below. Users can set maximum read/write command size here.

- Max.read-command size (words): Pull down to select PLC reading range.

Max. read-command size (words) :

- Max.write-command size (words): Pull down to select PLC writing range.

Max. write-command size (words) :

Note: Setting [Add Address Range Limit] is enabled only when bit address is not a multiple of 16bit.

Device Properties

Name : MODBUS RTU (0x/1x Range Adjustable)

HMI PLC

Location : Local Settings ...

PLC type : MODBUS RTU (0x/1x Range Adjustable)
V.1.20, MODBUS_RTU_RANGE_ADJUST.so

PLC I/F : RS-485 2W

COM : COM1 (9600,E,8,1) Settings...

PLC default station no. : 1
 Default station no. use station no. variable
 Use broadcast command

Interval of block pack (words) : 0 Add Address Range Limit...
Max. read-command size (words) : 1
Max. write-command size (words) : 1

OK Cancel

- Click [Add Address Range Limit] button, Users can define 0x and 1x address range in [0x 1x Address Range] dialog box, referring to bit range of the device used.

0x/1x Address Range

No.	Station no.	Device type	Min. address	Max. address
1	20	0x	1	36
2	2	0x	5	51

Add... Delete Settings... Exit

Add : Set [Station No.], [Device Type], [Min. Address], [Max. Address] then click [OK] to finish adding as below:

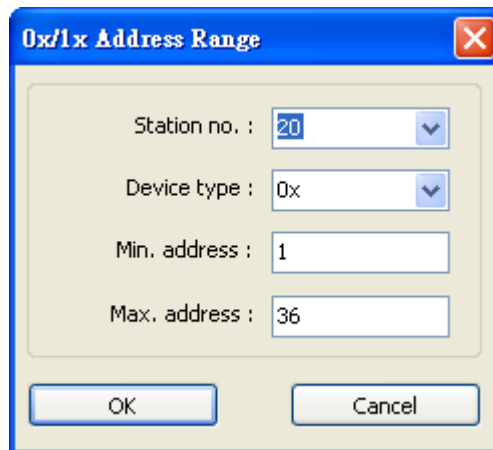

0x/1x Address Range

Station no. : 20

Device type : 0x

Min. address : 1

Max. address : 36

OK Cancel

Delete : The selected items will be deleted.

Settings : Set [Station No.], [Device Type], [Min. Address], [Max. Address] then click [OK] to finish adding as below:

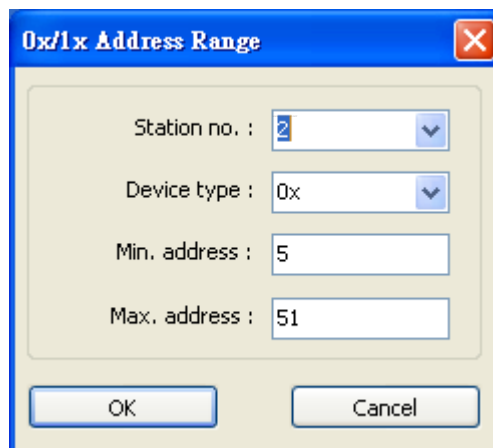

0x/1x Address Range

Station no. : 2

Device type : 0x

Min. address : 5

Max. address : 51

OK Cancel

Example :

Take D2 and D8 of SCON as example, the settings depend on bit range of different PLC types. Set [Station No.] and address first.

For D2, set [Station No.] to **20**, [Device Type] **0x**, [Max. Address] **36**.

For D8, set [Station No.] to **2**, [Device Type] **0x**, [Max. Address] **51**.

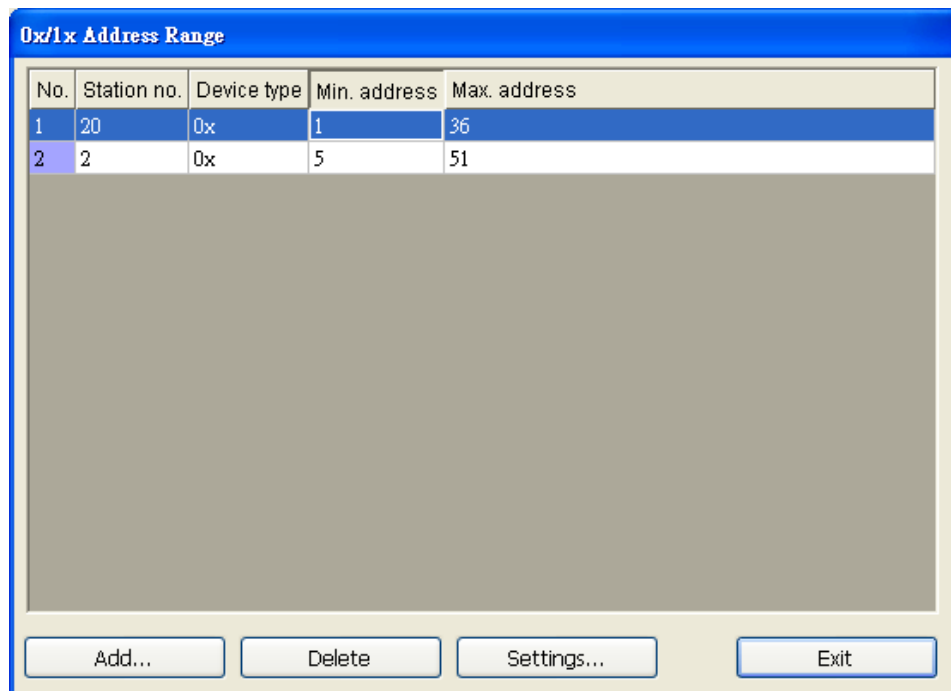

Note: If communicating with a RS-485 2W PLC, the [Turn around delay] setting may need to be adjusted according to the reply speed of the device. Please click [Settings] in [Device Properties], and set the [Turn around delay (ms)] parameter as shown:

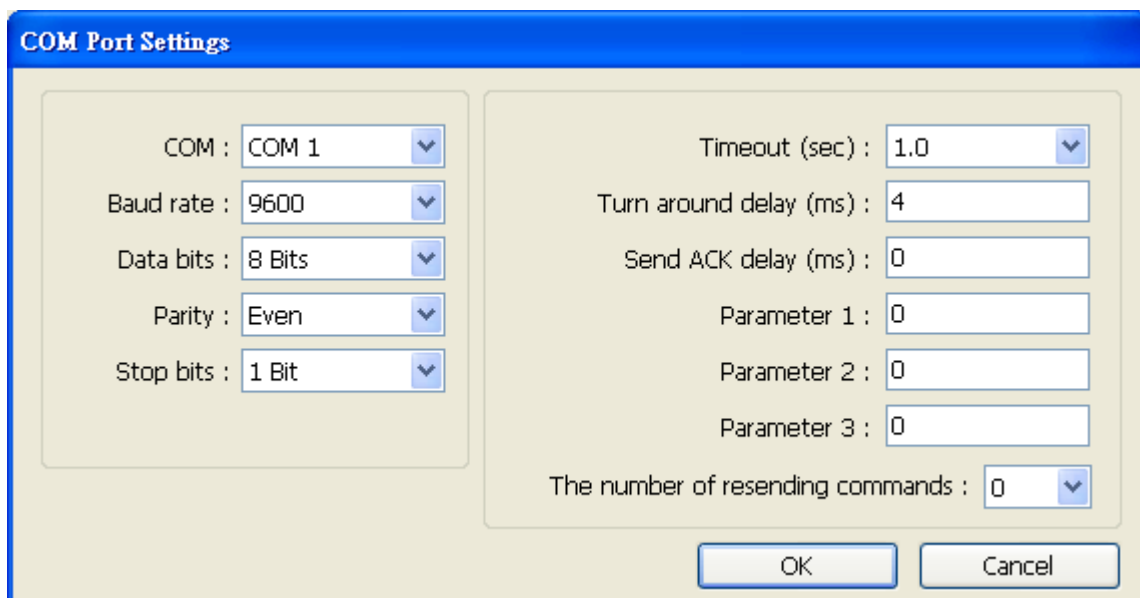



After completing all settings above, the communication is enabled.

Wiring Diagram:





The following represents the view of HMI & PLC.

MODBUS RTU CONTROLLER : RS232



eMT3000 series

COM1 RS232 9P D-Sub Female	COM3 RS232 9P D-Sub Female		RS232 9P D-Sub Female
2 RX	8 RX		TXD
3 TX	7 TX		RXD
5 GND	5 GND		GND
			RTS
			CTS
			circuit
			

MT6000/8000 series except MT6050i/MT8050i

COM1 RS232 9P D-Sub Female	COM2 RS232 9P D-Sub Female	COM3 RS232 9P D-Sub Male	RS232 9P D-Sub Female
2 RX	6 RX	8 RX	TXD
3 TX	4 TX	7 TX	RXD
5 GND	5 GND	5 GND	GND
			RTS
			CTS
			circuit
			



MT6050i/MT8050i

COM1 RS232 9P D-Sub Female			RS232 9P D-Sub Female
9 RX			TXD
6 TX			RXD
5 GND			GND
			RTS
			CTS
			circuit
			



The following represents the view of HMI & PLC.

MODBUS RTU CONTROLLER : RS485 4W



eMT3000 series

COM1 RS485 4W 9P D-Sub Male			RS485 4W 9P D-Sub Male
1 RX-			TX-
2 RX+			TX+
3 TX-			RX-
4 TX+			RX+
5 GND			GND
			

MT6000/8000 series except MT6050i/MT8050i

COM1 RS485 4W 9P D-Sub Male			RS485 4W 9P D-Sub Male
1 RX-			TX-
2 RX+			TX+
3 TX-			RX-
4 TX+			RX+
5 GND			GND
			



MT6050i/MT8050i

COM1 RS485 4W 9P D-Sub Female			RS485 4W 9P D-Sub Female
1 RX-			TX-
2 RX+			TX+
3 TX-			RX-
4 TX+			RX+
5 GND			GND
			



The following represents the view of HMI & PLC.

MODBUS RTU CONTROLLER : RS485 2W



eMT3000 series

COM1 RS485 2W 9P D-Sub Male	COM3 RS485 2W 9P D-Sub Male		RS485 2W 9P D-Sub Male
1 RX-	6 Data-		D-
2 RX+	9 Data+		D+
5 GND	5 GND		GND
			

MT6000/8000 series except MT6050i/MT8050i

COM1 RS485 2W 9P D-Sub Male	COM3 RS485 2W 9P D-Sub Male		RS485 2W 9P D-Sub Male
1 RX-	6 Data-		D-
2 RX+	9 Data+		D+
5 GND	5 GND		GND
			

MT6050i/MT8050i

COM1 RS485 2W 9P D-Sub Female	COM3 RS485 2W 9P D-Sub Female		RS485 2W 9P D-Sub Female
1 RX-	7 Data-		D-
2 RX+	8 Data+		D+
5 GND	5 GND		GND
			

Driver Version:

Version	Date	Description
V1.10	Aug/25/2010	
V1.20	Mar/2/2012	Allow modifying the Minimum address of 0x-1x Address Range.

MODBUS RTU (Adjustable)

Supported Series : MODBUS RTU CONTROLLER

Website : <http://www.modbus.org>

HMI Setting:

Parameters	Recommended	Options	Notes
PLC type	MODBUS RTU (Adjustable)		
PLC I/F	RS485	RS232/RS485	
Baud rate	9600	9600/19200/38400/57600/115200	
Data bits	8	7,8	
Parity	Even	Even, Odd, None	
Stop bits	1	1,2	
PLC sta. no.	1	0-255	

Online simulator	YES
Extend address mode	YES

PLC Setting:

Communication mode	Modbus RTU protocol
--------------------	---------------------

Device Address:

Bit/Word	Device type	Format	Range	Memo
B	0x	DDDDD	1 ~ 65535	Output bit
B	1x	DDDDD	1 ~ 65535	Input bit (read only)
B	3x_Bit	DDDDDdd	100 ~ 6553515	Input Register bit (read only)
B	4x_Bit	DDDDDdd	100 ~ 6553515	Output Register bit
B	0x_multi_coils	DDDDD	1 ~ 65535	Write multiple coils
W	3x	DDDDD	1 ~ 65535	Input Register (read only)
W	4x	DDDDD	1 ~ 65535	Output Register
W	5x	DDDDD	1 ~ 65535	4x double word swap
DW	5x (32-bit)	DDDDD	1 ~ 65535	4x double word
W	6x	DDDDD	1 ~ 65535	4x single word write

NOTE:

Address type “5x” is mapping to Hold Reg. The communication protocol of “5x” is almost the same as “4x” except that “5x” swaps double words.

If 4x contains the following information:

Address	1	2	3	4	5	6	...
Data in word	0x1	0x2	0x3	0x4	0x5	0x6	
Data	0x20001		0x40003		0x60005		

For 5x, it will be:

Address	1	2	3	4	5	6	...
Data in word	0x2	0x1	0x4	0x3	0x6	0x5	
Data	0x10002		0x30004		0x50006		

Modbus RTU function code:

0x	0x01	Read coil	0x05	Write single coil
0x_multi_coils	0x01	Read coil	0x0f	Write multiple coils
1x	0x02	Read discrete input		N/A for writing operation
3x	0x04	Read input register		N/A for writing operation
4x	0x03	Read holding register	0x10	Write multiple registers
5x	0x03	Read holding register	0x10	Write multiple registers

(Note: reverse word order in double words format)

3xbit is equivalent to 3x

4xbit is equivalent to 4x

6x	0x03	Read holding register	0x06	Write single register
----	------	-----------------------	------	-----------------------

(Note: 6x is limited to device of one word only)

Setting Instructions:

- Go to [System Parameter Settings]  , click [New] to add a new device - MODBUS RTU (Adjustable) , as shown below:

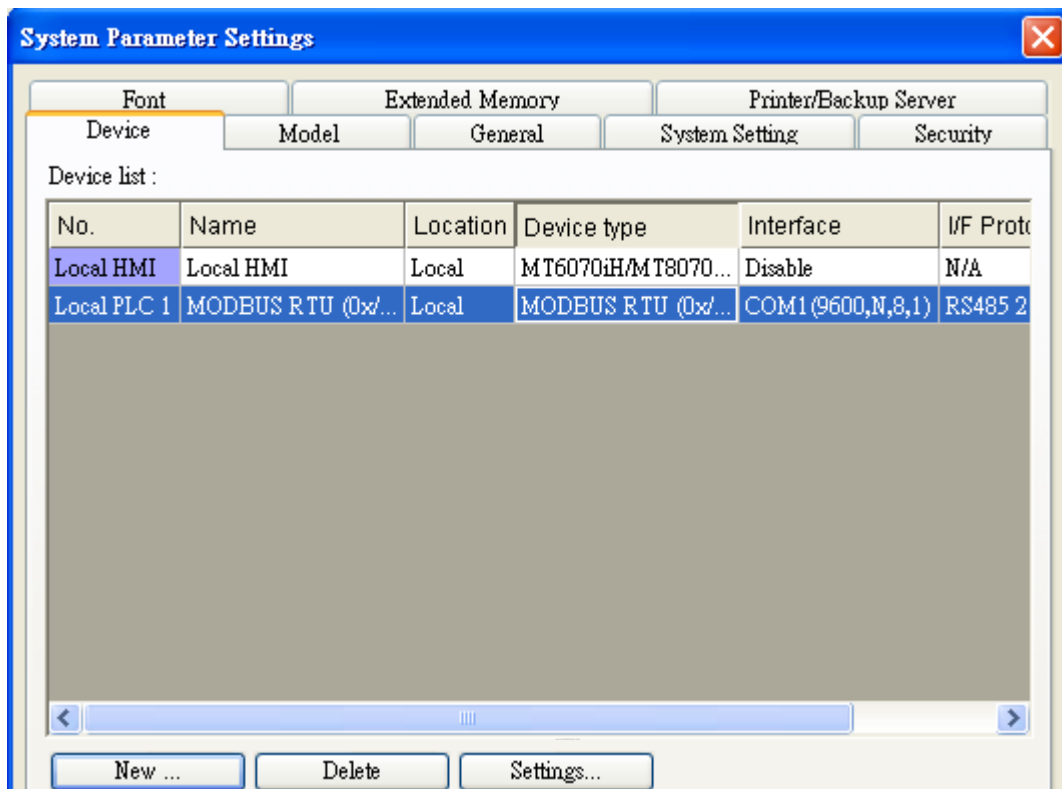

- After adding MODBUS RTU (Adjustable) driver, [Add Address Range Limit] button will be enabled as below. Users can set maximum read/write command size here.

- Max.read-command size (words): Pull down to select PLC reading range.

Max. read-command size (words) :

- Max.write-command size (words): Pull down to select PLC writing range.

Max. write-command size (words) :

Note:

MODBUS RTU (adjustable) usage

Users can decide the address range via setting value on Parameter 1. For example, when users set 5 to Parameter 1, the address range will be 5 ~ 65535.

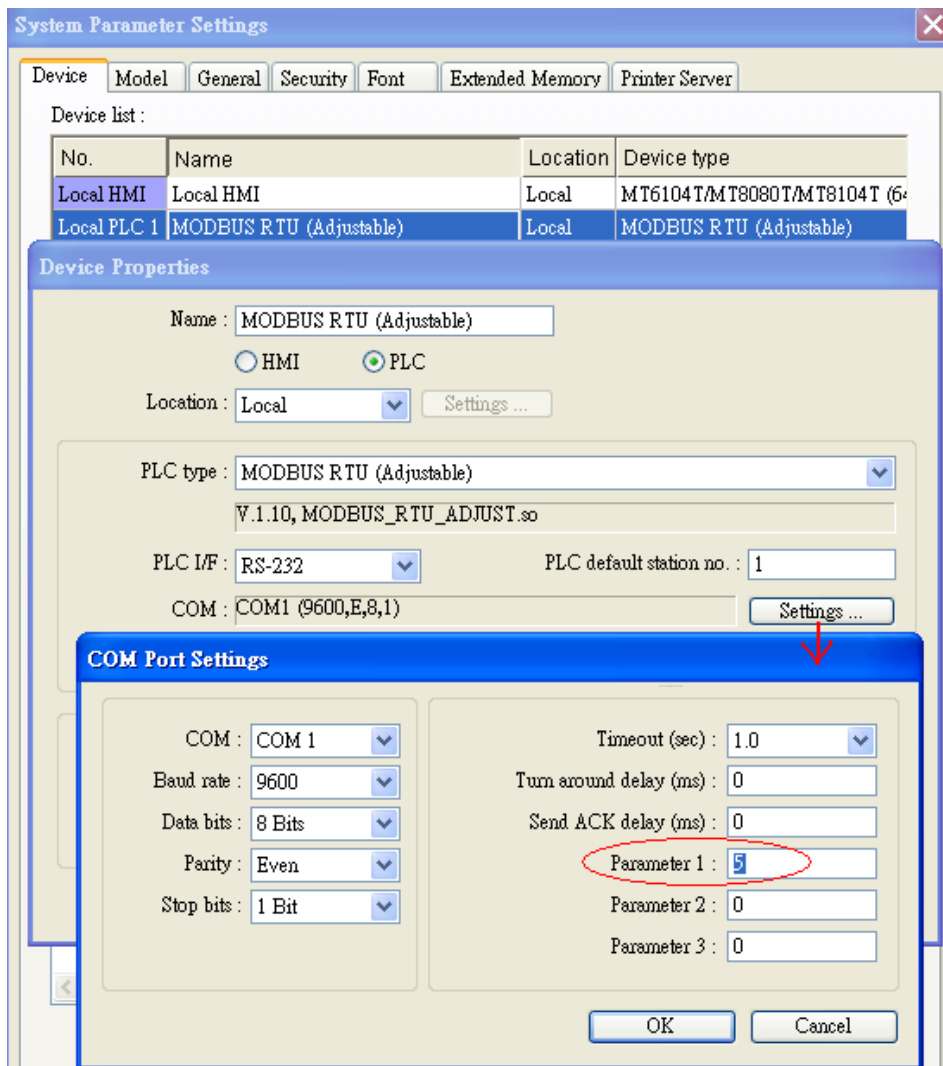



Wiring Diagram:





The following represents the view of HMI & PLC.

MODBUS RTU CONTROLLER : RS232



eMT3000 series

COM1 RS232 9P D-Sub Female	COM3 RS232 9P D-Sub Female		RS232 9P D-Sub Female
2 RX	8 RX		TXD
3 TX	7 TX		RXD
5 GND	5 GND		GND
			RTS
			CTS
			circuit
			

MT6000/8000 series except MT6050i/MT8050i

COM1 RS232 9P D-Sub Female	COM2 RS232 9P D-Sub Female	COM3 RS232 9P D-Sub Male	RS232 9P D-Sub Female
2 RX	6 RX	8 RX	TXD
3 TX	4 TX	7 TX	RXD
5 GND	5 GND	5 GND	GND
			RTS
			CTS
			circuit
			



MT6050i/MT8050i

COM1 RS232 9P D-Sub Female			RS232 9P D-Sub Female
9 RX			TXD
6 TX			RXD
5 GND			GND
			RTS
			CTS
			circuit
			



The following represents the view of HMI & PLC.

MODBUS RTU CONTROLLER : RS485 4W



eMT3000 series

COM1 RS485 4W 9P D-Sub Male			RS485 4W 9P D-Sub Male
1 RX-			TX-
2 RX+			TX+
3 TX-			RX-
4 TX+			RX+
5 GND			GND
			

MT6000/8000 series except MT6050i/MT8050i

COM1 RS485 4W 9P D-Sub Male			RS485 4W 9P D-Sub Male
1 RX-			TX-
2 RX+			TX+
3 TX-			RX-
4 TX+			RX+
5 GND			GND
			



MT6050i/MT8050i

COM1 RS485 4W 9P D-Sub Female			RS485 4W 9P D-Sub Female
1 RX-			TX-
2 RX+			TX+
3 TX-			RX-
4 TX+			RX+
5 GND			GND
			



The following represents the view of HMI & PLC.

MODBUS RTU CONTROLLER : RS485 2W



eMT3000 series

COM1 RS485 2W 9P D-Sub Male	COM3 RS485 2W 9P D-Sub Male		RS485 2W 9P D-Sub Male
1 RX-	6 Data-		D-
2 RX+	9 Data+		D+
5 GND	5 GND		GND
			

MT6000/8000 series except MT6050i/MT8050i

COM1 RS485 2W 9P D-Sub Male	COM3 RS485 2W 9P D-Sub Male		RS485 2W 9P D-Sub Male
1 RX-	6 Data-		D-
2 RX+	9 Data+		D+
5 GND	5 GND		GND
			

MT6050i/MT8050i

COM1 RS485 2W 9P D-Sub Female	COM3 RS485 2W 9P D-Sub Female		RS485 2W 9P D-Sub Female
1 RX-	7 Data-		D-
2 RX+	8 Data+		D+
5 GND	5 GND		GND
			

Driver Version:

Version	Date	Description
V1.40	Jun/14/2011	

MODBUS RTU (zero-based addressing)

Supported Series : MODBUS RTU CONTROLLER

Website : <http://www.modbus.org>

HMI Setting:

Parameters	Recommended	Options	Notes
PLC type	MODBUS RTU (zero-based addressing)		
PLC I/F	RS485	RS232/RS485	
Baud rate	9600	9600~115200	
Data bits	8	7,8	
Parity	Even	Even, Odd, None	
Stop bits	1	1,2	
PLC sta. no.	1	0-255	

Online simulator	YES	Broadcast command	YES
Extend address mode	YES		

PLC Setting:

Communication mode	Modbus RTU protocol
--------------------	---------------------

Device Address:

Bit/Word	Device type	Format	Range	Memo
B	0x	DDDDD	0 ~ 65535	Output bit
B	1x	DDDDD	0 ~ 65535	Input bit (read only)
B	3x_Bit	DDDDDdd	0 ~ 6553515	Input Register bit (read only)
B	4x_Bit	DDDDDdd	0 ~ 6553515	Output Register bit
B	0x_multi_coils	DDDDD	0 ~ 65535	Write multiple coils
W	3x	DDDDD	0 ~ 65535	Input Register (read only)
W	4x	DDDDD	0 ~ 65535	Output Register
DW	5x	DDDDD	0 ~ 65535	4x double word swap
W	6x	DDDDD	0 ~ 65535	4x single word write

NOTE:

Address type “5x” is mapping to Hold Reg. The communication protocol of 5x is almost the same as “4x” except that “5x” swaps double words.

If 4x contains the following information:

Address	1	2	3	4	5	6	...
Data in word	0x1	0x2	0x3	0x4	0x5	0x6	
Data	0x20001		0x40003		0x60005		

For 5x, it will be:

Address	1	2	3	4	5	6	...
Data in word	0x2	0x1	0x4	0x3	0x6	0x5	
Data	0x10002		0x30004		0x50006		

Modbus RTU function code:

0x	0x01	Read coil	0x05	write single coil
0x_multi_coils	0x01	Read coil	0x0f	write multiple coils
1x	0x02	Read discrete input	N/A	for write operation
3x	0x04	Read input register	N/A	for write operation
4x	0x03	Read holding register	0x10	write multiple registers
5x	0x03	Read holding register	0x10	write multiple registers

(Note: reverse word order in double word format)

3xbit is equivalent to 3x

4xbit is equivalent to 4x

6x	0x03	Read holding register	0x06	write single register
----	------	-----------------------	------	-----------------------



(Note: 6x is limited to device of one word only)

Wiring Diagram:





The following represents the view of HMI & PLC.

MODBUS RTU CONTROLLER : RS232



eMT3000 series

COM1 RS232 9P D-Sub Female	COM3 RS232 9P D-Sub Female		RS232 9P D-Sub Female
2 RX	8 RX		TXD
3 TX	7 TX		RXD
5 GND	5 GND		GND
			RTS
			CTS
			circuit
			

MT6000/8000 series except MT6050i/MT8050i

COM1 RS232 9P D-Sub Female	COM2 RS232 9P D-Sub Female	COM3 RS232 9P D-Sub Male	RS232 9P D-Sub Female
2 RX	6 RX	8 RX	TXD
3 TX	4 TX	7 TX	RXD
5 GND	5 GND	5 GND	GND
			RTS
			CTS
			circuit
			



MT6050i/MT8050i

COM1 RS232 9P D-Sub Female			RS232 9P D-Sub Female
9 RX			TXD
6 TX			RXD
5 GND			GND
			RTS
			CTS
			circuit
			



The following represents the view of HMI & PLC.

MODBUS RTU CONTROLLER : RS485 4W



eMT3000 series

COM1 RS485 4W 9P D-Sub Male			RS485 4W 9P D-Sub Male
1 RX-			TX-
2 RX+			TX+
3 TX-			RX-
4 TX+			RX+
5 GND			GND
			

MT6000/8000 series except MT6050i/MT8050i

COM1 RS485 4W 9P D-Sub Male			RS485 4W 9P D-Sub Male
1 RX-			TX-
2 RX+			TX+
3 TX-			RX-
4 TX+			RX+
5 GND			GND
			



MT6050i/MT8050i

COM1 RS485 4W 9P D-Sub Female			RS485 4W 9P D-Sub Female
1 RX-			TX-
2 RX+			TX+
3 TX-			RX-
4 TX+			RX+
5 GND			GND
			



The following represents the view of HMI & PLC.

MODBUS RTU CONTROLLER : RS485 2W



eMT3000 series

COM1 RS485 2W 9P D-Sub Male	COM3 RS485 2W 9P D-Sub Male		RS485 2W 9P D-Sub Male
1 RX-	6 Data-		D-
2 RX+	9 Data+		D+
5 GND	5 GND		GND
			

MT6000/8000 series except MT6050i/MT8050i

COM1 RS485 2W 9P D-Sub Male	COM3 RS485 2W 9P D-Sub Male		RS485 2W 9P D-Sub Male
1 RX-	6 Data-		D-
2 RX+	9 Data+		D+
5 GND	5 GND		GND
			

MT6050i/MT8050i

COM1 RS485 2W 9P D-Sub Female	COM3 RS485 2W 9P D-Sub Female		RS485 2W 9P D-Sub Female
1 RX-	7 Data-		D-
2 RX+	8 Data+		D+
5 GND	5 GND		GND
			

Driver Version:

Version	Date	Description
V1.30	Aug/26/2009	

MODBUS Server (COM/Ethernet)

HMI Setting:

Parameters	Recommended	Options	Notes
PLC type	MODBUS Server (COM/Ethernet)		
PLC I/F	RS232	RS232, RS485	
Baud rate	9600	9600~115200 Ethernet	Ethernet supports UDP or TCP/IP protocol
Data bits	8	8	
Parity	Even	Even, Odd,	
Stop bits	1	1	
PLC sta. no.	1	1-31	HMI Modbus Station No.
Port no.		502	

Online simulator	YES	Extend address mode	NO
Broadcast command	NO		

PLC Setting:

Communication mode	Modbus RTU protocol
--------------------	---------------------

Modbus Server UDP Protocol Setting:

MODBUS Server (Ethernet) supports UDP communication protocol. To use UDP mode, go to [System Parameter Settings] in editing software, in [Device list] click [New], for [PLC type] select "Modbus Server", [PLC I/F] set to [Ethernet], and select [Use UDP (User Datagram Protocol)] to finish setting.

Device Properties

Name : MODBUS Server

HMI PLC

Location : Local [Settings ...]

1. PLC type : MODBUS Server

2. V.1.00, MODBUS_SERVER.so

PLC I/F : Ethernet

IP : Port = 502 [Settings...]

3. Use UDP (User Datagram Protocol)

Station no. : 1

Use broadcast command

Interval of block pack (words) : 5

Max. read-command size (words) : 120

Max. write-command size (words) : 120

OK Cancel

Modbus Server Port No. can be changed by clicking [Settings].

Modbus Server Port No. can not be set identically to HMI Port No. When doing so, the warning message below will be shown requesting users to change setting.



Note:

A maximum of 64 Clients can be connected simultaneously.

Modbus Server Port No. can't be identical to HMI Port No.

Modbus Server TCP/IP Protocol Setting:

MODBUS Server (Ethernet) supports TCP/IP communication protocol. Go to [System Parameter Settings] in editing software, in [Device list] click [New], for [PLC type] select “Modbus Server”, [PLC I/F] set to [Ethernet] to finish setting.

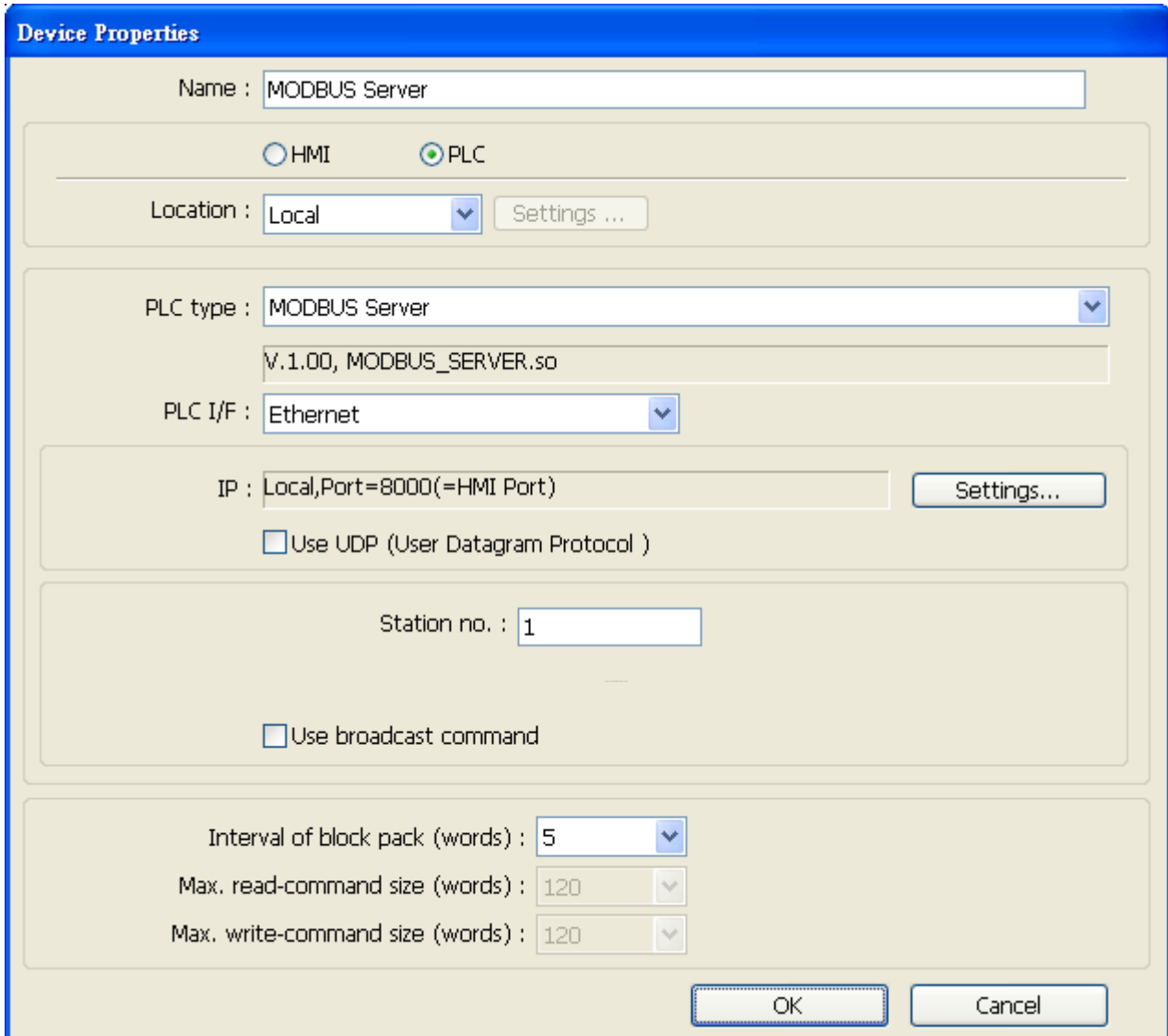

For Modbus Server TCP/IP, HMI Port No. is the same as Modbus Server Port No. To change Port No. go to [System Parameter Settings] / [Model], the default Port No. is “8000”, and it is allowed to change Modbus Server Port No. here.

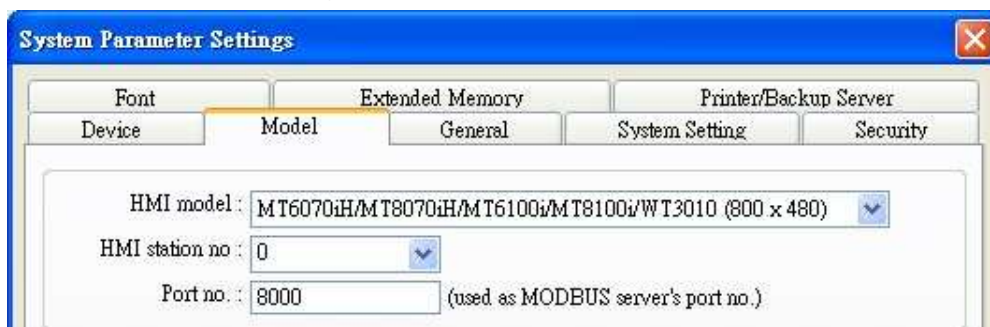

Device Address:

Bit/Word	Device type	Format	Range	Memo
B	LB	dddd	0 ~ 9998	Mapping to 0x/1x 1 ~ 9999
W	LW	dddd	0 ~ 9998	Mapping to 3x/4x 1 ~ 9999
W	RW	dddd	0 ~ 55536	Mapping to 3x/4x 10000 ~ 65536

LB0 = 0x0001, LB1 = 0x0002, LW0 = 3x0001, LW1 = 3x0002

Modbus RTU Server doesn't support function code 06(preset single register), please use function code 16(0x10, preset multiple registers).

Modbus Server Function Code:



0x	0x01	Read coil	0x05	write single coil
0x_multi_coils	0x01	Read coil	0x0f	write multiple coils
1x	0x02	Read discrete input	N/A	for write operation
3x	0x04	Read input register	N/A	for write operation
4x	0x03	Read holding register	0x10	write multiple registers

Wiring Diagram:





The following represents the view of HMI & PLC.

MODBUS SERVER : RS232



eMT3000 series

COM1 RS232 9P D-Sub Female	COM3 RS232 9P D-Sub Female		RS232 9P D-Sub Female
2 RX	8 RX		TXD
3 TX	7 TX		RXD
5 GND	5 GND		GND
			RTS
			CTS
			circuit
			

MT6000/8000 series except MT6050i/MT8050i

COM1 RS232 9P D-Sub Female	COM2 RS232 9P D-Sub Female	COM3 RS232 9P D-Sub Male	RS232 9P D-Sub Female
2 RX	6 RX	8 RX	TXD
3 TX	4 TX	7 TX	RXD
5 GND	5 GND	5 GND	GND
			RTS
			CTS
			circuit
			



MT6050i/MT8050i

COM1 RS232 9P D-Sub Female			RS232 9P D-Sub Female
9 RX			TXD
6 TX			RXD
5 GND			GND
			RTS
			CTS
			circuit
			



The following represents the view of HMI & PLC.

MODBUS SERVER : RS485 4W



eMT3000 series

COM1 RS485 4W 9P D-Sub Male			RS485 4W 9P D-Sub Male
1 RX-			TX-
2 RX+			TX+
3 TX-			RX-
4 TX+			RX+
5 GND			GND
			

MT6000/8000 series except MT6050i/MT8050i

COM1 RS485 4W 9P D-Sub Male			RS485 4W 9P D-Sub Male
1 RX-			TX-
2 RX+			TX+
3 TX-			RX-
4 TX+			RX+
5 GND			GND
			



MT6050i/MT8050i

COM1 RS485 4W 9P D-Sub Female			RS485 4W 9P D-Sub Female
1 RX-			TX-
2 RX+			TX+
3 TX-			RX-
4 TX+			RX+
5 GND			GND
			



The following represents the view of HMI & PLC.

MODBUS SERVER : RS485 2W



eMT3000 series

COM1 RS485 2W 9P D-Sub Male	COM3 RS485 2W 9P D-Sub Male		RS485 2W 9P D-Sub Male
1 RX-	6 Data-		D-
2 RX+	9 Data+		D+
5 GND	5 GND		GND
			

MT6000/8000 series except MT6050i/MT8050i

COM1 RS485 2W 9P D-Sub Male	COM3 RS485 2W 9P D-Sub Male		RS485 2W 9P D-Sub Male
1 RX-	6 Data-		D-
2 RX+	9 Data+		D+
5 GND	5 GND		GND
			

MT6050i/MT8050i

COM1 RS485 2W 9P D-Sub Female	COM3 RS485 2W 9P D-Sub Female		RS485 2W 9P D-Sub Female
1 RX-	7 Data-		D-
2 RX+	8 Data+		D+
5 GND	5 GND		GND
			

MODBUS SERVER : Ethernet

Direct connect (crossover cable):

HMI RJ45 Male	Wire Color	Wire Color	PLC RJ45 Male
1 TX+	White/Orange	White/Green	3 RX+
2 TX-	Orange	Green	6 RX-
3 RX+	White/Green	White/Orange	1 TX+
4 BD4+	Blue	Blue	4 BD4+
5 BD4-	White/Blue	White/Blue	5 BD4-
6 RX-	Green	Orange	2 TX-
7 BD3+	White/Brown	White/Brown	7 BD3+
8 BD3-	Brown	Brown	8 BD3-



Through a hub:

HMI RJ45 Male	Wire Color	Wire Color	PLC RJ45 Male
1 TX+	White/Orange	White/Orange	1 TX+
2 TX-	Orange	Orange	2 TX-
3 RX+	White/Green	White/Green	3 RX+
4 BD4+	Blue	Blue	4 BD4+
5 BD4-	White/Blue	White/Blue	5 BD4-
6 RX-	Green	Green	6 RX-
7 BD3+	White/Brown	White/Brown	7 BD3+
8 BD3-	Brown	Brown	8 BD3-



Note: Setting more than one Modbus Server in HMI Device List is of no effect.

Driver Version:

Version	Date	Description
V1.00	Dec/30/2008	Driver released

MODBUS TCP/IP

Supported Series: Modbus RTU TCP/IP device.

Website: <http://www.modbus.org>

HMI Setting:

Parameters	Recommended	Options	Notes
PLC type	MODBUS TCP/IP		
PLC I/F	Ethernet		
Port no.	502		
PLC sta. no.	1	0~255	

Device Address:

Bit/Word	Device type	Format	Range	Memo
B	0x	DDDDD	1 ~ 65535	Input bit
B	1x	DDDDD	1 ~ 65535	Output bit
B	3x_bit	DDDDDdd	100 ~ 6553515	Input Register bit(read only)
B	4x_bit	DDDDDdd	100 ~ 6553515	Output Register bit
B	6x_bit	DDDDDdd	100 ~ 6553515	Output Register bit
B	0x_multi_coils	DDDDD	1 ~ 65535	Write multiple coils
W	3x	DDDDD	1 ~ 65535	Input Register
W	4x	DDDDD	1 ~ 65535	Output Register
DW	5x	DDDDD	1 ~ 65535	4x double word swap
W	6x	DDDDD	1 ~ 65535	4x single word write
W	4x string central europe rev	DDDDD	1 ~ 65535	

Wiring Diagram:

Direct connect (crossover cable):

HMI RJ45 Male	Wire Color	Wire Color	PLC RJ45 Male
1 TX+	White/Orange	White/Green	3 RX+
2 TX-	Orange	Green	6 RX-
3 RX+	White/Green	White/Orange	1 TX+
4 BD4+	Blue	Blue	4 BD4+
5 BD4-	White/Blue	White/Blue	5 BD4-
6 RX-	Green	Orange	2 TX-
7 BD3+	White/Brown	White/Brown	7 BD3+
8 BD3-	Brown	Brown	8 BD3-



Through a hub:

HMI RJ45 Male	Wire Color	Wire Color	PLC RJ45 Male
1 TX+	White/Orange	White/Orange	1 TX+
2 TX-	Orange	Orange	2 TX-
3 RX+	White/Green	White/Green	3 RX+
4 BD4+	Blue	Blue	4 BD4+
5 BD4-	White/Blue	White/Blue	5 BD4-
6 RX-	Green	Green	6 RX-
7 BD3+	White/Brown	White/Brown	7 BD3+
8 BD3-	Brown	Brown	8 BD3-



Driver Version:

Version	Date	Description
V1.50	Aug/26/2009	

MODBUS TCP/IP (0x/1x Range Adjustable)

Supported Series : Modbus RTU TCP/IP device.

Website : <http://www.modbus.org>

HMI Setting:

Parameters	Recommended	Options	Notes
PLC type	MODBUS TCP/IP (0x/1x Range Adjustable)		
PLC I/F	Ethernet		
Port no.	502		
PLC sta. no.	1	0~255	

Online simulator	YES
Extend address mode	YES

Device Address:

Bit/Word	Device type	Format	Range	Memo
B	0x	DDDDD	1 ~ 65535	Output bit
B	1x	DDDDD	1 ~ 65535	Input bit (read only)
B	3x_Bit	DDDDDdd	100 ~ 6553515	Input Register bit (read only)
B	4x_Bit	DDDDDdd	100 ~ 6553515	Output Register bit
B	6x_Bit	DDDDDdd	100 ~ 6553515	Output Register bit
B	0x_multi_coils	DDDDD	1 ~ 65535	Write multiple coils
W	3x	DDDDD	1 ~ 65535	Input Register (read only)
W	4x	DDDDD	1 ~ 65535	Output Register
DW	5x	DDDDD	1 ~ 65535	4x double word swap
W	6x	DDDDD	1 ~ 65535	4x single word write
W	4x string central europe rev	DDDDD	1 ~ 65535	

NOTE:

Address type “5x” is mapping to Hold Reg. The communication protocol of “5x” is almost the same as “4x” except that “5x” swaps double words.

If 4x contains the following information:

Address	1	2	3	4	5	6	...
Data in word	0x1	0x2	0x3	0x4	0x5	0x6	
Data	0x20001		0x40003		0x60005		

For 5x, it will be:

Address	1	2	3	4	5	6	...
Data in word	0x2	0x1	0x4	0x3	0x6	0x5	
Data	0x10002		0x30004		0x50006		

Modbus RTU function code:

0x	0x01	Read coil	0x05	Write single coil
0x_multi_coils	0x01	Read coil	0x0f	Write multiple coils
1x	0x02	Read discrete input		N/A for writing operation
3x	0x04	Read input register		N/A for writing operation
4x	0x03	Read holding register	0x10	Write multiple registers
5x	0x03	Read holding register	0x10	Write multiple registers

(Note: reverse word order in double words format)

3xbit is equivalent to 3x

4xbit is equivalent to 4x

6x	0x03	Read holding register	0x06	Write single register
----	------	-----------------------	------	-----------------------

(Note: 6x is limited to device of one word only)

Setting Instructions:

- Go to [System Parameter Settings]  , click [New] to add a new device -MODBUS TCP/IP (0x/1x Range Adjustable) , as shown below:

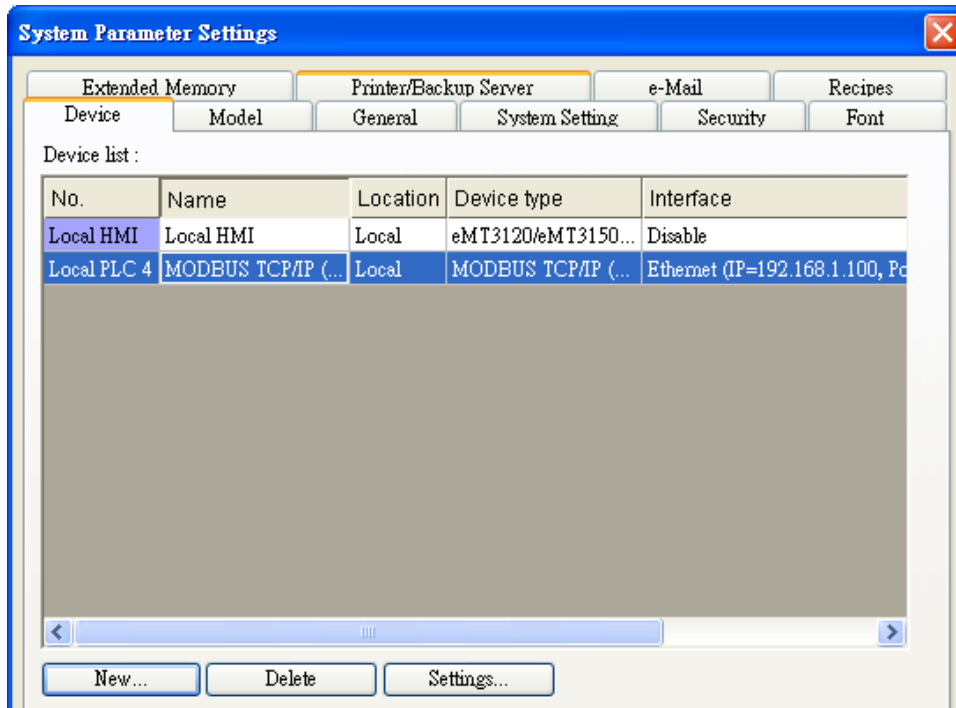

- Click [Add Address Range Limit] button, Users can define 0x and 1x address range in [0x 1x Address Range] dialog box, referring to bit range of the device used.

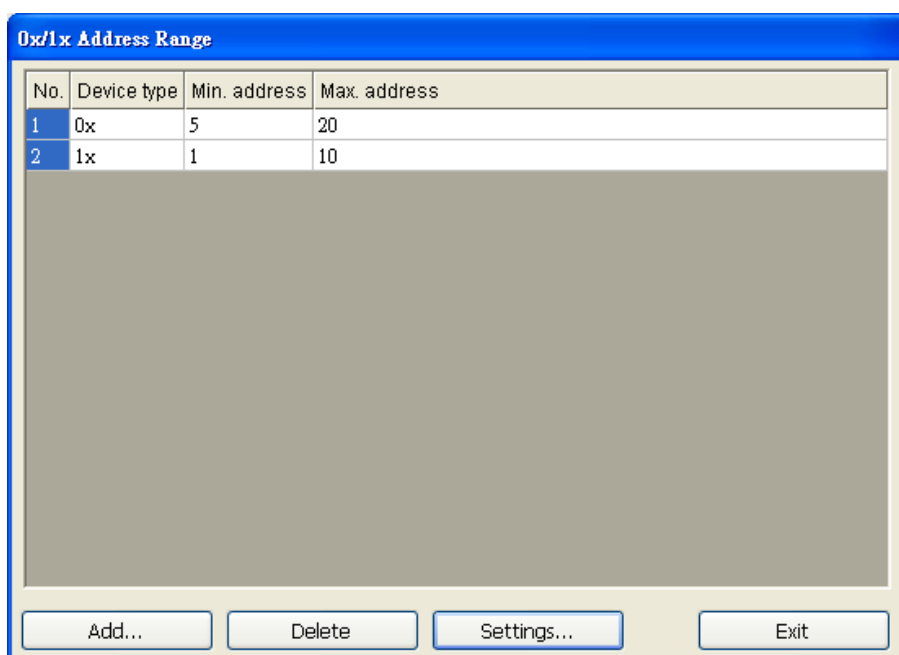

Add : Set [Station No.], [Device Type], [Max. Address] then click [OK] to finish adding as below:

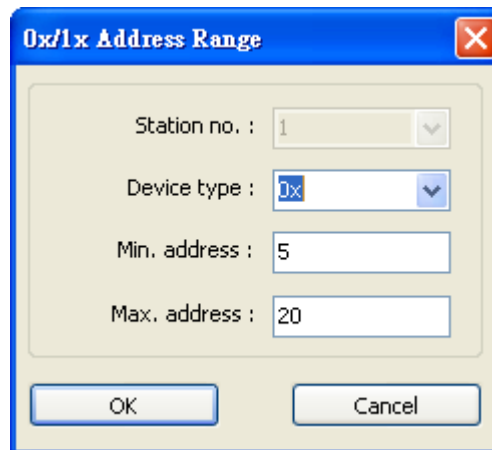

The screenshot shows a dialog box titled "0x/1x Address Range" with a close button (X) in the top right corner. The dialog contains four input fields and two buttons. The "Station no." field is a dropdown menu with "1" selected. The "Device type" field is a dropdown menu with "0x" selected. The "Min. address" field is a text box containing "5". The "Max. address" field is a text box containing "20". At the bottom, there are "OK" and "Cancel" buttons.

Delete : The selected items will be deleted.

Settings : Set [Station No.], [Device Type], [Max. Address] then click [OK] to finish adding as below:



The screenshot shows a dialog box titled "0x/1x Address Range" with a close button (X) in the top right corner. The dialog contains four input fields and two buttons. The "Station no." field is a dropdown menu with "1" selected. The "Device type" field is a dropdown menu with "1x" selected. The "Min. address" field is a text box containing "1". The "Max. address" field is a text box containing "10". At the bottom, there are "OK" and "Cancel" buttons.

Example :

Take 0x and 1x as example, the settings depend on bit range of different PLC types.

For 0x, [Device Type] **0x**, [Min. Address]**5**,[Max. Address] **20**.

For 1x, [Device Type] **0x**, [Min. Address]**1**,[Max. Address] **10**.

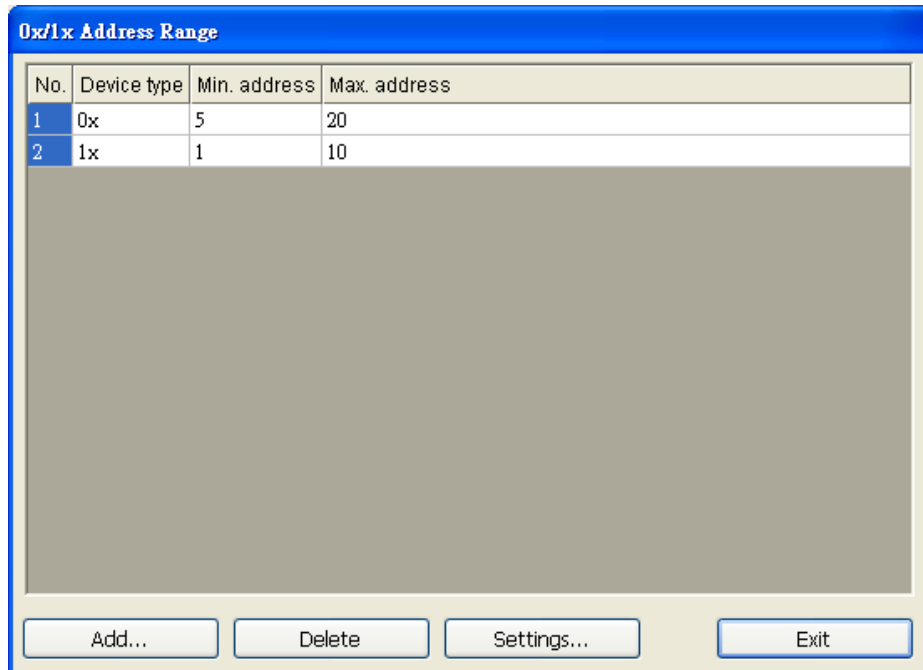

After completing all settings above, the communication is enabled.

Wiring Diagram:

Direct connect (crossover cable):

HMI RJ45 Male	Wire Color	Wire Color	PLC RJ45 Male
1 TX+	White/Orange	White/Green	3 RX+
2 TX-	Orange	Green	6 RX-
3 RX+	White/Green	White/Orange	1 TX+
4 BD4+	Blue	Blue	4 BD4+
5 BD4-	White/Blue	White/Blue	5 BD4-
6 RX-	Green	Orange	2 TX-
7 BD3+	White/Brown	White/Brown	7 BD3+
8 BD3-	Brown	Brown	8 BD3-



Through a hub:

HMI RJ45 Male	Wire Color	Wire Color	PLC RJ45 Male
1 TX+	White/Orange	White/Orange	1 TX+
2 TX-	Orange	Orange	2 TX-
3 RX+	White/Green	White/Green	3 RX+
4 BD4+	Blue	Blue	4 BD4+
5 BD4-	White/Blue	White/Blue	5 BD4-
6 RX-	Green	Green	6 RX-
7 BD3+	White/Brown	White/Brown	7 BD3+
8 BD3-	Brown	Brown	8 BD3-



Driver Version:

Version	Date	Description
V1.00	NOV/2/2011	Driver released.
V1.10	MAR/14/2012	Allow modifying the Minimum address of 0x-1x Address Range.

MODBUS TCP/IP (zero-based addressing)

Supported Series : Modbus RTU TCP/IP device.

Website: <http://www.modbus.org>

HMI Setting:

Parameters	Recommended	Options	Notes
PLC type	MODBUS TCP/IP (zero-based addressing)		
PLC I/F	Ethernet		
Port no.	502		
PLC sta. no.	1	0~255	

Device Address:

Bit/Word	Device type	Format	Range	Memo
B	0x	DDDDD	0 ~ 65535	Input bit
B	1x	DDDDD	0 ~ 65535	Output bit
B	3x_Bit	DDDDDdd	0 ~ 6553515	Input Register bit (read only)
B	4x_Bit	DDDDDdd	0 ~ 6553515	Output Register bit
B	6x_Bit	DDDDDdd	0 ~ 6553515	Output Register bit
B	0x_multi_coils	DDDDD	0 ~ 65535	Write multiple coils
W	3x	DDDDD	0 ~ 65535	Input Register
W	4x	DDDDD	0 ~ 65535	Output Register
DW	5x	DDDDD	0 ~ 65535	4x double word swap
W	6x	DDDDD	0 ~ 65535	4x single word write

Wiring Diagram:

Direct connect (crossover cable):

HMI RJ45 Male	Wire Color	Wire Color	PLC RJ45 Male
1 TX+	White/Orange	White/Green	3 RX+
2 TX-	Orange	Green	6 RX-
3 RX+	White/Green	White/Orange	1 TX+
4 BD4+	Blue	Blue	4 BD4+
5 BD4-	White/Blue	White/Blue	5 BD4-
6 RX-	Green	Orange	2 TX-
7 BD3+	White/Brown	White/Brown	7 BD3+
8 BD3-	Brown	Brown	8 BD3-



Through a hub:

HMI RJ45 Male	Wire Color	Wire Color	PLC RJ45 Male
1 TX+	White/Orange	White/Orange	1 TX+
2 TX-	Orange	Orange	2 TX-
3 RX+	White/Green	White/Green	3 RX+
4 BD4+	Blue	Blue	4 BD4+
5 BD4-	White/Blue	White/Blue	5 BD4-
6 RX-	Green	Green	6 RX-
7 BD3+	White/Brown	White/Brown	7 BD3+
8 BD3-	Brown	Brown	8 BD3-



Driver Version:

Version	Date	Description
V1.40	Aug/27/2009	

MODBUS TCP/IP 32Bit

Supported Series: Modbus RTU TCP/IP device.

Website: <http://www.modbus.org>

HMI Setting:

Parameters	Recommended	Options	Notes
PLC type	MODBUS TCP/IP 32Bit		
PLC I/F	Ethernet		
Port no.	502		
PLC sta. no.	1	0~255	

Device Address:

Bit/Word	Device type	Format	Range	Memo
B	0x	DDDDD	1 ~ 65535	Input bit
B	1x	DDDDD	1 ~ 65535	Output bit
B	3x_Bit	DDDDDdd	100 ~ 6553515	Input Register bit (read only)
B	4x_Bit	DDDDDdd	100 ~ 6553515	Output Register bit
B	6x_Bit	DDDDDdd	100 ~ 6553515	Output Register bit
B	0x_multi_coils	DDDDD	1 ~ 65535	Write multiple coils
W	3x	DDDDD	1 ~ 65535	Input Register
W	4x	DDDDD	1 ~ 65535	Output Register
DW	5x	DDDDD	1 ~ 65535	4x double word swap
W	6x	DDDDD	1 ~ 65535	4x single word write
W	4x_32Bit*	DDDDD	1 ~ 65535	

4x_32Bit will only read / write 2 words for each package, for continuous addresses, it will be divided into several packages.

Wiring Diagram:

Direct connect (crossover cable):

HMI RJ45 Male	Wire Color	Wire Color	PLC RJ45 Male
1 TX+	White/Orange	White/Green	3 RX+
2 TX-	Orange	Green	6 RX-
3 RX+	White/Green	White/Orange	1 TX+
4 BD4+	Blue	Blue	4 BD4+
5 BD4-	White/Blue	White/Blue	5 BD4-
6 RX-	Green	Orange	2 TX-
7 BD3+	White/Brown	White/Brown	7 BD3+
8 BD3-	Brown	Brown	8 BD3-



Through a hub:

HMI RJ45 Male	Wire Color	Wire Color	PLC RJ45 Male
1 TX+	White/Orange	White/Orange	1 TX+
2 TX-	Orange	Orange	2 TX-
3 RX+	White/Green	White/Green	3 RX+
4 BD4+	Blue	Blue	4 BD4+
5 BD4-	White/Blue	White/Blue	5 BD4-
6 RX-	Green	Green	6 RX-
7 BD3+	White/Brown	White/Brown	7 BD3+
8 BD3-	Brown	Brown	8 BD3-



Driver Version:

Version	Date	Description
V1.10	Aug/27/2009	Driver released.

Moeller XC-CPU101

Supported Series: MOELLER XC100/200 series

Website: <http://www.moeller.net>

HMI Setting:

Parameters	Recommended	Options	Notes
PLC type	Moeller XC-CPU101		
PLC I/F	RS232		
Baud rate	38400	4800 ~ 57600	
Data bits	8		
Parity	None		
Stop bits	1		
PLC sta. no.	1		



Device Address:

Bit/Word	Device type	Format	Range	Note
B	QX	DDo	0 ~ 157	
B	IX	DDo	0 ~ 157	
W	MW	DDDD	0 ~ 4095	
W	QW	DD	0 ~ 15	
W	IW	DD	0 ~ 15	





Wiring Diagram:

The following represents the view of HMI & PLC.



eMT3000 series

COM1 RS232 9P D-Sub Female	COM3 RS232 9P D-Sub Female		RS232 8P RJ45 Male
2 RX	8 RX		5 TD
3 TX	7 TX		8 RD
5 GND	5 GND		4 GND
			

MT6000/8000 series except MT6050i/MT8050i

COM1 RS232 9P D-Sub Female	COM2 RS232 9P D-Sub Female	COM3 RS232 9P D-Sub Male	RS232 8P RJ45 Male
2 RX	6 RX	8 RX	5 TD
3 TX	4 TX	7 TX	8 RD
5 GND	5 GND	5 GND	4 GND
			

MT6050i/MT8050i

COM1 RS232 9P D-Sub Female			RS232 8P RJ45 Male
9 RX			5 TD
6 TX			8 RD
5 GND			4 GND
			

Driver Version:

Version	Date	Description
1.00	Apr/01/2010	Driver released.

OHJX

Website: <http://www.ohjx.com/>

HMI Setting:

Parameters	Recommended	Options	Notes
PLC type	OHJX		
PLC I/F	RS-232		
Baud rate	9600	9600,19200	
Data bits	8		
Parity	Odd		
Stop bits	1		
PLC sta. no.	1		

Device Address:



Bit/Word	Device type	Format	Range	Memo
B	R100	Dh	0 ~ 1f	
B	R101	Dh	0 ~ 1f	
B	R102	Dh	0 ~ 1f	
B	R103	Dh	0 ~ 1f	
B	R104	Dh	0 ~ 1f	
B	R105	Dh	0 ~ 1f	
B	R106	Dh	0 ~ 1f	
B	R107	Dh	0 ~ 1f	
B	R108	Dh	0 ~ 1f	
B	R109	Dh	0 ~ 1f	
B	R110	Dh	0 ~ 1f	
B	R210	Dh	0 ~ 1f	
B	R310	Dh	0 ~ 1f	
W	SV	DDDD	0 ~ 9999	
W	EV	DDDDD	0 ~ 65535	
W	DT	DDDDD	0 ~ 9999	
W	LD	DDDD	0 ~ 8447	
W	WX	DDDD	0 ~ 9999	

Bit/Word	Device type	Format	Range	Memo
W	WY	DDDD	0 ~ 9999	
W	WR	DDDD	0 ~ 9999	
W	WL	DDDD	0 ~ 9999	
W	FL	DDDDD	0 ~ 99999	





Wiring Diagram:

The following represents the view of HMI & PLC.



eMT3000 series

COM1 RS232 9P D-Sub Female	COM3 RS232 9P D-Sub Female		4P Mini-DIN Male
2 RX	8 RX		3 TX
3 TX	7 TX		2 RX
5 GND	5 GND		1 GND
			4 GND
			

MT6000/8000 series except MT6050i/MT8050i

COM1 RS232 9P D-Sub Female	COM2 RS232 9P D-Sub Female	COM3 RS232 9P D-Sub Male	4P Mini-DIN Male
2 RX	6 RX	8 RX	3 TX
3 TX	4 TX	7 TX	2 RX
5 GND	5 GND	5 GND	1 GND
			4 GND
			

MT6050i/MT8050i

COM1 RS232 9P D-Sub Female			4P Mini-DIN Male
9 RX			3 TX
6 TX			2 RX
5 GND			1 GND
			4 GND
			

Driver Version:

Version	Date	Description
V1.00	Nov/22/2011	Driver released.

OMRON C/CQM1 Series

Supported Series: OMRON C, CPM, CPL, CQM Series (Host Link Protocol)

Website: <http://oeiweb.omron.com/oei/Products-PLC.htm>

HMI Setting:

Parameters	Recommended	Options	Notes
PLC type	OMRON C/CQM1 Series		
PLC I/F	RS232	RS232, RS422, RS485	
Baud rate	9600	9600, 19200	
Data bits	7	7 or 8	
Parity	Even	Even, Odd, None	
Stop bits	2	1 or 2	
PLC sta. no.	0	0-31	Host Link Station No.

Online simulator	YES	Broadcast command	YES
Extend address mode	YES		

PLC Setting:

Communication mode	Host Link Protocol
--------------------	--------------------

Device Address:

Bit/Word	Device type	Format	Range	Memo
B	IR	DDDDdd	0 ~ 409515	I/O and Internal Relay
B	HR	DDDDdd	0 ~ 409515	Hold Relay
B	LR	DDDDdd	0 ~ 409515	Link Relay
B	IR (Force Set/Reset)	DDDDdd	0 ~ 409515	
B	HR (Force Set/Reset)	DDDDdd	0 ~ 409515	
B	LR (Force Set/Reset)	DDDDdd	0 ~ 409515	
B	AR	DDDDdd	0 ~ 409515	Auxiliary Relay
W	AR_W	DDDD	0 ~ 4095	
W	IR_W	DDDD	0 ~ 4095	
W	HR_W	DDDD	0 ~ 4095	
W	LR_W	DDDD	0 ~ 4095	
W	TC	DDD	0 ~ 255	
W	DM	DDDD	0 ~ 9999	Data Register

Wiring Diagram:

The following represents the view of HMI & PLC.



CPU Port (CPM2A,CQM1/1H,C200H/HS/ALPHA series)

Communication Module:





CPM1-CIF01 adapter (for CPM1/CPM1A/CPM2A series, CQM1/CQM1H series)

CPM1H-SCB41 communication module (for CQM1H-CPU51/61)



eMT3000 series

COM1 RS232 9P D-Sub Female	COM3 RS232 9P D-Sub Female		RS232 9P D-Sub Male
2 RX	8 RX		2 SD
3 TX	7 TX		3 RD
5 GND	5 GND		9 GND
			4 RS
			5 CS
			circuit
			

MT6000/8000 series except MT6050i/MT8050i

COM1 RS232 9P D-Sub Female	COM2 RS232 9P D-Sub Female	COM3 RS232 9P D-Sub Male	RS232 9P D-Sub Male
2 RX	6 RX	8 RX	2 SD
3 TX	4 TX	7 TX	3 RD
5 GND	5 GND	5 GND	9 GND
			4 RS
			5 CS
			circuit
			

MT6050i/MT8050i



COM1 RS232 9P D-Sub Female			RS232 9P D-Sub Male
9 RX			2 SD
6 TX			3 RD
5 GND			9 GND
			4 RS
			5 CS
			circuit
			

The following represents the view of HMI & PLC.





C200h-LK201,3G2A6-LK201 communication module

C200HW-COM02/03/04/05/06 communication module



eMT3000 series

COM1 RS232 9P D-Sub Female	COM3 RS232 9P D-Sub Female		RS232 9P D-Sub Male
2 RX	8 RX		2 SD
3 TX	7 TX		3 RD
5 GND	5 GND		7 GND
			4 RS
			5 CS
			circuit
			

MT6000/8000 series except MT6050i/MT8050i

COM1 RS232 9P D-Sub Female	COM2 RS232 9P D-Sub Female	COM3 RS232 9P D-Sub Male	RS232 9P D-Sub Male
2 RX	6 RX	8 RX	2 SD
3 TX	4 TX	7 TX	3 RD
5 GND	5 GND	5 GND	7 GND
			4 RS
			5 CS
			circuit
			

MT6050i/MT8050i

COM1 RS232 9P D-Sub Female			RS232 9P D-Sub Male
9 RX			2 SD
6 TX			3 RD
5 GND			7 GND
			4 RS
			5 CS
			circuit
			

Driver Version:

Version	Date	Description
V1.80	Apr/14/2010	

OMRON CJ/CS/CP

Supported Series: OMRON CP1E, CP1L, CP1H, CJ1M, CJ2M, CJ1H, CJM1G, CS1H and CS1G. (Host Link Protocol FINS command), this driver supports Extend Addressing Mode.

Website: <http://oeiweb.omron.com/oei/Products-PLC.htm>

HMI Setting:

Parameters	Recommended	Options	Notes
PLC type	OMRON CJ/CS/CP		
PLC I/F	RS232	RS232, RS422, RS485	
Baud rate	9600	9600~115200	
Data bits	7	7 or 8	
Parity	Even	Even, Odd, None	
Stop bits	2	1 or 2	
PLC sta. no.	0	0-31	Host Link Station No.

Online simulator	YES	Extend address mode	YES
Broadcast command	NO		

PLC Setting:

Communication mode	Host Link Protocol
--------------------	--------------------

Device Address:

Bit/Word	Device type	Format	Range	Memo
B	CIO_Bit	DDDDdd	0 ~ 3276715	Channel I/O (CIO)
B	W_Bit	DDDDdd	0 ~ 3276715	Work Area (WR)
B	H_Bit	DDDDdd	0 ~ 3276715	Holding Area (HR)
B	D_Bit	DDDDdd	0 ~ 3276715	Data Memory (DM)
B	A_Bit	DDDDdd	0 ~ 3276715	Auxiliary Relay (AR)
B	T_Bit	DDDDdd	0 ~ 3276715	Timer (TIM)
B	C_Bit	DDDDdd	0 ~ 3276715	Counter (CNT)
B	C_flag	DDDD	0 ~ 4095	
B	T_flag	DDDD	0 ~ 4095	
B	LR_Bit	DDDdd	0 ~ 19915	



Bit/Word	Device type	Format	Range	Memo
W	T	DDDDD	0 ~ 32767	Timer (TIM)
W	H	DDDDD	0 ~ 32767	Holding Area (HR)
W	D	DDDDD	0 ~ 32767	Data Memory (DM)
W	A	DDDDD	0 ~ 32767	Auxiliary Relay (AR)
W	W	DDDDD	0 ~ 32767	Work Area (WR)
W	C	DDDDD	0 ~ 32767	Counter (CNT)
W	CIO	DDDDD	0 ~ 32767	Channel I/O (CIO)
W	EM0 ~ EMC	DDDDD	0 ~ 32767	Extend Memory
W	LR	DDD	0 ~ 199	

Wiring Diagram:



The following represents the view of HMI & PLC.

9P D-Sub to 9P D-Sub:

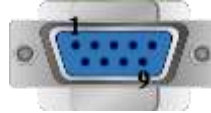

eMT3000 series

COM1 RS232 9P D-Sub Female	COM3 RS232 9P D-Sub Female		RS232 9P D-Sub Male
2 RX	8 RX		2 SD
3 TX	7 TX		3 RD
5 GND	5 GND		9 GND
			4 RS
			5 CS
			circuit
			

MT6000/8000 series except MT6050i/MT8050i

COM1 RS232 9P D-Sub Female	COM2 RS232 9P D-Sub Female	COM3 RS232 9P D-Sub Male	RS232 9P D-Sub Male
2 RX	6 RX	8 RX	2 SD
3 TX	4 TX	7 TX	3 RD
5 GND	5 GND	5 GND	9 GND
			4 RS
			5 CS
			circuit
			



MT6050i/MT8050i

COM1 RS232 9P D-Sub Female			RS232 9P D-Sub Male
9 RX			2 SD
6 TX			3 RD
5 GND			9 GND
			4 RS
			5 CS
			circuit
			



The following represents the view of HMI & PLC.

CP1H/CP1L CP1W-CIF11 RS485 4W : 9P D-Sub to Terminals:



eMT3000 series

COM1 RS485 4W 9P D-Sub Male			CP1W-CIF11 RS485 4W Terminal
1 RX-			SDA
2 RX+			SDB
3 TX-			RDA
4 TX+			RDB
5 GND			FG
			

MT6000/8000 series except MT6050i/MT8050i

COM1 RS485 4W 9P D-Sub Male			CP1W-CIF11 RS485 4W Terminal
1 RX-			SDA
2 RX+			SDB
3 TX-			RDA
4 TX+			RDB
5 GND			FG
			

MT6050i/MT8050i

COM1 RS485 4W 9P D-Sub Female			CP1W-CIF11 RS485 4W Terminal
1 RX-			SDA
2 RX+			SDB
3 TX-			RDA
4 TX+			RDB
5 GND			FG
			

CP1W-CIF11: SW1 ON, others OFF.

Driver Version:

Version	Date	Description
V1.90	Feb/01/2011	Added registers: LR, LR_Bit

OMRON CJ1/CS1 (Ethernet)

Supported Series: OMRON CJ Series, CS Series, CP Series +Ethernet Module. (Ethernet FINS)

Website: <http://oeiweb.omron.com/oei/Products-PLC.htm>

*On initialization, switch from RUN MODE to MONITOR MODE.

HMI Setting:

Parameters	Recommended	Options	Notes
PLC type	OMRON CJ1/CS1 (Ethernet)		
PLC I/F	Ethernet		
Port no.	9600		
PLC sta. no.	0		

PLC Setting:

Communication mode	FINS Ethernet protocol
--------------------	------------------------

Device Address:

Bit/Word	Device type	Format	Range	Memo
B	CIO_Bit	DDDDDDdd	0 ~ 3276715	Channel I/O (CIO)
B	W_Bit	DDDDDDdd	0 ~ 3276715	Work Area (WR)
B	H_Bit	DDDDDDdd	0 ~ 3276715	Holding Area (HR)
B	A_Bit	DDDDDDdd	0 ~ 3276715	Auxiliary Relay (AR) (Read only)
B	D_Bit	DDDDDDdd	0 ~ 3276715	Data Memory (DM)
B	T_Bit	DDDDDDdd	0 ~ 3276715	Timer (TIM)
B	C_Bit	DDDDDDdd	0 ~ 3276715	Counter (CNT)
B	C_Flag	DDDD	0 ~ 4095	
B	T_Flag	DDDD	0 ~ 4095	
W	CIO	DDDDD	0 ~ 32767	Channel I/O (CIO)
W	W	DDDDD	0 ~ 32767	Work Area (WR)
W	H	DDDDD	0 ~ 32767	Holding Area (HR)
W	A	DDDDD	0 ~ 32767	Auxiliary Relay (AR) (Read only)
W	C	DDDDD	0 ~ 32767	Counter (CNT)
W	T	DDDDD	0 ~ 32767	Timer (TIM)
W	D	DDDDD	0 ~ 32767	Data Memory (DM)
W	EM0 ~ EMC	DDDDD	0 ~ 32767	Extend Memory

Wiring Diagram:

Direct connect (crossover cable):

HMI RJ45 Male	Wire Color	Wire Color	PLC RJ45 Male
1 TX+	White/Orange	White/Green	3 RX+
2 TX-	Orange	Green	6 RX-
3 RX+	White/Green	White/Orange	1 TX+
4 BD4+	Blue	Blue	4 BD4+
5 BD4-	White/Blue	White/Blue	5 BD4-
6 RX-	Green	Orange	2 TX-
7 BD3+	White/Brown	White/Brown	7 BD3+
8 BD3-	Brown	Brown	8 BD3-



Through a hub:

HMI RJ45 Male	Wire Color	Wire Color	PLC RJ45 Male
1 TX+	White/Orange	White/Orange	1 TX+
2 TX-	Orange	Orange	2 TX-
3 RX+	White/Green	White/Green	3 RX+
4 BD4+	Blue	Blue	4 BD4+
5 BD4-	White/Blue	White/Blue	5 BD4-
6 RX-	Green	Green	6 RX-
7 BD3+	White/Brown	White/Brown	7 BD3+
8 BD3-	Brown	Brown	8 BD3-



Driver Version:

Version	Date	Description
V1.50	Jun/30/2010	

OMRON E5CN/E5EZ/E5ZN

Supported Series: OMRON E5CN series temperature controller with communication options. E5EN/CN/GN/EZ/ZN series.

Website: <http://oeiweb.omron.com>

HMI Setting:

Parameters	Recommended	Options	Notes
PLC type	OMRON E5CN		
PLC I/F	RS485 2W		
Baud rate	9600	9600/19200/38400/ 57600/115200	
Data bits	7	7,8	
Parity	Even	Even, Odd, None	
Stop bits	2	1,2	
PLC sta. no.	0	0-99	

Online simulator	YES	Broadcast command	YES
Extend address mode	YES		

Device Address:

Bit/Word	Device type	Format	Range	Memo
B	Status_CH1	DD	0 ~ 31	Page40
B	Status_CH2	DD	0 ~ 31	
DW	C0	HHHH	0 ~ 270f	Read only (Hex) Page34
DW	C1	HHHH	0 ~ 270f	Read/Write (Hex) Page35
DW	C2	HHHH	0 ~ 270f	Read/Write (Hex) Page35
DW	C3	HHHH	0 ~ 270f	Read/Write (Hex) Page36
W	Code00_00	H	0	Communications writing OFF (disabled)
W	Code00_01	H	0	Communications writing ON(enabled)
W	Code01_00	H	0	Run
W	Code01_01	H	0	Stop
W	Code02_00	H	0	Multi-SP Set point 0
W	Code02_01	H	0	Multi-SP Set point 1
W	Code02_02	H	0	Multi-SP Set point 2



Bit/Word	Device type	Format	Range	Memo
W	Code02_03	H	0	Multi-SP Set point 3
W	Code03_00	H	0	AT cancel
W	Code03_01	H	0	AT execute
W	Code04_00	H	0	Write mode (Backup)
W	Code04_01	H	0	Write mode (Ram)
W	Code05_00	H	0	Save RAM data
W	Code06_00	H	0	Software reset
W	Code07_00	H	0	Move to setup area 1
W	Code08_00	H	0	Move to protect level
W	Code01_10	H	0	
W	Code01_11	H	0	
W	Code01_F0	H	0	
W	Code01_F1	H	0	
W	Code02_10	H	0	
W	Code02_11	H	0	
W	Code02_F0	H	0	
W	Code02_F1	H	0	
W	Code03_10	H	0	
W	Code03_11	H	0	
W	Code03_F0	H	0	
W	Code03_F1	H	0	
W	Code09_00	H	0	
W	Code09_01	H	0	
W	Code09_10	H	0	
W	Code09_11	H	0	
W	Code09_F0	H	0	
W	Code09_F1	H	0	
W	Code0A_00	H	0	
W	Code0B_00	H	0	
W	Code0C_00	H	0	
W	Code0C_01	H	0	
W	Code0C_02	H	0	
W	Code0C_0F	H	0	
W	Code0C_10	H	0	
W	Code0C_11	H	0	
W	Code0C_12	H	0	
W	Code0C_1F	H	0	
W	Code0C_F0	H	0	
W	Code0C_F1	H	0	
W	Code0C_F2	H	0	

Bit/Word	Device type	Format	Range	Memo
W	Code0C_FF	H	0	



Wiring Diagram:

The following represents the view of HMI & PLC.



eMT3000 series

COM1 RS485 2W 9P D-Sub Male	COM3 RS485 2W 9P D-Sub Male		OMRON E5CN Terminal
1 RX-	6 Data-		12 B
2 RX+	9 Data+		11 A
5 GND	5 GND		GND
			

MT6000/8000 series except MT6050i/MT8050i

COM1 RS485 2W 9P D-Sub Male	COM3 RS485 2W 9P D-Sub Male		OMRON E5CN Terminal
1 RX-	6 Data-		12 B
2 RX+	9 Data+		11 A
5 GND	5 GND		GND
			

MT6050i/MT8050i

COM1 RS485 2W 9P D-Sub Female	COM3 RS485 2W 9P D-Sub Female		OMRON E5CN Terminal
1 RX-	7 Data-		12 B
2 RX+	8 Data+		11 A
5 GND	5 GND		GND
			

Note:

For communication with OMRON E5EZ, please set communication settings to 9600, E, 7, 2, station no. 1.

Driver Version:

Version	Date	Description
V1.21	Dec/21/2010	

OMRON FINS (Ethernet)

Supported Series: Non OMRON PLC . (Ethernet FINS)

HMI Setting:

Parameters	Recommended	Options	Notes
PLC type	OMRON FINS (Ethernet)		
PLC I/F	Ethernet		
Port no.	9600		
PLC sta. no.	0		

PLC Setting:

Communication mode	FINS Ethernet protocol
--------------------	------------------------

Device Address:

Bit/Word	Device type	Format	Range	Memo
B	CIO_Bit	DDDDDDdd	0 ~ 3276715	Channel I/O (CIO)
B	W_Bit	DDDDDDdd	0 ~ 3276715	Work Area (WR)
B	H_Bit	DDDDDDdd	0 ~ 3276715	Holding Area (HR)
B	A_Bit	DDDDDDdd	0 ~ 3276715	Auxiliary Relay (AR) (Read only)
B	D_Bit	DDDDDDdd	0 ~ 3276715	Data Memory (DM)
B	T_Bit	DDDDDDdd	0 ~ 3276715	Timer (TIM)
B	C_Bit	DDDDDDdd	0 ~ 3276715	Counter (CNT)
B	C_Flag	DDDD	0 ~ 4095	
B	T_Flag	DDDD	0 ~ 4095	
W	CIO	DDDDD	0 ~ 32767	Channel I/O (CIO)
W	W	DDDDD	0 ~ 32767	Work Area (WR)
W	H	DDDDD	0 ~ 32767	Holding Area (HR)
W	A	DDDDD	0 ~ 32767	Auxiliary Relay (AR) (Read only)
W	C	DDDDD	0 ~ 32767	Counter (CNT)
W	T	DDDDD	0 ~ 32767	Timer (TIM)
W	D	DDDDD	0 ~ 32767	Data Memory (DM)
W	EM0 ~ EMC	DDDDD	0 ~ 32767	Extend Memory

Wiring Diagram:

Direct connect (crossover cable):

HMI RJ45 Male	Wire Color	Wire Color	PLC RJ45 Male
1 TX+	White/Orange	White/Green	3 RX+
2 TX-	Orange	Green	6 RX-
3 RX+	White/Green	White/Orange	1 TX+
4 BD4+	Blue	Blue	4 BD4+
5 BD4-	White/Blue	White/Blue	5 BD4-
6 RX-	Green	Orange	2 TX-
7 BD3+	White/Brown	White/Brown	7 BD3+
8 BD3-	Brown	Brown	8 BD3-



Through a hub:

HMI RJ45 Male	Wire Color	Wire Color	PLC RJ45 Male
1 TX+	White/Orange	White/Orange	1 TX+
2 TX-	Orange	Orange	2 TX-
3 RX+	White/Green	White/Green	3 RX+
4 BD4+	Blue	Blue	4 BD4+
5 BD4-	White/Blue	White/Blue	5 BD4-
6 RX-	Green	Green	6 RX-
7 BD3+	White/Brown	White/Brown	7 BD3+
8 BD3-	Brown	Brown	8 BD3-



Driver Version:

Version	Date	Description
V1.00	May/26/2011	Driver released.

OMRON Host Link

Supported Series: OMRON C, CPM, CPL, CQM Series (Host Link Protocol)

Website: <http://oeiweb.omron.com/oei/Products-PLC.htm>

HMI Setting:

Parameters	Recommended	Options	Notes
PLC type	OMRON Host Link		
PLC I/F	RS232	RS232, RS422, RS485	
Baud rate	9600	9600, 19200	
Data bits	7	7 or 8	
Parity	Even	Even, Odd, None	
Stop bits	2	1 or 2	
PLC sta. no.	0	0-31	Host Link Station No.

Online simulator	YES	Broadcast command	YES
Extend address mode	YES		

PLC Setting:

Communication mode	Host Link Protocol
--------------------	--------------------

Device Address:

Bit/Word	Device type	Format	Range	Memo
B	IR	DDDDdd	0 ~ 409515	I/O and Internal Relay
B	HR	DDDDdd	0 ~ 409515	Hold Relay
B	LR	DDDDdd	0 ~ 409515	Link Relay
B	IR (Force Set/Reset)	DDDDdd	0 ~ 409515	
B	HR (Force Set/Reset)	DDDDdd	0 ~ 409515	
B	LR (Force Set/Reset)	DDDDdd	0 ~ 409515	
B	AR	DDDDdd	0 ~ 409515	Auxiliary Relay
W	AR_W	DDDD	0 ~ 4095	
W	IR_W	DDDD	0 ~ 4095	
W	HR_W	DDDD	0 ~ 4095	
W	LR_W	DDDD	0 ~ 4095	
W	TC	DDD	0 ~ 255	
W	DM	DDDD	0 ~ 9999	Data Register

Wiring Diagram:

The following represents the view of HMI & PLC.



CPU Port (CPM2A,CQM1/1H,C200H/HS/ALPHA series)

Communication Module:





CPM1-CIF01 adapter (for CPM1/CPM1A/CPM2A series, CQM1/CQM1H series)

CPM1H-SCB41 communication module (for CQM1H-CPU51/61)



eMT3000 series

COM1 RS232 9P D-Sub Female	COM3 RS232 9P D-Sub Female		RS232 9P D-Sub Male
2 RX	8 RX		2 SD
3 TX	7 TX		3 RD
5 GND	5 GND		9 GND
			4 RS
			5 CS
			circuit
			

MT6000/8000 series except MT6050i/MT8050i

COM1 RS232 9P D-Sub Female	COM2 RS232 9P D-Sub Female	COM3 RS232 9P D-Sub Male	RS232 9P D-Sub Male
2 RX	6 RX	8 RX	2 SD
3 TX	4 TX	7 TX	3 RD
5 GND	5 GND	5 GND	9 GND
			4 RS
			5 CS
			circuit
			

MT6050i/MT8050i



COM1 RS232 9P D-Sub Female			RS232 9P D-Sub Male
9 RX			2 SD
6 TX			3 RD
5 GND			9 GND
			4 RS
			5 CS
			circuit
			

The following represents the view of HMI & PLC.





C200h-LK201,3G2A6-LK201 communication module

C200HW-COM02/03/04/05/06 communication module



eMT3000 series

COM1 RS232 9P D-Sub Female	COM3 RS232 9P D-Sub Female		RS232 9P D-Sub Male
2 RX	8 RX		2 SD
3 TX	7 TX		3 RD
5 GND	5 GND		7 GND
			4 RS
			5 CS
			circuit
			

MT6000/8000 series except MT6050i/MT8050i

COM1 RS232 9P D-Sub Female	COM2 RS232 9P D-Sub Female	COM3 RS232 9P D-Sub Male	RS232 9P D-Sub Male
2 RX	6 RX	8 RX	2 SD
3 TX	4 TX	7 TX	3 RD
5 GND	5 GND	5 GND	7 GND
			4 RS
			5 CS
			circuit
			

MT6050i/MT8050i

COM1 RS232 9P D-Sub Female			RS232 9P D-Sub Male
9 RX			2 SD
6 TX			3 RD
5 GND			7 GND
			4 RS
			5 CS
			circuit
			

Driver Version:

Version	Date	Description
V1.30	OCT/21/2010	

Panasonic FP

Supported Series: NAIS (Matsushita) FP series include FP-X, FP-Σ, FP0, FP1, FP2, FP2SH, FP10SH and FP3 Ethernet support FP-X with AFPX-COM5.

Website: <http://pewa.panasonic.com/>

HMI Setting:

Parameters	Recommended	Options	Notes
PLC type	Panasonic FP		
PLC I/F	RS232	RS232/RS485	
Baud rate	9600	9600, 19200, 38400,	
Data bits	8	7 or 8	
Parity	Odd	Even, Odd, None	
Stop bits	1	1 or 2	
PLC sta. no.	1	0-255	Must match the PLC port setting. FP3 must set to 0.

Device Address:



Bit/Word	Device type	Format	Range	Memo
B	X	DDDDh	0 ~ 9999f	Input (X)
B	Y	DDDDh	0 ~ 9999f	Output (Y)
B	R	DDDDh	0 ~ 9999f	Internal Relay (R)
B	L	DDDD	0 ~ 9999	Link Relay (L)
B	L_Bit	DDDDh	0 ~ 9999f	
B	T	DDDD	0 ~ 9999	Timer (T)
B	C	DDDD	0 ~ 9999	Counter (C)
W	SV	DDDD	0 ~ 9999	Timer/Counter Set Value (SV)
W	EV	DDDDD	0 ~ 65535	Timer/Counter Elapse Value (EV)
W	DT	DDDDD	0 ~ 99999	Data Register (DT)
W	LD	DDDD	0 ~ 8447	Link Register (LD)
W	WX	DDDD	0 ~ 9999	Input (WX) (read only)
W	WY	DDDD	0 ~ 9999	Output (WY)
W	WR	DDDD	0 ~ 9999	Internal Relay (WR)
W	WL	DDDD	0 ~ 9999	Link Relay (WL)
W	FL	DDDDD	0 ~ 99999	File Register (FL)

Wiring Diagram:





The following represents the view of HMI & PLC.

FP0, FP2, FP2SH, FPM CPU : 9P D-Sub to 5P Mini-DIN



eMT3000 series

COM1 RS232 9P D-Sub Female	COM3 RS232 9P D-Sub Female		RS232 5P Mini-DIN Male
2 RX	8 RX		2 TXD
3 TX	7 TX		3 RXD
5 GND	5 GND		1 GND
			

MT6000/8000 series except MT6050i/MT8050i

COM1 RS232 9P D-Sub Female	COM2 RS232 9P D-Sub Female	COM3 RS232 9P D-Sub Male	RS232 5P Mini-DIN Male
2 RX	6 RX	8 RX	2 TXD
3 TX	4 TX	7 TX	3 RXD
5 GND	5 GND	5 GND	1 GND
			



MT6050i/MT8050i

COM1 RS232 9P D-Sub Female			RS232 5P Mini-DIN Male
9 RX			2 TXD
6 TX			3 RXD
5 GND			1 GND
			





The following represents the view of HMI & PLC.

FP0 CPU : 9P D-Sub to 3P Terminal:



eMT3000 series

COM1 RS232 9P D-Sub Female	COM3 RS232 9P D-Sub Female		RS232 3P Terminal
2 RX	8 RX		S
3 TX	7 TX		R
5 GND	5 GND		G
			

MT6000/8000 series except MT6050i/MT8050i



COM1 RS232 9P D-Sub Female	COM2 RS232 9P D-Sub Female	COM3 RS232 9P D-Sub Male	RS232 3P Terminal
2 RX	6 RX	8 RX	S
3 TX	4 TX	7 TX	R
5 GND	5 GND	5 GND	G
			

MT6050i/MT8050i





COM1 RS232 9P D-Sub Female			RS232 3P Terminal
9 RX			S
6 TX			R
5 GND			G
			

The following represents the view of HMI & PLC.



eMT3000 series

COM1 RS232 9P D-Sub Female	COM3 RS232 9P D-Sub Female		RS232 9P D-Sub Male
2 RX	8 RX		2 TXD
3 TX	7 TX		3 RXD
5 GND	5 GND		7 GND
			4 RTS
			5 CTS
			8 CD
			9 ER
			circuit
			circuit
			

MT6000/8000 series except MT6050i/MT8050i

COM1 RS232 9P D-Sub Female	COM2 RS232 9P D-Sub Female	COM3 RS232 9P D-Sub Male	RS232 9P D-Sub Male
2 RX	6 RX	8 RX	2 TXD
3 TX	4 TX	7 TX	3 RXD
5 GND	5 GND	5 GND	7 GND
			4 RTS
			5 CTS
			8 CD
			9 ER
			circuit
			circuit
			



MT6050i/MT8050i

COM1 RS232 9P D-Sub Female			RS232 9P D-Sub Male
9 RX			2 TXD
6 TX			3 RXD
5 GND			7 GND
			4 RTS
			5 CTS
			8 CD
			9 ER
			circuit
			circuit
			

The following represents the view of HMI & PLC.

FP1 CPU : 9P D-Sub to 8P MiniDIN

eMT3000 series

COM1 RS485 4W 9P D-Sub Male			RS485 4W 8P Hirose Male
1 RX-			2 TXDA
2 RX+			5 TXDB
3 TX-			3 RXDA
4 TX+			6 RXDB
5 GND			1 GND
			

MT6000/8000 series except MT6050i/MT8050i

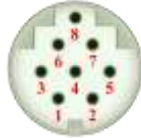
COM1 RS485 4W 9P D-Sub Male			RS485 4W 8P Hirose Male
1 RX-			2 TXDA
2 RX+			5 TXDB
3 TX-			3 RXDA
4 TX+			6 RXDB
5 GND			1 GND
			

MT6050i/MT8050i

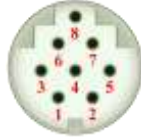
COM1 RS485 4W 9P D-Sub Female			RS485 4W 8P Hirose Male
1 RX-			2 TXDA
2 RX+			5 TXDB
3 TX-			3 RXDA
4 TX+			6 RXDB
5 GND			1 GND
			

The following represents the view of HMI & PLC.

FP3 CPU : 9P D-Sub to 15P D-Sub

eMT3000 series

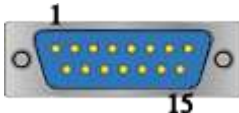
COM1 RS485 4W 9P D-Sub Male			RS485 4W 15P D-Sub Male
1 RX-			9 TXDA
2 RX+			2 TXDB
3 TX-			10 RXDA
4 TX+			3 RXDB
5 GND			7 GND
			4 RTS+
			5 CTS+
			11 RTS-
			12 CTS-
			circuit
			circuit
			

MT6000/8000 series except MT6050i/MT8050i

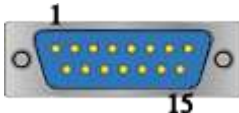
COM1 RS485 4W 9P D-Sub Male			RS485 4W 15P D-Sub Male
1 RX-			9 TXDA
2 RX+			2 TXDB
3 TX-			10 RXDA
4 TX+			3 RXDB
5 GND			7 GND
			4 RTS+
			5 CTS+
			11 RTS-
			12 CTS-
			circuit
			circuit
			

MT6050i/MT8050i

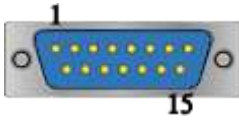
COM1 RS485 4W 9P D-Sub Female			RS485 4W 15P D-Sub Male
1 RX-			9 TXDA
2 RX+			2 TXDB
3 TX-			10 RXDA
4 TX+			3 RXDB
5 GND			7 GND
			4 RTS+
			5 CTS+
			11 RTS-
			12 CTS-
			circuit
			circuit
			

Driver Version:

Version	Date	Description
V1.80	Apr/09/2010	Added registers: FL

Panasonic FP (Ethernet)

Supported Series: NAIS (Matsushita) FP series include FP-X, FP-Σ, FP0, FP1, FP2, FP2SH, FP10SH and FP3 Ethernet support FP-X with AFPX-COM5.

Website: <http://pewa.panasonic.com/>

HMI Setting:

Parameters	Recommended	Options	Notes
PLC type	Panasonic FP (Ethernet)		
PLC I/F	Ethernet		
Port no.	9094		
PLC sta. no.	1	0~255	

Device Address:

Bit/Word	Device type	Format	Range	Memo
B	X	DDDDh	0 ~ 9999f	Input (X)
B	Y	DDDDh	0 ~ 9999f	Output (Y)
B	R	DDDDh	0 ~ 9999f	Internal Relay (R)
B	L	DDDD	0 ~ 9999	Link Relay (L)
B	L_Bit	DDDDh	0 ~ 9999f	
B	T	DDDD	0 ~ 9999	Timer (T)
B	C	DDDD	0 ~ 9999	Counter (C)
W	SV	DDDD	0 ~ 9999	Timer/Counter Set Value (SV)
W	EV	DDDDD	0 ~ 65535	Timer/Counter Elapse Value (EV)
W	DT	DDDDD	0 ~ 99999	Data Register (DT)
W	LD	DDDD	0 ~ 8447	Link Register (LD)
W	WX	DDDD	0 ~ 9999	Input (WX) (read only)
W	WY	DDDD	0 ~ 9999	Output (WY)
W	WR	DDDD	0 ~ 9999	Internal Relay (WR)
W	WL	DDDD	0 ~ 9999	Link Relay (WL)
W	FL	DDDDD	0 ~ 99999	File Register (FL)

Wiring Diagram:

Direct connect (crossover cable):

HMI RJ45 Male	Wire Color	Wire Color	PLC RJ45 Male
1 TX+	White/Orange	White/Green	3 RX+
2 TX-	Orange	Green	6 RX-
3 RX+	White/Green	White/Orange	1 TX+
4 BD4+	Blue	Blue	4 BD4+
5 BD4-	White/Blue	White/Blue	5 BD4-
6 RX-	Green	Orange	2 TX-
7 BD3+	White/Brown	White/Brown	7 BD3+
8 BD3-	Brown	Brown	8 BD3-



Through a hub:

HMI RJ45 Male	Wire Color	Wire Color	PLC RJ45 Male
1 TX+	White/Orange	White/Orange	1 TX+
2 TX-	Orange	Orange	2 TX-
3 RX+	White/Green	White/Green	3 RX+
4 BD4+	Blue	Blue	4 BD4+
5 BD4-	White/Blue	White/Blue	5 BD4-
6 RX-	Green	Green	6 RX-
7 BD3+	White/Brown	White/Brown	7 BD3+
8 BD3-	Brown	Brown	8 BD3-



Ethernet Connection TCP Port: 9094



Driver Version:

Version	Date	Description
V1.80	Apr/12/2010	

Panasonic FP2 (Ethernet)

Supported Series: NAIS (Matsushita) FP2 series include FP2, FP2SH, and FP10SH CPU.

Website: <http://pewa.panasonic.com/>

HMI Setting:

Parameters	Recommended	Options	Notes
PLC type	Panasonic FP2 (Ethernet)		
PLC I/F	Ethernet		
Port no.	8500		
PLC sta. no.	2	0~255	

Device Address:

Bit/Word	Device type	Format	Range	Memo
B	X	DDDDh	0 ~ 9999f	Input (X)
B	Y	DDDDh	0 ~ 9999f	Output (Y)
B	R	DDDDh	0 ~ 9999f	Internal Relay (R)
B	L	DDDD	0 ~ 9999	Link Relay (L)
B	L_Bit	DDDDh	0 ~ 9999f	
B	T	DDDD	0 ~ 9999	Timer (T)
B	C	DDDD	0 ~ 9999	Counter (C)
W	SV	DDDD	0 ~ 9999	Timer/Counter Set Value (SV)
W	EV	DDDDD	0 ~ 65535	Timer/Counter Elapse Value (EV)
W	DT	DDDDD	0 ~ 99999	Data Register (DT)
W	LD	DDDD	0 ~ 8447	Link Register (LD)
W	WX	DDDD	0 ~ 9999	Input (WX) (read only)
W	WY	DDDD	0 ~ 9999	Output (WY)
W	WR	DDDD	0 ~ 9999	Internal Relay (WR)
W	WL	DDDD	0 ~ 9999	Link Relay (WL)

Wiring Diagram:

Direct connect (crossover cable):

HMI RJ45 Male	Wire Color	Wire Color	PLC RJ45 Male
1 TX+	White/Orange	White/Green	3 RX+
2 TX-	Orange	Green	6 RX-
3 RX+	White/Green	White/Orange	1 TX+
4 BD4+	Blue	Blue	4 BD4+
5 BD4-	White/Blue	White/Blue	5 BD4-
6 RX-	Green	Orange	2 TX-
7 BD3+	White/Brown	White/Brown	7 BD3+
8 BD3-	Brown	Brown	8 BD3-



Through a hub:

HMI RJ45 Male	Wire Color	Wire Color	PLC RJ45 Male
1 TX+	White/Orange	White/Orange	1 TX+
2 TX-	Orange	Orange	2 TX-
3 RX+	White/Green	White/Green	3 RX+
4 BD4+	Blue	Blue	4 BD4+
5 BD4-	White/Blue	White/Blue	5 BD4-
6 RX-	Green	Green	6 RX-
7 BD3+	White/Brown	White/Brown	7 BD3+
8 BD3-	Brown	Brown	8 BD3-



Driver Version:

Version	Date	Description
V1.00	Mar/11/2010	Driver released.

Panasonic MINAS A4

Supported Series: Panasonic MINAS A4 series Servo Drive.

HMI Setting:

Parameters	Recommended	Options	Notes
PLC type	Panasonic MINAS A4		
PLC I/F	RS232		
Baud rate	9600	2400 ~ 57600	
Data bits	8		
Parity	None		
Stop bits	1		
Axis no.	0 (master station only)	0 ~ F (slave)	

Device Address:

Bit/Word	Device type	Format	Range	Memo
B	Command 20	D	0 ~ 7	States (Note 3)
B	Command 27	DD	0 ~ 31	Input Signal (Note 3)
B	Command 28	DD	0 ~ 31	Output Signal (Note 3)
W	Command 01	D	0	CPU Version (Numeric format:16-bit Hex)
W	Command 05	DD	0 ~ 11	Driver Version (ASCII / 12 words)
W	Command 06	DD	0 ~ 11	Motor Version (ASCII / 12 words)
W	Command 21	D	0 ~ 1	command pulse counter (Numeric format: 32-bit Signed)
W	Command 22	D	0 ~ 1	feedback pulse counter (Numeric format: 32-bit Signed)
W	Command 24	D	0	present speed (Numeric format: 16-bit Unsigned)
W	Command 25	D	0	present torque (Numeric format: 16-bit Unsigned)
W	Command 26	D	0 ~ 1	present deviation counter (Numeric format: 32-bit Signed)
W	Command 84	D	0	write parameter to EEPROM (Note 1)

Bit/Word	Device type	Format	Range	Memo
W	Command 90	D	0	present Alarm Data (Numeric format: 16-bit Unsigned)
W	Command 91	DD	1 ~ 14	Alarm History (Note 4) (Numeric format: 16-bit Unsigned)
W	Command 92	DD	1 ~ 14	Batch Alarm (Note 4) (Numeric format: 16-bit Unsigned)
W	Command 93	D	0	clear Alarm History (include EEPROM) (Note 1)
W	Command 94	D	0	Alarm Clear (Note 1)
W	Command 9B	D	0	Absolute Clear (Note 1)
W	Parameter	HH	0 ~ 7f	Individual Parameter (range: 0x00 ~ 0x7F) (Note 2)
W	Comm2D_S	D	0 ~ 1	Command 2D Single turn data (Numeric format: 32-bit Signed)
W	Comm2D_M	D	0 ~ 1	Command 2D Multi-turn data (Numeric format: 32-bit Signed)

Note:



1. Command 84, Command 93, Command 94, and Command 9B are write only. (These commands are able to use Set Bit Object and execute the write command after triggering Set Bit Object.). Commands other than these four are read only.
2. Parameter read/write: Use device type to define address control from 00~7F.
For example: "address_00" is mapping to "Parameter_00".
(Please refer to Panasonic MINAS A4 Series User Manual.)
3. Device address type can define MINAS A4 Driver's command list.
Command 20, Command 27, and Command 28 are Bit type, use "Operating range" to map communication order status.
For example: "Command 20_3" means "Read state_CCW".
(Please refer to Panasonic MINAS A4 Series User Manual.)
4. Command 91 and Command 92 are word type, use "Operating range" to map the record of 14 alarms.
For example: "Command 91_1" means "Read alarm data_First alarm".

Wiring Diagram:





The following represents the view of HMI & PLC.

MINAS A4 Driver CNX4 Port



eMT3000 series

COM1 RS232 9P D-Sub Female	COM3 RS232 9P D-Sub Female		RS232 8P Mini-DIN Male
2 RX	8 RX		3 TXD
3 TX	7 TX		5 RXD
5 GND	5 GND		4 GND
			

MT6000/8000 series except MT6050i/MT8050i

COM1 RS232 9P D-Sub Female	COM2 RS232 9P D-Sub Female	COM3 RS232 9P D-Sub Male	RS232 8P Mini-DIN Male
2 RX	6 RX	8 RX	3 TXD
3 TX	4 TX	7 TX	5 RXD
5 GND	5 GND	5 GND	4 GND
			

MT6050i/MT8050i

COM1 RS232 9P D-Sub Female			RS232 8P Mini-DIN Male
9 RX			3 TXD
6 TX			5 RXD
5 GND			4 GND
			

 <p>8P Mini-Din Male MINAS A4 Driver CNX3 / CNX4 Port</p>	MINAS A4 Driver CNX3 Port	MINAS A4 Driver CNX4 Port
		3 TX
		5 RX
	4 GND	4 GND
	7 D-	7 D-
	8 D+	8 D+

RS485 cable / DVOP1970-005

MINAS A4 Driver 8p Mini-DIN Male		MINAS A4 Driver 8p Mini-DIN Male
7 D-	—	7 D-
8 D+	—	8 D+
4 GND	—	4 GND

RS232 cable / DVOP1960

MINAS A4 Driver 9P D-SUB Female		MINAS A4 Driver 8p Mini-DIN Male
3 RXD	—	5 RXD
2 TXD	—	3 TXD
5 GND	—	4 GND

HMI connect with one Device

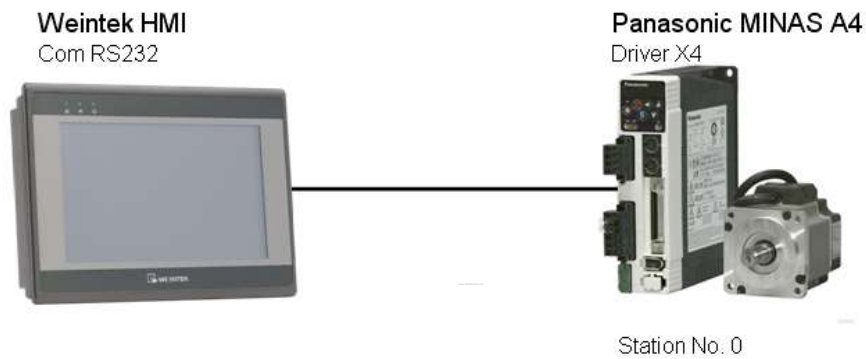

HMI connect with multi devices



Driver Version:

Version	Date	Description
V1.10	Jan/11/2010	
V1.20	Jul/25/2012	Added registers : Comm2D_S and Comm2D_M.

Panasonic MINAS A5

Supported Series: Panasonic MINAS A5 series Servo Drive.

HMI Setting:

Parameters	Recommended	Options	Notes
PLC type	Panasonic MINAS A5		
PLC I/F	RS232	RS232/RS485 2W	
Baud rate	9600	2400~115200	
Data bits	8		
Parity	None		
Stop bits	1		
Axis no.	0 (master station only)	0 ~ 127 (slave)	

* When connecting with more than two devices, it is recommended to set timeout to more than 4 seconds. Set a longer timeout when connecting with more devices to maintain good communication.

Device Address:

Bit/Word	Device type	Format	Range	Memo
B	Command 20	D	0 ~ 7	States (Note 3)
B	Command 27	DD	0 ~ 31	Input Signal (Note 3)
B	Command 28	DD	0 ~ 31	Output Signal (Note 3)
W	Command 01	D	0	CPU Version (Numeric format: 16-bit Hex)
W	Command 05	DD	0 ~ 11	Driver Version (ASCII / 12 words)
W	Command 06	DD	0 ~ 11	Motor Version (ASCII / 12 words)
W	Command 21	D	0 ~ 1	command pulse counter (Numeric format: 32-bit Signed)
W	Command 22	D	0 ~ 1	feedback pulse counter (Numeric format: 32-bit Signed)
W	Command 24	D	0	present speed (Numeric format: 16-bit Unsigned)
W	Command 25	D	0	present torque (Numeric format: 16-bit Unsigned)

Bit/Word	Device type	Format	Range	Memo
W	Command 26	D	0 ~ 1	present deviation counter (Numeric format: 32-bit Signed)
W	Command 72	D	0	write parameter to EEPROM (Note 1)
W	Command 90	D	0	present Alarm Data (Numeric format: 16-bit Unsigned)
W	Command 92	DD	1 ~ 14	Batch Alarm (Note 4) (Numeric format: 16-bit Unsigned)
W	Command 93	D	0	clear Alarm History (include EEPROM) (Note 1)
W	Command 94	D	0	Alarm Clear (Note 1)
W	Command 9B	D	0	Absolute Clear (Note 1)
W	Parameter	HHH	0 ~ 639	Individual Parameter (range: 0x000 ~ 0x639) (Note 2)

Note:



1. Command 72, Command 93, Command 94, and Command 9B are write only. (These commands are able to use Set Bit Object and execute the write command after triggering Set Bit Object.). Commands other than these four are read only.
2. Parameter read/write: Use device type to define address control from 000~639.
For example: "address_000" is mapping to "Parameter_000".
(Please refer to Panasonic MINAS A5 Series User Manual.)
3. Device address type can define MINAS A5 Driver's command list.
Command 20, Command 27, and Command 28 are Bit type, use "Operating range" to map communication order status.
For example: "Command 20_3" means "Read state_CCW".
(Please refer to Panasonic MINAS A5 Series User Manual.)
4. Command 92 are word type, use "Operating range" to map the record of 14 alarms.

Wiring Diagram:



The following represents the view of HMI & PLC.

MINAS A5 Driver X2 Port RS232 Signal

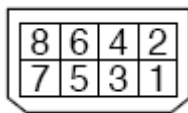
eMT3000 series

COM1 RS232 9P D-Sub Female	COM3 RS232 9P D-Sub Female		RS232 8P Connector
2 RX	8 RX		3 TXD
3 TX	7 TX		4 RXD
5 GND	5 GND		1 GND
			

MT6000/8000 series except MT6050i/MT8050i

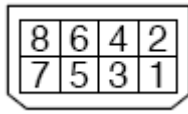
COM1 RS232 9P D-Sub Female	COM2 RS232 9P D-Sub Female	COM3 RS232 9P D-Sub Male	RS232 8P Connector
2 RX	6 RX	8 RX	3 TXD
3 TX	4 TX	7 TX	4 RXD
5 GND	5 GND	5 GND	1 GND
			

MT6050i/MT8050i

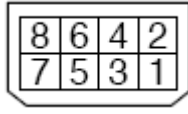
COM1 RS232 9P D-Sub Female			RS232 8P Connector
9 RX			3 TXD
6 TX			4 RXD
5 GND			1 GND
			



The following represents the view of HMI & PLC.

MINAS A5 Driver X2 Port RS485 Signal

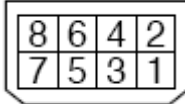

eMT3000 series

COM1 RS485 2W 9P D-Sub Male	COM3 RS485 2W 9P D-Sub Male		RS485 2W 8P Connector
1 RX-	6 Data-		5,7 485-
2 RX+	9 Data+		6,8 485+
5 GND	5 GND		1 GND
			

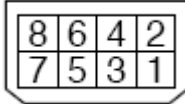
MT6000/8000 series except MT6050i/MT8050i

COM1 RS485 2W 9P D-Sub Male	COM3 RS485 2W 9P D-Sub Male		RS485 2W 8P Connector
1 RX-	6 Data-		5,7 485-
2 RX+	9 Data+		6,8 485+
5 GND	5 GND		1 GND
			

MT6050i/MT8050i

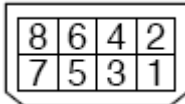
COM1 RS485 2W 9P D-Sub Female	COM3 RS485 2W 9P D-Sub Female		RS485 2W 8P Connector
1 RX-	7 Data-		5,7 485-
2 RX+	8 Data+		6,8 485+
5 GND	5 GND		1 GND
			

Driver Version:

Version	Date	Description
V1.00	May/23/2012	Driver released.

Parker ACR9000

Supported Series: Parker ACR9000.

Website: <http://www.parkermotion.com>

HMI Setting:

Parameters	Recommended	Options	Notes
PLC type	Parker ACR9000		
PLC I/F	RS232	RS485 4W / RS232	
Baud rate	38400	1200 - 38400	
Data bits	8	7,8	
Parity	None	Even, Odd, None	
Stop bits	1	1,2	
PLC sta. no.	0		

Online simulator	YES	Extend address mode	
------------------	-----	---------------------	--



Device Address:

Bit/Word	Device type	Format	Range	Memo
B	P_Low16bit	DDDDDDdd	0 ~ 9999915	
B	P_High16bit	DDDDDDdd	0 ~ 9999915	
W	P_Int32	DDDDDD	0 ~ 99999	
W	P_Float	DDDDDD	0 ~ 99999	





Wiring Diagram:

The following represents the view of HMI & PLC.



eMT3000 series

COM1 RS232 9P D-Sub Female	COM3 RS232 9P D-Sub Female		Parker AC9000 RS232 9P D-Sub Male
2 RX	8 RX		3 TXD
3 TX	7 TX		2 RXD
5 GND	5 GND		5 GND
			

MT6000/8000 series except MT6050i/MT8050i

COM1 RS232 9P D-Sub Female	COM2 RS232 9P D-Sub Female	COM3 RS232 9P D-Sub Male	Parker AC9000 RS232 9P D-Sub Male
2 RX	6 RX	8 RX	3 TXD
3 TX	4 TX	7 TX	2 RXD
5 GND	5 GND	5 GND	5 GND
			

MT6050i/MT8050i

COM1 RS232 9P D-Sub Female			Parker AC9000 RS232 9P D-Sub Male
9 RX			3 TXD
6 TX			2 RXD
5 GND			5 GND
			

Driver Version:

Version	Date	Description
V1.00	Dec/30/2008	Driver released.

Parker Compax3

Supported Series: Parker Compax3 Servo Drive.

Website: <http://www.parker.com>

HMI Setting:

RS232

Parameters	Recommended	Options	Notes
PLC type	Parker Compax3		
PLC I/F	RS232		
Baud rate	115200		
Data bits	8	7 or 8	
Parity	None	Even, Odd, None	
Stop bits	1	1 or 2	
PLC sta. no.	0	0	Must be 0 for RS232

RS485

Parameters	Recommended	Options	Notes
PLC type	Parker Compax3		
PLC I/F	RS485 2W		
Baud rate	9600		
Data bits	8	7 or 8	
Parity	None	Even, Odd, None	
Stop bits	1	1 or 2	
PLC sta. no.	1	1-99	Range from 1 to 99 for RS485, according to the PLC setting.

PLC Setting:

How to set Compax 3 servo to RS485 mode?

1. Open C3 ServoManager2, select "Communication" => "RS-485 Settings".

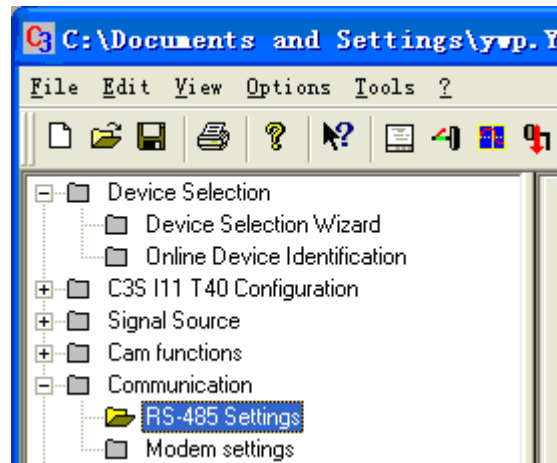

2. Click to Configure "RS-485/POP Settings".

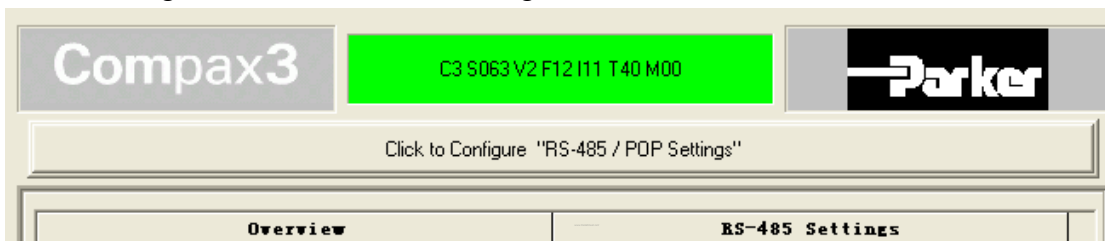

3. Set parameters as below:

RS-485 Settings

Master	General
Multicast Address	98
Device Address	1
Baud rate	9600
Connection Type	Two wire
Parity	No
Stop bits	1
Data bits	8

4. Download settings to Compax3 Servo.

5. Set EasyBuilder system parameter and connect with PLC for communication of HMI and Servo.

Device Address:



Bit/Word	Device type	Format	Range	Memo
B	R_Low16bit	DDDDDDDDh	0 ~ 9999999f	
B	R_High16bit	DDDDDDDDh	0 ~ 9999999f	
DW	Register_Int	DDDDDD	0 ~ 999999	For Register INT32, U32
DW	Register_float	DDDDDD	0 ~ 999999	For Register INT32, U32
W	Register_Short	DDDDDD	0 ~ 999999	For Register INT16, U16

Wiring Diagram:





The following represents the view of HMI & PLC.

Parker Compax3 PLC X10 : RS232



eMT3000 series

COM1 RS232 9P D-Sub Female	COM3 RS232 9P D-Sub Female		RS232 9P D-Sub Male
2 RX	8 RX		3 TXD
3 TX	7 TX		2 RXD
5 GND	5 GND		5 GND
			

MT6000/8000 series except MT6050i/MT8050i

COM1 RS232 9P D-Sub Female	COM2 RS232 9P D-Sub Female	COM3 RS232 9P D-Sub Male	RS232 9P D-Sub Male
2 RX	6 RX	8 RX	3 TXD
3 TX	4 TX	7 TX	2 RXD
5 GND	5 GND	5 GND	5 GND
			



MT6050i/MT8050i

COM1 RS232 9P D-Sub Female			RS232 9P D-Sub Male
9 RX			3 TXD
6 TX			2 RXD
5 GND			5 GND
			



The following represents the view of HMI & PLC.

Parker Compax3 PLC X10 : RS485 2W



eMT3000 series

COM1 RS485 2W 9P D-Sub Male	COM3 RS485 2W 9P D-Sub Male		RS485 2W 9P D-Sub Male
1 RX-	6 Data-		3 RXD
2 RX+	9 Data+		7 TXD
5 GND	5 GND		5 GND
			1 nable RS485
			9 +5V
			circuit
			

MT6000/8000 series except MT6050i/MT8050i

COM1 RS485 2W 9P D-Sub Male	COM3 RS485 2W 9P D-Sub Male		RS485 2W 9P D-Sub Male
1 RX-	6 Data-		3 RXD
2 RX+	9 Data+		7 TXD
5 GND	5 GND		5 GND
			1 nable RS485
			9 +5V
			circuit
			

MT6050i/MT8050i

COM1 RS485 2W 9P D-Sub Female	COM3 RS485 2W 9P D-Sub Female		RS485 2W 9P D-Sub Male
1 RX-	7 Data-		3 RXD
2 RX+	8 Data+		7 TXD
5 GND	5 GND		5 GND
			1 nable RS485 9 +5V
			circuit
			

Driver Version:

Version	Date	Description
V1.70	Mar/30/2009	

Parker Compumotor 6K Series

HMI Setting:

Parameters	Recommended	Options	Notes
PLC type	Parker Compumotor 6K Series		
PLC I/F	RS232		
Baud rate	9600		
Data bits	8		
Parity	None		
Stop bits	1		
PLC sta. no.	0		



Device Address:

Bit/Word	Device type	Format	Range	Memo
B	VARB(L)	DDDdd	1 ~ 125	The lower 16 bits data of VARB
B	VARB(H)	DDDdd	1 ~ 125	The higher 16 bits data of VARB
D	RUN_PRG	D	0 —	
DW	VARI	DDD	1 ~ 125	
DW	VAR	DDD	1 ~ 125	Must select single float data mode.





Wiring Diagram:

The following represents the view of HMI & PLC.



eMT3000 series

COM1 RS232 9P D-Sub Female	COM3 RS232 9P D-Sub Female		PLC RS232 9P D-Sub Male
2 RX	8 RX		3 TX
3 TX	7 TX		2 RX
5 GND	5 GND		5 GND
			

MT6000/8000 series except MT6050i/MT8050i

COM1 RS232 9P D-Sub Female	COM2 RS232 9P D-Sub Female	COM3 RS232 9P D-Sub Male	PLC RS232 9P D-Sub Male
2 RX	6 RX	8 RX	3 TX
3 TX	4 TX	7 TX	2 RX
5 GND	5 GND	5 GND	5 GND
			

MT6050i/MT8050i

COM1 RS232 9P D-Sub Female			PLC RS232 9P D-Sub Male
9 RX			3 TX
6 TX			2 RX
5 GND			5 GND
			

Driver Version:

Version	Date	Description
V1.00	Apr/7/2011	Driver released.

Parker SLVD Series

Supported Series : Parker SLVD Servo, SLVD1N, SLVD2N, SLVD5N, SLVD7N, SLVD10N, SLVD15N, SLVD17N.

Website: <http://www.parker.com/portal/site/PARKER/>

HMI Setting:

Parameters	Recommended	Options	Notes
PLC type	Parker SLVD Series		
PLC I/F	RS485 4W		
Baud rate	9600	9600/19200	
Data bits	8	7,8	
Parity	Even	Even, Odd, None	
Stop bits	1	1,2	
PLC sta. no.	0		0-31

Online simulator	YES	Extend address mode	
------------------	-----	---------------------	--

Device Address:

Bit/Word	Device type	Format	Range	Memo
B	Par_Binary	DDDDdd	0 ~ 999915	Set bit parameter
W	Par_One_Word	DDDD	0 ~ 9999	Set 2 bytes parameter
DW	Par_Two_Word	DDDD	0 ~ 9999	Set 4 bytes parameter
W	Par_One_Byte	DDDD	0 ~ 9999	Set 1 byte parameter
W	RESET	D	0	
W	RUN	D	0	

Wiring Diagram:

The following represents the view of HMI & PLC.

Parker SLVD Servo Serial Link X1

eMT3000 series

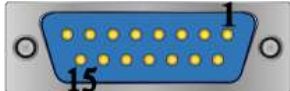
COM1 RS485 4W 9P D-Sub Male			RS485 4W 15P D-Sub Male
1 RX-			7 TX-
2 RX+			12 TX+
3 TX-			2 RX-
4 TX+			1 RX+
			6 TER
			circuit
5 GND			3 GND
			

MT6000/8000 series except MT6050i/MT8050i

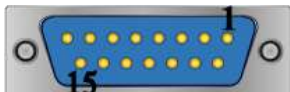
COM1 RS485 4W 9P D-Sub Male			RS485 4W 15P D-Sub Male
1 RX-			7 TX-
2 RX+			12 TX+
3 TX-			2 RX-
4 TX+			1 RX+
			6 TER
			circuit
5 GND			3 GND
			

MT6050i/MT8050i

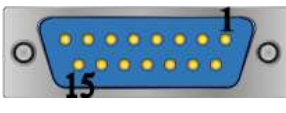
COM1 RS485 4W 9P D-Sub Female			RS485 4W 15P D-Sub Male
1 RX-			7 TX-
2 RX+			12 TX+
3 TX-			2 RX-
4 TX+			1 RX+
			6 TER
			3 GND
			

Driver Version:

Version	Date	Description
V1.00	Jan/27/2010	Driver released.

Rockwell CompactLogix - Free Tag Names

Website: <http://www.ab.com>

HMI Setting:

Parameters	Recommended	Options	Notes
PLC type	Allen-Bradley CompactLogix – Free Tag Names		
PLC I/F	RS232		
Baud rate	19200	9600, 19200, 38400	
Data bits	8	8	
Parity	None	Even, Odd, None	
Stop bits	1	1	
Turn around delay (ms)	10	10 ~ 100	*Note
HMI sta. no.	0		
PLC sta. no.	1	1-31	

*Note : When the communication is not stable, please adjust the parameter of [turn around delay] till the communication is normal.

PLC Setting:

Communication mode	DF1 Full Duplex protocol 19200, None, 8, 1 (default) Error Check: BCC, Station Address: 1
--------------------	--

1. Create new tags (Controller Tags and Program Tags supported).

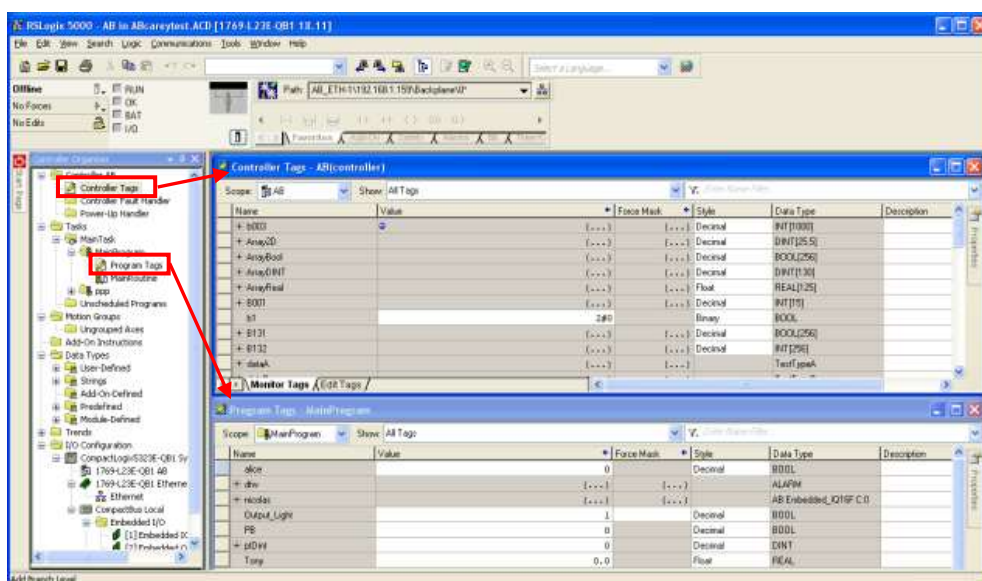

2. Export Tag data to CSV file. ([Tools] » [Export] » [Tags and Logic Comments])

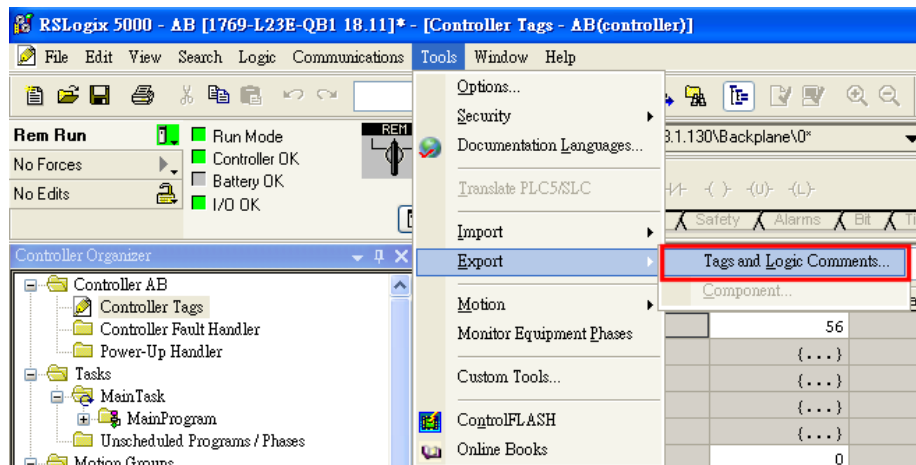

Note: The separator character in CSV file must be a comma “,” otherwise the file is invalid.

TAG	Array2D	DINT[25,5]	(RADIX := Decimal, Constant := false, ExternalAccess := Read/Write)
TAG	ArrayBool	BOOL[256]	(RADIX := Decimal, Constant := false, ExternalAccess := Read/Write)
TAG	ArrayDINT	DINT[130]	(RADIX := Decimal, Constant := false, ExternalAccess := Read/Write)

The directory of changing system settings: [Control Panel] » [Date, Time, Language, and Regional Options] » [Change the format of numbers, dates, and times] » [Customize] » [List separator]. Please select “,” and export CSV file after setting.

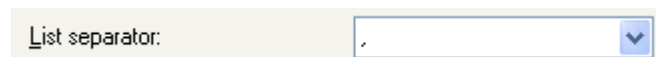

- Open EasyBuilder project file, select the driver and set communication parameter. Click **[Data Type]** to open **[Structure Editor]** and edit the data type of the tags.

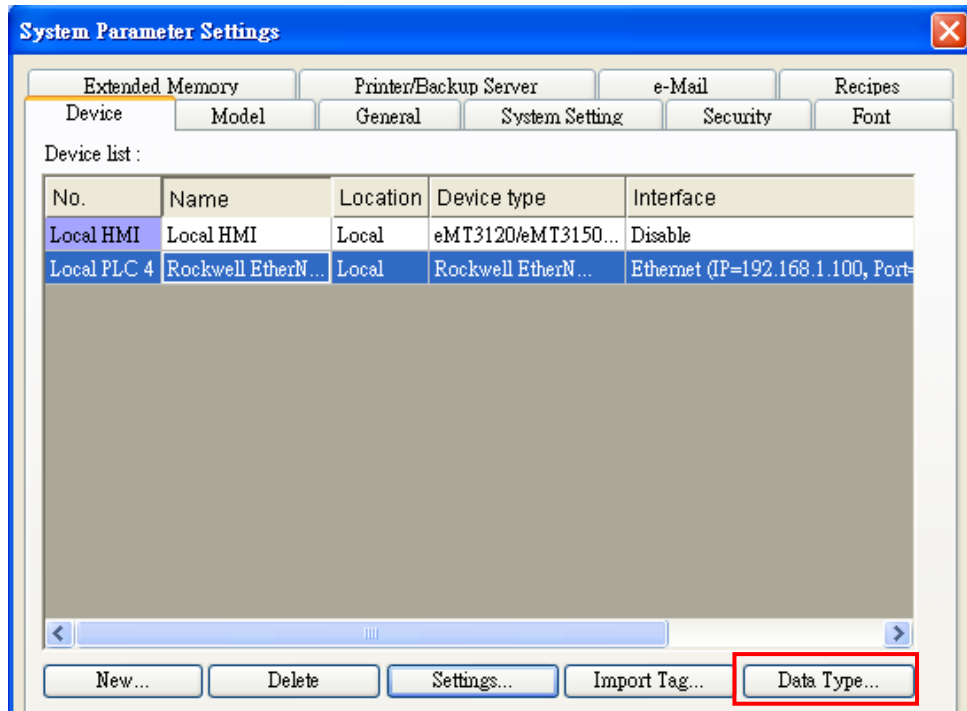

TYPE	SCOPE	NAME	DESCRIPTION	DATATYPE	SPECIFIER	ATTRIBUTES
TAG		Local:1:C		AB:Embedded_IQ16F:C:0		
TAG		Local:1:I		AB:Embedded_IQ16F:I:0		
TAG		Local:2:C		AB:Embedded_OB16:C:0		
TAG		Local:2:I		AB:Embedded_OB16:I:0		
TAG		Local:2:O		AB:Embedded_OB16:O:0		

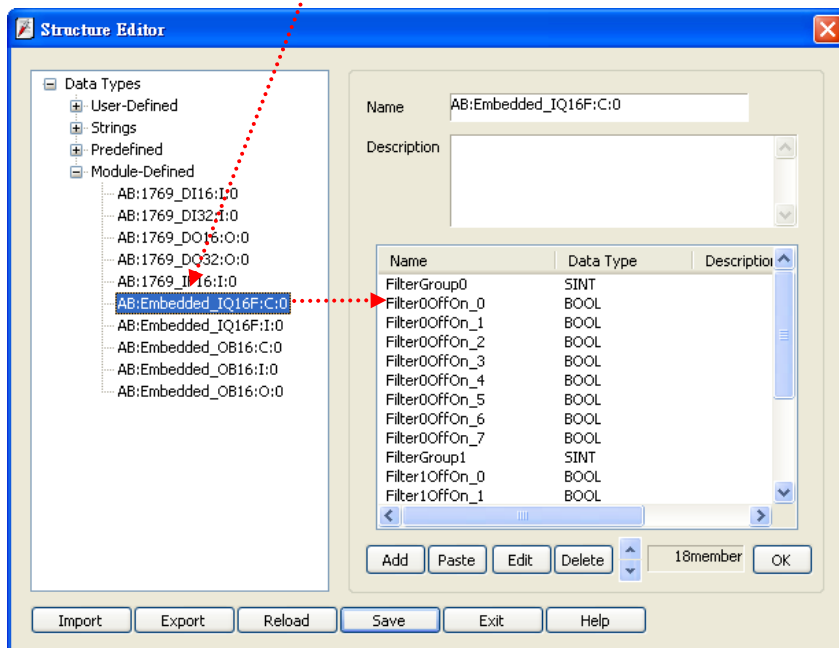

4. In **[Structure Editor]** edit the data type of **[Program Tag]**.

The imported csv file is shown below:

7	TYPE	SCOPE	NAME	DESCRIPTION	DATATYPE	SPECIFIER
8	TAG		Local:1:C		AB:Embedded_IQ16F:C:0	
9	TAG		Local:1:I		AB:Embedded_IQ16F:I:0	
10	TAG		Local:2:C		AB:Embedded_OB16:C:0	
11	TAG		Local:2:I		AB:Embedded_OB16:I:0	
12	TAG		Local:2:O		AB:Embedded_OB16:O:0	
13	TAG		PB_ControllerTag		BOOL	
14	TYPE	SCOPE	NAME	DESCRIPTION	DATATYPE	SPECIFIER
15	TAG	ConveyorProgram	Output_Conveyor			Local:2:O,Data.2
16	TAG	ConveyorProgram	PB_Conveyor		BOOL	
17	TYPE	SCOPE	NAME	DESCRIPTION	DATATYPE	SPECIFIER
18	TAG	MainProgram	Output_Light			Local:2:O,Data.1
19	TAG	MainProgram	PB		BOOL	

Step 1

Right click on **[Structure Editor]** » **[User-Defined]** to add a **[new data type]**.

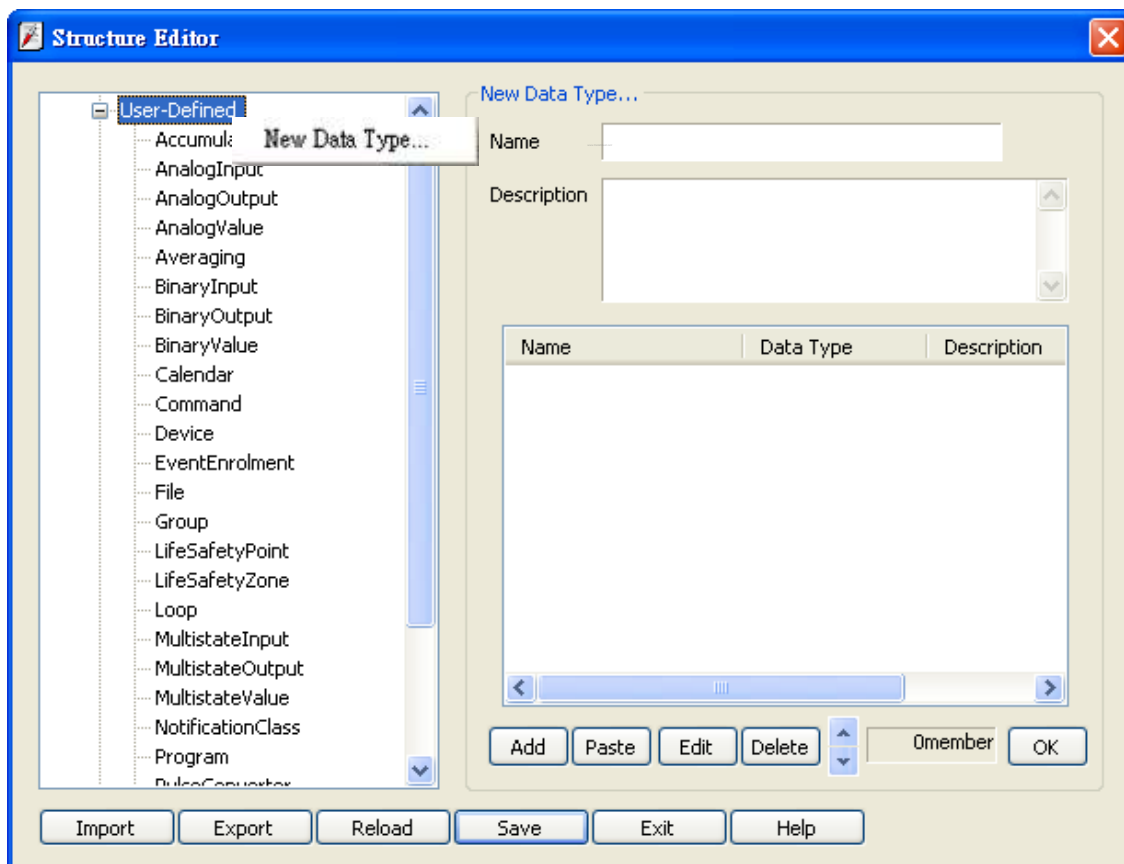

Step 2

After adding all Program Tags, click **[OK]** » **[Save]** » **[Exit]** to leave the editor dialog.

TYPE	SCOPE	NAME	DESCRIPTION	DATATYPE	SPECIFIER
ALIAS	ConveyorProgram	Output_Conveyor			Local:2:O.Data.2
TAG	ConveyorProgram	PB_Conveyor		BOOL	
TYPE	SCOPE	NAME	DESCRIPTION	DATATYPE	SPECIFIER
ALIAS	MainProgram	Output_Light			Local:2:O.Data.1
TAG	MainProgram	PB		BOOL	

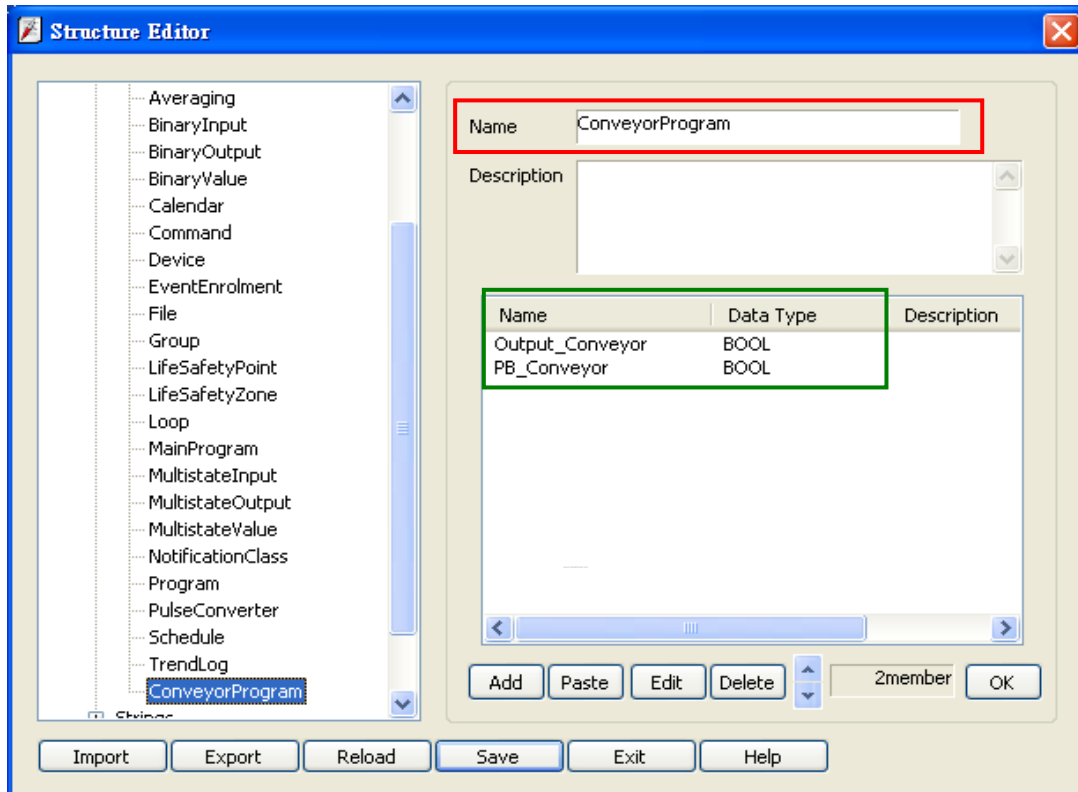

- In **[System Parameter Settings]**, click **[Import Tag]**, select the csv file. After importing a message window is displayed.

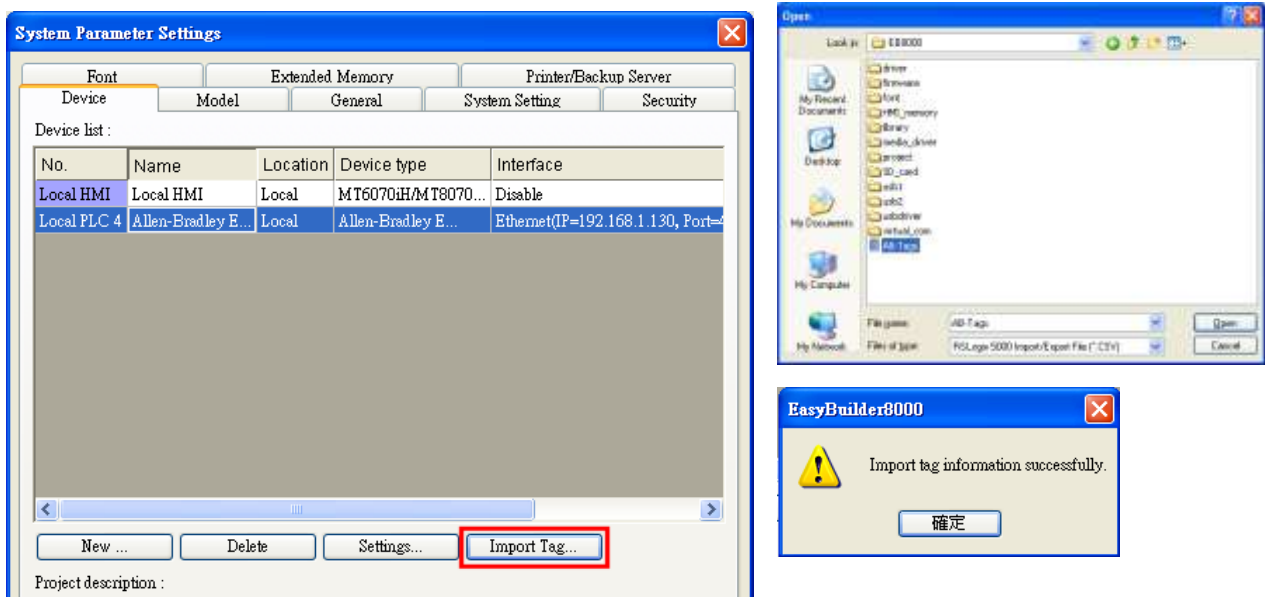

- In the object property dialog, select PLC Tag address.

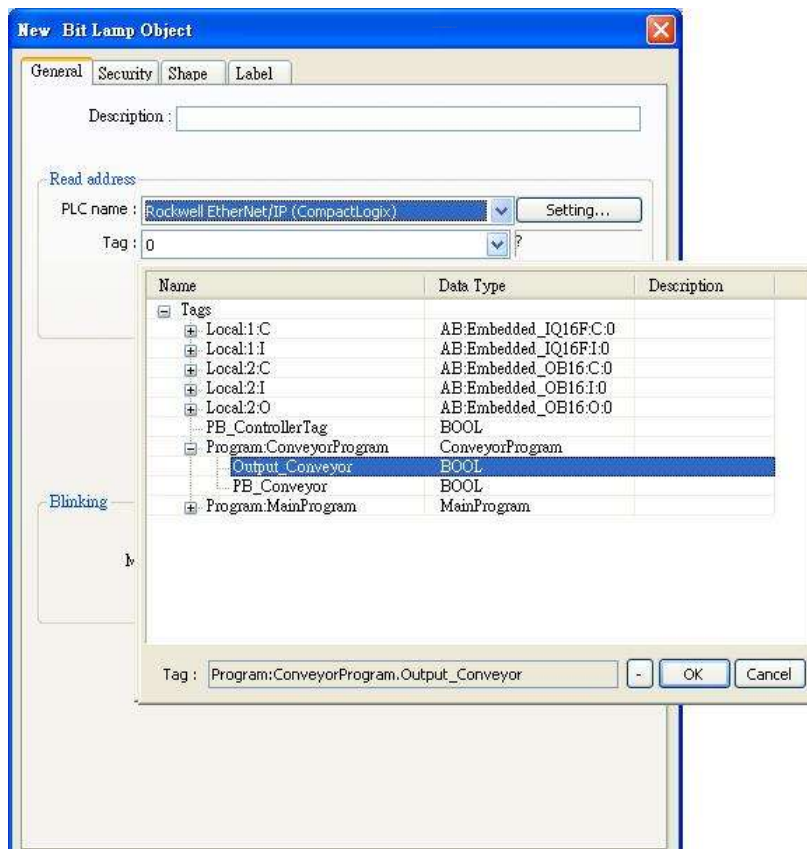



Device Address:

PLC Data Type Name	Bit/Word	EasyBuilder Data Format	Memo
BOOL	Boolean	Bit object	
BitArray			
SINT			
INT	Integer	16-bit signed, ASCII	-32768 ~ 32767
DINT	Double Integer	32-bit signed	$-2^{31} \sim (2^{31}-1)$
REAL	Single Precision Float	32-bit Float	IEEE 754





Wiring Diagram:

The following represents the view of HMI & PLC.



eMT3000 series

COM1 RS232 9P D-Sub Female	COM3 RS232 9P D-Sub Female		AB CPU CH0 RS232 9P D-Sub Female
2 RX	8 RX		3 TD
3 TX	7 TX		2 RD
5 GND	5 GND	—	5 GND
			

MT6000/8000 series except MT6050i/MT8050i

COM1 RS232 9P D-Sub Female	COM2 RS232 9P D-Sub Female	COM3 RS232 9P D-Sub Male	AB CPU CH0 RS232 9P D-Sub Female
2 RX	6 RX	8 RX	3 TD
3 TX	4 TX	7 TX	2 RD
5 GND	5 GND	5 GND	5 GND
			

MT6050i/MT8050i

COM1 RS232 9P D-Sub Female			AB CPU CH0 RS232 9P D-Sub Female
9 RX			3 TD
6 TX			2 RD
5 GND			5 GND
			

Driver Version:

Version	Date	Description
V1.00	June/2/2011	Driver released.

Rockwell CompactLogix/FlexLogix

Supported Series: Rockwell ControlLogix, CompactLogix, FlexLogix CH0 DF1.

Website: <http://www.ab.com>

HMI Setting:

Parameters	Recommended	Options	Notes
PLC type	Allen-Bradley CompactLogix/FlexLogix		
PLC I/F	RS232		
Baud rate	19200	9600, 19200, 38400	
Data bits	8	8	
Parity	None	Even, Odd, None	
Stop bits	1	1	
HMI sta. no.	0		
PLC sta. no.	1	1-31	

PLC Setting:

Communication mode	DF1 Full Duplex protocol 19200, None, 8, 1 (default) Error Check: BCC, Station Address: 1
--------------------	--

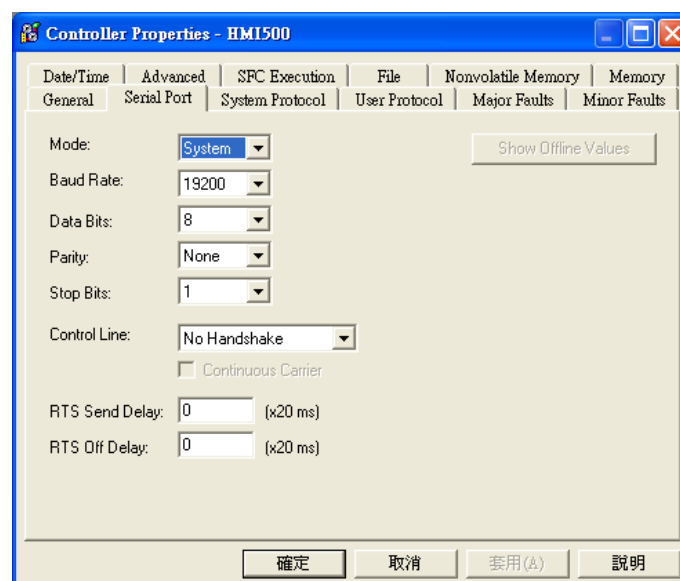

ControlLogix, CompactLogix CPU CH0 setting:

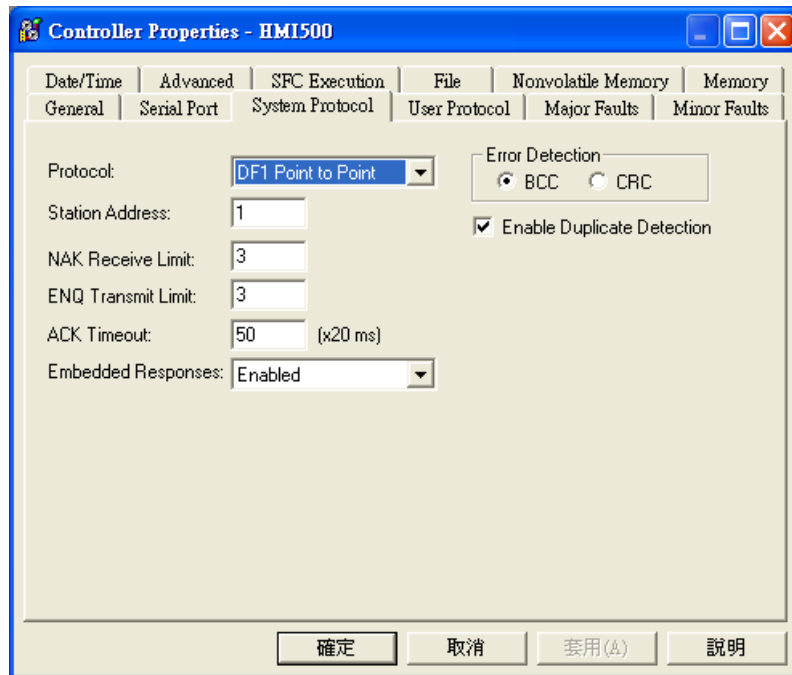

Create a Tag:

The name format must be 4 chars. For example: B003, T004, C005, N007, and F008.

Two or three chars are not available. For example: B03 or B3.

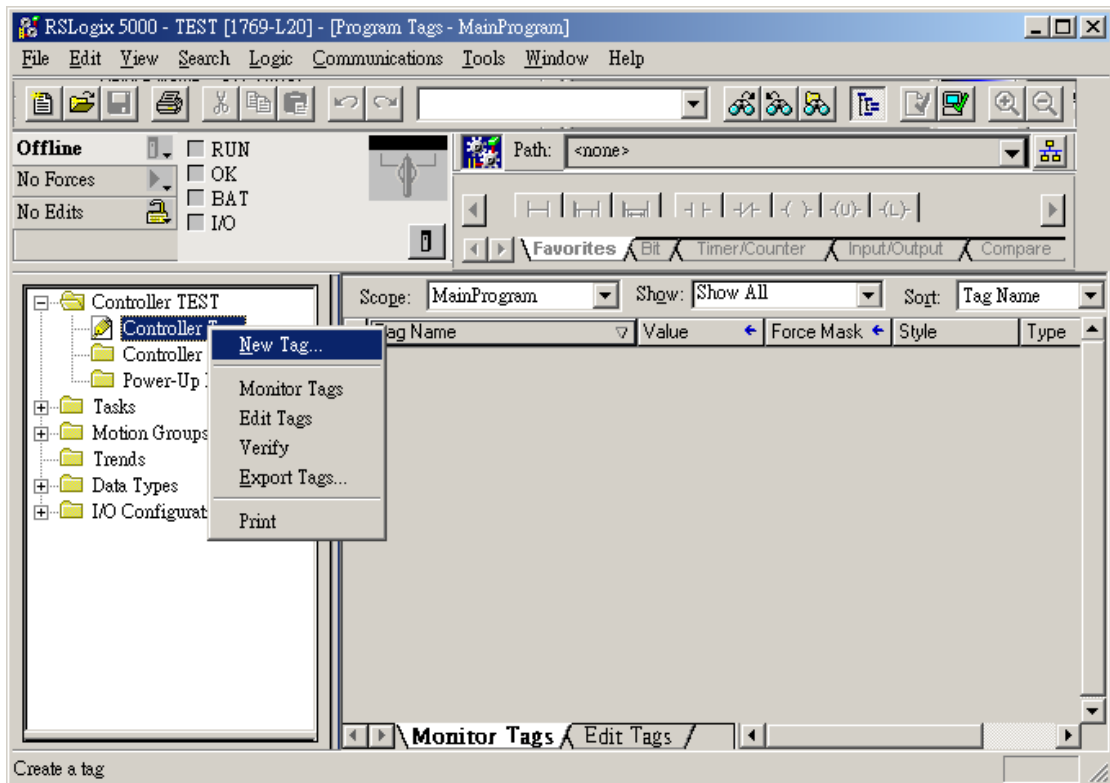

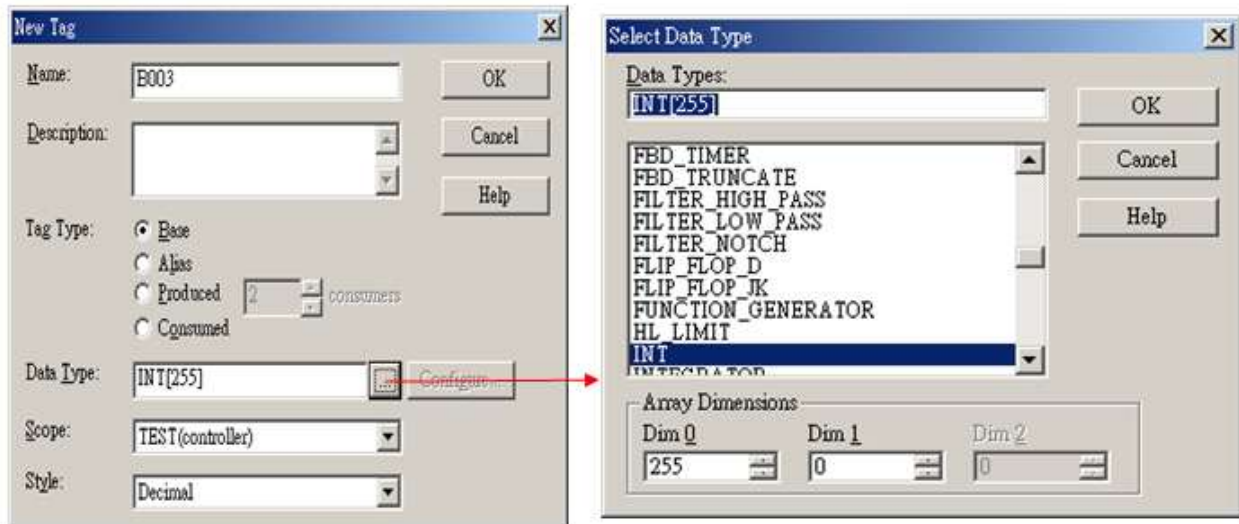



Device Address:

Bit/Word	Device type	Format	Range	Memo
B	B_BOOL	FFFDDDDdd	0 ~ 25525515	Bit data file
B	N_BOOL	FFFDDDDdd	0 ~ 25525515	Integer data file bit level (N7, 10 ~ 255)
DW	Tx.ACC	FFFDDD	0 ~ 255255	Timer Accumulator Value (T4, T10 ~ 255)
DW	Tx.PRE	FFFDDD	0 ~ 255255	Timer Preset Value (T4, T10 ~ 255)
DW	Nx_INT	FFFDDD	0 ~ 255255	Integer data file (N7, 10 ~ 255)
W	Bx_INT	FFFDDD	0 ~ 255255	Bit data file word level
DW	Cx.ACC	FFFDDD	0 ~ 255255	Counter Accumulator Value (C5, C10 ~ 255)
DW	Cx.PRE	FFFDDD	0 ~ 255255	Counter Preset Value (C5, C10 ~ 255)
W	F8_REAL	DDD	0 ~ 255	Floating point data file (F8)
W	Fx_REAL	FFFDDD	0 ~ 255255	Floating point data file (F008, F010 ~ F255)





Wiring Diagram:

The following represents the view of HMI & PLC.



eMT3000 series

COM1 RS232 9P D-Sub Female	COM3 RS232 9P D-Sub Female		AB CPU CH0 RS232 9P D-Sub Female
2 RX	8 RX		3 TD
3 TX	7 TX		2 RD
5 GND	5 GND		5 GND
			

MT6000/8000 series except MT6050i/MT8050i

COM1 RS232 9P D-Sub Female	COM2 RS232 9P D-Sub Female	COM3 RS232 9P D-Sub Male	AB CPU CH0 RS232 9P D-Sub Female
2 RX	6 RX	8 RX	3 TD
3 TX	4 TX	7 TX	2 RD
5 GND	5 GND	5 GND	5 GND
			

MT6050i/MT8050i

COM1 RS232 9P D-Sub Female			AB CPU CH0 RS232 9P D-Sub Female
9 RX			3 TD
6 TX			2 RD
5 GND			5 GND
			

Driver Version:

Version	Date	Description
V1.50	Dec/30/2008	

Rockwell DF1

Supported Series: Rockwell MicroLogix 1000, 1100, 1200, 1400, 1500, SLC 5/03, 5/04, 5/05.

Website: <http://www.ab.com>

Note: Allen-Bradley DF1 driver uses CRC checksum.

HMI Setting:

Parameters	Recommended	Options	Notes
PLC type	Allen-Bradley DF1		
PLC I/F	RS232		
Baud rate	9600	9600, 19200, 38400	
Data bits	8	8	
Parity	None	Even, Odd, None	
Stop bits	1	1	
HMI sta. no.	0		
PLC sta. no.	1	1-31	

PLC Setting:

Communication mode	DF1 Full Duplex protocol 19200, None, 8, 1 (default) Error Check: CRC
--------------------	--

Device Address:



Bit/Word	Device type	Format	Range	Memo
B	I1	DDDdd	0 ~ 25515	Input (I)
B	O0	DDDdd	0 ~ 25515	Output (O)
B	B3	DDDdd	0 ~ 25515	Bit data file (B3)
B	B10 ~ 13	DDDdd	0 ~ 25515	Bit data file (B10 ~ 13)
B	S_Bit	DDDdd	0 ~ 25515	Status (S) bit level
B	Bfn	FFFDDDdd	0 ~ 25525515	Bit data file (B3, 10 ~ 254)
B	NfnBit	FFFDDDdd	0 ~ 25525515	Integer data file bit level (N7, 10 ~ 254)
W	T4SV	DDD	0 ~ 255	Timer Preset Value (T4)
W	T4PV	DDD	0 ~ 255	Timer Accumulator Value (T4)

Bit/Word	Device type	Format	Range	Memo
W	C5SV	DDD	0 ~ 255	Counter Preset Value (C5)
W	C5PV	DDD	0 ~ 255	Counter Accumulator Value (C5)
W	TfnSV	FFFDDD	0 ~ 255255	Timer Preset Value
W	TfnPV	FFFDDD	0 ~ 255255	Timer Accumulator Value
W	CfnSV	FFFDDD	0 ~ 255255	Counter Preset Value
W	CfnPV	FFFDDD	0 ~ 255255	Counter Accumulator Value
W	N7	DDD	0 ~ 255	Integer data file (N7)
W	N10 ~ 15	DDD	0 ~ 255	Integer data file (N10 ~ 15)
W	Nfn	FFFDDD	0 ~ 255255	Integer data file (N7, 10 ~ 254)
W	S	DDD	0 ~ 255	Status (S)
W	F8	DDD	0 ~ 255	Floating point data file (F8)
W	Ffn	FFFDDD	0 ~ 255255	
W	Lfn	FFFDDD	0 ~ 255255	





Wiring Diagram:

The following represents the view of HMI & PLC.



9P D-Sub to 8P Mini-DIN: MicroLogix 1000, 1100, 1200, 1400, 1500
eMT3000 series

COM1 RS232 9P D-Sub Female	COM3 RS232 9P D-Sub Female		MicroLogix RS232 8P Mini-DIN Male
2 RX	8 RX		7 TXD
3 TX	7 TX		4 RXD
5 GND	5 GND		2 GND
			

MT6000/8000 series except MT6050i/MT8050i

COM1 RS232 9P D-Sub Female	COM2 RS232 9P D-Sub Female	COM3 RS232 9P D-Sub Male	MicroLogix RS232 8P Mini-DIN Male
2 RX	6 RX	8 RX	7 TXD
3 TX	4 TX	7 TX	4 RXD
5 GND	5 GND	5 GND	2 GND
			



MT6050i/MT8050i

COM1 RS232 9P D-Sub Female			MicroLogix RS232 8P Mini-DIN Male
9 RX			7 TXD
6 TX			4 RXD
5 GND			2 GND
			





The following represents the view of HMI & PLC.

9P D-Sub to 9P D-Sub: SLC5/03, 04, 05 CH0



eMT3000 series

COM1 RS232 9P D-Sub Female	COM3 RS232 9P D-Sub Female		AB CPU CH0 RS232 9P D-Sub Female
2 RX	8 RX		3 TD
3 TX	7 TX		2 RD
5 GND	5 GND		5 GND
			

MT6000/8000 series except MT6050i/MT8050i

COM1 RS232 9P D-Sub Female	COM2 RS232 9P D-Sub Female	COM3 RS232 9P D-Sub Male	AB CPU CH0 RS232 9P D-Sub Female
2 RX	6 RX	8 RX	3 TD
3 TX	4 TX	7 TX	2 RD
5 GND	5 GND	5 GND	5 GND
			

MT6050i/MT8050i

COM1 RS232 9P D-Sub Female			AB CPU CH0 RS232 9P D-Sub Female
9 RX			3 TD
6 TX			2 RD
5 GND			5 GND
			

Driver Version:

Version	Date	Description
V2.20	Jan/05/2010	

Rockwell DF1 (BCC)

Supported Series: Rockwell MicroLogix 1000, 1100, 1200, 1500, SLC 5/03, 5/04, 5/05.

Website: <http://www.ab.com>

Note: Allen-Bradley DF1 (BCC) and Allen-Bradley DF1 are the same; the only difference is the use of BCC checksum.

HMI Setting:

Parameters	Recommended	Options	Notes
PLC type	Allen-Bradley DF1 (BCC)		
PLC I/F	RS232		
Baud rate	19200	9600, 19200, 38400	
Data bits	8	8	
Parity	None	Even, Odd, None	
Stop bits	1	1	
HMI sta. no.	0		
PLC sta. no.	1	1-31	

PLC Setting:

Communication mode	DF1 Full Duplex protocol 19200, None, 8, 1 (default) Error Check: CRC
--------------------	--

Device Address:



Bit/Word	Device type	Format	Range	Memo
B	I1	DDDdd	0 ~ 25515	Input (I)
B	O0	DDDdd	0 ~ 25515	Output (O)
B	B3	DDDdd	0 ~ 25515	Bit data file (B3)
B	B10 ~ 13	DDDdd	0 ~ 25515	Bit data file (B10 ~ 13)
B	S_Bit	DDDdd	0 ~ 25515	Status (S) bit level
B	Bfn	FFFDDDdd	0 ~ 25525515	Bit data file (B3, 10 ~ 254)
B	NfnBit	FFFDDDdd	0 ~ 25525515	Integer data file bit level (N7, 10 ~ 254)
W	T4SV	DDD	0 ~ 255	Timer Preset Value (T4)
W	T4PV	DDD	0 ~ 255	Timer Accumulator Value (T4)

Bit/Word	Device type	Format	Range	Memo
W	C5SV	DDD	0 ~ 255	Counter Preset Value (C5)
W	C5PV	DDD	0 ~ 255	Counter Accumulator Value (C5)
W	TfnSV	FFFDDD	0 ~ 255255	Timer Preset Value
W	TfnPV	FFFDDD	0 ~ 255255	Timer Accumulator Value
W	CfnSV	FFFDDD	0 ~ 255255	Counter Preset Value
W	CfnPV	FFFDDD	0 ~ 255255	Counter Accumulator Value
W	N7	DDD	0 ~ 255	Integer data file (N7)
W	N10~15	DDD	0 ~ 255	Integer data file (N10 ~ 15)
W	Nfn	FFFDDD	0 ~ 255255	Integer data file (N7, 10 ~ 254)
W	S	DDD	0 ~ 255	Status (S)
W	F8	DDD	0 ~ 255	Floating point data file (F8)
W	Ffn	FFFDDD	0 ~ 255255	
W	Lfn	FFFDDD	0 ~ 255255	





Wiring Diagram:

The following represents the view of HMI & PLC.



9P D-Sub to 8P Mini-DIN: MicroLogix 1000, 1100, 1200, 1500
eMT3000 series

COM1 RS232 9P D-Sub Female	COM3 RS232 9P D-Sub Female		MicroLogix RS232 8P Mini-DIN Male
2 RX	8 RX		7 TXD
3 TX	7 TX		4 RXD
5 GND	5 GND		2 GND
			

MT6000/8000 series except MT6050i/MT8050i

COM1 RS232 9P D-Sub Female	COM2 RS232 9P D-Sub Female	COM3 RS232 9P D-Sub Male	MicroLogix RS232 8P Mini-DIN Male
2 RX	6 RX	8 RX	7 TXD
3 TX	4 TX	7 TX	4 RXD
5 GND	5 GND	5 GND	2 GND
			



MT6050i/MT8050i

COM1 RS232 9P D-Sub Female			MicroLogix RS232 8P Mini-DIN Male
9 RX			7 TXD
6 TX			4 RXD
5 GND			2 GND
			





The following represents the view of HMI & PLC.

9P D-Sub to 9P D-Sub: SLC5/03, 04, 05 CH0



eMT3000 series

COM1 RS232 9P D-Sub Female	COM3 RS232 9P D-Sub Female		AB CPU CH0 RS232 9P D-Sub Female
2 RX	8 RX		3 TD
3 TX	7 TX		2 RD
5 GND	5 GND		5 GND
			

MT6000/8000 series except MT6050i/MT8050i

COM1 RS232 9P D-Sub Female	COM2 RS232 9P D-Sub Female	COM3 RS232 9P D-Sub Male	AB CPU CH0 RS232 9P D-Sub Female
2 RX	6 RX	8 RX	3 TD
3 TX	4 TX	7 TX	2 RD
5 GND	5 GND	5 GND	5 GND
			

MT6050i/MT8050i

COM1 RS232 9P D-Sub Female			AB CPU CH0 RS232 9P D-Sub Female
9 RX			3 TD
6 TX			2 RD
5 GND			5 GND
			

Driver Version:

Version	Date	Description
V2.30	Apr/26/2010	

Rockwell DH485

Supported Series: Rockwell MicroLogix 1000, 1100, 1200, 1500, SLC 5/03, 5/04, 5/05.

Website: <http://www.ab.com>

HMI Setting:

Parameters	Recommended	Options	Notes
PLC type	Allen-Bradley DH485		
PLC I/F	RS485 2W	RS232	
Baud rate	19200	9600, 19200	
Data bits	8		
Parity	Even		
Stop bits	1		
HMI sta. no.	0	2	
PLC sta. no.	1	1-31	

Online simulation	YES
Extend address mode	NO

PLC Setting:

Communication mode	DH485 protocol 19200 (default) Set the Max. Node Address to the number of PLCs in use.
--------------------	---

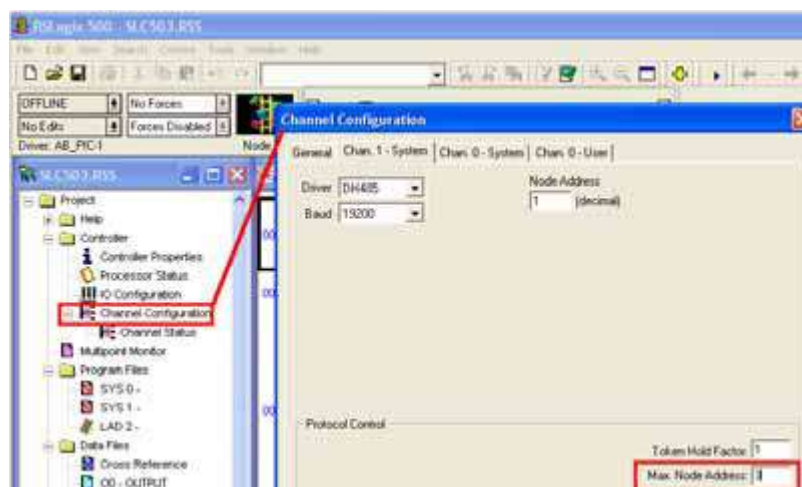

Device Address:

Bit/Word	Device type	Format	Range	Memo
B	I1	DDDdd	0 ~ 25515	Input (I)
B	O0	DDDdd	0 ~ 25515	Output (O)
B	B3	DDDdd	0 ~ 25515	Bit data file (B3)
B	B10 ~ 13	DDDdd	0 ~ 25515	Bit data file (B10 ~ 13)
B	Bfn	FFFDDDDdd	0 ~ 25525515	Bit data file (B3, 10 ~ 254)
B	NfnBit	FFFDDDDdd	0 ~ 25525515	Integer data file bit level (N7,10 ~ 254)
B	S_Bit	DDDdd	0 ~ 25515	Status file
W	T4SV	DDD	0 ~ 255	Timer Preset Value (T4)
W	T4PV	DDD	0 ~ 255	Timer Accumulator Value (T4)
W	C5SV	DDD	0 ~ 255	Counter Preset Value (C5)
W	C5PV	DDD	0 ~ 255	Counter Accumulator Value (C5)
W	TfnSV	FFFDDD	0 ~ 255255	Timer Preset Value
W	TfnPV	FFFDDD	0 ~ 255255	Timer Accumulator Value
W	CfnSV	FFFDDD	0 ~ 255255	Counter Preset Value
W	CfnPV	FFFDDD	0 ~ 255255	Counter Accumulator Value
W	F8	DDD	0 ~ 255	Floating point data file (F8)
W	N7	DDD	0 ~ 255	Integer data file (N7)
W	N10 ~ 15	DDD	0 ~ 255	Integer data file (N10 ~ 15)
W	Nfn	FFFDDD	0 ~ 255255	Integer data file (N7,10 ~ 254)
W	S	DDD	0 ~ 255	Status file



Wiring Diagram:

The following represents the view of HMI & PLC.



RS-485: SLC500 Fixed type, SLC5/01, 02, 03 CH1.

HMI can't connect to 1747-AIC peripheral port.



eMT3000 series

COM1 RS485 2W 9P D-Sub Male	COM3 RS485 2W 9P D-Sub Male		AB SLC500 DH485 RJ8 Male
1 RX-	6 Data-		2 SDB
2 RX+	9 Data+		1 SDA
5 GND	5 GND		7 GND
			

MT6000/8000 series except MT6050i/MT8050i



COM1 RS485 2W 9P D-Sub Male	COM3 RS485 2W 9P D-Sub Male		AB SLC500 DH485 RJ8 Male
1 RX-	6 Data-		2 SDB
2 RX+	9 Data+		1 SDA
5 GND	5 GND		7 GND
			

MT6050i/MT8050i





COM1 RS485 2W 9P D-Sub Female	COM3 RS485 2W 9P D-Sub Female		AB SLC500 DH485 RJ8 Male
1 RX-	7 Data-		2 SDB
2 RX+	8 Data+		1 SDA
5 GND	5 GND		7 GND
			

9P D-Sub to 8P Mini-DIN: MicroLogix 1000, 1100, 1200, and 1500 must set DH485 protocol.



eMT3000 series

COM1 RS232 9P D-Sub Female	COM3 RS232 9P D-Sub Female		MicroLogix RS232 8P Mini-DIN Male
2 RX	8 RX		7 TXD
3 TX	7 TX		4 RXD
5 GND	5 GND		2 GND
			

MT6000/8000 series except MT6050i/MT8050i



COM1 RS232 9P D-Sub Female	COM2 RS232 9P D-Sub Female	COM3 RS232 9P D-Sub Male	MicroLogix RS232 8P Mini-DIN Male
2 RX	6 RX	8 RX	7 TXD
3 TX	4 TX	7 TX	4 RXD
5 GND	5 GND	5 GND	2 GND
			

MT6050i/MT8050i





COM1 RS232 9P D-Sub Female			MicroLogix RS232 8P Mini-DIN Male
9 RX			7 TXD
6 TX			4 RXD
5 GND			2 GND
			

9P D-Sub to 9P D-Sub: SLC5/03, 04, 05 CH0 must set DH485 protocol.



eMT3000 series

COM1 RS232 9P D-Sub Female	COM3 RS232 9P D-Sub Female		AB CPU CH0 RS232 9P D-Sub Female
2 RX	8 RX		3 TD
3 TX	7 TX		2 RD
5 GND	5 GND		5 GND
			

MT6000/8000 series except MT6050i/MT8050i

COM1 RS232 9P D-Sub Female	COM2 RS232 9P D-Sub Female	COM3 RS232 9P D-Sub Male	AB CPU CH0 RS232 9P D-Sub Female
2 RX	6 RX	8 RX	3 TD
3 TX	4 TX	7 TX	2 RD
5 GND	5 GND	5 GND	5 GND
			

MT6050i/MT8050i

COM1 RS232 9P D-Sub Female			AB CPU CH0 RS232 9P D-Sub Female
9 RX			3 TD
6 TX			2 RD
5 GND			5 GND
			

Driver Version:

Version	Date	Description
V1.20	Apr/17/2009	

Rockwell EtherNet/IP (CompactLogix)

Supported Series: Rockwell ControlLogix, CompactLogix, FlexLogix Ethernet.

Website: <http://www.ab.com>

HMI Setting:

Parameters	Recommended	Options	Notes
PLC type	Allen-Bradley EtherNet/IP (CompactLogix)		
PLC I/F	Ethernet		
Port no.	44818		
PLC sta. no.	1		

PLC Setting:

RSLogix 5000 setting

Create a Tag:

The name format must be 4 chars. For example: B003, T004, C005, N007, and F008.

Two or three chars are not available. For example: B03 or B3.

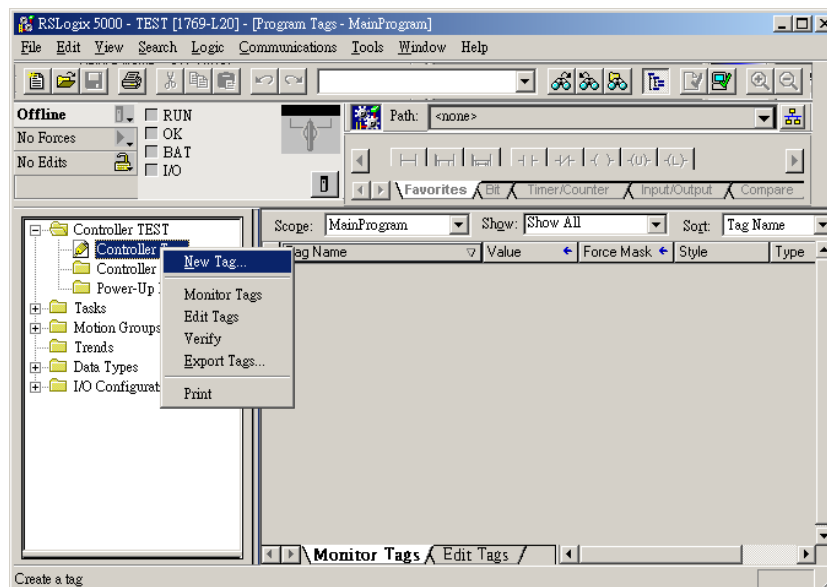

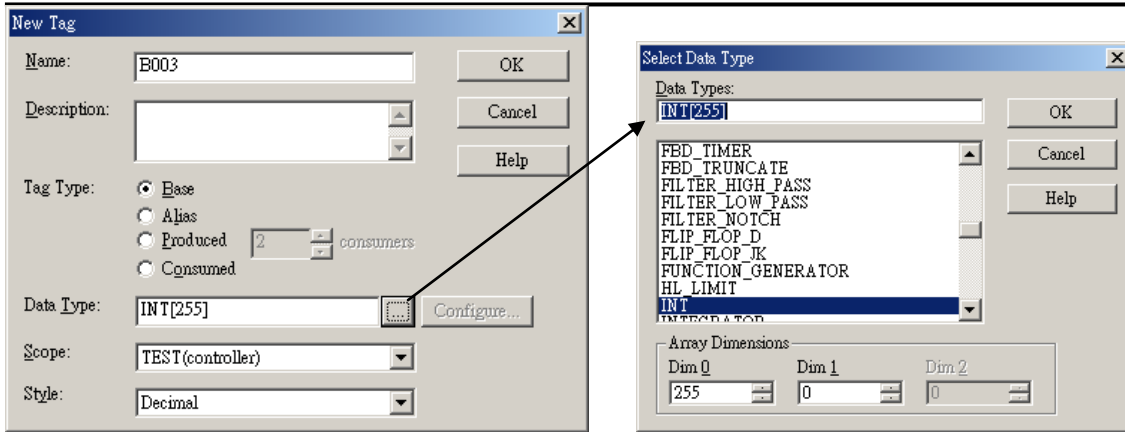

Device Address:

Bit/Word	Device type	Format	Range	Memo
B	Bx_BOOL	FFFDDDD	0 ~ 25525515	Bit data file
B	Nx_BOOL	FFFDDDD	0 ~ 25525515	Integer data file bit level (N7, 10 ~ 99)
W	Bx_INT	FFFDDD	0 ~ 255255	Bit data file word level
W	Nx_INT	FFFDDD	0 ~ 255255	Integer data file (N7, 10 ~ 99)
DW (F)	F8_REAL	DDD	0 ~ 255	Floating point data file (F8)
DW (F)	Fx_REAL	FFFDDD	0 ~ 255255	Floating point data file (F8)
DW	Cx.ACC	FFFDDD	0 ~ 255255	Counter Accumulator Value (C5, C10 ~ 255)
DW	Cx.PRE	FFFDDD	0 ~ 255255	Counter Preset Value (C5, C10 ~ 255)
DW	Tx.ACC	FFFDDD	0 ~ 255255	Timer Accumulator Value (T4, T10 ~ 255)
DW	Tx.PRE	FFFDDD	0 ~ 255255	Timer Preset Value (T4, T10 ~ 255)
DW	Lx.DINT	FFFDDD	0 ~ 255255	

Wiring Diagram:

Direct connect (crossover cable):

HMI RJ45 Male	Wire Color	Wire Color	PLC RJ45 Male
1 TX+	White/Orange	White/Green	3 RX+
2 TX-	Orange	Green	6 RX-
3 RX+	White/Green	White/Orange	1 TX+
4 BD4+	Blue	Blue	4 BD4+
5 BD4-	White/Blue	White/Blue	5 BD4-
6 RX-	Green	Orange	2 TX-
7 BD3+	White/Brown	White/Brown	7 BD3+
8 BD3-	Brown	Brown	8 BD3-



Through a hub:

HMI RJ45 Male	Wire Color	Wire Color	PLC RJ45 Male
1 TX+	White/Orange	White/Orange	1 TX+
2 TX-	Orange	Orange	2 TX-
3 RX+	White/Green	White/Green	3 RX+
4 BD4+	Blue	Blue	4 BD4+
5 BD4-	White/Blue	White/Blue	5 BD4-
6 RX-	Green	Green	6 RX-
7 BD3+	White/Brown	White/Brown	7 BD3+
8 BD3-	Brown	Brown	8 BD3-



Driver Version:

Version	Date	Description
V1.30	Dec/30/2008	
V1.50	Mar/6/2012	Added register: Lx.DINT

Rockwell EtherNet/IP (CompactLogix) – Free Tag Names

Supported Series: Rockwell CompactLogix, FlexLogix Ethernet

Website: <http://www.ab.com>

HMI Setting:

Parameters	Recommended	Options	Notes
PLC type	Allen-Bradley EtherNet/IP (CompactLogix) – Free Tag Names		
PLC I/F	Ethernet		
Port no.	44818		
PLC sta. no.	1		

PLC Setting:

1. Set PLC IP address.

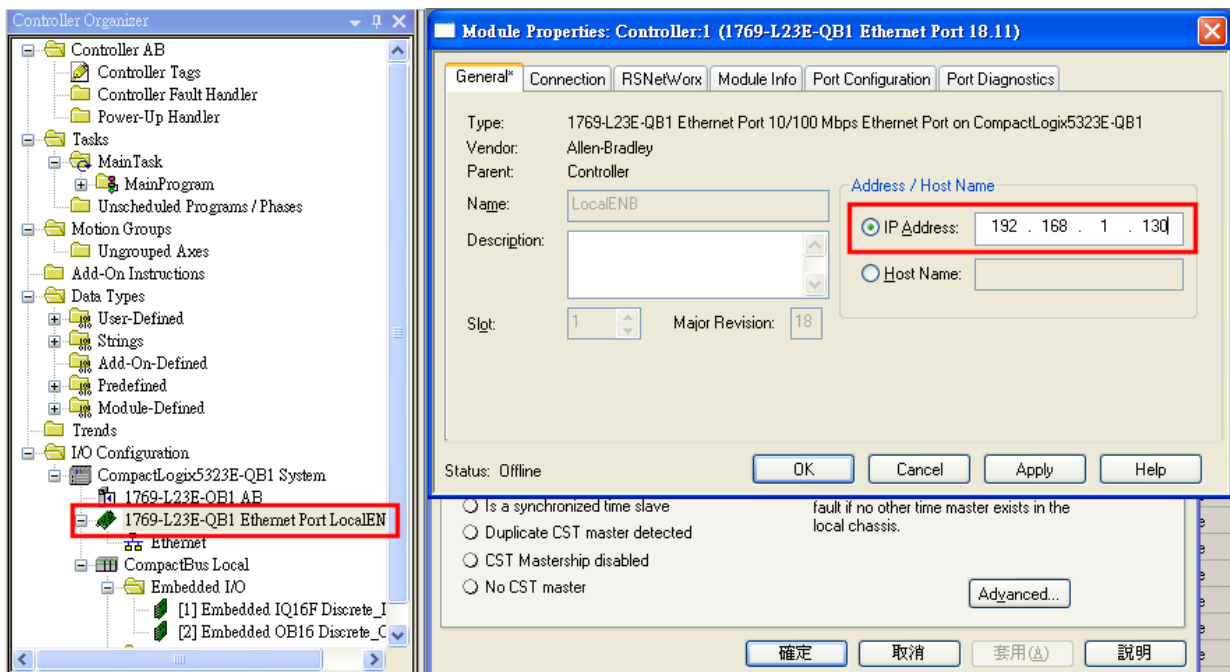

2. Create new tags (Controller Tags and Program Tags supported).

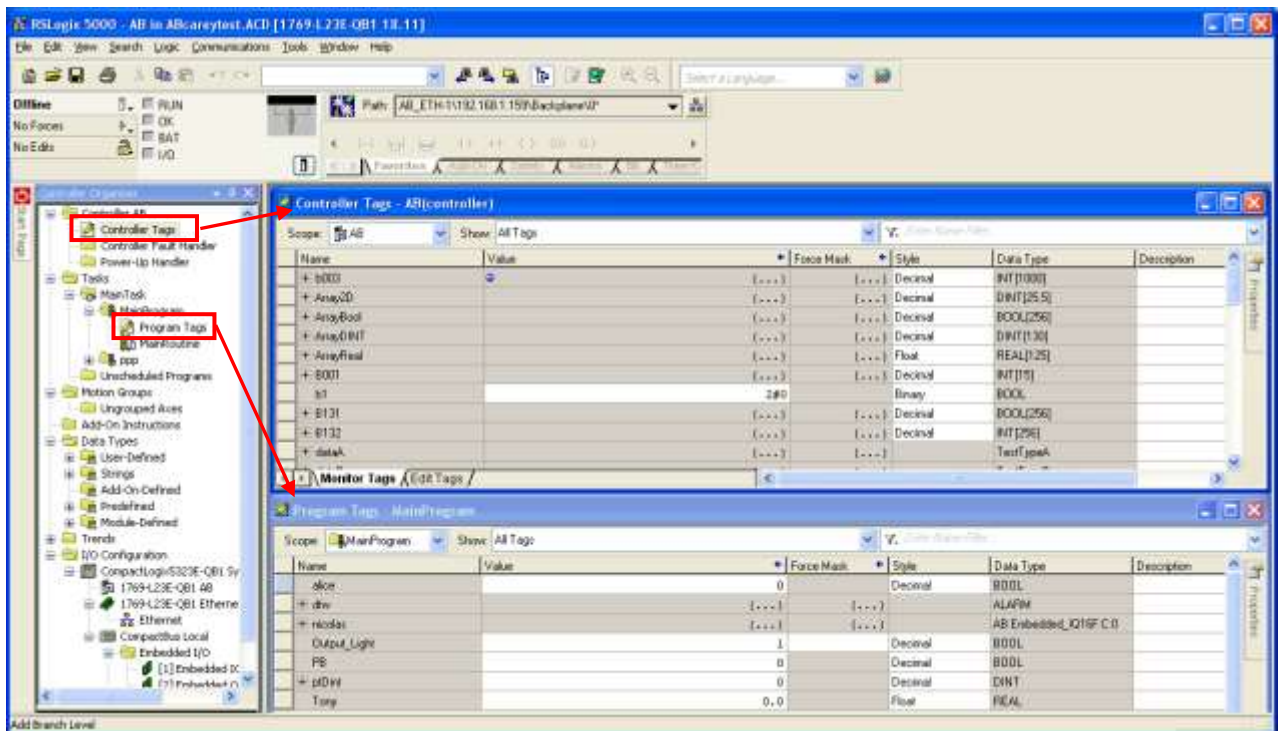

3. Export Tag data to CSV file. ([Tools] » [Export] » [Tags and Logic Comments])

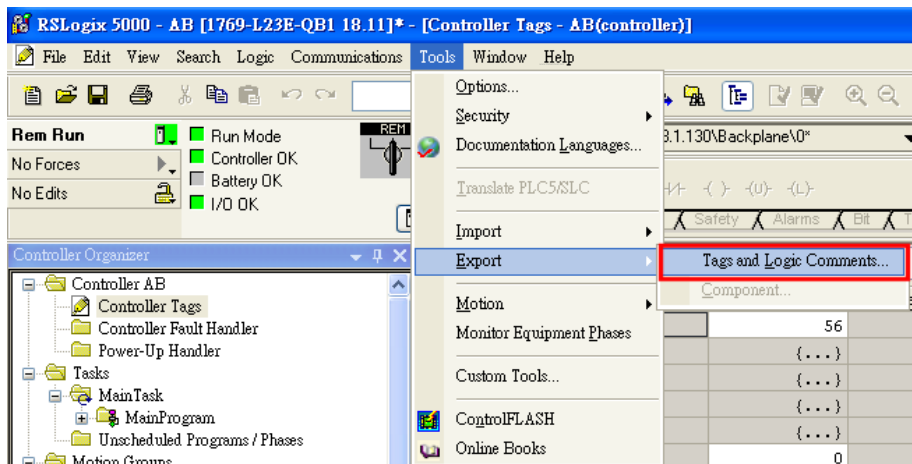

Note: The separator character in CSV file must be a comma “,” otherwise the file is invalid.

TAG	Array2D		DINT[25,5]	(RADIX := Decimal, Constant := false, ExternalAccess := Read/Write)
TAG	ArrayBool		BOOL[256]	(RADIX := Decimal, Constant := false, ExternalAccess := Read/Write)
TAG	ArrayDINT		DINT[130]	(RADIX := Decimal, Constant := false, ExternalAccess := Read/Write)

The directory of changing system settings: [Control Panel] » [Date, Time, Language, and Regional Options] » [Change the format of numbers, dates, and times] » [Customize] » [List separator]. Please select “,” and export CSV file after setting.

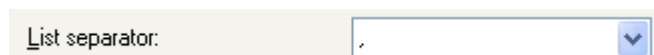

- Open EasyBuilder project file, select the driver and set IP address. Click **[Data Type]** to open **[Structure Editor]** and edit the data type of the tags.

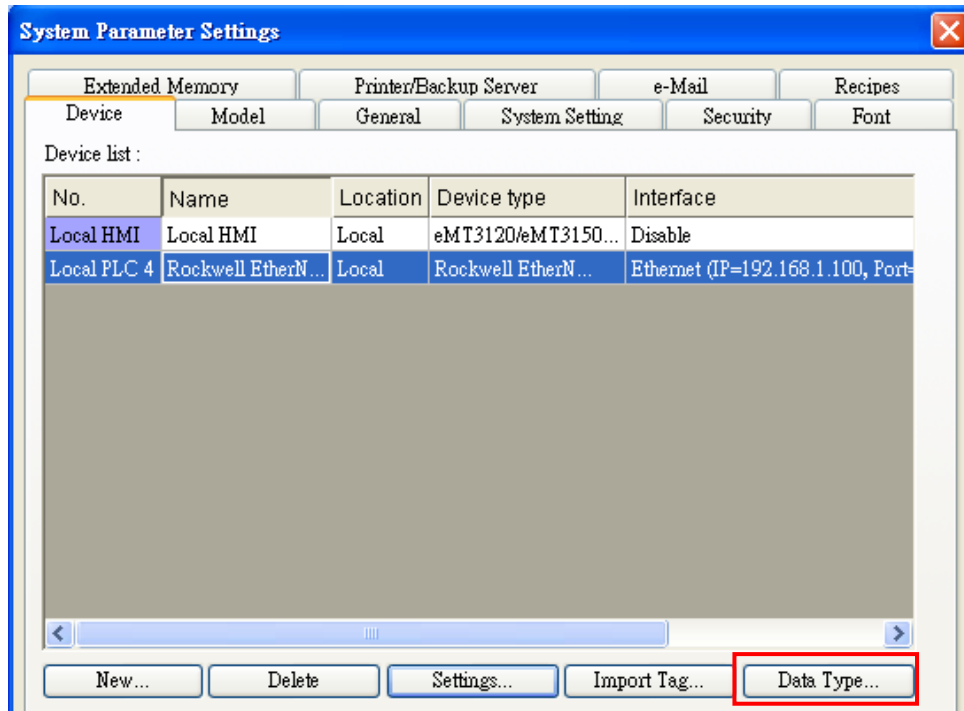

TYPE	SCOPE	NAME	DESCRIPTION	DATATYPE	SPECIFIER	ATTRIBUTES
TAG		Local:1:C		AB:Embedded_IQ16F:C:0		
TAG		Local:1:I		AB:Embedded_IQ16F:I:0		
TAG		Local:2:C		AB:Embedded_OB16:C:0		
TAG		Local:2:I		AB:Embedded_OB16:I:0		
TAG		Local:2:O		AB:Embedded_OB16:O:0		

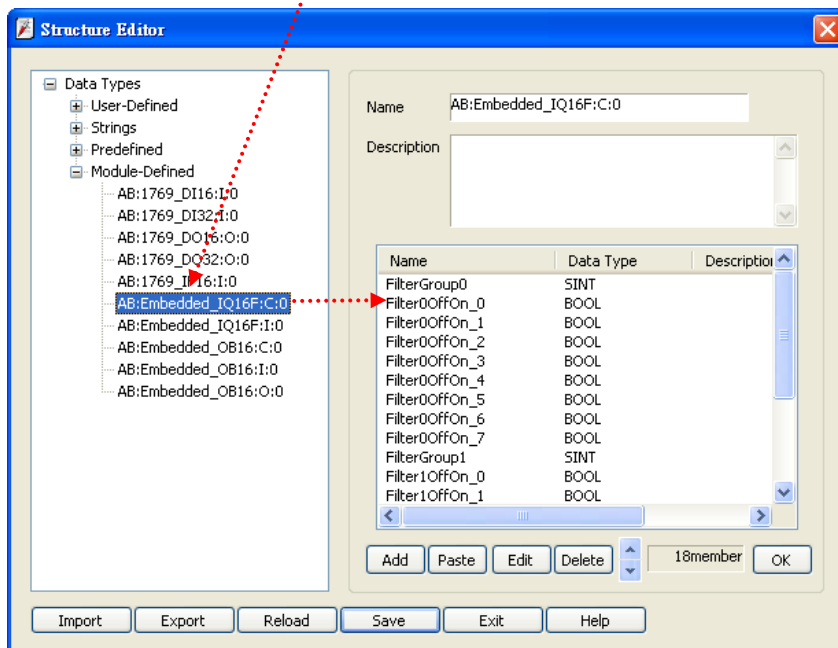

5. In **[Structure Editor]** edit the data type of **[Program Tag]**.

The imported csv file is shown below:

7	TYPE	SCOPE	NAME	DESCRIPTION	DATATYPE	SPECIFIER
8	TAG		Local:1:C		AB:Embedded_IQ16F:C:0	
9	TAG		Local:1:I		AB:Embedded_IQ16F:I:0	
10	TAG		Local:2:C		AB:Embedded_OB16:C:0	
11	TAG		Local:2:I		AB:Embedded_OB16:I:0	
12	TAG		Local:2:O		AB:Embedded_OB16:O:0	
13	TAG		PB_ControllerTag		BOOL	
14	TYPE	SCOPE	NAME	DESCRIPTION	DATATYPE	SPECIFIER
15	TAG	ConveyorProgram	Output_Conveyor			Local:2:O,Data.2
16	TAG	ConveyorProgram	PB_Conveyor		BOOL	
17	TYPE	SCOPE	NAME	DESCRIPTION	DATATYPE	SPECIFIER
18	TAG	MainProgram	Output_Light			Local:2:O,Data.1
19	TAG	MainProgram	PB		BOOL	

Step 1

Right click on **[Structure Editor]** » **[User-Defined]** to add a **[new data type]**.

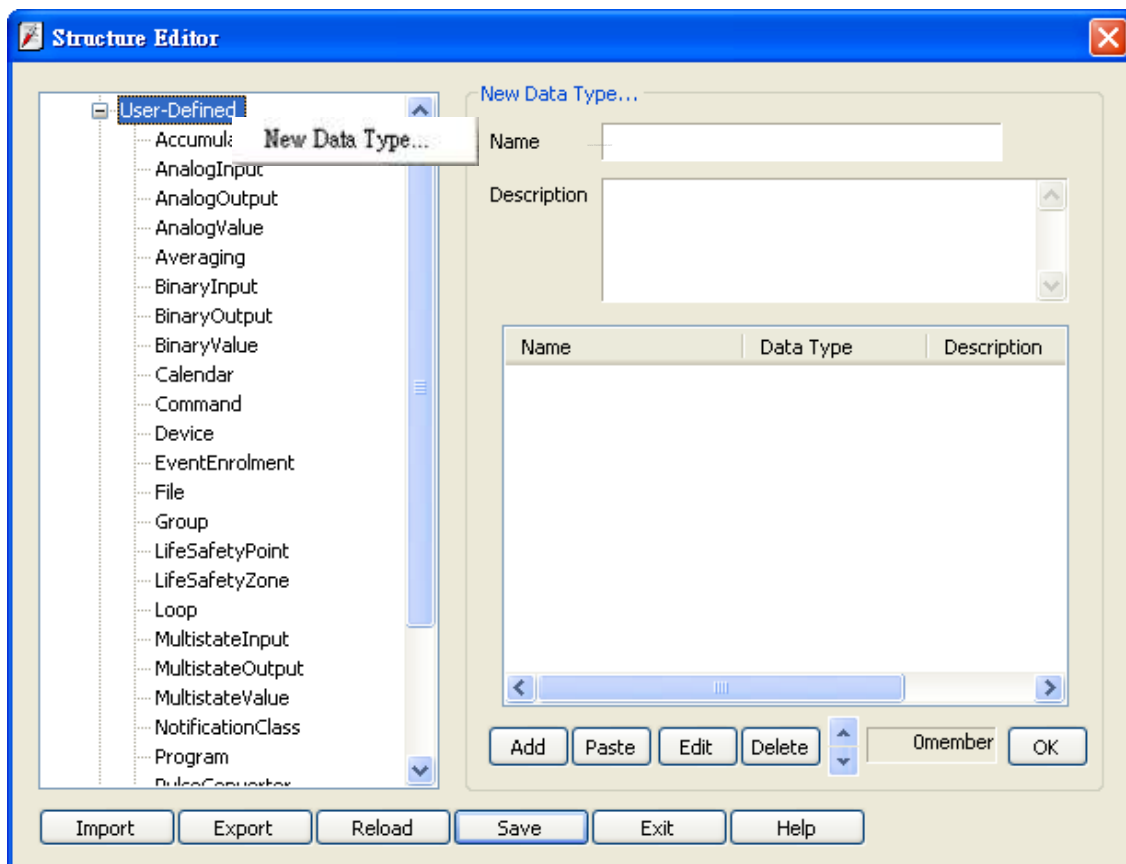

Step 2

After adding all Program Tags, click **[OK]** » **[Save]** » **[Exit]** to leave the editor dialog.

TYPE	SCOPE	NAME	DESCRIPTION	DATATYPE	SPECIFIER
ALIAS	ConveyorProgram	Output_Conveyor			Local:2:O.Data.2
TAG	ConveyorProgram	PB_Conveyor		BOOL	
TYPE	SCOPE	NAME	DESCRIPTION	DATATYPE	SPECIFIER
ALIAS	MainProgram	Output_Light			Local:2:O.Data.1
TAG	MainProgram	PB		BOOL	

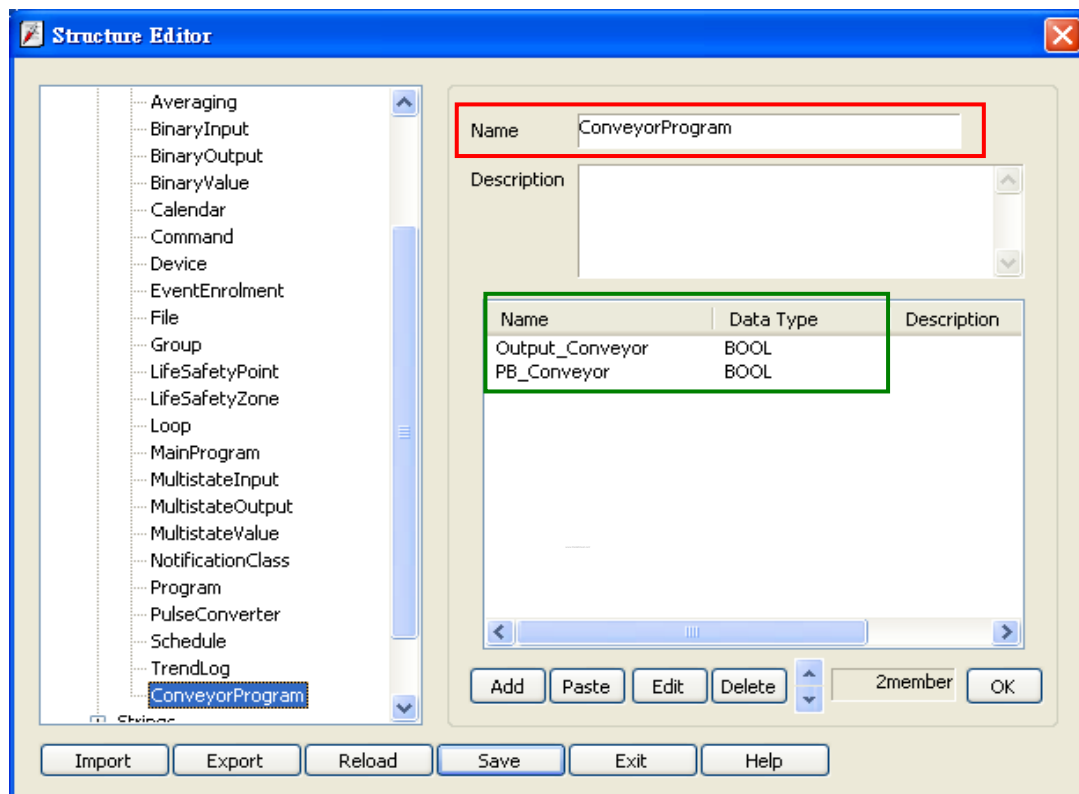

- In **[System Parameter Settings]**, click **[Import Tag]**, select the csv file. After importing a message window is displayed.

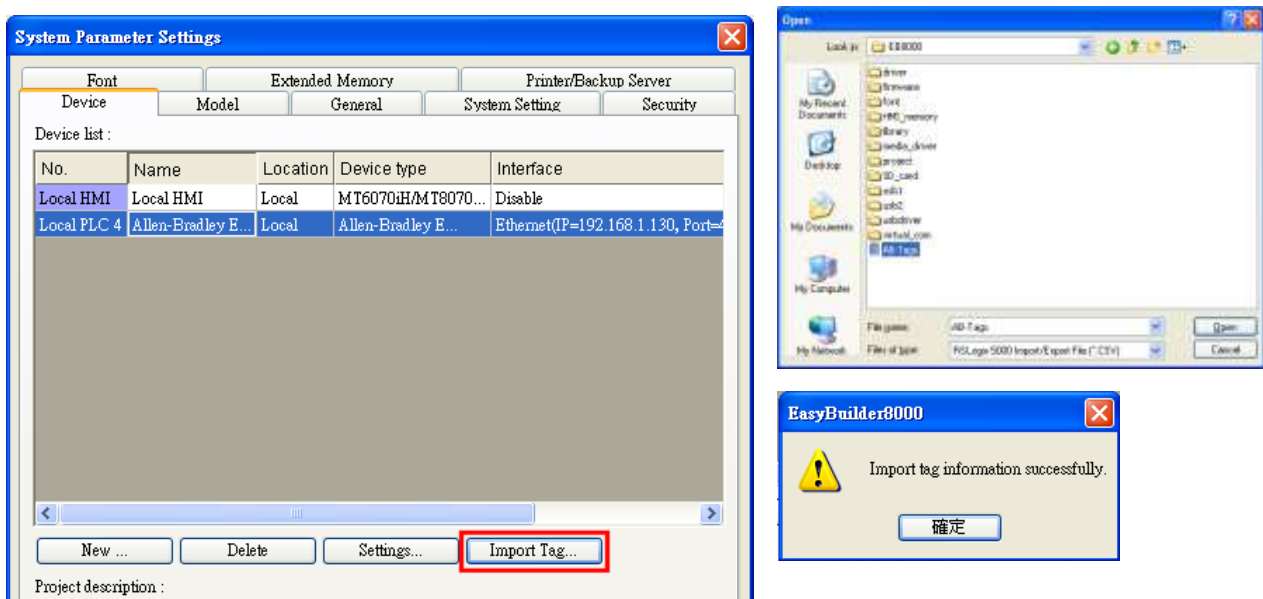

- In the object property dialog, select PLC Tag address.

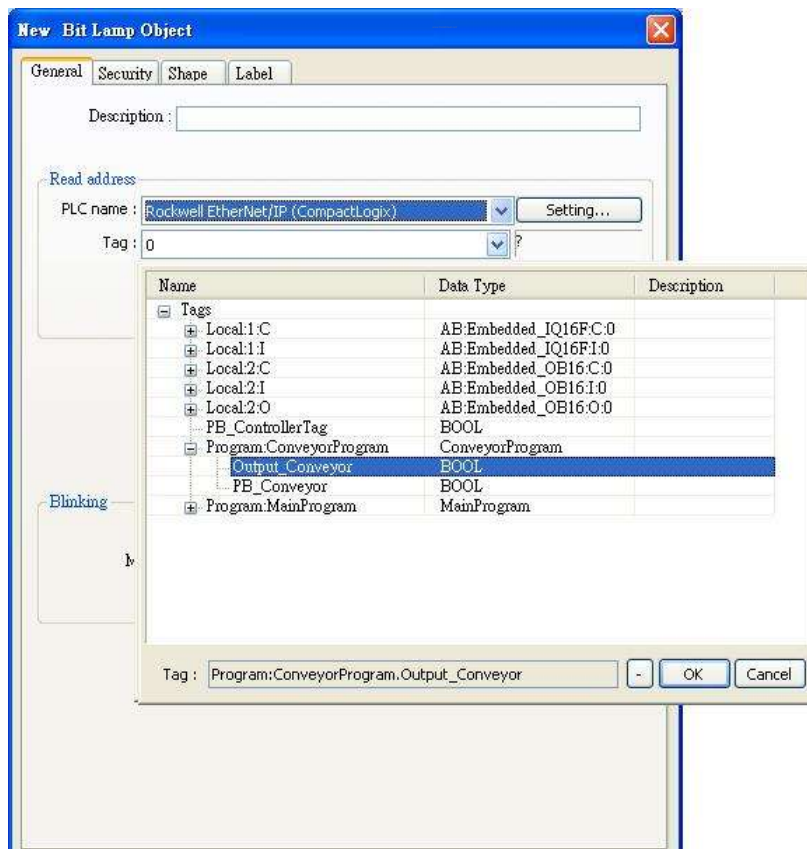

Device Address:

PLC data type name	Bit/Word	EasyBuilder data format	Memo
BOOL	Boolean	Bit object	
BitArray			
SINT			
INT	Integer	16-bit signed, ASCII	-32768 ~ 32767
DINT	Double Integer	32-bit signed	$-2^{31} \sim (2^{31}-1)$
REAL	Single Precision Float	32-bit Float	IEEE 754

Wiring Diagram:

Direct connect (crossover cable):

HMI RJ45 Male	Wire Color	Wire Color	PLC RJ45 Male
1 TX+	White/Orange	White/Green	3 RX+
2 TX-	Orange	Green	6 RX-
3 RX+	White/Green	White/Orange	1 TX+
4 BD4+	Blue	Blue	4 BD4+
5 BD4-	White/Blue	White/Blue	5 BD4-
6 RX-	Green	Orange	2 TX-
7 BD3+	White/Brown	White/Brown	7 BD3+
8 BD3-	Brown	Brown	8 BD3-



Through a hub:

HMI RJ45 Male	Wire Color	Wire Color	PLC RJ45 Male
1 TX+	White/Orange	White/Orange	1 TX+
2 TX-	Orange	Orange	2 TX-
3 RX+	White/Green	White/Green	3 RX+
4 BD4+	Blue	Blue	4 BD4+
5 BD4-	White/Blue	White/Blue	5 BD4-
6 RX-	Green	Green	6 RX-
7 BD3+	White/Brown	White/Brown	7 BD3+
8 BD3-	Brown	Brown	8 BD3-



Driver Version:

Version	Date	Description
V1.10	Aug/25/2010	

Rockwell EtherNet/IP (ControlLogix) – Free Tag Names

Supported Series: Rockwell ControlLogix, CompactLogix, FlexLogix Ethernet.

Website: <http://www.ab.com>

HMI Setting:

Parameters	Recommended	Options	Notes
PLC type	Allen-Bradley EtherNet/IP (ControlLogix) – Free Tag Names		
PLC I/F	Ethernet		
Port no.	44818		
PLC sta. no.	The same as CPU Slot No.		

PLC Setting:

1. Set PLC IP address.

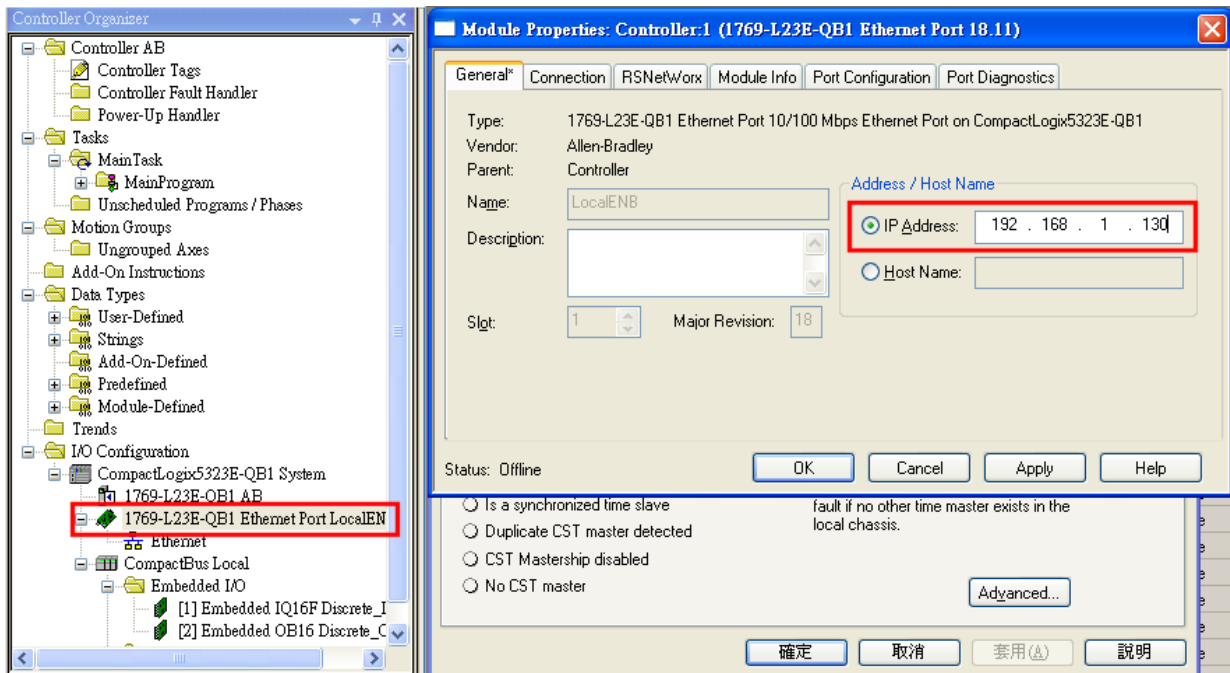

2. Create new tags (Controller Tags and Program Tags supported).

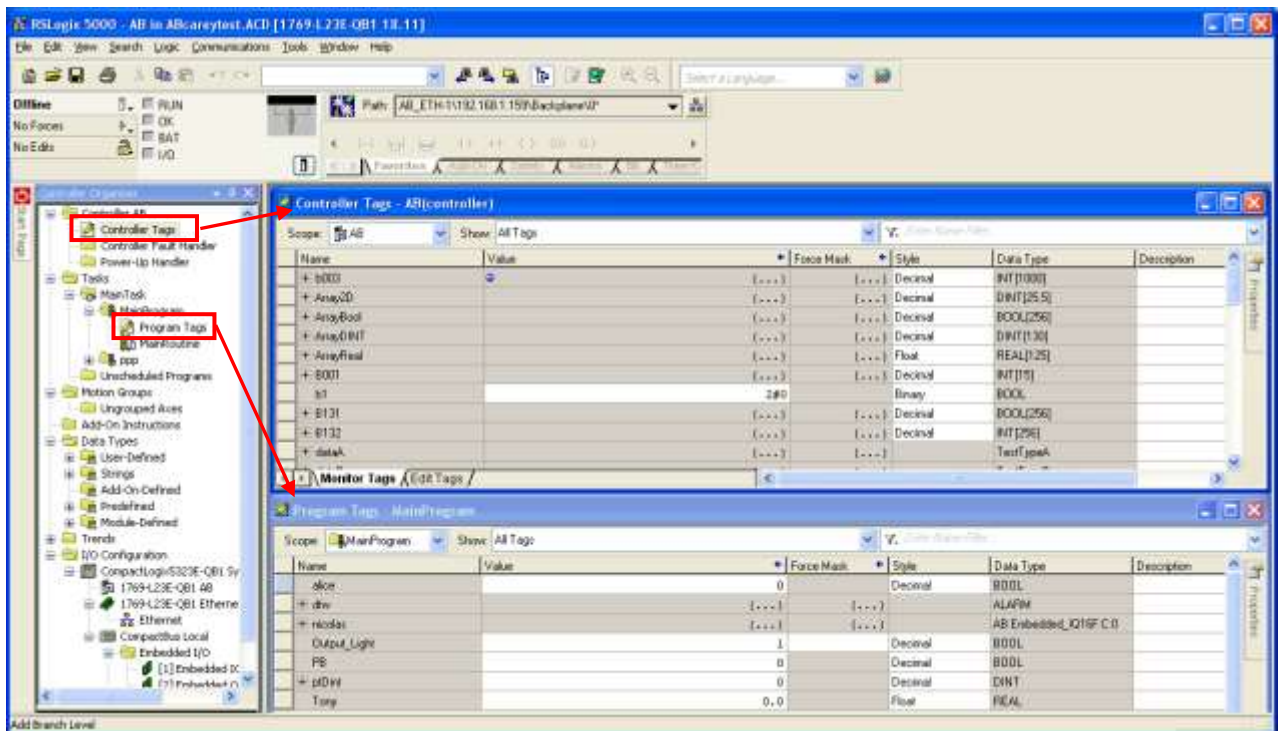

3. Export Tag data to CSV file. ([Tools] » [Export] » [Tags and Logic Comments])

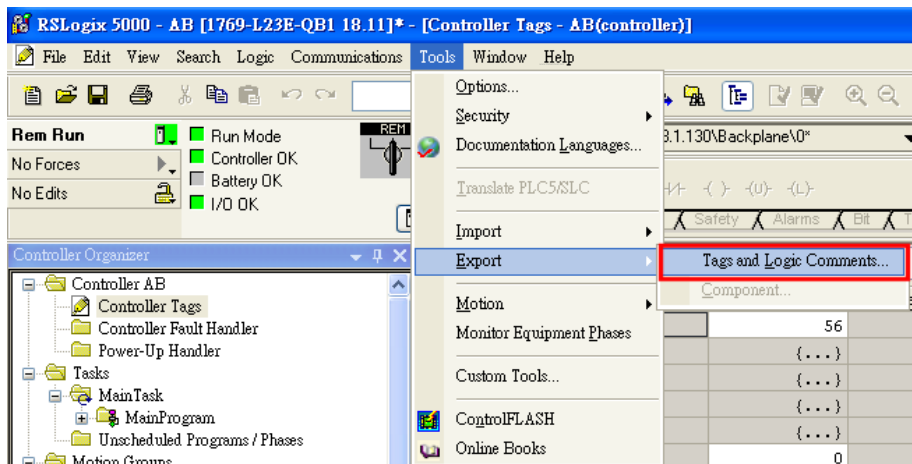

Note: The separator character in CSV file must be a comma “,” otherwise the file is invalid.

TAG	Array2D	DINT[25,5]	(RADIX := Decimal, Constant := false, ExternalAccess := Read/Write)
TAG	ArrayBool	BOOL[256]	(RADIX := Decimal, Constant := false, ExternalAccess := Read/Write)
TAG	ArrayDINT	DINT[130]	(RADIX := Decimal, Constant := false, ExternalAccess := Read/Write)

The directory of changing system settings: [Control Panel] » [Date, Time, Language, and Regional Options] » [Change the format of numbers, dates, and times] » [Customize] » [List separator]. Please select “,” and export CSV file after setting.

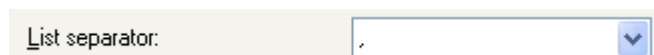

- Open EasyBuilder project file, select the driver and set IP address. Click **[Data Type]** to open **[Structure Editor]** and edit the data type of the tags.

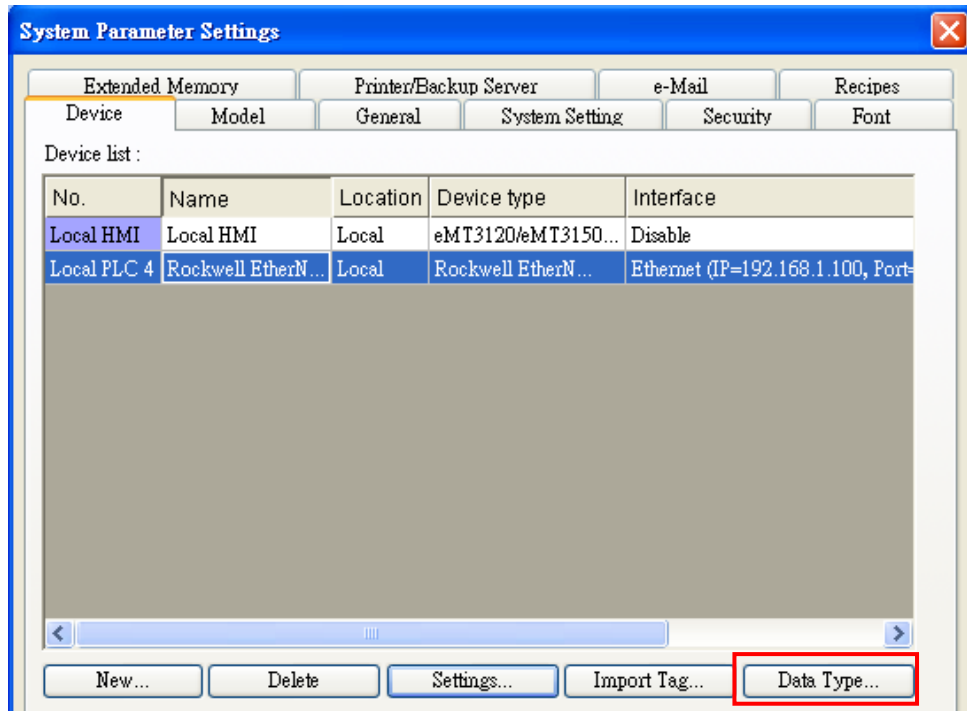

TYPE	SCOPE	NAME	DESCRIPTION	DATATYPE	SPECIFIER	ATTRIBUTES
TAG		Local:1:C		AB:Embedded_IQ16F:C:0		
TAG		Local:1:I		AB:Embedded_IQ16F:I:0		
TAG		Local:2:C		AB:Embedded_OB16:C:0		
TAG		Local:2:I		AB:Embedded_OB16:I:0		
TAG		Local:2:O		AB:Embedded_OB16:O:0		

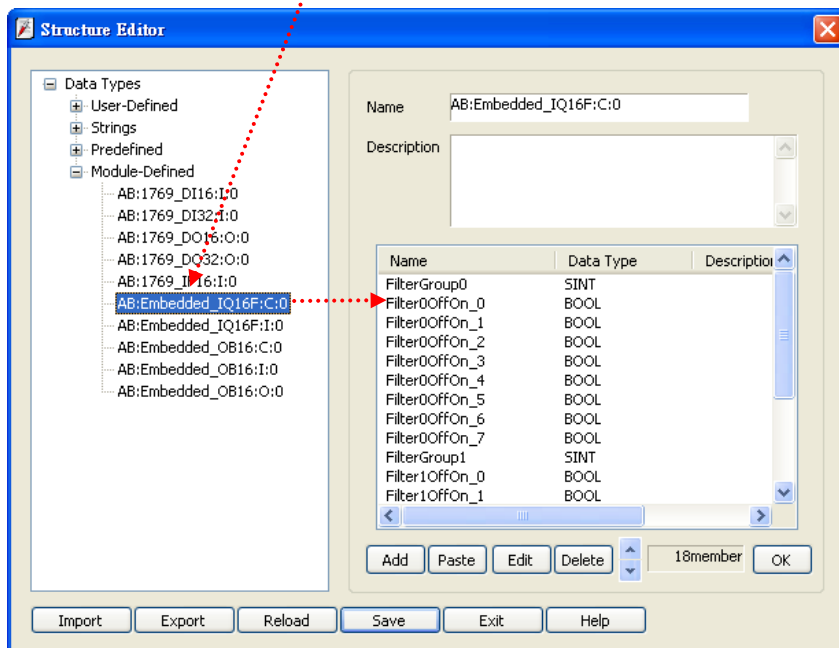

5. In **[Structure Editor]** edit the data type of **[Program Tag]**.

The imported csv file is shown below:

7	TYPE	SCOPE	NAME	DESCRIPTION	DATATYPE	SPECIFIER
8	TAG		Local:1:C		AB:Embedded_IQ16F:C:0	
9	TAG		Local:1:I		AB:Embedded_IQ16F:I:0	
10	TAG		Local:2:C		AB:Embedded_OB16:C:0	
11	TAG		Local:2:I		AB:Embedded_OB16:I:0	
12	TAG		Local:2:O		AB:Embedded_OB16:O:0	
13	TAG		PB_ControllerTag		BOOL	
14	TYPE	SCOPE	NAME	DESCRIPTION	DATATYPE	SPECIFIER
15	TAG	ConveyorProgram	Output_Conveyor			Local:2:O,Data.2
16	TAG	ConveyorProgram	PB_Conveyor		BOOL	
17	TYPE	SCOPE	NAME	DESCRIPTION	DATATYPE	SPECIFIER
18	TAG	MainProgram	Output_Light			Local:2:O,Data.1
19	TAG	MainProgram	PB		BOOL	

Step 1

Right click on **[Structure Editor]** » **[User-Defined]** to add a **[new data type]**.

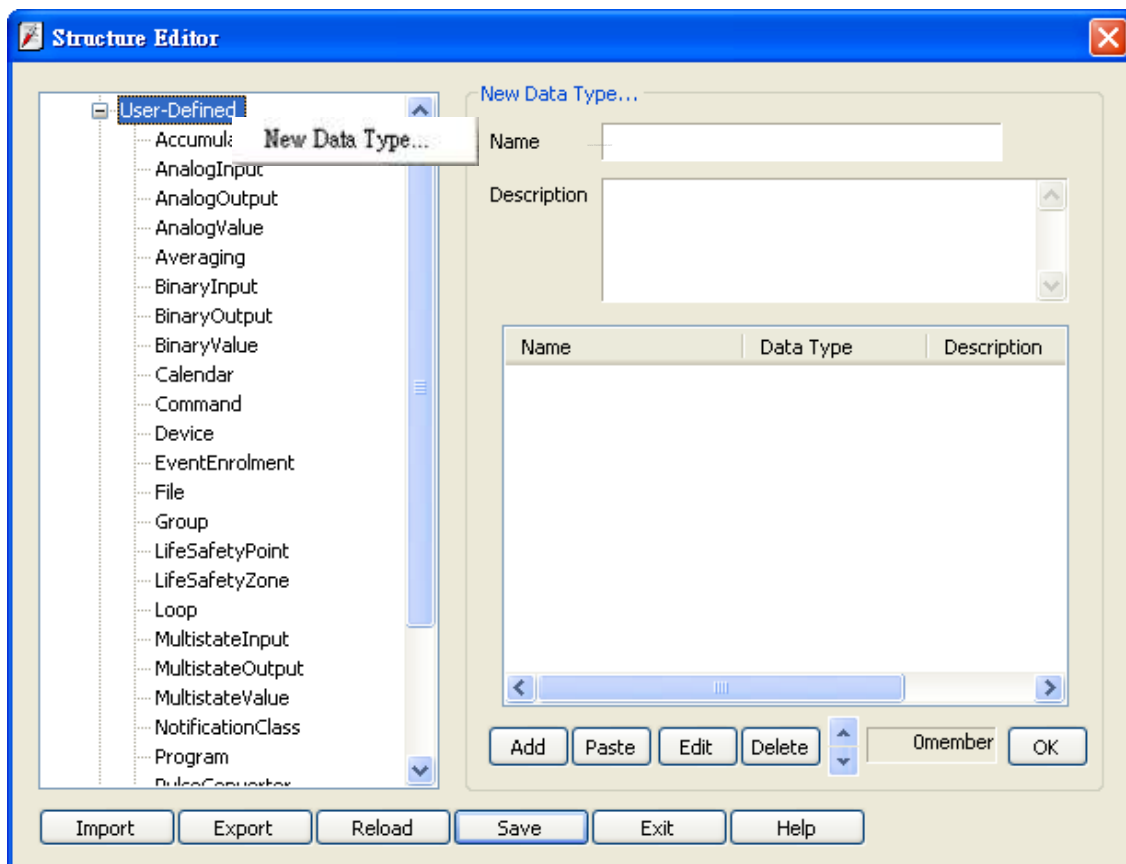

Step 2

After adding all Program Tags, click **[OK]** » **[Save]** » **[Exit]** to leave the editor dialog.

TYPE	SCOPE	NAME	DESCRIPTION	DATATYPE	SPECIFIER
ALIAS	ConveyorProgram	Output_Conveyor			Local:2:O.Data.2
TAG	ConveyorProgram	PB_Conveyor		BOOL	
TYPE	SCOPE	NAME	DESCRIPTION	DATATYPE	SPECIFIER
ALIAS	MainProgram	Output_Light			Local:2:O.Data.1
TAG	MainProgram	PB		BOOL	

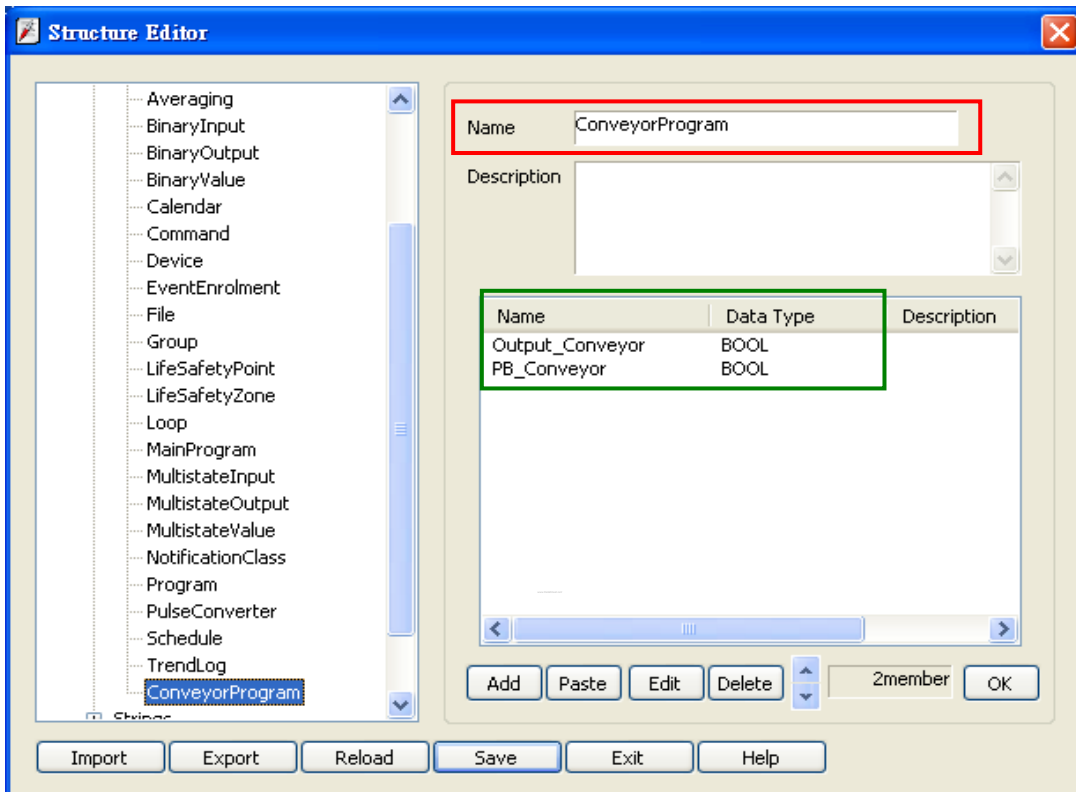

- In **[System Parameter Settings]**, click **[Import Tag]**, select the csv file. After importing a message window is displayed.

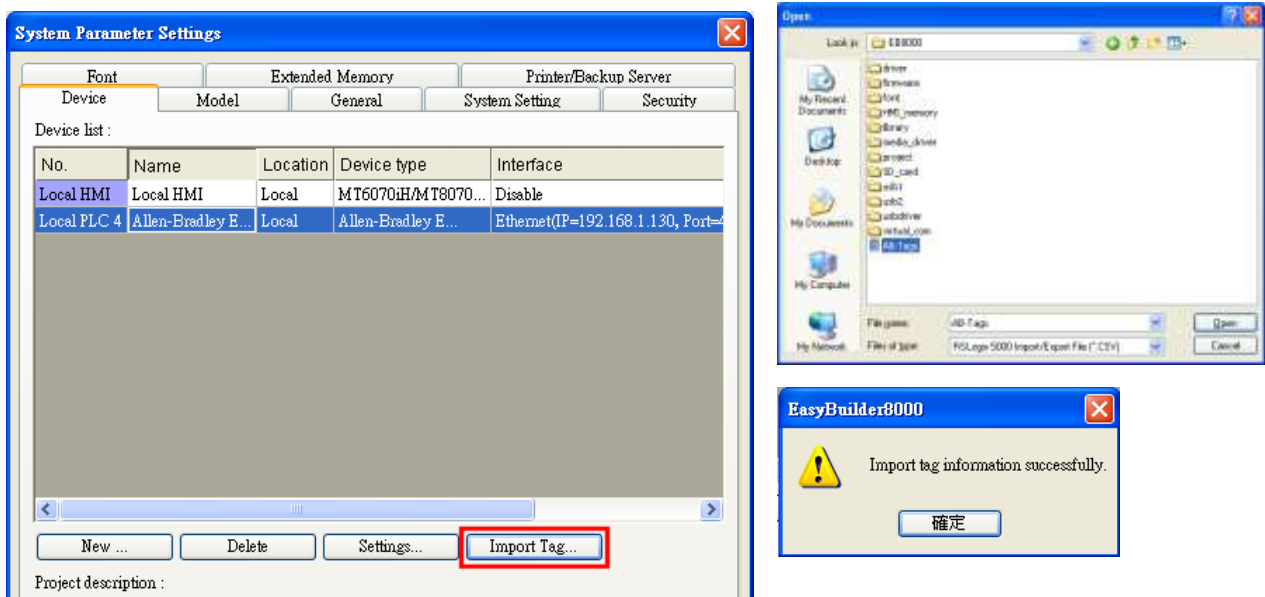

- In the object property dialog, select PLC Tag address.

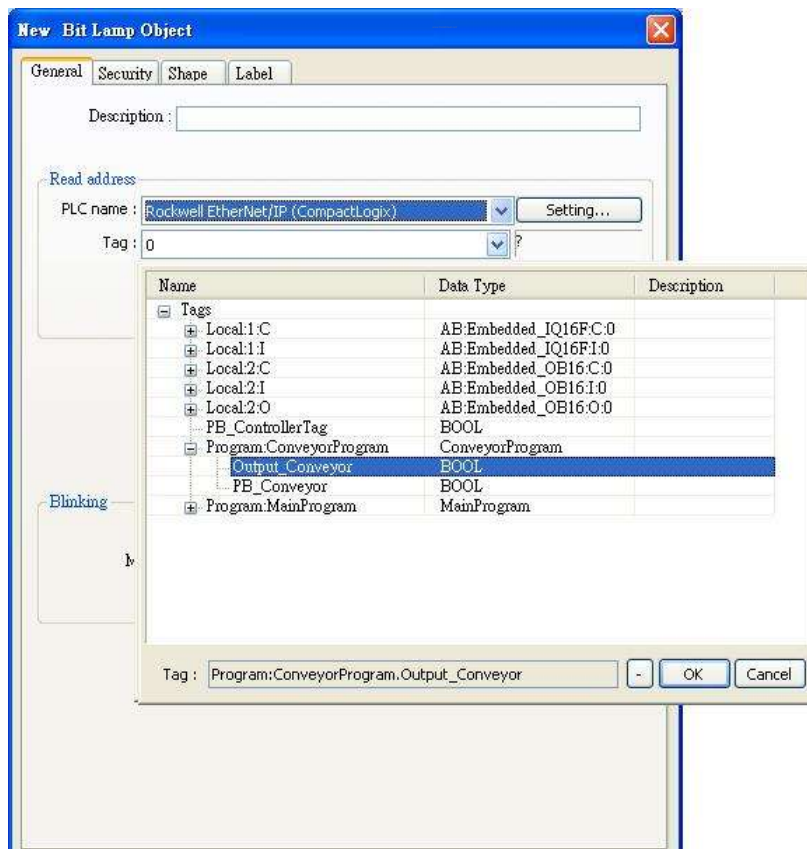

Device Address:

PLC data type name	Bit/Word	EasyBuilder data format	Memo
BOOL	Boolean	Bit object	
BitArray			
SINT			
INT	Integer	16-bit signed, ASCII	-32768 ~ 32767
DINT	Double Integer	32-bit signed	$-2^{31} \sim (2^{31}-1)$
REAL	Single Precision Float	32-bit Float	IEEE 754

Wiring Diagram:

Direct connect (crossover cable):

HMI RJ45 Male	Wire Color	PLC RJ45 Male
1 TX+	White/Orange	3 RX+
2 TX-	Orange	6 RX-
3 RX+	White/Green	1 TX+
4 BD4+	Blue	4 BD4+
5 BD4-	White/Blue	5 BD4-
6 RX-	Green	2 TX-
7 BD3+	White/Brown	7 BD3+
8 BD3-	Brown	8 BD3-



Through a hub:

HMI RJ45 Male	Wire Color	PLC RJ45 Male
1 TX+	White/Orange	1 TX+
2 TX-	Orange	2 TX-
3 RX+	White/Green	3 RX+
4 BD4+	Blue	4 BD4+
5 BD4-	White/Blue	5 BD4-
6 RX-	Green	6 RX-
7 BD3+	White/Brown	7 BD3+
8 BD3-	Brown	8 BD3-



Driver Version:

Version	Date	Description
V1.10	Oct/05/2010	

Rockwell EtherNet/IP (DF1)

Supported Series: Rockwell MicroLogix 1100, 1400, SLC5/05 Ethernet port.
MicroLogix1000, 1200, 1500, SLC 5/03, 5/04 with 1761-NET-ENI

Website: <http://www.ab.com>

HMI Setting:

Parameters	Recommended	Options	Notes
PLC type	Allen-Bradley EtherNet/IP (DF1)		
PLC I/F	Ethernet		
Port no.	44818		
HMI sta. no.	0		
PLC sta. no.	1		

PLC Setting:

Communication mode	Port Setting: 10/100 Mbps Full Duplex/Half Duplex
--------------------	---

Device Address:

Bit/Word	Device type	Format	Range	Memo
B	I1	DDDdd	0 ~ 25515	Input (I)
B	O0	DDDdd	0 ~ 25515	Output (O)
B	B3	DDDdd	0 ~ 25515	Bit data file (B3)
B	S_Bit	DDDDDDdd	0 ~ 25525515	Status file
B	Bfn	FFFDDDdd	0 ~ 25525515	Bit data file (B3, 10 ~ 254)
B	NfnBit	FFFDDDdd	0 ~ 25525515	Integer data file bit level (N7, 10 ~ 254)
W	T4SV	DDD	0 ~ 255	Timer Preset Value (T4)
W	T4PV	DDD	0 ~ 255	Timer Accumulator Value (T4)
W	C5SV	DDD	0 ~ 255	Counter Preset Value (C5)
W	C5PV	DDD	0 ~ 255	Counter Accumulator Value (C5)
W	TfnSV	FFFDDD	0 ~ 255255	
W	TfnPV	FFFDDD	0 ~ 255255	
W	CfnSV	FFFDDD	0 ~ 255255	

Bit/Word	Device type	Format	Range	Memo
W	CfnPV	FFFDDD	0 ~ 255255	
W	S	DDD	0 ~ 255	
W	N7	DDD	0 ~ 255	Integer data file (N7)
W	Nfn	FFFDDD	0 ~ 255255	Integer data file (N7, 10 ~ 254)
DW (F)	F8	DDD	0 ~ 255	Floating point data file (F8)
DW (F)	Ffn	FFFDDD	0 ~ 255255	Floating point data file (F8, 10 ~ 254)
DW	Lfn	FFFDDD	0 ~ 255255	Driver version 2.00 or later supported

Wiring Diagram:

Direct connect (crossover cable):

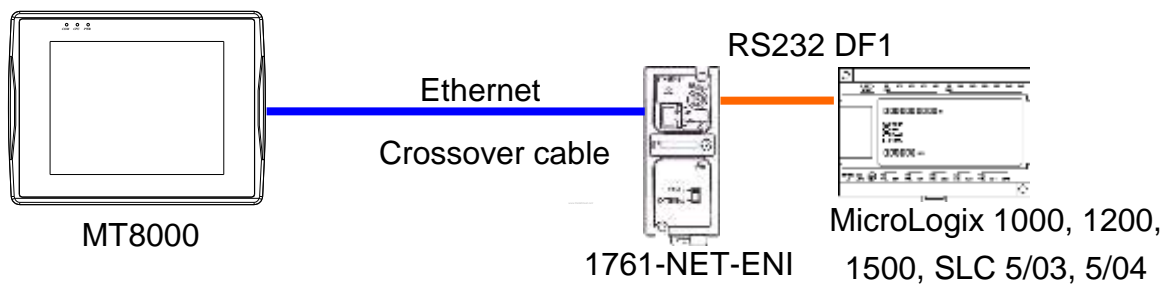

HMI RJ45 Male	Wire Color	Wire Color	PLC RJ45 Male
1 TX+	White/Orange	White/Green	3 RX+
2 TX-	Orange	Green	6 RX-
3 RX+	White/Green	White/Orange	1 TX+
4 BD4+	Blue	Blue	4 BD4+
5 BD4-	White/Blue	White/Blue	5 BD4-
6 RX-	Green	Orange	2 TX-
7 BD3+	White/Brown	White/Brown	7 BD3+
8 BD3-	Brown	Brown	8 BD3-

Through a hub:

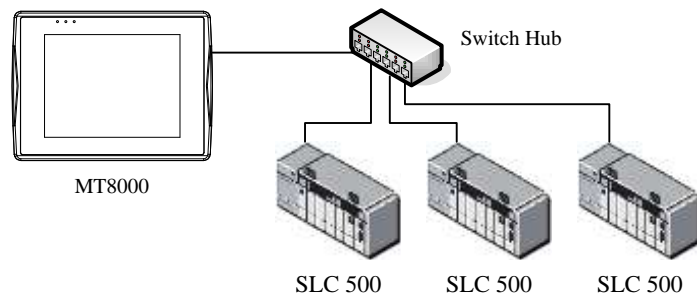

HMI RJ45 Male	Wire Color	Wire Color	PLC RJ45 Male
1 TX+	White/Orange	White/Orange	1 TX+
2 TX-	Orange	Orange	2 TX-
3 RX+	White/Green	White/Green	3 RX+
4 BD4+	Blue	Blue	4 BD4+
5 BD4-	White/Blue	White/Blue	5 BD4-
6 RX-	Green	Green	6 RX-
7 BD3+	White/Brown	White/Brown	7 BD3+
8 BD3-	Brown	Brown	8 BD3-



Driver Version:

Version	Date	Description
V2.00	Dec/21/2009	Add Lfn register.

Rockwell PLC5

Website: <http://www.ab.com>

HMI Setting:

Parameters	Recommended	Options	Notes
PLC type	Allen-Bradley PLC5		
PLC I/F	RS232		
Baud rate	19200	9600, 19200	
Data bits	8	8	
Parity	Even	Even, Odd, None	
Stop bits	1	1	
HMI sta. no.	0		
PLC sta. no.	1	1-31	

PLC Setting:

Communication mode	DF1 Full Duplex protocol 19200, None, 8, 1 (default)
--------------------	--

Allen-Bradley PLC-5 Family PLCs use DF1 Full Duplex protocol.

For PLC-5/10, PLC-5/15 and PLC-5/25, MT8000 should be connected to the DF1 port on the 1785-KE module.

For PLC-5/11, PLC-5/20, PLC-5/30 and PLC-5/40, MT8000 should be connected to the Channel 0 Port on the PLC.

Device Address:

Bit/Word	Device type	Format	Range	Memo
B	I1	DDDdd	0 ~ 25515	Input (I)
B	O0	DDDdd	0 ~ 25515	Output (O)
B	B3	DDDdd	0 ~ 99915	Bit data file (B3)
B	B10 ~ 13	DDDdd	0 ~ 99915	Bit data file (B10 ~ 13)
B	S_Bit	DDDDDDdd	0 ~ 25599915	
B	Bfn	FFFDDDDdd	0 ~ 25599915	
B	NfnBit	FFFDDDDdd	0 ~ 25599915	
W	T4SV	DDD	0 ~ 999	Timer Preset Value (T4)



Bit/Word	Device type	Format	Range	Memo
W	T4PV	DDD	0 ~ 999	Timer Accumulator Value (T4)
W	C5SV	DDD	0 ~ 999	Counter Preset Value (C5)
W	C5PV	DDD	0 ~ 999	Counter Accumulator Value (C5)
W	TfnSV	FFFDDD	0 ~ 255999	
W	TfnPV	FFFDDD	0 ~ 255999	
W	CfnSV	FFFDDD	0 ~ 255999	
W	CfnPV	FFFDDD	0 ~ 255999	
W	N7	DDD	0 ~ 999	Integer data file (N7)
W	N10 ~ 15	DDD	0 ~ 999	Integer data file (N10 ~ 15)
W	Nfn	FFFDDD	0 ~ 255999	Integer data file (V2.5.0 or newer)
W	S	DDD	0 ~ 255	
W	F8	DDD	0 ~ 999	Floating point data file (F8)
W	Ffn	FFFDDD	0 ~ 255999	Floating point data file (V2.5.0 or newer)

Wiring Diagram:

The following represents the view of HMI & PLC.

9P D-Sub to 25P D-Sub: PLC5 CPU CH0

eMT3000 series

COM1 RS232 9P D-Sub Female	COM3 RS232 9P D-Sub Female		AB CPU CH0 RS232 25P D-Sub Male
2 RX	8 RX		3 TD
3 TX	7 TX		2 RD
5 GND	5 GND		7 GND
			

MT6000/8000 series except MT6050i/MT8050i

COM1 RS232 9P D-Sub Female	COM2 RS232 9P D-Sub Female	COM3 RS232 9P D-Sub Male	AB CPU CH0 RS232 25P D-Sub Male
2 RX	6 RX	8 RX	3 TD
3 TX	4 TX	7 TX	2 RD
5 GND	5 GND	5 GND	7 GND

MT6050i/MT8050i

COM1 RS232 9P D-Sub Female			AB CPU CH0 RS232 25P D-Sub Male
9 RX			3 TD
6 TX			2 RD
5 GND			7 GND

Note:

The default error checking of AB PLC5 is BCC, whereas our driver is CRC.

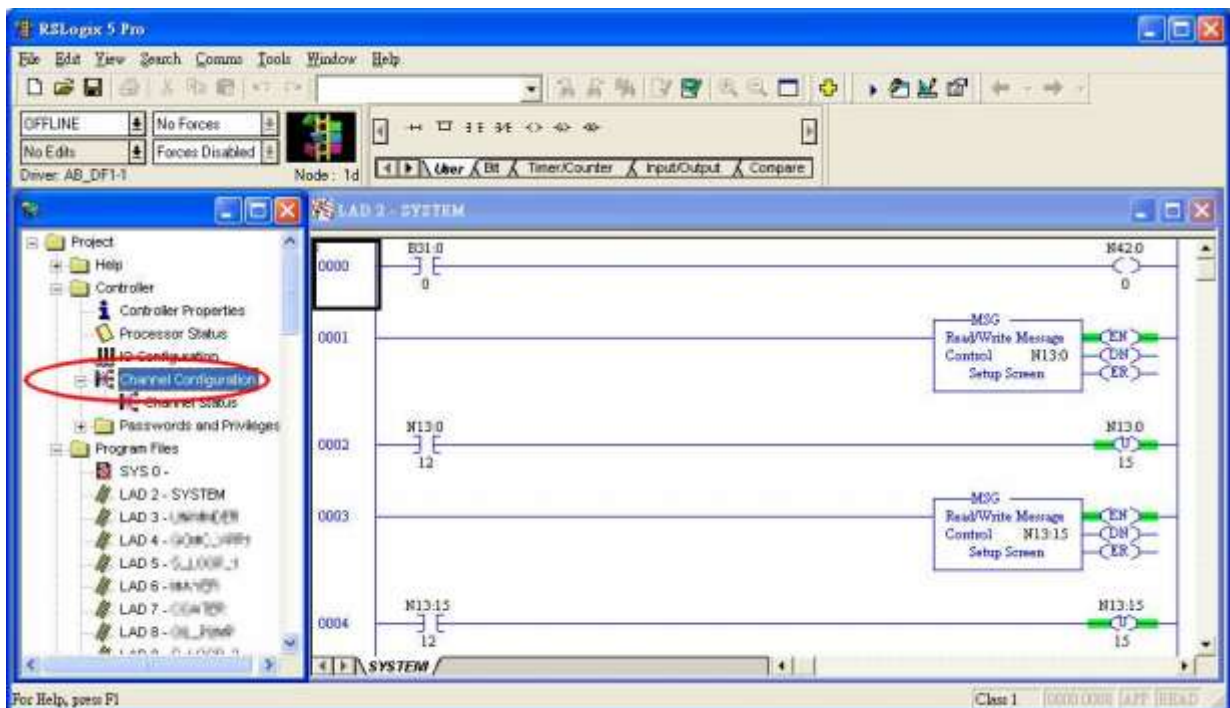

Access [Channel Configuration] from RSLogix5, under Channel 0 tab, please select “CRC” for [Error Detect].

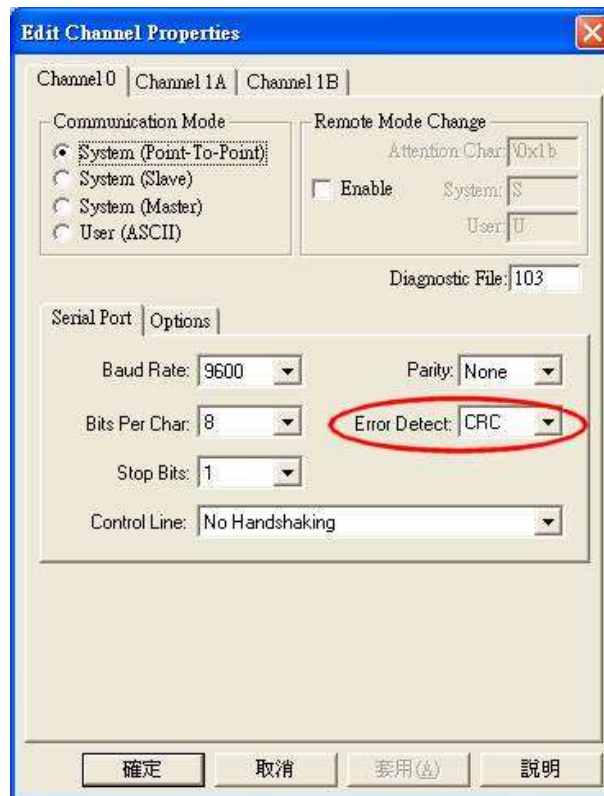

Driver Version:

Version	Date	Description
V1.20	Apr/17/2009	

RS Automation OEMAX Series

Supported Series: OEMax NX7/NX7s Controllers.

Website: <http://www.oemax.co.kr>

HMI Setting:

Parameters	Recommended	Options	Notes
PLC type	RS Automation OEMAX Series		
PLC I/F	RS232		
Baud rate	9600	9600, 19200, 38400	
Data bits	8	8	
Parity	None	Even, Odd, None	
Stop bits	1	1	
PLC sta. no.	0		
HMI sta. no.	225	0 ~ 255	*Please correctly set HMI station number.



Device Address:

Bit/Word	Device type	Format	Range	Memo
B	R	DDDdd	0 ~ 25515	
B	L	DDDdd	0 ~ 25515	
B	M	DDDDdd	0 ~ 199915	
B	K	DDDdd	0 ~ 25515	Keep Contact
B	F	DDDdd	0 ~ 99115	Special Contact
B	TC	DDD	0 ~ 255	Timer/Counter
W	W	DDDD	0 ~ 7999	Data Register
W	SV	DDD	0 ~ 255	Timer/Counter Set Value
W	PV	DDD	0 ~ 255	Timer/Counter Preset Value
W	SR	DDD	0 ~ 255	Special Register
W	WR	DDD	0 ~ 255	
W	WL	DDD	0 ~ 255	
W	WM	DDDD	0 ~ 1999	
W	WK	DDD	0 ~ 255	
W	WF	DDD	0 ~ 991	





Wiring Diagram:

The following represents the view of HMI & PLC.



eMT3000 series

COM1 RS232 9P D-Sub Female	COM3 RS232 9P D-Sub Female		Port1 RS232 9P D-Sub Male
2 RX	8 RX		2 TXD
3 TX	7 TX		3 RXD
5 GND	5 GND		5 GND
			

MT6000/8000 series except MT6050i/MT8050i

COM1 RS232 9P D-Sub Female	COM2 RS232 9P D-Sub Female	COM3 RS232 9P D-Sub Male	Port1 RS232 9P D-Sub Male
2 RX	6 RX	8 RX	2 TXD
3 TX	4 TX	7 TX	3 RXD
5 GND	5 GND	5 GND	5 GND
			

MT6050i/MT8050i

COM1 RS232 9P D-Sub Female			Port1 RS232 9P D-Sub Male
9 RX			2 TXD
6 TX			3 RXD
5 GND			5 GND
			

Driver Version:

Version	Date	Description
V1.00	Dec/30/2008	Driver released.
V1.20	Jun/27/2012	Support more station numbers.

SAIA PCD PGU Mode

Supported Series : SAIA PCD series PGU mode.

Website : <http://www.saia-burgess.com/>

HMI Setting:

Parameters	Recommended	Options	Notes
PLC type	SAIA PCD PGU Mode		PDS driver
PLC I/F	RS232	RS232, RS485	
Baud rate	9600	9600, 19200	
Data bits	7	7,8	
Parity	Even	Even, Odd, None	
Stop bits	1	1	
PLC sta. no.	1	0-255	



Device Address:

Bit/Word	Device type	Format	Range	Memo
B	Flag	DDDD	0 ~ 8191	
B	Output	DDD	0 ~ 511	
B	Input	DDD	0 ~ 511	
W	Register	DDDD	0 ~ 4095	
W	Counter	DDDD	0 ~ 1599	
W	Timer	DDDD	0 ~ 1599	
W	Reg_Float	DDDD	0 ~ 4095	support single float point
W	Reg_Word	DDDD	0 ~ 4095	



Wiring Diagram:

The following represents the view of HMI & PLC.

eMT3000 series

COM1 RS232 9P D-Sub Female			RS232 9P D-Sub Male
2 RX			3 TXD
3 TX			2 RXD
5 GND			5 GND
7 RTS			6 DSR
			7 RTS
			8 CTS
			circuit
			

MT6000/8000 series except MT6050i/MT8050i

COM1 RS232 9P D-Sub Female			RS232 9P D-Sub Male
2 RX			3 TXD
3 TX			2 RXD
5 GND			5 GND
7 RTS			6 DSR
			7 RTS
			8 CTS
			circuit
			

6 DSR (Of PGU Port): PGU connected.

Driver Version:

Version	Date	Description
V1.02	Dec/30/2008	

SAIA PCD S-BUS Mode

Supported Series: SAIA PCD series S-Bus mode.

Website: <http://www.saia-burgess.com/>

HMI Setting:

Parameters	Recommended	Options	Notes
PLC type	SAIA PCD S-BUS Mode		PDS driver
PLC I/F	RS232	RS232, RS485	
Baud rate	9600	9600, 19200, 38400	
Data bits	8	7,8	
Parity	None	Even, Odd, None	
Stop bits	1	1	
PLC sta. no.	0	0-255	

PLC Setting:

Communication mode	9600,N,8,1 (default)
RS232	Port 0-Type: RS232
RS485 2W	S-BUS Mode: Data(S2), Port 1-Type: RS485

甲、Open Saia Project Manager SP2.0.150 and create a new project.

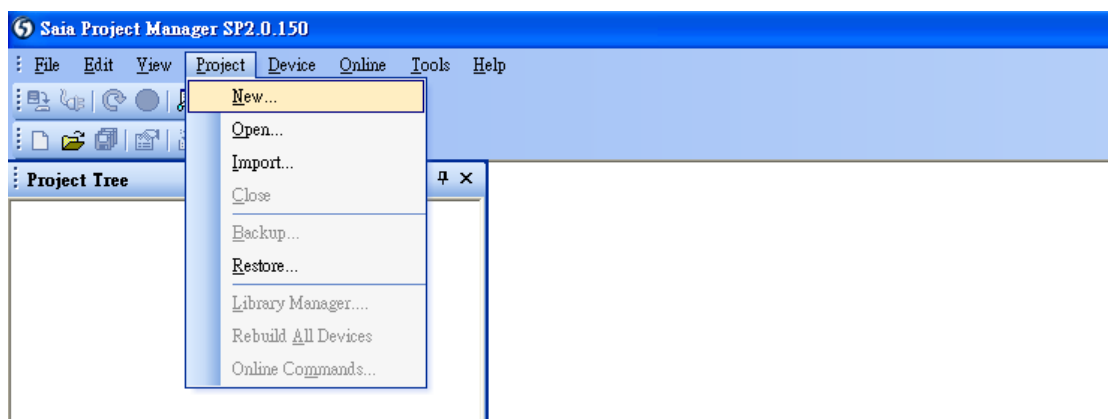

乙、Give a project name.

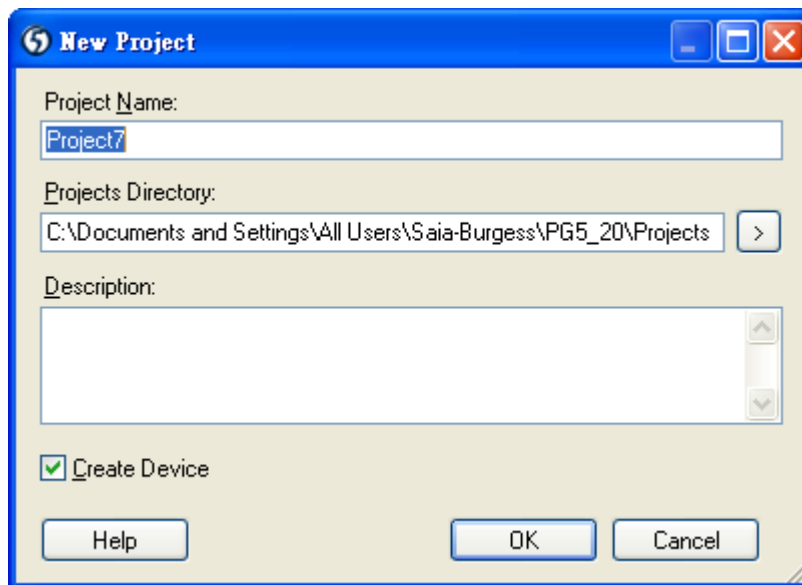

丙、Create a new project as below.

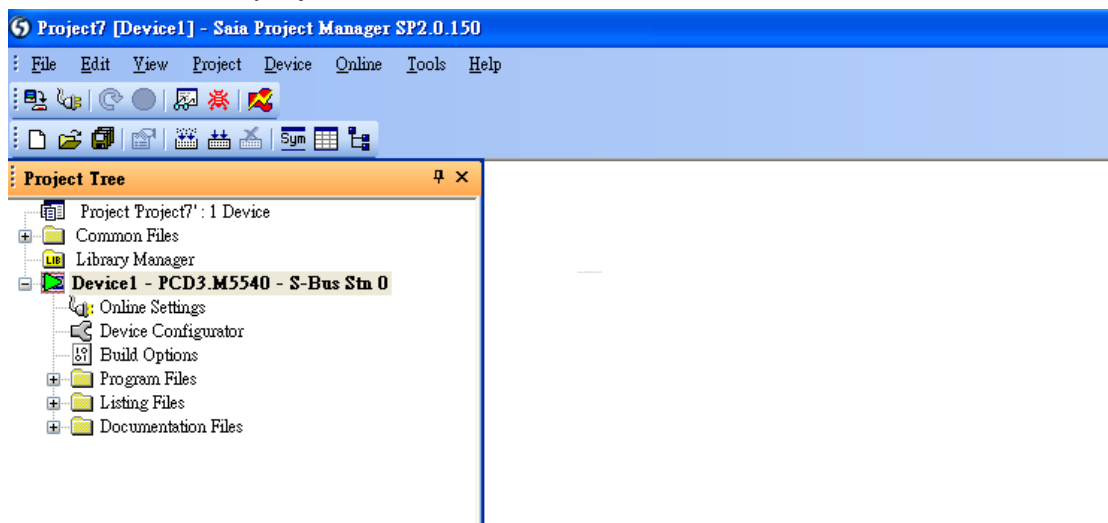

丁、Go to “Online Setting”.

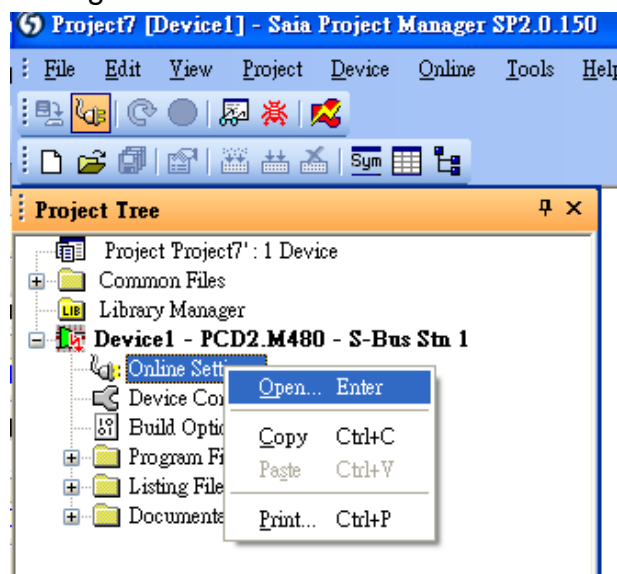

戊、Select "PGU".

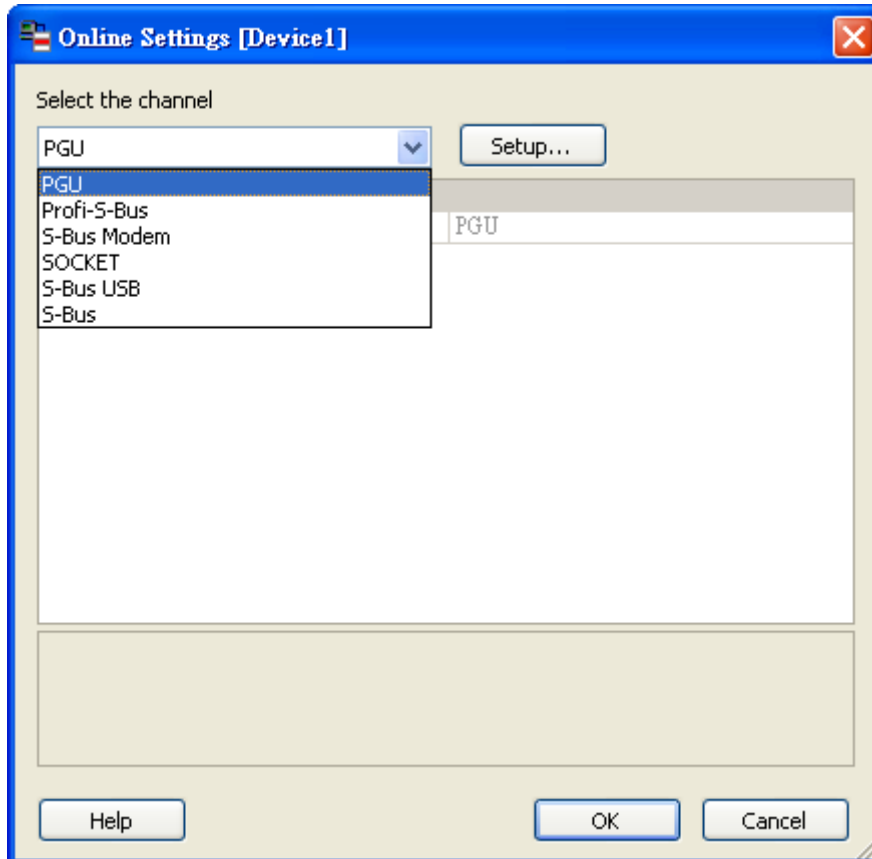

己、Go to "Device Configurator".

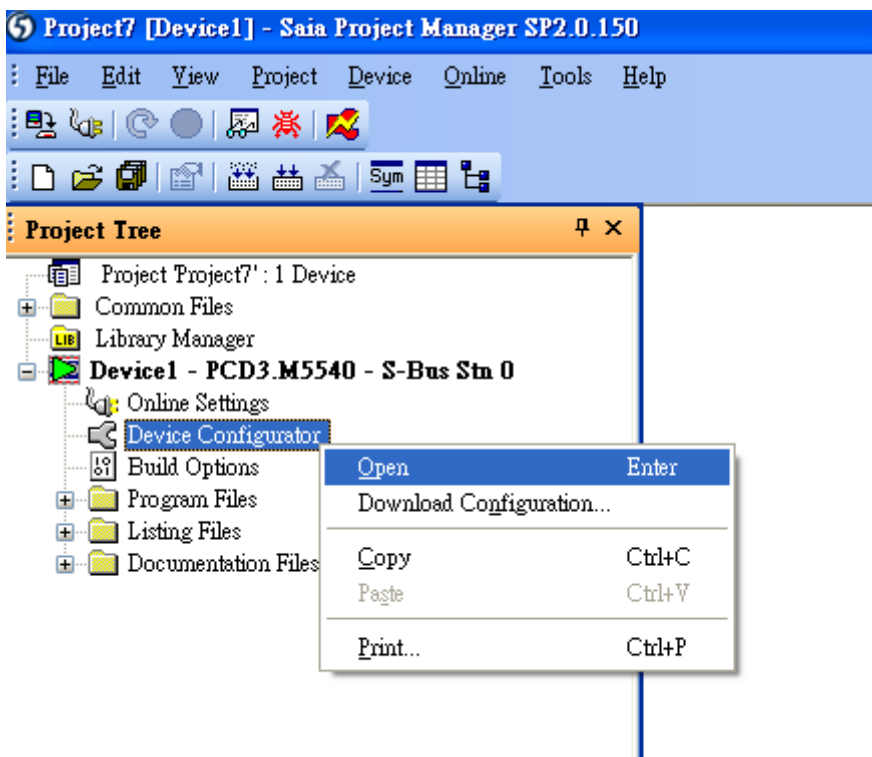

庚、Click "Change Device Type" to select your PLC model.

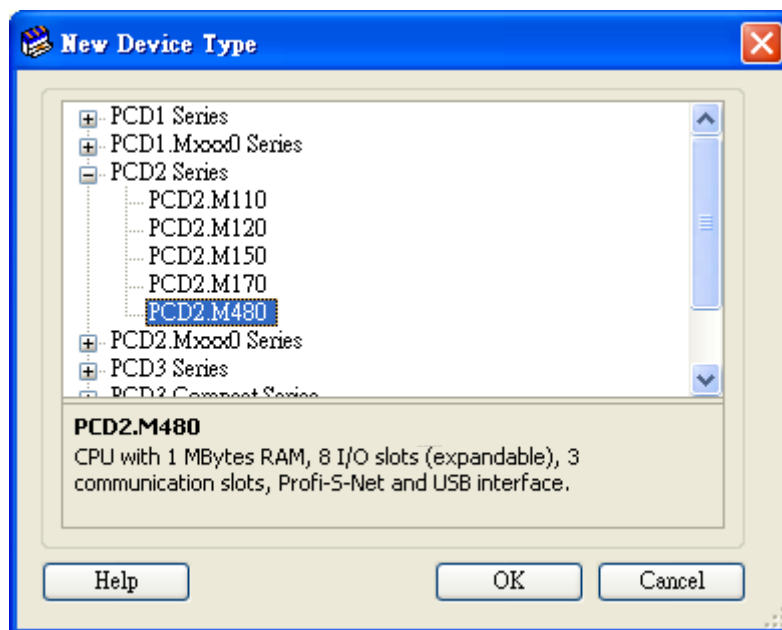
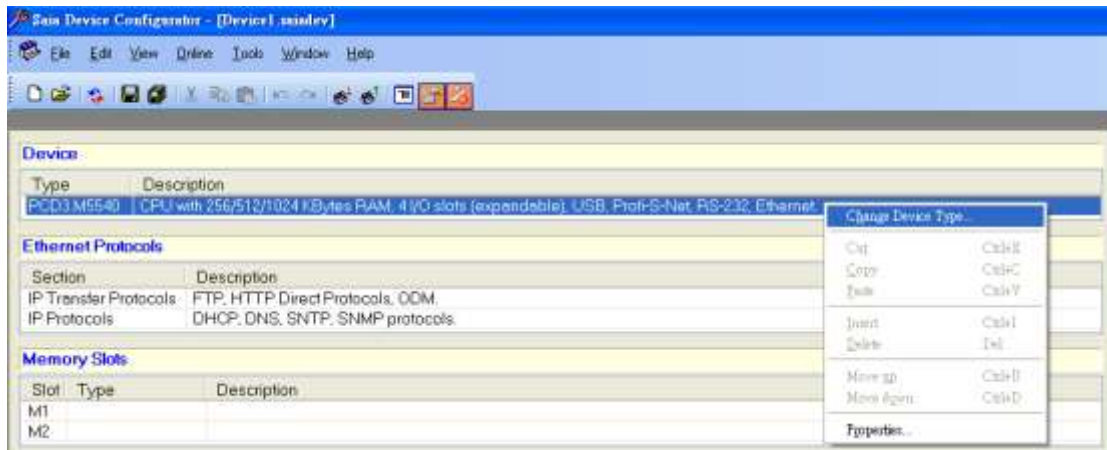

辛、Select RS232 (PGU) in Type and then right click mouse on Onboard Communications and select "Properties".

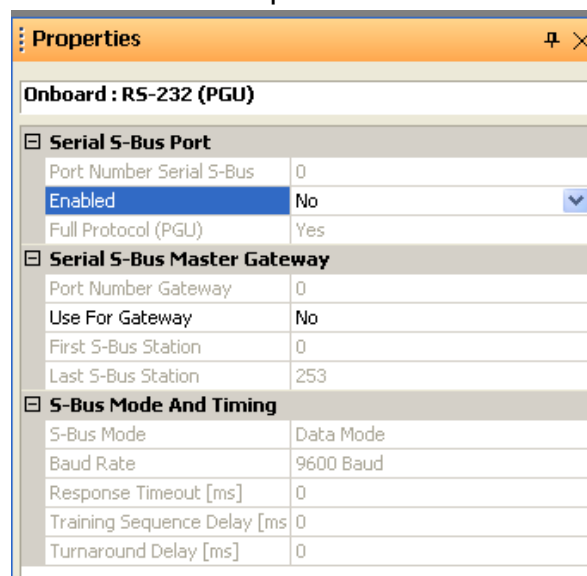

壬、Select “Yes” in Series S-Bus Port: Enabled.

Properties		
Onboard : RS-232 (PGU)		
Serial S-Bus Port		
Port Number Serial S-Bus	0	
Enabled	Yes	
Full Protocol (PGU)	Yes	
Serial S-Bus Master Gateway		
Port Number Gateway	0	
Use For Gateway	No	
First S-Bus Station	0	
Last S-Bus Station	253	
S-Bus Mode And Timing		
S-Bus Mode	Data Mode	
Baud Rate	9600 Baud	
Response Timeout [ms]	0	
Training Sequence Delay [ms]	0	
Turnaround Delay [ms]	0	

癸、Set parameters in S-Bus Mode and Timing then upload to PLC.

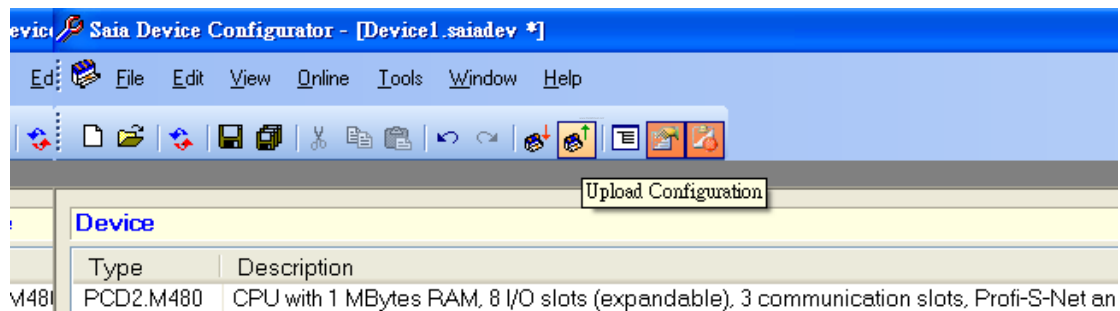

Upload Configuration ✖

Device configuration file name :

C:\Documents and Settings\All Users\Saia-Burgess\PG5_20\Projects\Project7\Device1\Device1.s

Upload on :

PGU

11、 Go to Online Settings >> Open to select S-Bus for finishing the PLC settings.

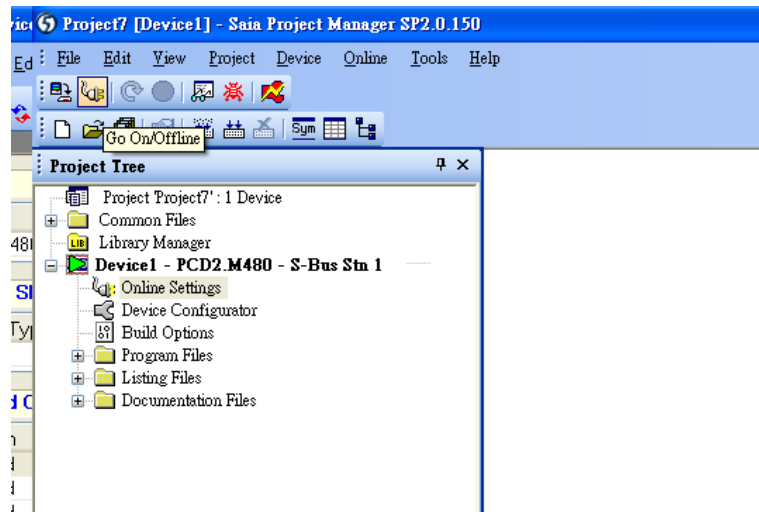
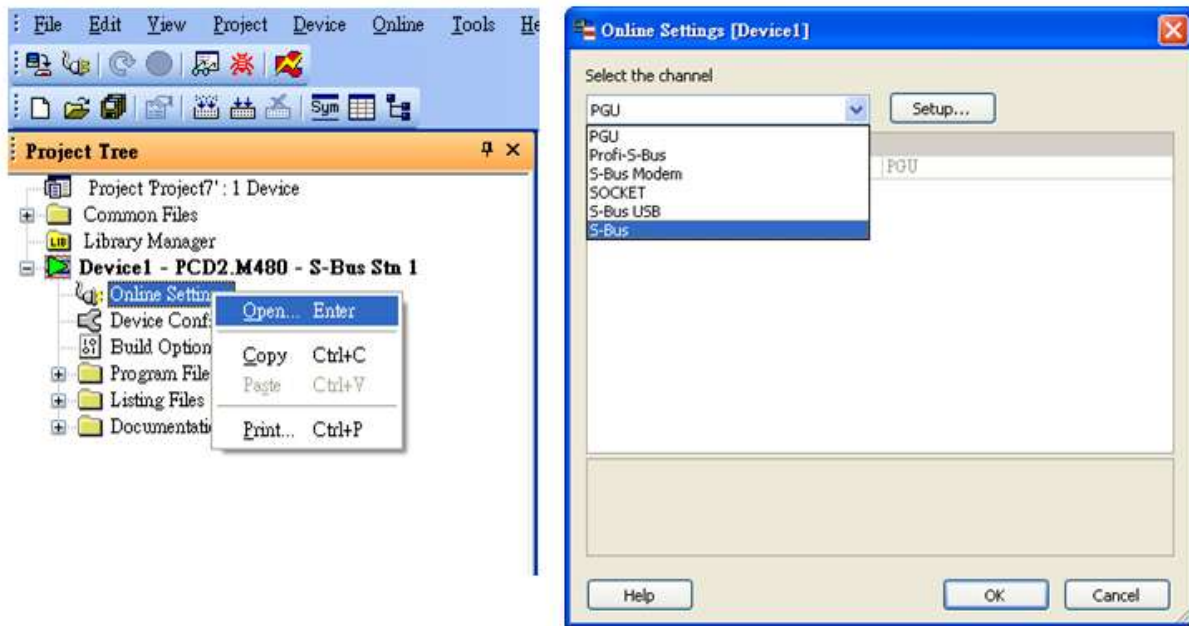

Device Address:



Bit/Word	Device type	Format	Range	Memo
B	Flag	DDDD	0 ~ 8191	
B	Output	DDDD	0 ~ 1023	
B	Input	DDDD	0 ~ 1023	
B	Reg_Bit	DDDDdd	0 ~ 1638331	dd: Bit no. (00~31)
DW	Register	DDDDD	0 ~ 16383	
DW	Counter	DDDD	0 ~ 1599	
DW	Timer	DDDD	0 ~ 1599	
DW	Reg_Float	DDDDD	0 ~ 16383	support single float point
DW	DBn	DDDDDDDDD	0 ~ 536016383	

Wiring Diagram:





The following represents the view of HMI & PLC.

SAIA PCD PGU Port



eMT3000 series

COM1 RS232 9P D-Sub Female	COM3 RS232 9P D-Sub Female		RS232 9P D-Sub Male
2 RX	8 RX		3 TXD
3 TX	7 TX		2 RXD
5 GND	5 GND		5 GND
			7 RTS
			8 CTS
			circuit
			

MT6000/8000 series except MT6050i/MT8050i

COM1 RS232 9P D-Sub Female	COM2 RS232 9P D-Sub Female	COM3 RS232 9P D-Sub Male	RS232 9P D-Sub Male
2 RX	6 RX	8 RX	3 TXD
3 TX	4 TX	7 TX	2 RXD
5 GND	5 GND	5 GND	5 GND
			7 RTS
			8 CTS
			circuit
			



MT6050i/MT8050i

COM1 RS232 9P D-Sub Female			RS232 9P D-Sub Male
9 RX			3 TXD
6 TX			2 RXD
5 GND			5 GND
			7 RTS
			8 CTS
			circuit
			



The following represents the view of HMI & PLC.

SAIA PCD1 Port #1 (Port #0) Terminal



eMT3000 series

COM1 RS485 2W 9P D-Sub Male	COM3 RS485 2W 9P D-Sub Male		SAIA PCD1 Port #1 (Port #0) Terminal
1 RX-	6 Data-		11 (29)
2 RX+	9 Data+		12 (28)
5 GND	5 GND		
			

MT6000/8000 series except MT6050i/MT8050i

COM1 RS485 2W 9P D-Sub Male	COM3 RS485 2W 9P D-Sub Male		SAIA PCD1 Port #1 (Port #0) Terminal
1 RX-	6 Data-		11 (29)
2 RX+	9 Data+		12 (28)
5 GND	5 GND		
			

MT6050i/MT8050i

COM1 RS485 2W 9P D-Sub Female	COM3 RS485 2W 9P D-Sub Female		SAIA PCD1 Port #1 (Port #0) Terminal
1 RX-	7 Data-		11 (29)
2 RX+	8 Data+		12 (28)
5 GND	5 GND		
			

Driver Version:

Version	Date	Description
V1.40	Jun/21/2012	DBn address types are added.

SAIA S-BUS (Ethernet)

Supported Series : SAIA PCD series Ethernet-TCP/IP.

Website : <http://www.saia-burgess.com/>

HMI Setting:

Parameters	Recommended	Options	Notes
PLC type	SAIA S-BUS (Ethernet)		
PLC I/F	Ethernet		
Port no.	5050		
PLC sta. no.	0		

PLC Setting:

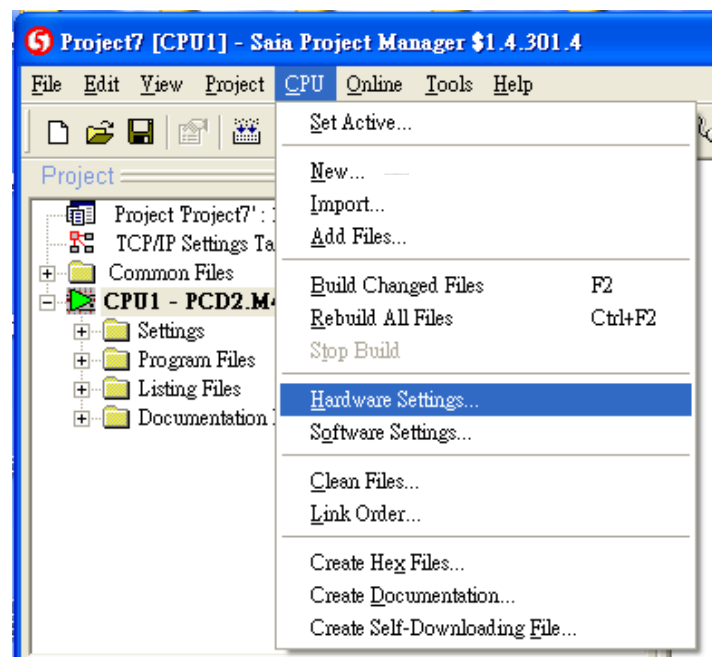

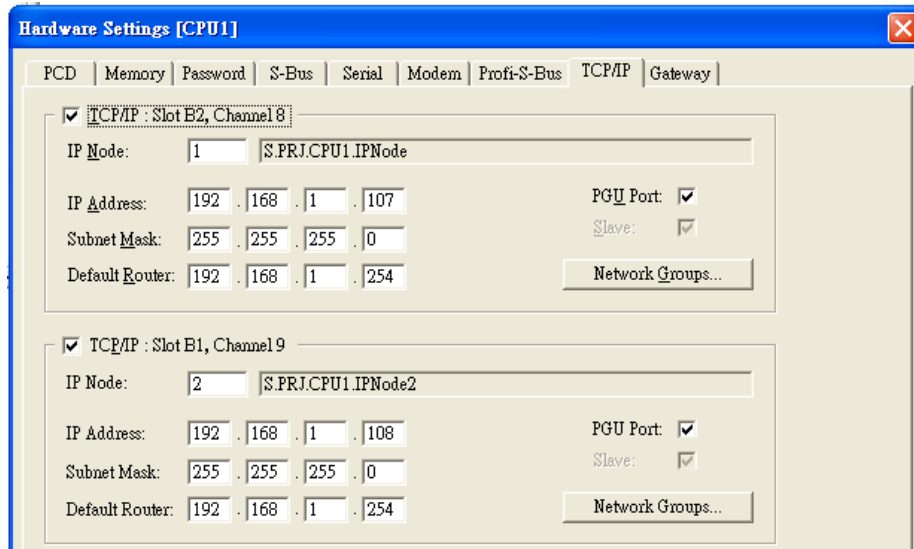

Device Address:

Bit/Word	Device type	Format	Range	Memo
B	Flag	DDDD	0 ~ 8191	
B	Output	DDDD	0 ~ 1023	
B	Input	DDDD	0 ~ 1023	
B	Reg_Bit	DDDDdd	0 ~ 1638331	dd: Bit no. (00 ~ 31)
DW	Register	DDDDD	0 ~ 16383	
DW	Counter	DDDD	0 ~ 1599	
DW	Timer	DDDD	0 ~ 1599	
DW	Reg_Float	DDDDD	0 ~ 16383	support single float point
DW	DBn	DDDDDDDD	0 ~ 536016383	

Wiring Diagram:

Direct connect (crossover cable):

HMI RJ45 Male	Wire Color	PLC RJ45 Male
1 TX+	White/Orange	3 RX+
2 TX-	Orange	6 RX-
3 RX+	White/Green	1 TX+
4 BD4+	Blue	4 BD4+
5 BD4-	White/Blue	5 BD4-
6 RX-	Green	2 TX-
7 BD3+	White/Brown	7 BD3+
8 BD3-	Brown	8 BD3-



Through a hub:

HMI RJ45 Male	Wire Color	PLC RJ45 Male
1 TX+	White/Orange	1 TX+
2 TX-	Orange	2 TX-
3 RX+	White/Green	3 RX+
4 BD4+	Blue	4 BD4+
5 BD4-	White/Blue	5 BD4-
6 RX-	Green	6 RX-
7 BD3+	White/Brown	7 BD3+
8 BD3-	Brown	8 BD3-



Driver Version:

Version	Date	Description
V1.40	Jun/21/2012	DBn address types are added.

Samsung SPC-10

Supported Series: Samsung SPC-10

Website: http://www.samsungelectronics.com/factory_automation/controller/plc/

HMI Setting:

Parameters	Recommended	Options	Notes
PLC type	Samsung SPC-10		
PLC I/F	RS485 2W		
Baud rate	9600		
Data bits	None		
Parity	8		
Stop bits	1		
PLC sta. no.	192		



Device Address:

Bit/Word	Device type	Format	Range	Memo
B	R	DDDDdd	0 ~ 999915	
B	K	DDDDdd	0 ~ 999915	
B	M	DDDDdd	0 ~ 999915	
B	F	DDDDdd	0 ~ 999915	
W	W	DDDD	0 ~ 9999	



Wiring Diagram:

The following represents the view of HMI & PLC.



eMT3000 series

COM1 RS485 2W 9P D-Sub Male	COM3 RS485 2W 9P D-Sub Male		RS485 2W 8P Mini-DIN Male
1 RX-	6 Data-		6 TR-
2 RX+	9 Data+		7 TR+
5 GND	5 GND		5 GND
			

MT6000/8000 series except MT6050i/MT8050i

COM1 RS485 2W 9P D-Sub Male	COM3 RS485 2W 9P D-Sub Male		RS485 2W 8P Mini-DIN Male
1 RX-	6 Data-		6 TR-
2 RX+	9 Data+		7 TR+
5 GND	5 GND		5 GND
			

MT6050i/MT8050i

COM1 RS485 2W 9P D-Sub Female	COM3 RS485 2W 9P D-Sub Female		RS485 2W 8P Mini-DIN Male
1 RX-	7 Data-		6 TR-
2 RX+	8 Data+		7 TR+
5 GND	5 GND		5 GND
			

Driver Version:

Version	Date	Description
V1.00	May/19/2009	

SCENE6 Controller

HMI Setting:

Parameters	Recommended	Options	Notes
PLC type	SCENE6 Controller		
PLC I/F	RS232		
Baud rate	9600		
Data bits	8		
Parity	None		
Stop bits	2		
PLC sta. no.	0		



Device Address:

Bit/Word	Device type	Format	Range	Memo
W	Word	DD	0 ~ 99	





Wiring Diagram:

The following represents the view of HMI & PLC.



eMT3000 series

COM1 RS232 9P D-Sub Female	COM3 RS232 9P D-Sub Female		RS232 Terminal
2 RX	8 RX		TD
3 TX	7 TX		RD
5 GND	5 GND		GND
			

MT6000/8000 series except MT6050i/MT8050i

COM1 RS232 9P D-Sub Female	COM2 RS232 9P D-Sub Female	COM3 RS232 9P D-Sub Male	RS232 Terminal
2 RX	6 RX	8 RX	TD
3 TX	4 TX	7 TX	RD
5 GND	5 GND	5 GND	GND
			

MT6050i/MT8050i

COM1 RS232 9P D-Sub Female			RS232 Terminal
9 RX			TD
6 TX			RD
5 GND			GND
			

Driver Version:

Version	Date	Description
V1.00	Aug/24/2009	

Schleicher XCS 20C

Supported Series: Schleicher XCx-Systems Ethernet port. Schleicher XCS series, 20C model.

Website: <http://www.schleicher-electronic.com>

HMI Setting:

Parameters	Recommended	Options	Notes
PLC type	Schleicher XCS 20C		
PLC I/F	RS232		
Baud rate	38400		
Data bits	8		
Parity	N		
Stop bits	1		
PLC sta. no.	0		

Device Address:

Bit/Word	Device type	Format	Range	Memo
B	IX	DDDDDo	0 ~ 655357	Input %IX
B	QX	DDDDDo	0 ~ 655357	Output %QX
B	MX	DDDDDo	0 ~ 655357	%MX
W	IW	DDDDD	0 ~ 65535	%IW
W	QW	DDDDD	0 ~ 65535	%QW
W	MW	DDDDD	0 ~ 65535	%MW
DW	ID	DDDDD	0 ~ 65535	%ID
DW	QD	DDDDD	0 ~ 65535	%QD
DW	MD	DDDDD	0 ~ 65535	%WD

- Word address must be even.

Wiring Diagram:

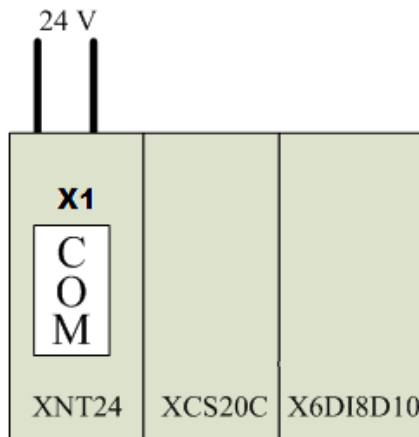

The following represents the view of HMI & PLC.



eMT3000 series

COM1 RS232 9P D-Sub Female	COM3 RS232 9P D-Sub Female		Schleicher XCS20 RS232 9P D-Sub Male
2 RX	8 RX		3 TD
3 TX	7 TX		2 RD
5 GND	5 GND		5 GND

MT6000/8000 series except MT6050i/MT8050i

COM1 RS232 9P D-Sub Female	COM2 RS232 9P D-Sub Female	COM3 RS232 9P D-Sub Male	Schleicher XCS20 RS232 9P D-Sub Male
2 RX	6 RX	8 RX	3 TD
3 TX	4 TX	7 TX	2 RD
5 GND	5 GND	5 GND	5 GND

MT6050i/MT8050i

COM1 RS232 9P D-Sub Female			Schleicher XCS20 RS232 9P D-Sub Male
9 RX			3 TD
6 TX			2 RD
5 GND			5 GND
			

Driver Version:

Version	Date	Description
V1.10	Feb/26/2010	

Schleicher XCX 300

Website: <http://www.schleicher-electronic.com>

HMI Setting:

Parameters	Recommended	Options	Notes
PLC type	Schleicher XCX 300		
PLC I/F	Ethernet	RS232, RS422, Ethernet	
Port no.	20547		
PLC sta. no.	2		

PLC Setting:

A variable must be created for HMI access.

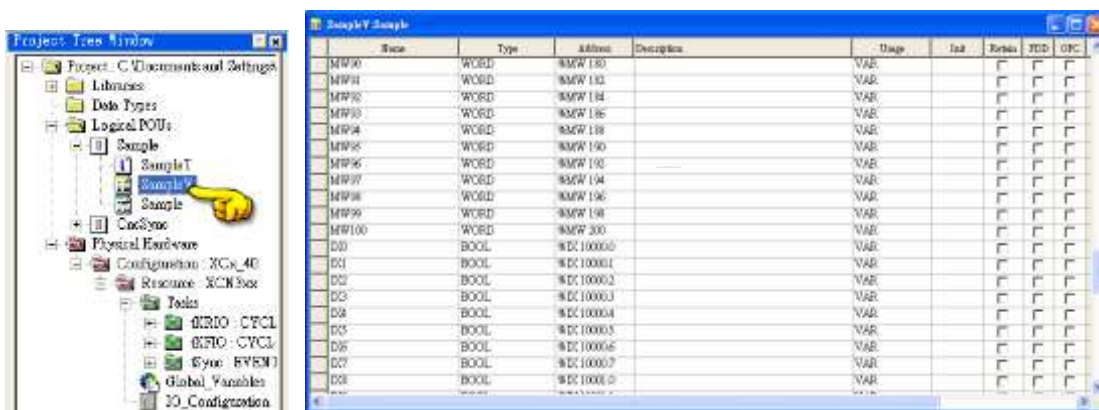

Device Address:

Bit/Word	Device type	Format	Range	Memo
B	IX	DDDDDo	0 ~ 655357	Input %IX
B	QX	DDDDDo	0 ~ 655357	Output %QX
B	MX	DDDDDo	0 ~ 655357	%MX
W	IW	DDDDD	0 ~ 65535	%IW
W	QW	DDDDD	0 ~ 65535	%QW
W	MW	DDDDD	0 ~ 65535	%MW
DW	ID	DDDDD	0 ~ 65535	%ID
DW	QD	DDDDD	0 ~ 65535	%QD
DW	MD	DDDDD	0 ~ 65535	%WD

- Word address must be even.

Wiring Diagram:

Direct connect (crossover cable):

HMI RJ45 Male	Wire Color	PLC RJ45 Male
1 TX+	White/Orange	3 RX+
2 TX-	Orange	6 RX-
3 RX+	White/Green	1 TX+
4 BD4+	Blue	4 BD4+
5 BD4-	White/Blue	5 BD4-
6 RX-	Green	2 TX-
7 BD3+	White/Brown	7 BD3+
8 BD3-	Brown	8 BD3-



Through a hub:



HMI RJ45 Male	Wire Color	PLC RJ45 Male
1 TX+	White/Orange	1 TX+
2 TX-	Orange	2 TX-
3 RX+	White/Green	3 RX+
4 BD4+	Blue	4 BD4+
5 BD4-	White/Blue	5 BD4-
6 RX-	Green	6 RX-
7 BD3+	White/Brown	7 BD3+
8 BD3-	Brown	8 BD3-







The following represents the view of HMI & PLC.

Schleicher XCX300 RS232 Port



eMT3000 series

COM1 RS232 9P D-Sub Female	COM3 RS232 9P D-Sub Female		RS232 9P D-Sub Female
2 RX	8 RX		3 TXD
3 TX	7 TX		2 RXD
5 GND	5 GND		5 GND
			

MT6000/8000 series except MT6050i/MT8050i

COM1 RS232 9P D-Sub Female	COM2 RS232 9P D-Sub Female	COM3 RS232 9P D-Sub Male	RS232 9P D-Sub Female
2 RX	6 RX	8 RX	3 TXD
3 TX	4 TX	7 TX	2 RXD
5 GND	5 GND	5 GND	5 GND
			



MT6050i/MT8050i

COM1 RS232 9P D-Sub Female			RS232 9P D-Sub Female
9 RX			3 TXD
6 TX			2 RXD
5 GND			5 GND
			



The following represents the view of HMI & PLC.

Schleicher XCX300 RS485 4W Terminal



eMT3000 series

COM1 RS485 4W 9P D-Sub Male			RS485 4W Terminal
1 RX-			TX-
2 RX+			TX+
3 TX-			RX-
4 TX+			RX+
5 GND			GND
			

MT6000/8000 series except MT6050i/MT8050i

COM1 RS485 4W 9P D-Sub Male			RS485 4W Terminal
1 RX-			TX-
2 RX+			TX+
3 TX-			RX-
4 TX+			RX+
5 GND			GND
			

MT6050i/MT8050i

COM1 RS485 4W 9P D-Sub Female			RS485 4W Terminal
1 RX-			TX-
2 RX+			TX+
3 TX-			RX-
4 TX+			RX+
5 GND			GND
			

Driver Version:

Version	Date	Description
V1.00	Nov/30/2009	Driver released.
V1.10	Jun/28/2010	Support RS232, RS422 interface connection.

Schneider MODBUS RTU

Supported Series : Schneider MODBUS RTU CONTROLLER

Website: <http://www.schleicher-electronic.com>

HMI Setting:

Parameters	Recommended	Options	Notes
PLC type	Schneider MODBUS RTU		
PLC I/F	RS485	RS232/RS485	
Baud rate	9600	9600~115200	
Data bits	8	7,8	
Parity	Even	Even, Odd, None	
Stop bits	1	1,2	
PLC sta. no.	1	0-255	

Online simulator	YES	Broadcast command	YES
Extend address mode	YES		

PLC Setting:

Communication mode	Modbus RTU protocol
--------------------	---------------------

Device Address:



Bit/Word	Device type	Format	Range	Memo
B	%M	DDDDD	0 ~ 65535	Output bit
B	1x	DDDDD	0 ~ 65535	Input bit (read only)
B	3x_Bit	DDDDDdd	0 ~ 6553515	Input Register bit (read only)
B	4x_Bit	DDDDDdd	0 ~ 6553515	Output Register bit
B	0x_multi_coils	DDDDD	0 ~ 65535	Write multiple coils
W	3x	DDDDD	0 ~ 65535	Input Register (read only)
W	%MW	DDDDD	0 ~ 65535	Output Register
DW	5x	DDDDD	0 ~ 65535	4x double word swap
W	6x	DDDDD	0 ~ 65535	4x single word write

Wiring Diagram:





The following represents the view of HMI & PLC.

RS232



eMT3000 series

COM1 RS232 9P D-Sub Female	COM3 RS232 9P D-Sub Female		RS232 9P D-Sub Female
2 RX	8 RX		2 B-
3 TX	7 TX		1 A+
5 GND	5 GND		5 DTP
			

MT6000/8000 series except MT6050i/MT8050i

COM1 RS232 9P D-Sub Female	COM2 RS232 9P D-Sub Female	COM3 RS232 9P D-Sub Male	RS232 9P D-Sub Female
2 RX	6 RX	8 RX	3 TX
3 TX	4 TX	7 TX	2 RX
5 GND	5 GND	5 GND	5 GND
			



MT6050i/MT8050i

COM1 RS232 9P D-Sub Female			RS232 9P D-Sub Female
9 RX			3 TX
6 TX			2 RX
5 GND			5 GND
			



The following represents the view of HMI & PLC.

9P D-Sub to 8P Mini-DIN : RS485 2W



eMT3000 series

COM1 RS485 2W 9P D-Sub Male	COM3 RS485 2W 9P D-Sub Male		RS485 2W 8P Mini-DIN Male
1 RX-	6 Data-		2 B-
2 RX+	9 Data+		1 A+
5 GND	5 GND		5 DTP
			7 GND
			

MT6000/8000 series except MT6050i/MT8050i

COM1 RS485 2W 9P D-Sub Male	COM3 RS485 2W 9P D-Sub Male		RS485 2W 8P Mini-DIN Male
1 RX-	6 Data-		2 B-
2 RX+	9 Data+		1 A+
5 GND	5 GND		5 DTP
			7 GND
			



MT6050i/MT8050i

COM1 RS485 2W 9P D-Sub Female	COM3 RS485 2W 9P D-Sub Female		RS485 2W 8P Mini-DIN Male
1 RX-	7 Data-		2 B-
2 RX+	8 Data+		1 A+
5 GND	5 GND		5 DTP
			7 GND
			



The following represents the view of HMI & PLC.

9P D-Sub to Terminal : RS485 2W



eMT3000 series

COM1 RS485 2W 9P D-Sub Male	COM3 RS485 2W 9P D-Sub Male		RS485 2W 3P Terminal
1 RX-	6 Data-		B-
2 RX+	9 Data+		A+
5 GND	5 GND		GND
			

MT6000/8000 series except MT6050i/MT8050i

COM1 RS485 2W 9P D-Sub Male	COM3 RS485 2W 9P D-Sub Male		RS485 2W 3P Terminal
1 RX-	6 Data-		B-
2 RX+	9 Data+		A+
5 GND	5 GND		GND
			

MT6050i/MT8050i

COM1 RS485 2W 9P D-Sub Female	COM3 RS485 2W 9P D-Sub Female		RS485 2W 3P Terminal
1 RX-	7 Data-		B-
2 RX+	8 Data+		A+
5 GND	5 GND		GND
			

Driver Version:

Version	Date	Description
V1.30	Aug/26/2009	

Schneider MODBUS TCP/IP

Supported Series : Schneider Modbus RTU TCP/IP Device.

Website: <http://www.schleicher-electronic.com>

HMI Setting:

Parameters	Recommended	Options	Notes
PLC type	Schneider MODBUS TCP/IP		
PLC I/F	Ethernet		
Port no.	502		
PLC sta. no.	1	0~255	

Device Address:

Bit/Word	Device type	Format	Range	Memo
B	%M	DDDDD	0 ~ 65535	Input bit
B	1x	DDDDD	0 ~ 65535	Output bit
B	3x_Bit	DDDDDdd	0 ~ 6553515	Input Register bit (read only)
B	4x_Bit	DDDDDdd	0 ~ 6553515	Output Register bit
B	6x_Bit	DDDDDdd	0 ~ 6553515	Output Register bit
B	0x_multi_coils	DDDDD	0 ~ 65535	Write multiple coils
W	3x	DDDDD	0 ~ 65535	Input Register
W	%MW	DDDDD	0 ~ 65535	Output Register
DW	5x	DDDDD	0 ~ 65535	4x double word swap
W	6x	DDDDD	0 ~ 65535	4x single word write

Wiring Diagram:

Direct connect (crossover cable):

HMI RJ45 Male	Wire Color	PLC RJ45 Male
1 TX+	White/Orange	3 RX+
2 TX-	Orange	6 RX-
3 RX+	White/Green	1 TX+
4 BD4+	Blue	4 BD4+
5 BD4-	White/Blue	5 BD4-
6 RX-	Green	2 TX-
7 BD3+	White/Brown	7 BD3+
8 BD3-	Brown	8 BD3-



Through a hub:

HMI RJ45 Male	Wire Color	PLC RJ45 Male
1 TX+	White/Orange	1 TX+
2 TX-	Orange	2 TX-
3 RX+	White/Green	3 RX+
4 BD4+	Blue	4 BD4+
5 BD4-	White/Blue	5 BD4-
6 RX-	Green	6 RX-
7 BD3+	White/Brown	7 BD3+
8 BD3-	Brown	8 BD3-



Driver Version:

Version	Date	Description
V1.40	Aug/27/2009	

Schneider UniTelway

Supported Series: Modicon TSX Micro&Nano&Neza series PLC.

Website: <http://www.modicon.com>

HMI Setting:

Parameters	Recommended	Options	Notes
PLC type	Schneider UniTelway		
PLC I/F	RS485 2W	RS232/RS485	
Baud rate	19200	9600~115200	
Data bits	8	7,8	Must set to 8 for this protocol
Parity	Odd	Even, Odd, None	
Stop bits	1	1, 2	
HMI sta. no.	5	1-8	
PLC sta. no.	0	0-3	

Online simulator	YES	Extend address mode	YES
Broadcast command	NO		

PLC Setting:

Communication mode	UniTelWay protocol, set PLC as master
--------------------	---------------------------------------

Device Address:

Bit/Word	Device type	Format	Range	Memo
B	S	DDDDD	0 ~ 32767	Internal relay
B	M	DDDDD	0 ~ 32767	Auxiliary relay
B	MW.B	DDDDDdd	0 ~ 3276715	Data register bit
W	MW	DDDDD	0 ~ 32767	Data register

Wiring Diagram:



The following represents the view of HMI & PLC.

TSX37-XX/TSX07-XX CPU : 9P D-Sub to 9P D-Sub



eMT3000 series

COM1 RS485 2W 9P D-Sub Male	COM3 RS485 2W 9P D-Sub Male		RS485 2W 8P Mini-DIN Male
1 RX-	6 Data-		2 D-
2 RX+	9 Data+		1 D+
5 GND	5 GND		7 GND
			

MT6000/8000 series except MT6050i/MT8050i

COM1 RS485 2W 9P D-Sub Male	COM3 RS485 2W 9P D-Sub Male		RS485 2W 8P Mini-DIN Male
1 RX-	6 Data-		2 D-
2 RX+	9 Data+		1 D+
5 GND	5 GND		7 GND
			

MT6050i/MT8050i

COM1 RS485 2W 9P D-Sub Female	COM3 RS485 2W 9P D-Sub Female		RS485 2W 8P Mini-DIN Male
1 RX-	7 Data-		2 D-
2 RX+	8 Data+		1 D+
5 GND	5 GND		7 GND
			

Driver Version:

Version	Date	Description
V1.30	Sep/24/2009	

SEW Movilink

Supported Series: SEW Eurodrive series, model MOVITRAC-07 inverter, MovitracB.

Website: <http://sg.sew-eurodrive.com/>

HMI Setting:

Parameters	Recommended	Options	Notes
PLC type	SEW Movilink		
PLC I/F	RS485 2W		
Baud rate	9600		
Data bits	8		
Parity	Even		
Stop bits	1		
PLC sta. no.	0	0~255	

Device Address:



Bit/Word	Device type	Format	Range	Memo
B	INDEX_Bit	DDDDDDDDdd	0 ~ 2552500031	
W	INDEX	DDDDDDDD	0 ~ 25525000	

- The MOVITRAC-07 doesn't support Sub index(other series may support), please input 000.
- When input D and d, the correct format : Sub index 15, Index 8359, Format is 01508359.



Wiring Diagram:

The following represents the view of HMI & PLC.



eMT3000 series

COM1 RS485 2W 9P D-Sub Male	COM3 RS485 2W 9P D-Sub Male		Movitrac-07 RS485 2W
1 RX-	6 Data-		D- (Green)
2 RX+	9 Data+		D+ (Red)
5 GND	5 GND		
			

MT6000/8000 series except MT6050i/MT8050i

COM1 RS485 2W 9P D-Sub Male	COM3 RS485 2W 9P D-Sub Male		Movitrac-07 RS485 2W
1 RX-	6 Data-		D- (Green)
2 RX+	9 Data+		D+ (Red)
5 GND	5 GND		
			

MT6050i/MT8050i

COM1 RS485 2W 9P D-Sub Female	COM3 RS485 2W 9P D-Sub Female		Movitrac-07 RS485 2W
1 RX-	7 Data-		D- (Green)
2 RX+	8 Data+		D+ (Red)
5 GND	5 GND		
			

Driver Version:

Version	Date	Description
V1.31	Jun/25/2010	

SEW MOVITRAC LTE

Website : <http://www.seweurodrive.com/index.php>

HMI Setting:

Parameters	Recommended	Options	Notes
PLC type	SEW MOVITRAC LTE		
PLC I/F	RS-485 2W		
Baud rate	115200		
Data bits	8		
Parity	None		
Stop bits	1		
PLC sta. no.	1		

Online simulator	YES	Extend address mode	NO
------------------	-----	---------------------	----

Device Address:

Bit/Word	Device type	Format	Range	Memo
W	P-1	D	0 ~ 1	Max. speed limit
W	P-2	D	0 ~ 1	Min. speed limit
W	P-3	D	0 ~ 1	Acceleration ramp time
W	P-4	D	0 ~ 1	Deceleration ramp time
W	P-5	D	0 ~ 1	Stop mode select
W	P-6	D	0 ~ 1	Energy optimizer
W	P-7	D	0 ~ 1	Motor rated voltage
W	P-8	D	0 ~ 1	Motor rated current
W	P-9	D	0 ~ 1	Motor rated frequency
W	P-10	D	0 ~ 1	Motor rated speed
W	P-11	D	0 ~ 1	Voltage boost
W	P-12	D	0 ~ 1	Terminal / Keypad control
W	P-13	D	0 ~ 1	Trip log
W	P-14	D	0 ~ 1	Extended menu access code
W	P-15	D	0 ~ 1	Digital input function set
W	P-16	D	0 ~ 1	Analog input V / mA
W	P-17	D	0 ~ 1	Output switching frequency

Bit/Word	Device type	Format	Range	Memo
W	P-18	D	0 ~ 1	User relay output select
W	P-19	D	0 ~ 1	User relay output limit
W	P-20	D	0 ~ 1	Preset speed 1
W	P-21	D	0 ~ 1	Preset speed 2
W	P-22	D	0 ~ 1	Preset speed 3
W	P-23	D	0 ~ 1	Preset speed 4
W	P-24	D	0 ~ 1	Deceleration ramp time 2
W	P-25	D	0 ~ 1	Analog output function select
W	P-26	D	0 ~ 1	Skip frequency hysteris band
W	P-27	D	0 ~ 1	Skip frequency
W	P-28	D	0 ~ 1	V/F characteristic adjustment voltage
W	P-29	D	0 ~ 1	V/F characteristic adjustment frequency
W	P-30	D	0 ~ 1	Terminal mode restart function
W	P-31	D	0 ~ 1	Keypad mode restart function
W	P-32	D	0 ~ 1	DC injection enable / duration
W	P-33	D	0 ~ 1	Spin start
W	P-34	D	0 ~ 1	Brake chopper enable
W	P-35	D	0 ~ 1	Analog input scaling factor
W	P-36	D	0 ~ 1	Comms address; SBus enable/baudrate select; Trip enable / delay
W	P-37	D	0 ~ 1	Access code definition
W	P-38	D	0 ~ 1	Parameter access lock
W	P-39	D	0 ~ 1	Analog input off-set
W	P-40	D	0 ~ 1	Display speed scaling factor
W	P-00-01	D	0 ~ 1	Analog input 1 value
W	P-00-02	D	0 ~ 1	Analog input 2 value
W	P-00-03	D	0 ~ 1	Speed reference input
W	P-00-04	D	0 ~ 1	Digital input status
W	P-00-05	D	0 ~ 1	Reserved
W	P-00-06	D	0 ~ 1	Reserved
W	P-00-07	D	0 ~ 1	Applied motor voltage
W	P-00-08	D	0 ~ 1	DC bus voltage log
W	P-00-09	D	0 ~ 1	Heatsink temperature
W	P-00-10	D	0 ~ 1	Hours run meter
W	P-00-11	D	0 ~ 1	Run time since last trip (1)
W	P-00-12	D	0 ~ 1	Run time since last trip (2)
W	P-00-13	D	0 ~ 1	Run time since last disable



Bit/Word	Device type	Format	Range	Memo
W	P-00-14	D	0 ~ 1	Reserved
W	P-00-15	D	0 ~ 1	DC bus voltage log
W	P-00-16	D	0 ~ 1	Thermistor temperature log
W	P-00-17	D	0 ~ 1	Motor current
W	P-00-18	D	0 ~ 1	Software ID,IO and motor control
W	P-00-19	D	0 ~ 1	Drive serial number
W	P-00-20	D	0 ~ 1	Drive identifier

P-00-01 ~ P-00-20 read only.



Wiring Diagram:

The following represents the view of HMI & PLC.



eMT3000 series

COM1 RS485 2W 9P D-Sub Male	COM3 RS485 2W 9P D-Sub Male		PLC RS485 2W 8P RJ45 Male
1 RX-	6 Data-		4 -
2 RX+	9 Data+		5 +
5 GND	5 GND		
			

MT6000/8000 series except MT6050i/MT8050i

COM1 RS485 2W 9P D-Sub Male	COM3 RS485 2W 9P D-Sub Male		PLC RS485 2W 8P RJ45 Male
1 RX-	6 Data-		4 -
2 RX+	9 Data+		5 +
5 GND	5 GND		
			

MT6050i/MT8050i

COM1 RS485 2W 9P D-Sub Female	COM3 RS485 2W 9P D-Sub Female		PLC RS485 2W 8P RJ45 Male
1 RX-	7 Data-		4 -
2 RX+	8 Data+		5 +
5 GND	5 GND		
			

Driver Version:

Version	Date	Description
V1.00	May/19/2011	Driver released.

SHIMADEN MR13/FP93

Supported Series: MR13, FP93 devices

Website: <http://www.shimaden.co.jp>

HMI Setting:

Parameters	Recommended	Options	Notes
PLC type	SHIMADEN MR13/FP93		
PLC I/F	RS485		
Baud rate	9600	1200-19200	
Data bits	7	7 or 8	
Parity	E	None/Even	
Stop bits	1	1	
PLC sta. no.	1	1~255	
Start Character Mode	Select 3 : @_:_CR	0, 1 : STX_ETX_CR 2 : STX_ETX_CR LF 3 : @_:_CR	For FP93, select 0,1
BCC Operation Method	Select 3 : XOR	0, 1 : Addition 2 : Addition +2's complement 3 : XOR 4 : None	

Note :

Address 018C is a communication control register, only when it is set to 1 can this register be allowed to write to other registers.

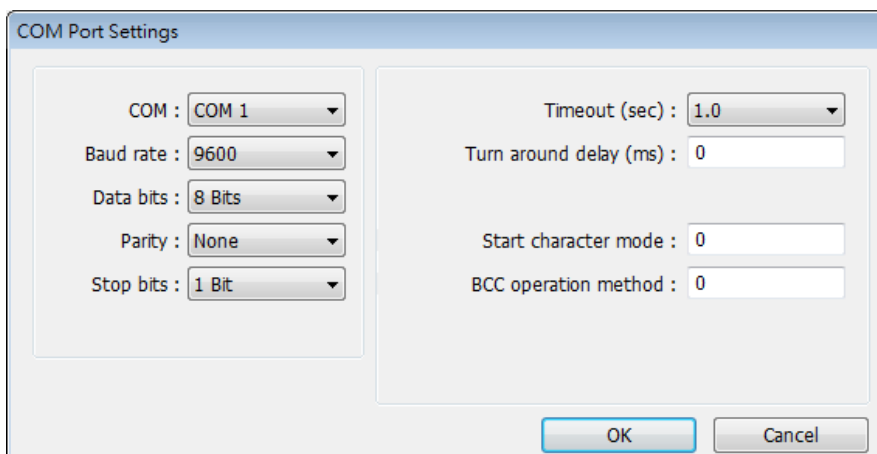



Device Address:

Bit/Word	Device type	Format	Range	Memo
W	Channel 1	HHHH	0 ~ ffff	Read/Write 1st Channel Register
W	Channel 2	HHHH	0 ~ ffff	Read/Write 2nd Channel Register
W	Channel 3	HHHH	0 ~ ffff	Read/Write 3rd Channel Register



Wiring Diagram:

The following represents the view of HMI & PLC.



eMT3000 series

COM1 RS485 2W 9P D-Sub Male	COM3 RS485 2W 9P D-Sub Male		MR13/FP93 RS485 2W Terminal
1 RX-	6 Data-		25 -
2 RX+	9 Data+		24 +
5 GND	5 GND		23 GND
			

MT6000/8000 series except MT6050i/MT8050i

COM1 RS485 2W 9P D-Sub Male	COM3 RS485 2W 9P D-Sub Male		MR13/FP93 RS485 2W Terminal
1 RX-	6 Data-		25 -
2 RX+	9 Data+		24 +
5 GND	5 GND		23 GND
			

MT6050i/MT8050i

COM1 RS485 2W 9P D-Sub Female	COM3 RS485 2W 9P D-Sub Female		MR13/FP93 RS485 2W Terminal
1 RX-	7 Data-		25 -
2 RX+	8 Data+		24 +
5 GND	5 GND		23 GND
			

MR13 Communication Parameter Settings

Data Address (hex)	Parameter	Details of Parameter	R /W
0100	PV Value	Within measuring range	R
0101	E_SV Execution SV Value	Within setting range	R
0102	OUT Control Output Value	Within range 0.0~100.0%	R
0103	Reserved		
0104	Action Flag	(See detailed explanation below.)	R
0105	Event Output Flag	(See detailed explanation below.)	R
0106	Reserved		
0107	Reserved		
0108	REM Value	Within setting range	R
0109	Reserved		
010A	Reserved		
010B	DI Input State Flag	(See detailed explanation below.)	R

Data Address (hex)	Parameter	Details of Parameter	R /W
0111	RANGE	Refer to the measuring range code list.	R
0112	Reserved		
0113	DP Decimal Point	Position of decimal point (0:Without decimal point 1:With decimal point)	R
0114	PV Sc_L Lower Limit	For Linear Input:-1999~9999 unit For Thermocouple, and RTD Input: Measuring range to be displayed.	R
0115	PV Sc_H Higher Limit		R

Data Address (hex)	Parameter	Details of Parameter	R/W
0120	E_PRG	Program Action Flag	R
0121	Reserved		

0122	Reserved		
0123	E_PRT	The number of execution patterns (When program is reset, value=7FFEh)	R
0124	E_STP	Execution step number (When program is reset, value=7FFEh)	R
0125	E_TIM	Remaining time of execution step (When program is reset, value=7FFEh)	R
0126	E_PID	Execution PID number (When program is reset, value=7FFEh)	R

Data Address (hex)	Parameter	Details of Parameter	R/W
0184	AT Auto Tuning	0:No execution 1:Execution	W

018C	Operation	0:Local 1:COM	W
------	-----------	------------------	---

0190	PROG RUN/RST Program Run/Reset	0 : RST, 1 : RUN (Writing is possible only in CH1)	W
------	-----------------------------------	---	---

0191	PROG HLD Program Hold	0 : Release, 1 : HLD (Writing is possible only in CH1)	W
------	--------------------------	---	---

0300	SV	Local SV Value, within set value limiter	R/W
------	----	--	-----

Data Address (hex)	Parameter	Details of Parameter	R/W
030A	SV Limt_L Lower Limit	Within measuring range, On condition that SV Limt_L<SV Limt_H	R/W
030B	SV Limt_h Higher Limit		

0314	REM SC_L	Within measuring range On condition that REM SC_L ≠ REM SC_H	R/W
0315	REM SC_H		
0316	REM Bias	Range: -1999~5000 unit	R/W
0317	REM Filt	Range: 0~100 seconds	R/W

031A	REM-CH	Remote channel assignment 0 : OFF , 1 : CH1 , 2 : CH2 , 3 : CH3	R/W
------	--------	--	-----

Data Address (hex)	Parameter	Details of Parameter	R/W
0320	SV Follow SW	CH2 & CH3 SV follow setting flag 1: Follow 0:No	R/W
0321	SV Follow	Follow type deviation SV set value: 1999~5000 unit	R/W

0400	FIX P	Control Output Proportional Baud Range: 0.0~999.9%(0.0:OFF)	R/W
0401	FIX I	Control Output Integral Time Range: 0~6000 Seconds (0.0:OFF)	R/W
0402	FIX D	Control Output Derivative Time Range 0~3600 Seconds (0.0:OFF)	R/W
0403	FIX MR	Manual Reset Range: -50.0~50.0%	R/W
0404	FIX DF	Hysteresis Range: 1~999 unit	R/W
0405	FIX OUT Limt_L	Control Output Lower Limit Output Limiter Range: 0.0~99.9%	R/W
0406	FIX OUT Limt_H	Control Output Higher Limit Output Limiter Range: 0.1~100.0%	R/W
0407	FIX SF	Control Output Target Value Function Range: OFF , 0.01~1.00	R/W
0408	Prog P1	PROG mode PB1 Range: 0.0~999.9% (0.0:OFF)	R/W
0409	Prog I1	PROG mode IT1 Range: 0~6000 seconds (0.0:OFF)	R/W
040A	Prog D1	PROG mode DT1 Range: 0~3600 seconds (0.0:OFF)	R/W

040B	Prog MR1	PROG mode MR1 Range: -50.0~50.0%	R/W
040C	Prog DF1	PROG mode DF1 Range: 1~999 unit	R/W
040D	Prog O_Lmt_L1	PROG mode lower limit side output limiter 1 Range: 0.0~99.9%	R/W
040E	Prog O_Lmt_H1	PROG mode higher limit side output limiter 1 Range: 0.1~100.0%	R/W
040F	Prog SF1	PROG mode target value function 1 Range: OFF,0.01~1.00	R/W
0410	Prog P2	PROG mode PB2 Range: 0.0~999.9% (0.0:OFF)	R/W
0411	Prog I2	PROG mode IT2 Range: 0~6000 seconds (0.0:OFF)	R/W
0412	Prog D2	PROG mode DT2 Range: 0~3600 seconds (0.0:OFF)	R/W
0413	Prog MR2	PROG mode MR2 Range: -50.0~50.0%	R/W
0414	Prog DF2	PROG mode DF2 Range: 1~999 unit	R/W
0415	Prog O_Lmt_L2	PROG mode lower limit side output limiter 2 Range: 0.0~99.9%	R/W
0416	Prog O_Lmt_H2	PROG mode higher limit side output limiter 2 Range: 0.1~100.0%	R/W
0417	Prog SF2	PROG mode target value function 2 Range: OFF,0.01~1.00	R/W
0418	Prog P3	PROG mode PB3 Range: 0.0~999.9% (0.0:OFF)	R/W
0419	Prog I3	PROG mode IT3 Range: 0~6000 seconds (0.0:OFF)	R/W
041A	Prog D3	PROG mode DT3 Range: 0~3600 seconds (0.0:OFF)	R/W
041B	Prog MR3	PROG mode MR3 Range: -50.0~50.0%	R/W
041C	Prog DF3	PROG mode DF3 Range: 1~999 unit	R/W
041D	Prog O_Lmt_L3	PROG mode lower limit side output	R/W

		limiter 3 Range: 0.0~99.9%	
041E	Prog O_Lmt_H3	PROG mode higher limit side output limiter 3 Range: 0.1~100.0%	R/W
041F	Prog SF3	PROG mode target value function 3 Range: OFF,0.01~1.00	R/W

0500	EV1_MODE	0:Not assigned 1:Higher limit deviation value 2:Lower limit deviation value 3:Out of range between higher & lower limits 4:Within range between higher & lower limits 5:Higher limit absolute value 6:Lower limit absolute value 7:Scaleover 8:Program RUN 9:Program END 10:Program STEP Only when Subaddress=EV1_CH.	R/W
0501	EV1 Set Point	1. Higher limit deviation value alarm: 0~1999 unit 2.Lower limit deviation value alarm: 0~-1999 unit 3.Out of range between higher & lower limits value alarm: 0~1999 unit 4.Within range between higher and lower limits value alarm: 0~1999 unit 5.Higher limit absolute value alarm: Within measuring range 6.Lower limit absolute value alarm: Within measuring range Only when Subaddress=EV1_CH.	R/W
0502	EV1 Diffrent	Alarm hysteresis 1~999 unit Only when Subaddress=EV1_CH.	R/W
0503	EV1 Inhibit	Alarm stand by 1~4 Only when Subaddress=EV1_CH.	R/W

0504	EV1 Delay	Alarm delay time 0~9999 seconds Only when Subaddress=EV1_CH.	R/W
0506	EV1_CH	Channel number setting 1:CH1, 2:CH2, 3:CH3	R/W
0510	EV2_MODE	0:Not assigned 1:Higher limit deviation value 2:Lower limit deviation value 3:Out of range between higher & lower limits 4:Within range between higher & lower limits 5:Higher limit absolute value 6:Lower limit absolute value 7:Scaleover 8:Program RUN 9:Program END 10:Program STEP Only when Subaddress=EV2_CH.	R/W
0511	EV2 Set Point	1. Higher limit deviation value alarm: 0~1999 unit 2.Lower limit deviation value alarm: 0~-1999 unit 3.Out of range between higher & lower limits value alarm: 0~1999 unit 4.Within range between higher and lower limits value alarm: 0~1999 unit 5.Higher limit absolute value alarm: Within measuring range 6.Lower limit absolute value alarm: Within measuring range Only when Subaddress=EV2_CH.	R/W
0512	EV2 Diffrent	Alarm hysteresis 1~999 unit Only when Subaddress=EV2_CH.	R/W
0513	EV2 Inhibit	Alarm stand by 1~4 Only when Subaddress=EV2_CH.	R/W
0514	EV2 Delay	Alarm delay time 0~9999 seconds	R/W

		Only when Subaddress=EV2_CH.	
0516	EV2_CH	Channel number setting 1:CH1, 2:CH2, 3:CH3	R/W
0520	EV3_MODE	0:Not assigned 1:Higher limit deviation value 2:Lower limit deviation value 3:Out of range between higher & lower limits 4:Within range between higher & lower limits 5:Higher limit absolute value 6:Lower limit absolute value 7:Scaleover 8:Program RUN 9:Program END 10:Program STEP Only when Subaddress=EV3_CH.	R/W
0521	EV3 Set Point	1. Higher limit deviation value alarm: 0~1999 unit 2.Lower limit deviation value alarm: 0~-1999 unit 3.Out of range between higher & lower limits value alarm: 0~1999 unit 4.Within range between higher and lower limits value alarm: 0~1999 unit 5.Higher limit absolute value alarm: Within measuring range 6.Lower limit absolute value alarm: Within measuring range Only when Subaddress=EV3_CH	R/W
0522	EV3 Diffrent	Alarm hysteresis 1~999 unit Only when Subaddress=EV3_CH.	R/W
0523	EV3 Inhibit	Alarm stand by 1~4 Only when Subaddress=EV3_CH.	R/W
0524	EV3 Delay	Alarm delay time 0~9999 seconds Only when Subaddress=EV3_CH.	R/W

0526	EV3_CH	Channel number setting 1:CH1, 2:CH2, 3:CH3	R/W
------	--------	---	-----

0580	DI	DI setting flag 0:NON 1:FLW 2:RUN 3:HLD 4:ADV	R/W
------	----	---	-----

05B0	MEM	1:EEP Program Memory 0:RAM Random Memory	R/W
------	-----	---	-----

0600	Out Actn	Output characteristic setting flag 0:Rev Act. 1:Dir Act	R/W
------	----------	--	-----

0601	Out Cyc	Control output cycle (Unit:0.5 seconds) Range: 0.5~ 120.0 seconds	R/W
------	---------	---	-----

0602	Reserved		
------	----------	--	--

0603	SOFTSW	Soft start setting flag 0:OFF 1:ON	
------	--------	---------------------------------------	--

0610	AT Point	AT pointer Range: 0~5000 unit	R/W
------	----------	-------------------------------	-----

0611	Key Lock	0:OFF 1:LOCK1 2:LOCK2 3:LOCK3	R/W
------	----------	----------------------------------	-----

- When Out_Cyc is written, writing data is adjusted to 0.5 sec as one unit.
- The write command lock by keylock is the same as the screen lock. (Refer to the manual of the instrument.)
- If there is a change in EV1_CH, EV2_CH, EV3_CH, the related parameters are initialized.

0701	PV Bias	PV bias Range: -1999~1999 unit	R/W
------	---------	--------------------------------	-----

0702	PV Filt	PV filter Range: 0~100 seconds	R/W
------	---------	--------------------------------	-----

0710	PFLW	Setting of CH2, CH3 PV input follow 0:OFF 1:ON	R/W
------	------	---	-----

0711	CH_P	Selection of CH2, CH3 PV display or not 0-0 Window 0: Without 1: With	R/W
------	------	--	-----

0800	FP_MOD	Selection between FIX and PROG 0:FIX 1:PROG (Writing possible only in CH1)	R/W
0801	PV_ST	Setting of PV start 0:OFF 1:ON (Writing possible only in CH1)	R/W

0882	STP	The number of steps 1~9 (Writing possible only in CH1)	R/W
0883	RPT	The number of execution repetitions 1 ~9999 (Writing possible only in CH1)	R/W
0884	ST_SV	Start SV (Writing possible only in CH1)	R/W

- For CH1, PFLW (window 1~30), CH_P (window1-29) display- - - .The read value is: 7FFEh, To a write command, error (0BH) is returned.

08A0	Step1 SV	Step No. 1 SV Value (Writing possible only in CH1)	R/W
08A1	Step1 Time	Step No. 1 Step Time (Writing possible only in CH1)	R/W
08A2	Step1 PID No	Step No. 1 PID No.	R/W
08A3	Reserved		
08A4	Step2 SV	Step No. 2 SV Value (Writing possible only in CH1)	R/W
08A5	Step2 Time	Step No. 2 Step Time (Writing possible only in CH1)	R/W
08A6	Step2 PID No	Step No. 2 PID No.	R/W
08A7	Reserved		
08A8	Step3 SV	Step No. 3 SV Value (Writing possible only in CH1)	R/W
08A9	Step3 Time	Step No. 3 Step Time (Writing possible only in CH1)	R/W
08AA	Step3 PID No	Step No. 3 PID No.	R/W
08AB	Reserved		
08AC	Step4 SV	Step No. 4 SV Value (Writing possible only in CH1)	R/W
08AD	Step4 Time	Step No. 4 Step Time	R/W

		(Writing possible only in CH1)	
08AE	Step4 PID No	Step No. 4 PID No.	R/W
08AF	Reserved		
08B0	Step5 SV	Step No. 5 SV Value (Writing possible only in CH1)	R/W
08B1	Step5 Time	Step No. 5 Step Time (Writing possible only in CH1)	R/W
08B2	Step5 PID No	Step No. 5 PID No.	R/W
08B3	Reserved		
08B4	Step6 SV	Step No. 6 SV Value (Writing possible only in CH1)	R/W
08B5	Step6 Time	Step No. 6 Step Time (Writing possible only in CH1)	R/W
08B6	Step6 PID No	Step No. 6 PID No.	R/W
08B7	Reserved		
08B8	Step7 SV	Step No. 7 SV Value (Writing possible only in CH1)	R/W
08B9	Step7 Time	Step No. 7 Step Time (Writing possible only in CH1)	R/W
08BA	Step7 PID No	Step No. 7 PID No.	R/W
08BB	Reserved		
08BC	Step8 SV	Step No. 8 SV Value (Writing possible only in CH1)	R/W
08BD	Step8 Time	Step No. 8 Step Time (Writing possible only in CH1)	R/W
08BE	Step8 PID No	Step No. 8 PID No.	R/W
08BF	Reserved		
08C0	Step9 SV	Step No. 9 SV Value (Writing possible only in CH1)	R/W
08C1	Step9 Time	Step No. 9 Step Time (Writing possible only in CH1)	R/W
08C2	Step9 PID No	Step No. 9 PID No.	R/W

Driver Version:

Version	Date	Description
V1.20	Apr/08/2011	

SHJ-A

HMI Setting:

Parameters	Recommended	Options	Notes
PLC type	SHJ-A		
PLC I/F	RS485 2W		
Baud rate	9600		
Data bits	8		
Parity	None		
Stop bits	1		
PLC sta. no.	0		



Device Address:

Bit/Word	Device type	Format	Range	Memo
W	Word	DD	0 ~ 89	



Wiring Diagram:

The following represents the view of HMI & PLC.



eMT3000 series

COM1 RS485 2W 9P D-Sub Male	COM3 RS485 2W 9P D-Sub Male		RS485 terminal
1 RX-	6 Data-		D-
2 RX+	9 Data+		D+
5 GND	5 GND		
			

MT6000/8000 series except MT6050i/MT8050i

COM1 RS485 2W 9P D-Sub Male	COM3 RS485 2W 9P D-Sub Male		RS485 terminal
1 RX-	6 Data-		D-
2 RX+	9 Data+		D+
5 GND	5 GND		
			

MT6050i/MT8050i

COM1 RS485 2W 9P D-Sub Female	COM3 RS485 2W 9P D-Sub Female		RS485 terminal
1 RX-	7 Data-		D-
2 RX+	8 Data+		D+
5 GND	5 GND		
			

Driver Version:

Version	Date	Description
V1.00	Oct/18/2011	Driver released.

SICK FLEXI SOFT

HMI Setting:

Parameters	Recommended	Options	Notes
PLC type	SICK FLEXI SOFT		
PLC I/F	RS232		
Baud rate	115200	9600,19200,3840 0,57600,115200	
Data bits	8		
Parity	None		
Stop bits	1		
PLC sta. no.	0		



Device Address:

Bit/Word	Device type	Format	Range	Memo
B	I	DDo	0 ~ 967	Input
B	Q	DDo	0 ~ 487	Output
B	Logic result	DDo	0 ~ 327	Logic Result
B	RS-232	DDo	0 ~ 327	RS-232





Wiring Diagram:

The following represents the view of HMI & PLC.



eMT3000 series

COM1 RS232 9P D-Sub Female	COM3 RS232 9P D-Sub Female		FLEXI soft CPU0 Port0 4P Mini-DIN Male
2 RX	8 RX		3 TX
3 TX	7 TX		2 RX
5 GND	5 GND		4 GND
			

MT6000/8000 series except MT6050i/MT8050i

COM1 RS232 9P D-Sub Female	COM2 RS232 9P D-Sub Female	COM3 RS232 9P D-Sub Male	FLEXI soft CPU0 Port0 4P Mini-DIN Male
2 RX	6 RX	8 RX	3 TX
3 TX	4 TX	7 TX	2 RX
5 GND	5 GND	5 GND	4 GND
			

MT6050i/MT8050i

COM1 RS232 9P D-Sub Female			FLEXI soft CPU0 Port0 4P Mini-DIN Male
9 RX			3 TX
6 TX			2 RX
5 GND			4 GND
			

Driver Version:

Version	Date	Description
V1.00	Apr/6/2011	Driver released.

Siemens LOGO (Ethernet)

Supported Series: Siemens LOGO! 0BA7

Website: <http://www.siemens.com/entry/cc/en/>

HMI Setting:

Parameters	Recommended	Options	Notes
PLC type	Siemens S7/200 (Ethernet)		
PLC I/F	Ethernet		
Port no.	102		
PLC sta. no.	1	1~99	
Local TSAP	1000		Must be greater than 1000
Remote TSAP	2100		Range:2000~2700

★ For TSAP settings please refer to PLC Setting below.

PLC Setting:

Siemens LOGO! multi connection setting requires LOGO! Soft Comfort software to set PLC to identify the connected devices. The following introduces LOGO! Soft Comfort settings.

Step 1. Tools -> Ethernet Connections

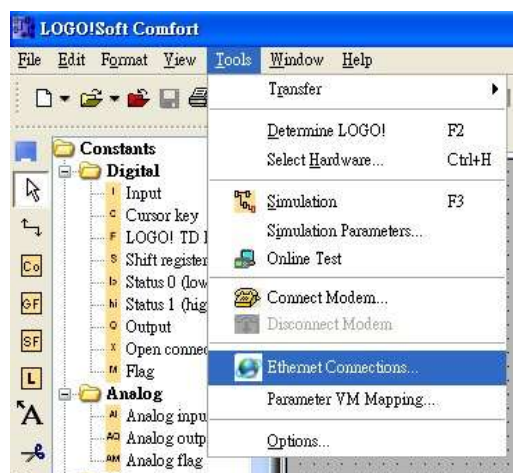

Step 2. Right click on "Ethernet Connections" and click "Add connections" to add a connection, up to eight connections are allowed.

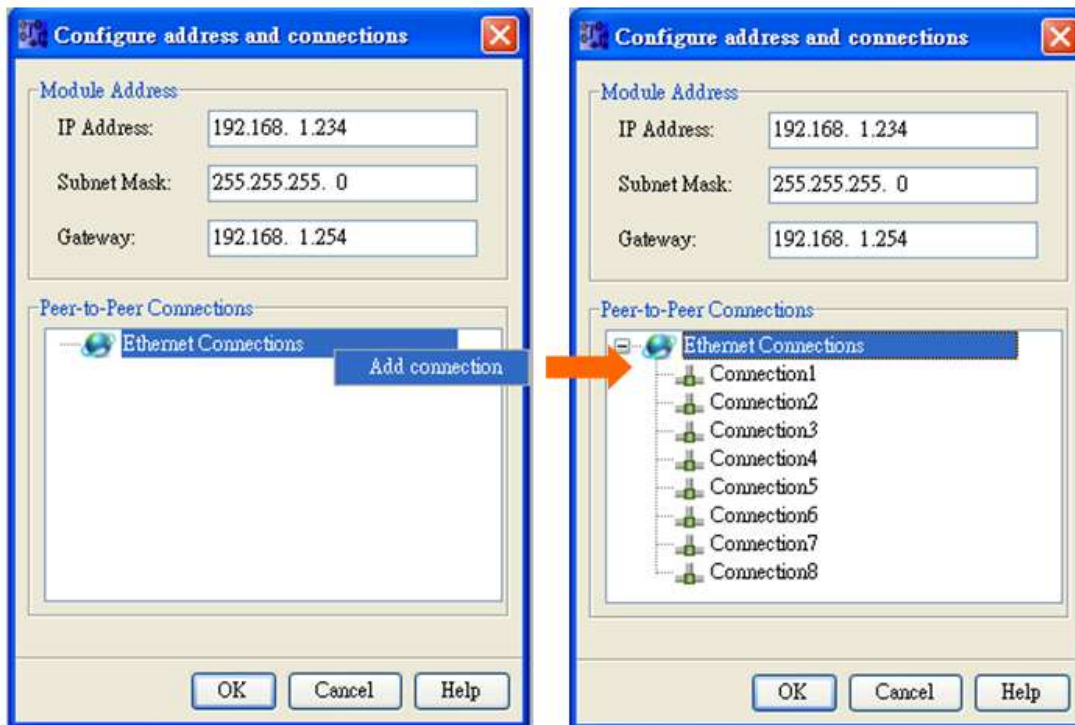

Step 3. Setting Server

- I. Double click on Connection1, then select "Server Connection".
- II. Local TSAP is system default and can't be modified. Tick "Accept all connection requests" to connect to any IP.
- III. Remote TSAP set to "10.00".
- IV. Connection 2~8 can all be set as above.

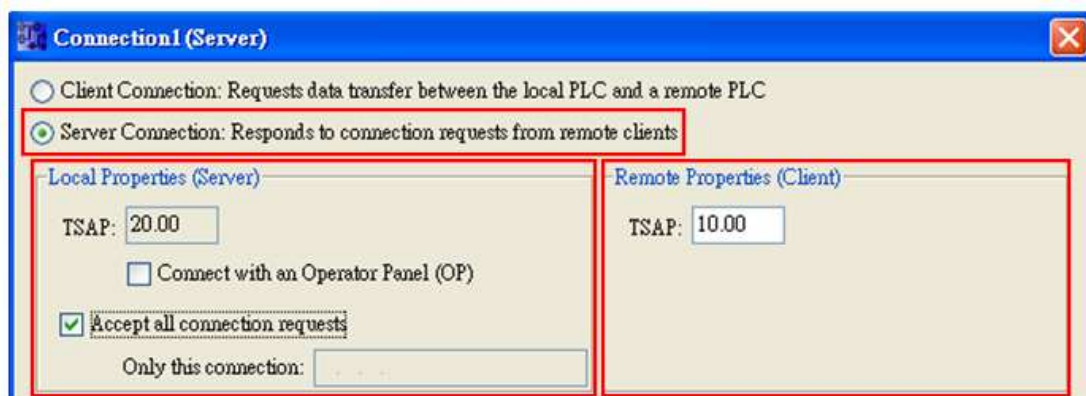

Note: The value of Local TSAP and Remote TSAP must be set oppositely in EasyBuilder for communication.

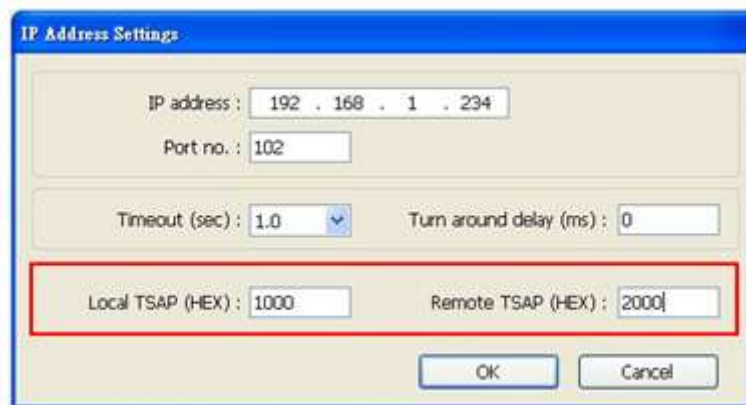

Step 4. Complete settings, download connection to Siemens LOGO!

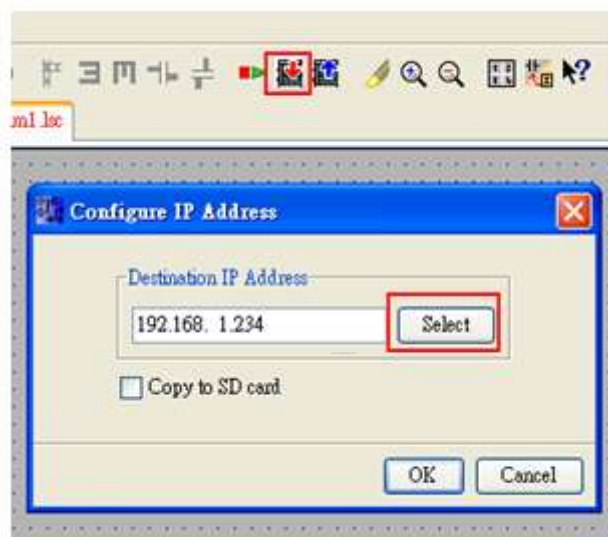

Device Address:

Bit/Word	Device type	Format	Range	Memo
B	I	DD	1~24	Read Only
B	Q	DD	1~16	
B	M	DD	1~27	
B	V	DDDDo	0~1023	VW_Bit
W	AI	D	1~8	
W	AQ	D	1~2	
W	AM	DD	1~16	
W	VW	DDDD	0~1023	See Table 1 Address Mapping

Table 1 Address Mapping

I	VW	Q	VW	M	VW	AI	VW	AQ	VW	AM	VW
I1	V923.0	Q1	V942.0	M1	V948.0	AI1	VW926	AQ1	VW944	AM1	VW952
I2	V923.1	Q2	V942.1	M2	V948.1	AI2	VW928	AQ2	VW946	AM2	VW954
I3	V923.2	Q3	V942.2	M3	V948.2	AI3	VW930			AM3	VW956
I4	V923.3	Q4	V942.3	M4	V948.3	AI4	VW932			AM4	VW958
I5	V923.4	Q5	V942.4	M5	V948.4	AI5	VW934			AM5	VW960
I6	V923.5	Q6	V942.5	M6	V948.5	AI6	VW936			AM6	VW962
I7	V923.6	Q7	V942.6	M7	V948.6	AI7	VW938			AM7	VW964
I8	V923.7	Q8	V942.7	M8	V948.7	AI8	VW940			AM8	VW966
I9	V924.0	Q9	V943.0	M9	V949.0					AM9	VW968
I10	V924.1	Q10	V943.1	M10	V949.1					AM10	VW970
I11	V924.2	Q11	V943.2	M11	V949.2					AM11	VW972
I12	V924.3	Q12	V943.3	M12	V949.3					AM12	VW974
I13	V924.4	Q13	V943.4	M13	V949.4					AM13	VW976
I14	V924.5	Q14	V943.5	M14	V949.5					AM14	VW978
I15	V924.6	Q15	V943.6	M15	V949.6					AM15	VW980
I16	V924.7	Q16	V943.7	M16	V949.7					AM16	VW982
I17	V925.0			M17	V950.0						
I18	V925.1			M18	V950.1						
I19	V925.2			M19	V950.2						
I20	V925.3			M20	V950.3						
I21	V925.4			M21	V950.4						
I22	V925.5			M22	V950.5						
I23	V925.6			M23	V950.6						
I24	V925.7			M24	V950.7						
				M25	V951.0						
				M26	V951.1						
				M27	V951.2						

Wiring Diagram:

Direct connect (crossover cable):

HMI RJ45 Male	Wire Color	PLC RJ45 Male
1 TX+	White/Orange	3 RX+
2 TX-	Orange	6 RX-
3 RX+	White/Green	1 TX+
4 BD4+	Blue	4 BD4+
5 BD4-	White/Blue	5 BD4-
6 RX-	Green	2 TX-
7 BD3+	White/Brown	7 BD3+
8 BD3-	Brown	8 BD3-



Through a hub:

HMI RJ45 Male	Wire Color	PLC RJ45 Male
1 TX+	White/Orange	1 TX+
2 TX-	Orange	2 TX-
3 RX+	White/Green	3 RX+
4 BD4+	Blue	4 BD4+
5 BD4-	White/Blue	5 BD4-
6 RX-	Green	6 RX-
7 BD3+	White/Brown	7 BD3+
8 BD3-	Brown	8 BD3-



Driver Version:

Version	Date	Description
V1.00	DEC/7/2011	Driver released.

Siemens S7-1200 (Ethernet)

Supported Series: Siemens S7-1200 series Ethernet.

Website: <http://www.siemens.com/entry/cc/en/>

HMI Setting:

Parameters	Recommended	Options	Notes
PLC type	SIEMENS S7-1200 (Ethernet)	Siemens S7-400 (Ethernet)	
PLC I/F	Ethernet	Ethernet	
Port no.	102	102	
PLC sta. no.	2	2	
Rack	-	0	
CPU slot	-	1	

On-line simulator	Yes	Multi-PLC connect	Yes
-------------------	-----	-------------------	-----

PLC Setting:

1. In S7-1200 program software create PLC program and tag and then download to PLC.
2. Select Go offline, EasyBuilder will connect to PLC and get tag data. In PLC type select "SIEMENS S7-1200 (Ethernet)".

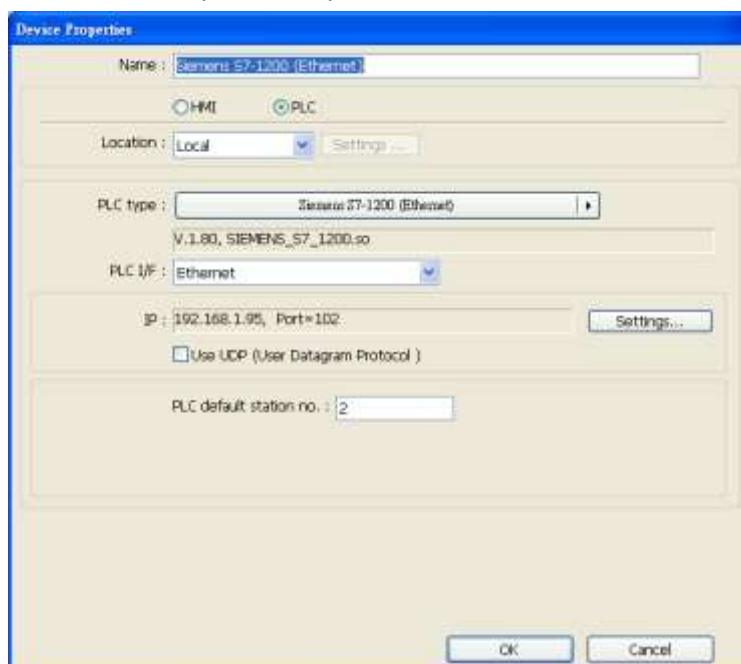

3. Click “Settings...”, input PLC IP address.

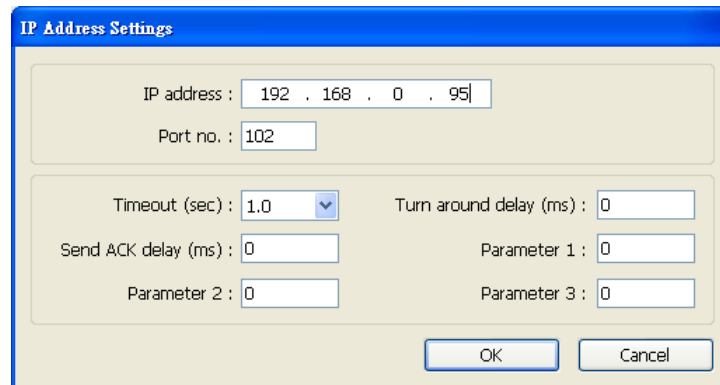

The dialog box titled "IP Address Settings" contains the following fields:

- IP address : 192 . 168 . 0 . 95
- Port no. : 102
- Timeout (sec) : 1.0 (dropdown menu)
- Turn around delay (ms) : 0
- Send ACK delay (ms) : 0
- Parameter 1 : 0
- Parameter 2 : 0
- Parameter 3 : 0

Buttons: OK, Cancel

4. Check the PLC that is not connected to any PC. Click “Get tag info...”.

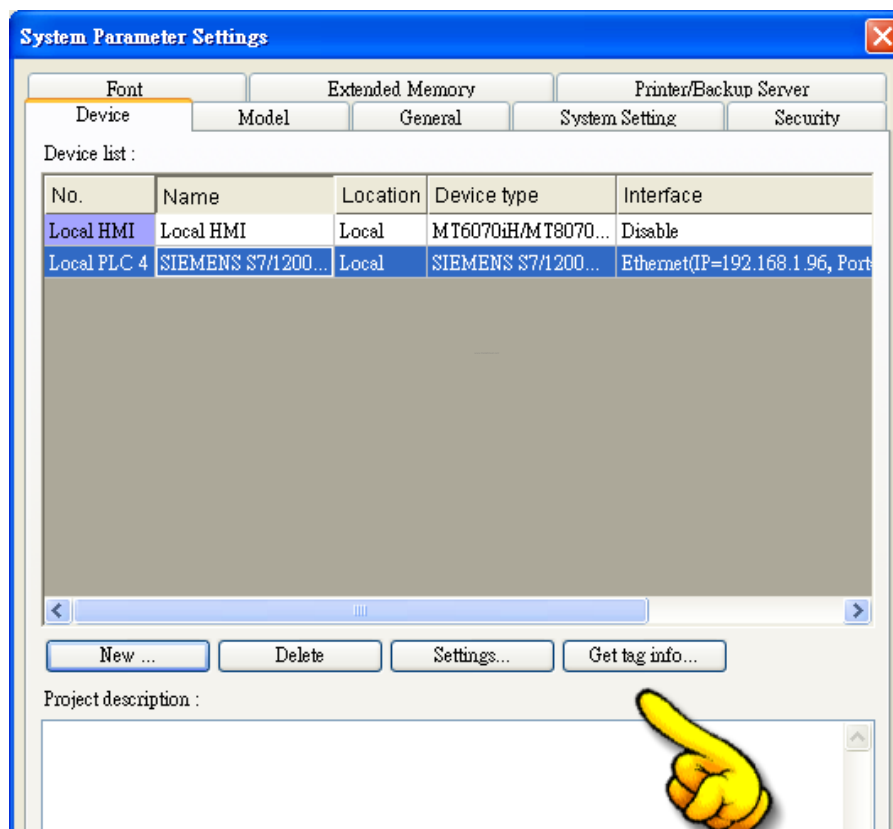

The dialog box titled "System Parameter Settings" has several tabs: Font, Extended Memory, Printer/Backup Server, Device, Model, General, System Setting, and Security. The "Device" tab is active, showing a "Device list" table.

No.	Name	Location	Device type	Interface
Local HMI	Local HMI	Local	MT6070iH/MT8070...	Disable
Local PLC 4	SIEMENS S7/1200...	Local	SIEMENS S7/1200...	Ethernet(IP=192.168.1.96, Port

Buttons: New ..., Delete, Settings..., Get tag info...

Project description :

A yellow hand icon is pointing to the "Get tag info..." button.

5. If the software used is a version later than TIA Portal V11 , SP2, a dialog of FunctionBlock directory will be shown, users have to define the mapping from FB to DB in this directory then click “Check OK” . The tag information will be gained and a successful message is shown.

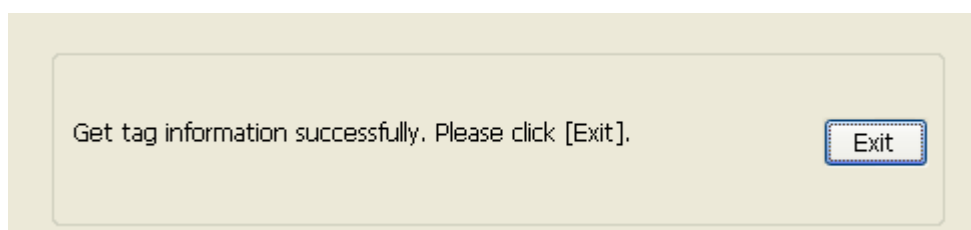
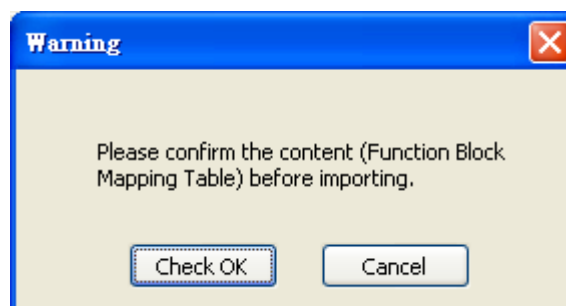
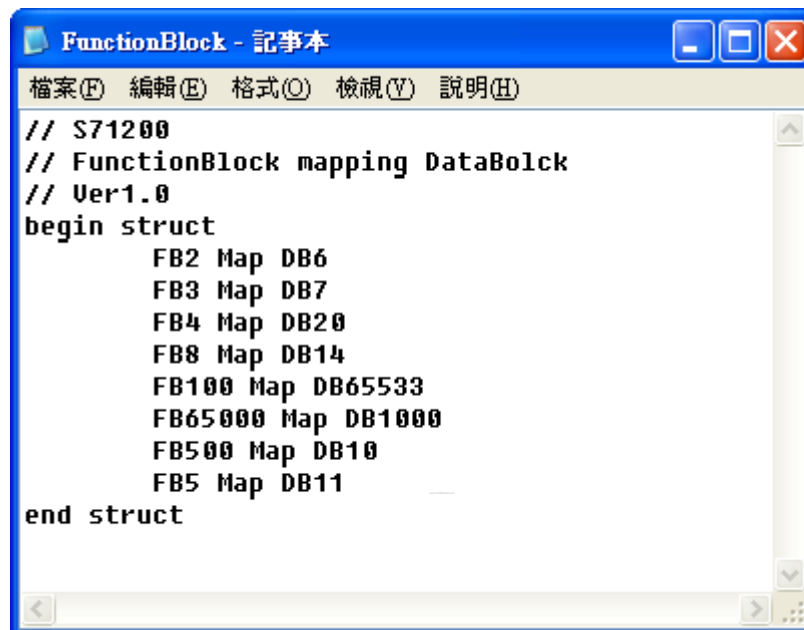

6. Create an object and click read address “Setting...”

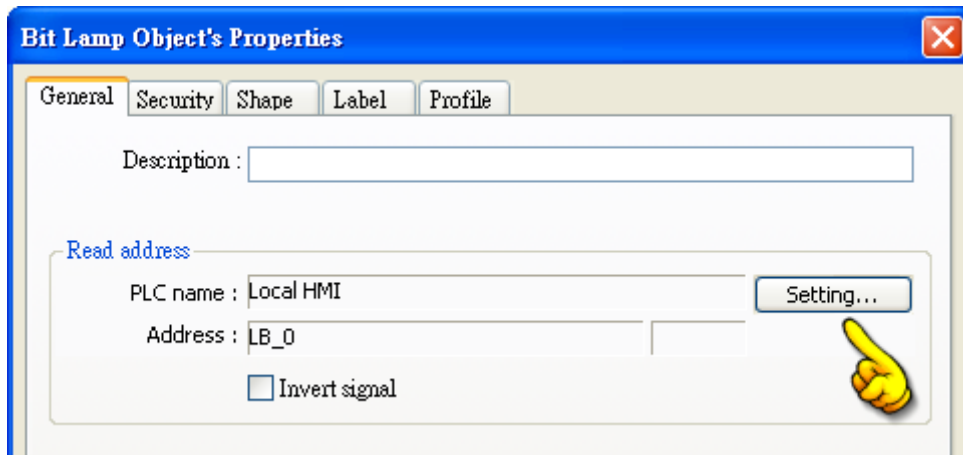

7. In PLC name select S7-1200 then click Tag.

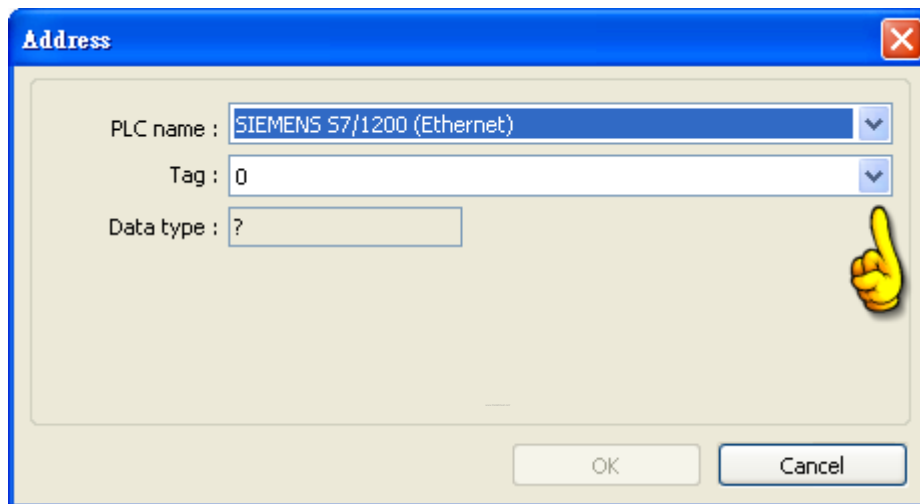

8. Select PLC tag.

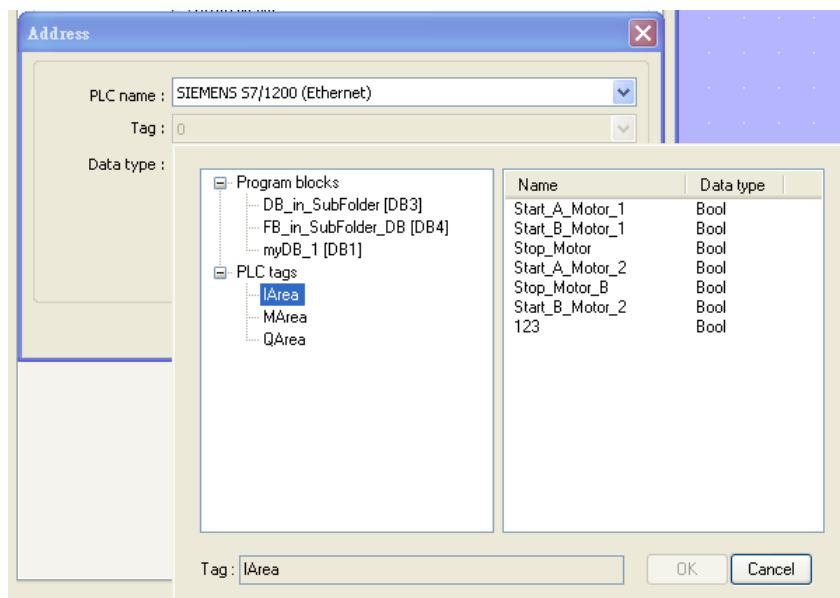

Support Device Type:

S7-1200 data type	EasyBuilder data format	Memo
Bool	bit	
Byte	16-bit BCD, Hex, Binary, Unsigned	8-bit
SInt	16-bit BCD, Hex, Binary, Signed	8-bit
USInt	16-bit BCD, Hex, Binary, Unsigned	8-bit
Word	16-bit BCD, Hex, Binary, Unsigned	16-bit
Int	16-bit BCD, Hex, Binary, Signed	16-bit
UInt	16-bit BCD, Hex, Binary, Unsigned	16-bit
DWord	32-bit BCD, Hex, Binary, Unsigned	32-bit
DInt	32-bit BCD, Hex, Binary, Signed	32-bit
Real	32-bit Float	32-bit
UDInt	32-bit BCD, Hex, Binary, Unsigned	32-bit
Array	Word array for ASCII input and ASCII display	Length=word

Wiring Diagram:

Direct connect (crossover cable):

HMI RJ45 Male	Wire Color	PLC RJ45 Male
1 TX+	White/Orange	3 RX+
2 TX-	Orange	6 RX-
3 RX+	White/Green	1 TX+
4 BD4+	Blue	4 BD4+
5 BD4-	White/Blue	5 BD4-
6 RX-	Green	2 TX-
7 BD3+	White/Brown	7 BD3+
8 BD3-	Brown	8 BD3-



Through a hub:

HMI RJ45 Male	Wire Color	PLC RJ45 Male
1 TX+	White/Orange	1 TX+
2 TX-	Orange	2 TX-
3 RX+	White/Green	3 RX+
4 BD4+	Blue	4 BD4+
5 BD4-	White/Blue	5 BD4-
6 RX-	Green	6 RX-
7 BD3+	White/Brown	7 BD3+
8 BD3-	Brown	8 BD3-



Driver Version:

Version	Date	Description
V1.70	Oct/7/2011	Add data type: Byte, SInt, UInt, UInt
V1.90	Apr/26/2012	Add data type: USInt

Siemens S7-200

Supported Series: Siemens S7-200 series PLC
(CPU212/214/215/216/221/222/224/226/226XM)

Website: <http://www.siemens.com/entry/cc/en/>

HMI Setting:

Parameters	Recommended	Options	Notes
PLC type	SIEMENS S7-200		
PLC I/F	RS485 2w	RS485 2w	
Baud rate	9600	9600, 19200, 187.5K	The HMI which has a sticker "MPI187.5" on the rear cover supports 187.5K
Data bits	8	7,8	
Parity	Even	Even, Odd, None	
Stop bits	1	1, 2	
PLC sta. no.	2	1 ~ 126	
Turn around delay (ms)	5	—	
Send ACK delay(ms)	30		

Online simulator	YES	Extend address mode	NO
Broadcast command	NO		

PLC Setting:

Communication mode	Set station number to 2
--------------------	-------------------------

Device Address:

Bit/Word	Device type	Format	Range	Memo
B	I	DDDDo	0 ~ 40957	Input (I)
B	Q	DDDDo	0 ~ 40957	Output (O)
B	M	DDDDo	0 ~ 40957	Bit Memory
B	VW_Bit	DDDDDo	0 ~ 102397	V Memory Bit Address
Byte	VB	DDDDD	0 ~ 10239	

Bit/Word	Device type	Format	Range	Memo
W	VW	DDDDD	0 ~ 10239	V Memory
W	VW_Odd	DDDDD	0 ~ 10239	V Memory
DW	VD	DDDDD	0 ~ 10239	V Memory Double Word
DW	VD_Odd	DDDDD	0 ~ 10239	V Memory Double Word
W	VW_String	DDDDD	0 ~ 10239	String
W	VW_String_Odd	DDDDD	0 ~ 10239	String
DW	VD_String	DDDDD	0 ~ 10239	String
DW	VD_String_Odd	DDDDD	0 ~ 10239	String
Byte	MB	DDDDD	0 ~ 10239	Byte Memory
W	MW	DDDDD	0 ~ 10239	Word Memory
DW	MD	DDDDD	0 ~ 10239	Word Memory
W	MW_Odd	DDDDD	0 ~ 10239	Word Memory
W	T	DDD	0 ~ 127	Timer
W	C	DDD	0 ~ 127	Counter

- Double word and floating point value must use VD device type.



Wiring Diagram:

The following represents the view of HMI & PLC.



eMT3000 series

COM1 RS485 2W 9P D-Sub Male	COM3 RS485 2W 9P D-Sub Male		RS485 2W 9P D-Sub Male
1 RX-	6 Data-		8 D-
2 RX+	9 Data+		3 D+
5 GND	5 GND		5 GND
			

MT6000/8000 series except MT6050i/MT8050i

COM1 RS485 2W 9P D-Sub Male	COM3 RS485 2W 9P D-Sub Male		RS485 2W 9P D-Sub Male
1 RX-	6 Data-		8 D-
2 RX+	9 Data+		3 D+
5 GND	5 GND		5 GND
			

MT6050i/MT8050i

COM1 RS485 2W 9P D-Sub Female	COM3 RS485 2W 9P D-Sub Female		RS485 2W 9P D-Sub Male
1 RX-	7 Data-		8 D-
2 RX+	8 Data+		3 D+
5 GND	5 GND		5 GND
			

Driver Version:

Version	Date	Description
V2.30	Aug/17/2009	
V2.40	Nov/1/2011	Add device type : MD

Siemens S7-200 (Ethernet)

Supported Series: Siemens S7/200 Ethernet Series PLC
(CPU212/214/215/216/221/222/224/226/226XM) with CP243-1 Ethernet module

Website: <http://www.siemens.com/entry/cc/en/>

HMI Setting:

Parameters	Recommended	Options	Notes
PLC type	SIEMENS S7-200 (Ethernet)		
PLC I/F	Ethernet		
Port no.	102		
PLC sta. no.	1	0-31	

PLC Setting:

S7/200 Ethernet Multi-Connection Settings

Step 1: Launching the Ethernet Wizard

1. In the Micro/WIN main menu, click **Tools / Ethernet Wizard**.

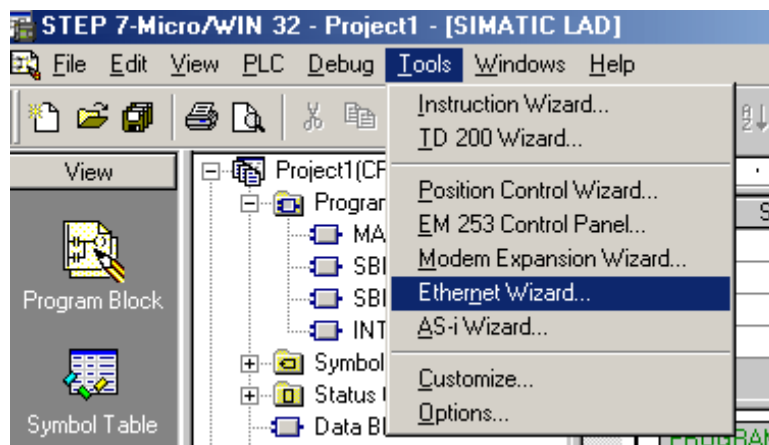

2. Then, click **Next**.

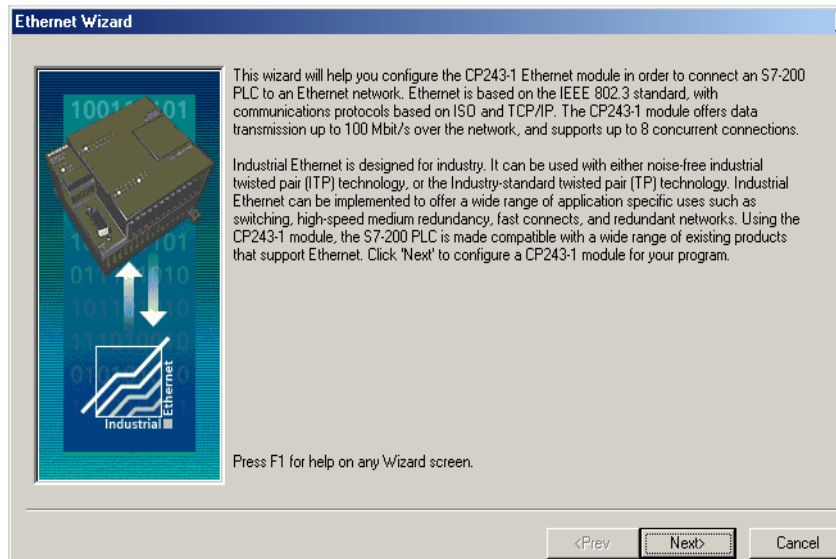

3. Click **Yes** to proceed.

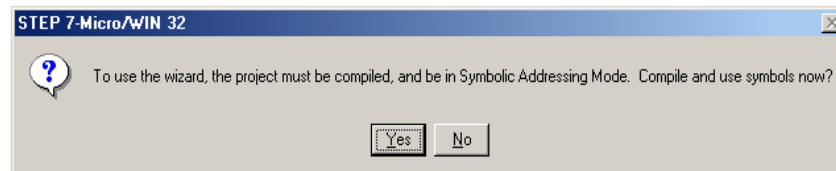

Step 2: Setting CP243-1 Module Position

1. Click **Read Modules**.

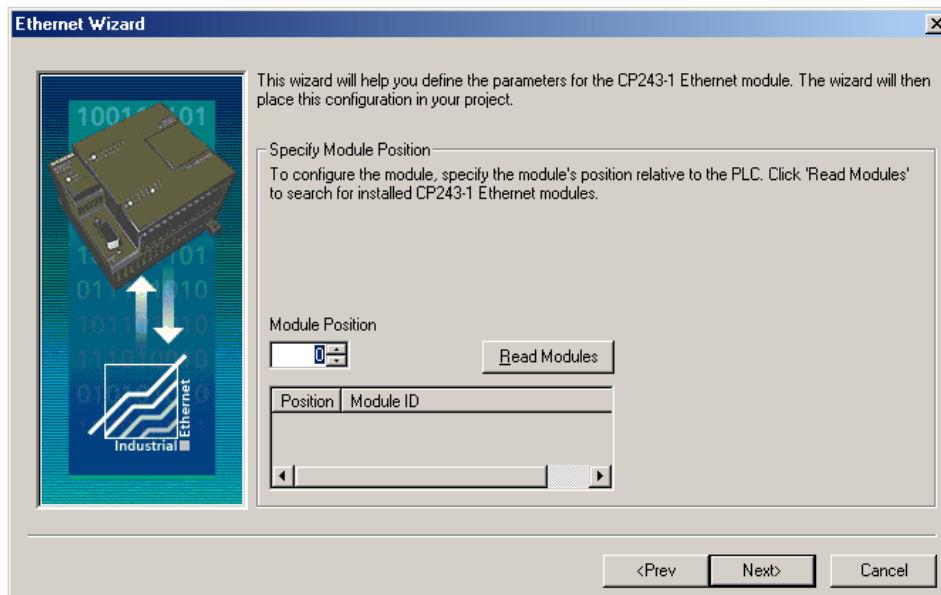

- To view the results of Read Modules, select the **Ethernet module**. Click **Next**.

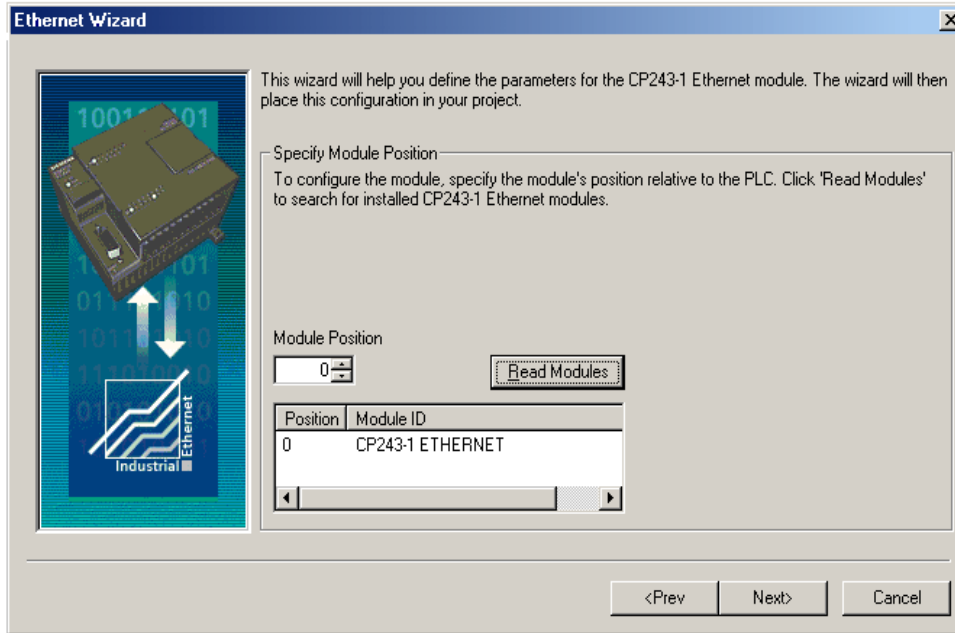

Step 3: Assigning Module Address

- Click **Next**.

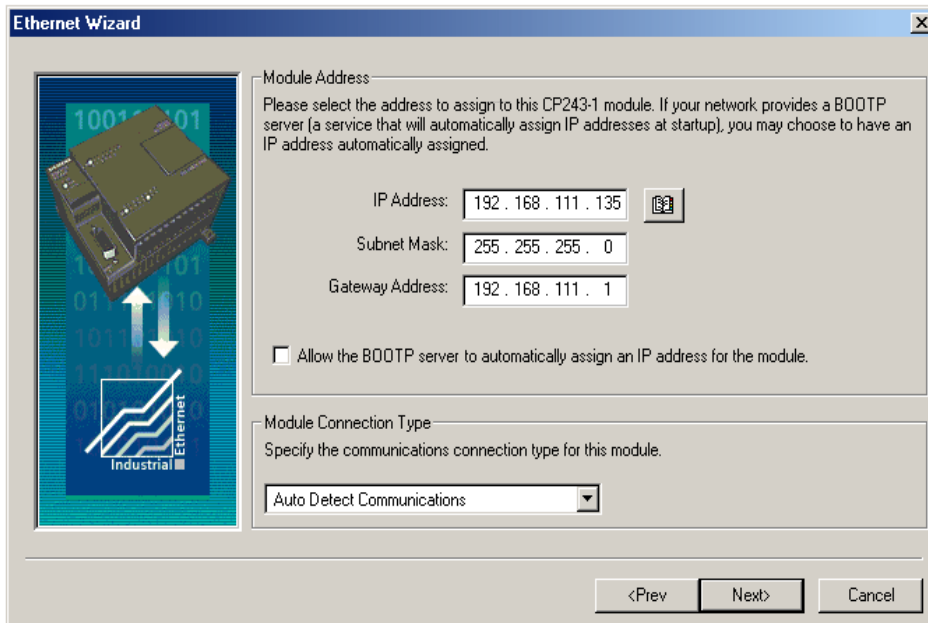

- Enter the number of desired available connections for this device. If 0 is entered, the only connection available will be the PG mode. The image below shows there are 4 connections for this module.

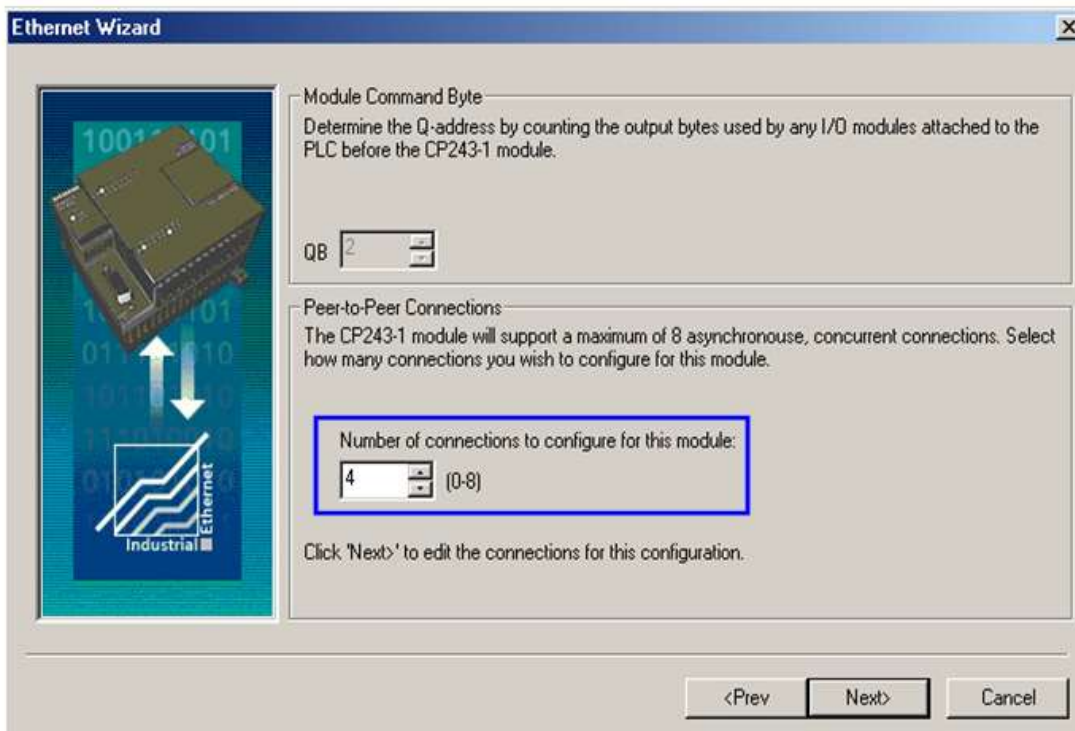

- Connection0 -> Select **This is a Server Connection....**
Notice the **Local TSAP** automatically incremented to **10.00**.

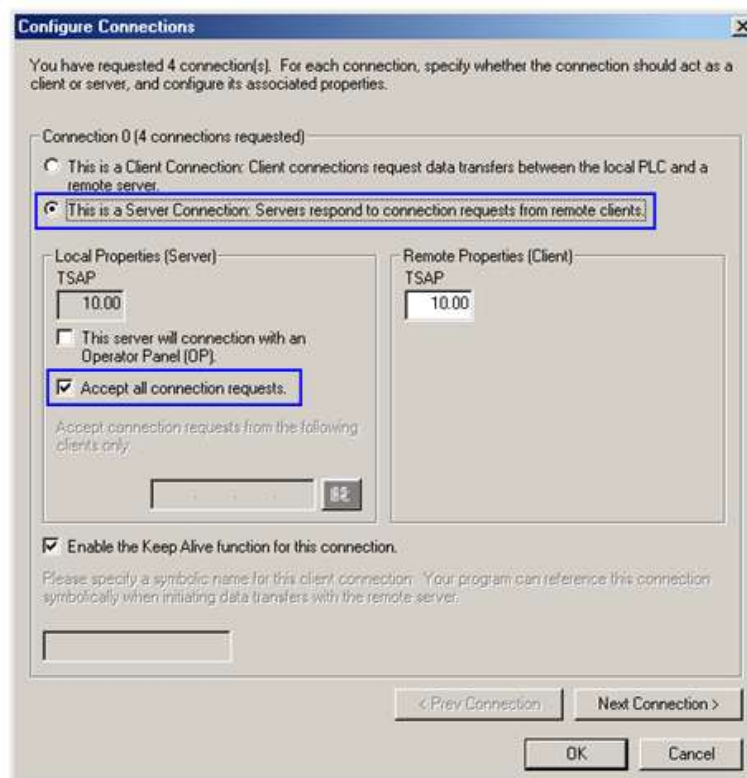

4. Connection1 › Select **This is a Server Connection....**

Notice the **Local TSAP** automatically incremented to **11.00**.

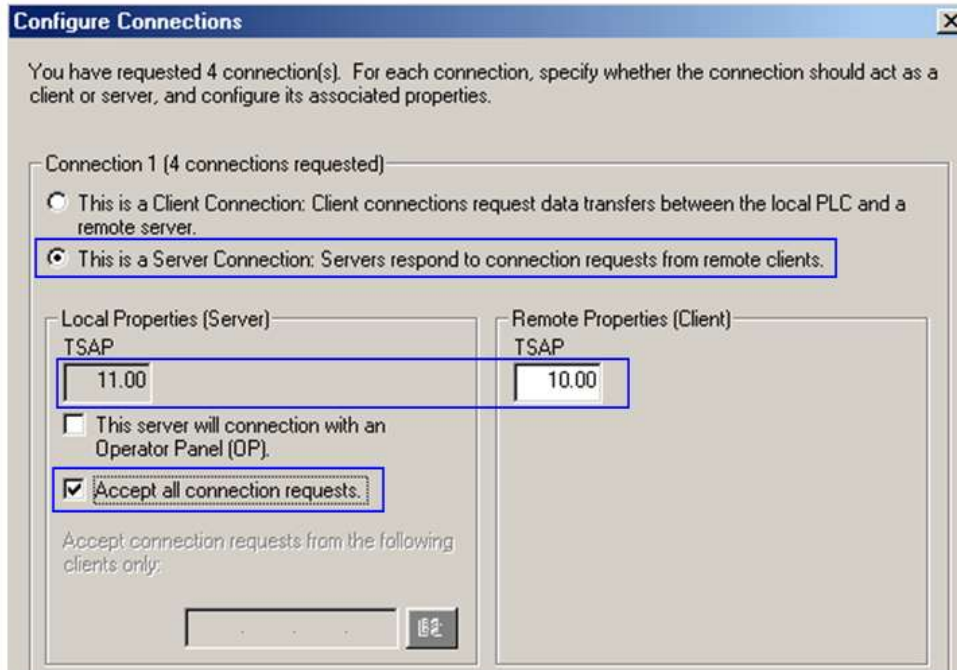

5. Upon completion of the settings above, set parameters in EasyBuilder. Set the value of Local TSAP here to the value of Remote TSAP in Micro/WIN and vice versa to realize multi-connection.

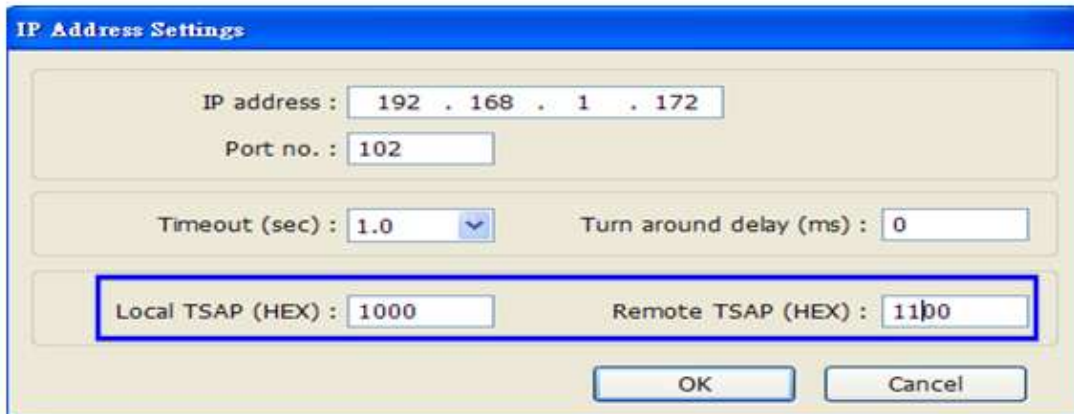

Device Address:

Bit/Word	Device type	Format	Range	Memo
B	I	DDDDo	0 ~ 40957	Input (I)
B	Q	DDDDo	0 ~ 40957	Output (O)
B	M	DDDDo	0 ~ 40957	Bit Memory
B	VW_Bit	DDDDDo	0 ~ 102397	V Memory Bit Address
W	VW	DDDDD	0 ~ 10239	V Memory
DW	VD	DDDDD	0 ~ 10239	V Memory Double Word
W	VW_String	DDDDD	0 ~ 10239	String
DW	VD_String	DDDDD	0 ~ 10239	String
DW	MD	DDDDD	0 ~ 10239	Word Memory

- Double word and floating point value must use VD device type.

Wiring Diagram:

Direct connect (crossover cable):

HMI RJ45 Male	Wire Color	PLC RJ45 Male
1 TX+	White/Orange	3 RX+
2 TX-	Orange	6 RX-
3 RX+	White/Green	1 TX+
4 BD4+	Blue	4 BD4+
5 BD4-	White/Blue	5 BD4-
6 RX-	Green	2 TX-
7 BD3+	White/Brown	7 BD3+
8 BD3-	Brown	8 BD3-



Through a hub:

HMI RJ45 Male	Wire Color	PLC RJ45 Male
1 TX+	White/Orange	1 TX+
2 TX-	Orange	2 TX-
3 RX+	White/Green	3 RX+
4 BD4+	Blue	4 BD4+
5 BD4-	White/Blue	5 BD4-
6 RX-	Green	6 RX-
7 BD3+	White/Brown	7 BD3+
8 BD3-	Brown	8 BD3-



Driver Version:

Version	Date	Description
V1.20	Dec/30/2008	
V1.40	Nov/15/2011	Add device type : MD

Siemens S7-200 (VD any address)

Supported Series: Siemens S7-200 series PLC
(CPU212/214/215/216/221/222/224/226/226XM)

Website: <http://www.siemens.com/entry/cc/en/>

HMI Setting:

Parameters	Recommended	Options	Notes
PLC type	Siemens S7-200 (VD any address)		
PLC I/F	RS485 2w	RS485 2w	
Baud rate	9600	9600, 19200, 187.5K	The HMI which has a sticker "MPI187.5" on the rear cover supports 187.5K
Data bits	8	7,8	
Parity	Even	Even, Odd, None	
Stop bits	1	1, 2	
PLC sta. no.	2	1 ~ 126	
Turn around delay (ms)	5	—	
Reserved 1	30		ACK delay time

Online simulator	YES	Extend address mode	NO
Broadcast command	NO		

PLC Setting:

Communication mode	Set station number to 2
--------------------	-------------------------

Device Address:

Bit/Word	Device type	Format	Range	Memo
B	I	DDDDo	0 ~ 40957	Input (I)
B	Q	DDDDo	0 ~ 40957	Output (O)
B	M	DDDDo	0 ~ 40957	Bit Memory
B	VW_Bit	DDDDDo	0 ~ 102397	V Memory Bit Address
W	VW	DDDDD	0 ~ 10239	V Memory



Bit/Word	Device type	Format	Range	Memo
DW	VD	DDDDD	0 ~ 10239	V Memory Double Word
W	VW_String	DDDDD	0 ~ 10239	String
DW	VD_String	DDDDD	0 ~ 10239	String
W	MW	DDDDD	0 ~ 10239	Word Memory
W	T	DDD	0 ~ 127	Timer
W	C	DDD	0 ~ 127	Counter
DW	MD	DDDDD	0 ~ 10239	Word Memory

- Double word and floating point value must use VD device type.
- VD register can set to any value, not necessarily a multiple of 4.



Wiring Diagram:

The following represents the view of HMI & PLC.



eMT3000 series

COM1 RS485 2W 9P D-Sub Male	COM3 RS485 2W 9P D-Sub Male		RS485 2W 9P D-Sub Male
1 RX-	6 Data-		8 D-
2 RX+	9 Data+		3 D+
5 GND	5 GND		5 GND
			

MT6000/8000 series except MT6050i/MT8050i

COM1 RS485 2W 9P D-Sub Male	COM3 RS485 2W 9P D-Sub Male		RS485 2W 9P D-Sub Male
1 RX-	6 Data-		8 D-
2 RX+	9 Data+		3 D+
5 GND	5 GND		5 GND
			

MT6050i/MT8050i

COM1 RS485 2W 9P D-Sub Female	COM3 RS485 2W 9P D-Sub Female		RS485 2W 9P D-Sub Male
1 RX-	7 Data-		8 D-
2 RX+	8 Data+		3 D+
5 GND	5 GND		5 GND
			

Driver Version:

Version	Date	Description
V1.20	Nov/16/2011	Add device type : MD

Siemens S7-200 PPI

Supported Series: Siemens S7-200 series PLC
(CPU212/214/215/216/221/222/224/226/226XM)

Website: <http://www.siemens.com/entry/cc/en/>

HMI Setting:

Parameters	Recommended	Options	Notes
PLC type	SIEMENS S7-200 PPI		
PLC I/F	RS485 2w	RS485 2w	
Baud rate	9600	9600, 19200, 187.5K	Only MT6000/8000V2 support baud rate 187.5 K
Data bits	8	7,8	
Parity	Even	Even, Odd, None	
Stop bits	1	1, 2	
Turn around delay (ms)	5		
ACK delay time (ms)	30		
PLC sta. no.	2	1 ~ 126	

Online simulator	YES	Extend address mode	YES
Broadcast command	NO		

PLC Setting:

PLC setting	PLC sta. no. can not be the same as HMI sta. no.
-------------	--

Device Address:

Bit/Word	Device type	Format	Range	Memo
B	I	DDDDo	0 ~ 40957	Input (I)
B	Q	DDDDo	0 ~ 40957	Output (O)
B	M	DDDDo	0 ~ 40957	Bit Memory
B	VW_Bit	DDDDDo	0 ~ 102397	V Memory Bit Address
Byte	VB	DDDDD	0 ~ 10239	
W	VW	DDDDD	0 ~ 10239	V Memory

Bit/Word	Device type	Format	Range	Memo
W	VW_Odd	DDDDD	0 ~ 10239	V Memory
DW	VD	DDDDD	0 ~ 10239	V Memory Double Word
DW	VD_Odd	DDDDD	0 ~ 10239	V Memory Double Word
W	VW_String	DDDDD	0 ~ 10239	String
W	VW_String_Odd	DDDDD	0 ~ 10239	String
DW	VD_String	DDDDD	0 ~ 10239	String
DW	VD_String_Odd	DDDDD	0 ~ 10239	String
Byte	MB	DDDDD	0 ~ 10239	Byte Memory
W	MW	DDDDD	0 ~ 10239	Word Memory
W	MW_Odd	DDDDD	0 ~ 10239	Word Memory
W	T	DDD	0 ~ 127	Timer
W	C	DDD	0 ~ 127	Counter
DW	MD	DDDDD	0 ~ 10239	Word Memory

- Double Word and floating point value must use VD device type.

Multi-HMIs-Multi-PLCs Communication Setting:



For S7-200 PLC, Multi-HMIs-Multi-PLCs communication can be achieved using S7/200 PPI driver, please refer to the settings below.

IN EasyBuilder COM Port Settings, two important parameters must be set:

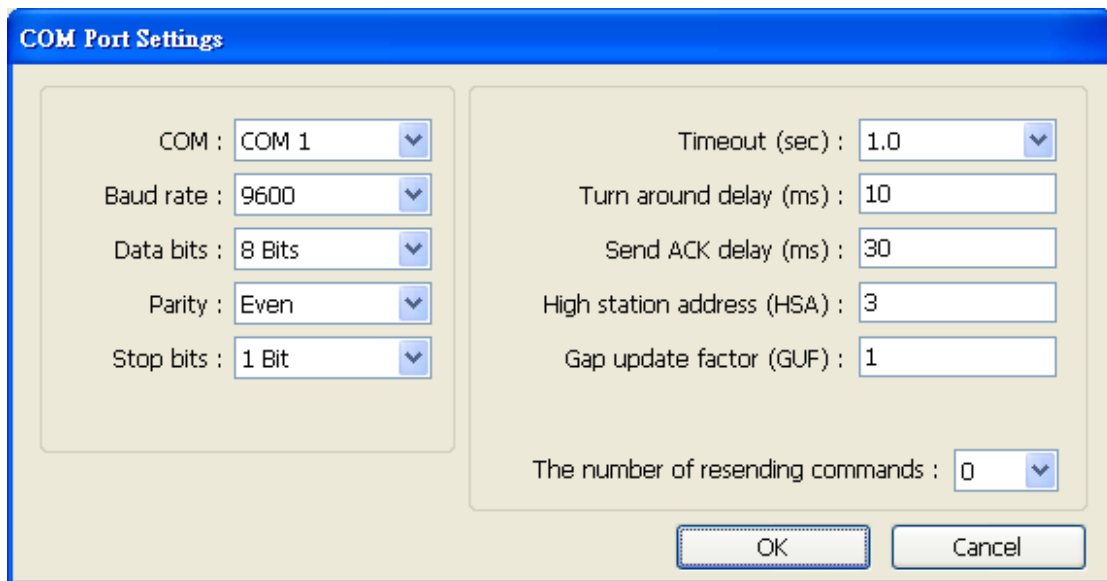

1. [High station address (HSA)]:

Setting Max. Station Number of HMI in PPI network.

For the effectiveness of system operation, it is highly recommended that the HMI station number starts from zero and go on sequentially. If there are 4 HMI in PPI network, set station no. from 0~3, and [High station address (HSA)] to 3.

Set HMI station number in [System Parameters] / [Model] / [HMI station no.]:

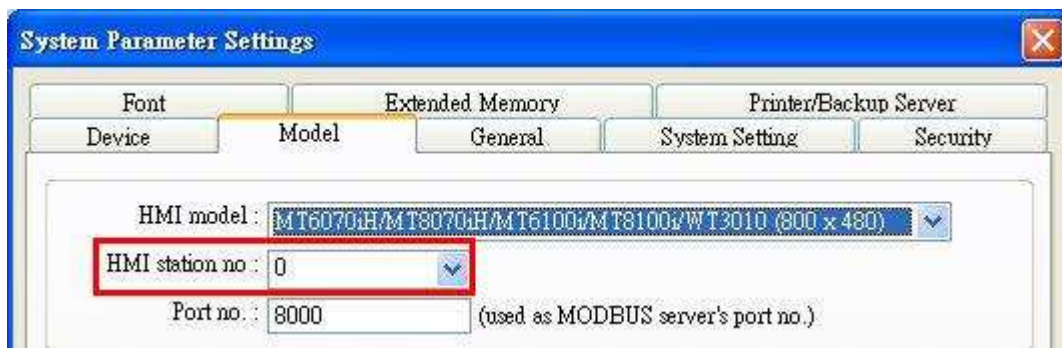

2. [Gap update factor(GUF)]:

The condition to pass a Token. In PPI network only HMI can hold a Token, PLC can only be controlled.

When the HMI that holds Token communicates with PLC for a number of times that equals to the value set here, HMI will pass the Token (control of PLC) to the next HMI. For example, if GUF is set to "1", HMI will pass the control of PLC to the next HMI when read or write the value in an address.

If GUF is set to a bigger value, the HMI that holds Token will control the PLC for a longer time and therefore the Token won't be passed to another HMI and cause failure in communicating with PLC.

A complete communication means HMI reads / writes PLC value for one time.



Note:

- HMI sta. no. can not be the same as PLC sta. no.
- Highly recommended that HMI sta. no. starts from 0 and go on sequentially for the effectiveness of operation.
- Available for EasyBuilder V4.50 and later.



Wiring Diagram:

The following represents the view of HMI & PLC.



eMT3000 series

COM1 RS485 2W 9P D-Sub Male	COM3 RS485 2W 9P D-Sub Male		RS485 2W 9P D-Sub Male
1 RX-	6 Data-		8 D-
2 RX+	9 Data+		3 D+
5 GND	5 GND		5 GND
			

MT6000/8000 series except MT6050i/MT8050i

COM1 RS485 2W 9P D-Sub Male	COM3 RS485 2W 9P D-Sub Male		RS485 2W 9P D-Sub Male
1 RX-	6 Data-		8 D-
2 RX+	9 Data+		3 D+
5 GND	5 GND		5 GND
			

MT6050i/MT8050i

COM1 RS485 2W 9P D-Sub Female	COM3 RS485 2W 9P D-Sub Female		RS485 2W 9P D-Sub Male
1 RX-	7 Data-		8 D-
2 RX+	8 Data+		3 D+
5 GND	5 GND		5 GND
			

Driver Version

Version	Date	Description
V1.00	Aug/15/2011	Driver released.
V1.10	Nov/17/2011	Add device type : MD

Siemens S7-300

Supported Series: Siemens S7-300 series PLC

Website: <http://www.siemens.com/entry/cc/en/>

HMI Setting:

Parameters	Recommended	Options	Notes
PLC type	SIEMENS S7-300		
PLC I/F	RS232		
Baud rate	19200	9600~187.5K	Must be same as the PLC setting. The HMI which has a sticker MPI187.5 on the rear cover supports 187.5K.
Data bits	8		
Parity	Odd		
Stop bits	1		
PLC sta. no.	2		Must be same as the PLC setting.

Device Address:

Bit/Word	Device type	Format	Range	Memo
B	I	DDDDo	0 ~ 40957	Input (I)
B	Q	DDDDo	0 ~ 40957	Output (O)
B	M	DDDDo	0 ~ 40957	Bit Memory
B	DBnBit	FFFFDDDDo	0 ~ 409681927	Data Register Bit
B	DB0Bit ~ DB99Bit	DDDDo	0 ~ 81927	
W	IW	DDDD	0 ~ 4095	Input (I)
W	QW	DDDD	0 ~ 4095	Output (O)
W	MW	DDDD	0 ~ 4095	Bit Memory
DW	MD	DDDD	0 ~ 4094	
Byte	MB	DDDD	0 ~ 4095	Bit Memory Byte
Byte	DBBn	FFFFDDDD	0 ~ 40968192	Data Register Byte
W	DBn	FFFFDDDD	0 ~ 40968192	Data Register (must be even)

Bit/Word	Device type	Format	Range	Memo
DW	DBDn	FFFFDDDD	0 ~ 40968192	Data Register Double Word (must be multiple of 4)
W	DBn_String	FFFFDDDD	0 ~ 40968192	Data Register Double Word (must be multiple of 4)
DW	DBDn_String	FFFFDDDD	0 ~ 40968192	Data Register Double Word (must be multiple of 4)
W	DB0-DB99	DDDD	0 ~ 8192	Data Register (must be even)

* Double word and floating point value must use DBDn device type.

How to Import Tag:

SIEMENS STEP 7 program allows building files of user-defined tag (*.dif file and *.AWL file), and import these files in EasyBuilder8000/EasyBuilderPro -> System Parameter Settings. The following describes how to build and import these two types of files.

1. Building *.dif File

- a. In “Symbols” create user-defined tag.

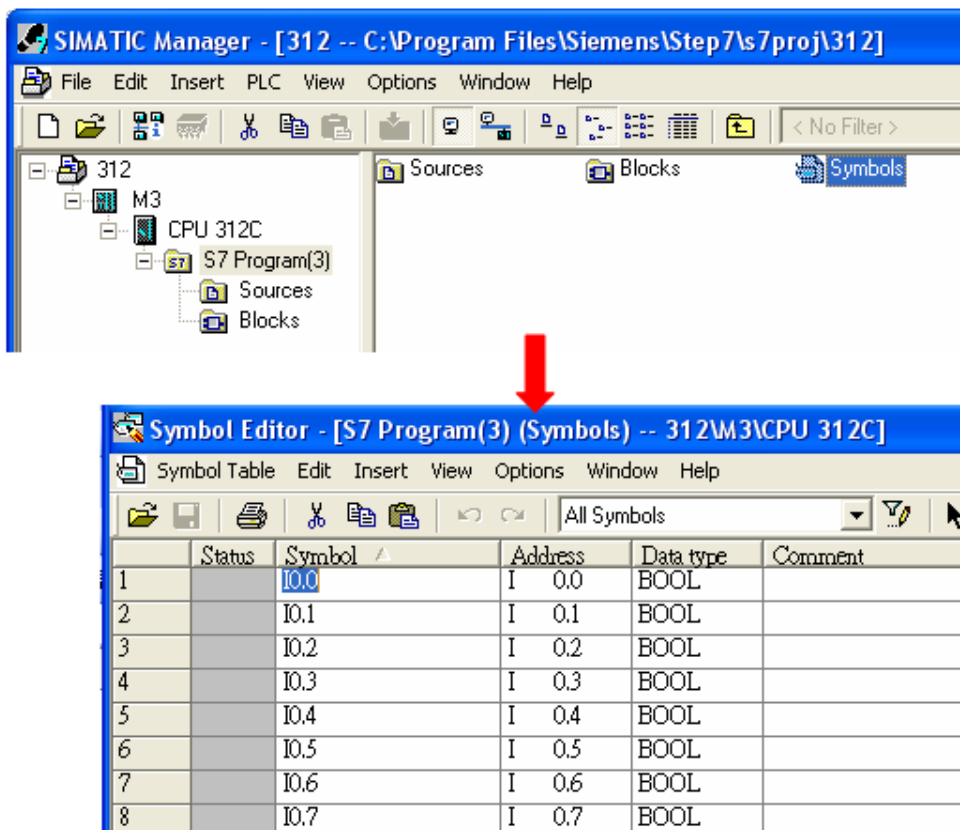

The screenshot shows the SIMATIC Manager interface. The left pane shows the project tree with '312' selected, containing 'M3', 'CPU 312C', and 'S7 Program(3)'. The right pane shows the 'Symbols' view. A red arrow points from the 'Symbols' view in the SIMATIC Manager to the 'Symbol Editor' window. The Symbol Editor window shows a table of symbols:

	Status	Symbol	Address	Data type	Comment
1		I0.0	I 0.0	BOOL	
2		I0.1	I 0.1	BOOL	
3		I0.2	I 0.2	BOOL	
4		I0.3	I 0.3	BOOL	
5		I0.4	I 0.4	BOOL	
6		I0.5	I 0.5	BOOL	
7		I0.6	I 0.6	BOOL	
8		I0.7	I 0.7	BOOL	

b. Click **Export** to export the edited file and click **Save**.

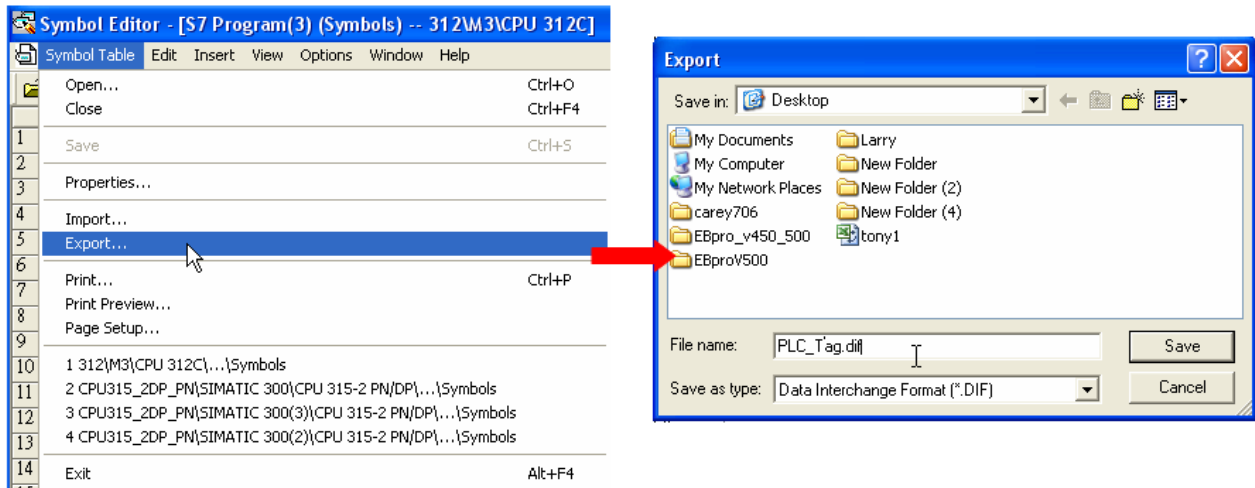

2. Building *.AWF File

a. In **Blocks** create items as shown below:

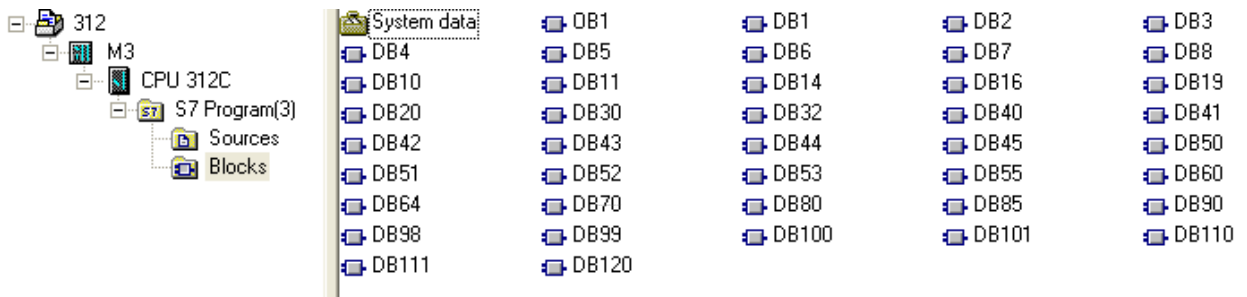

b. Open LAD/STL, FBD – Programming S7 Blocks, click **File -> Generate Source**.

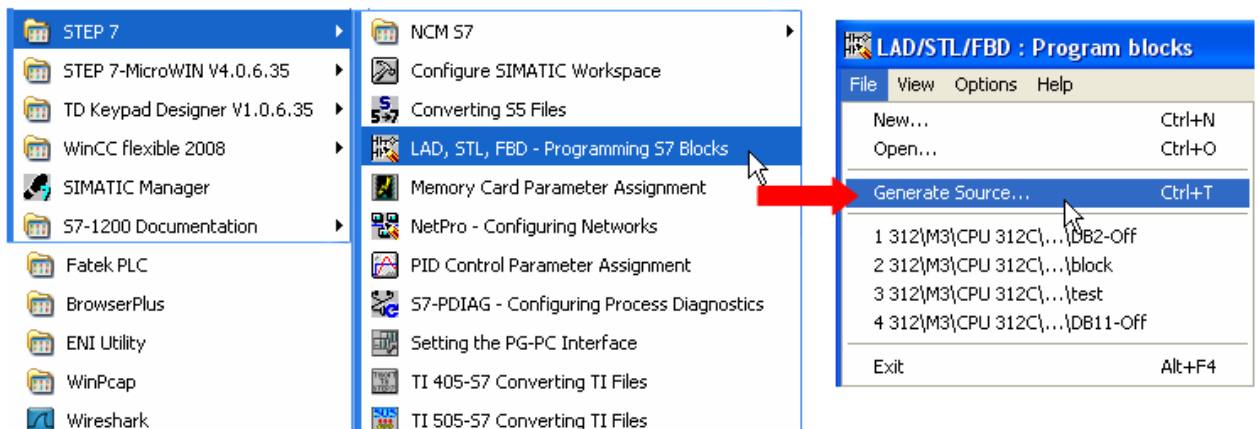

- c 、 Select **Sources** as storage path, specify the file name then click **OK**.

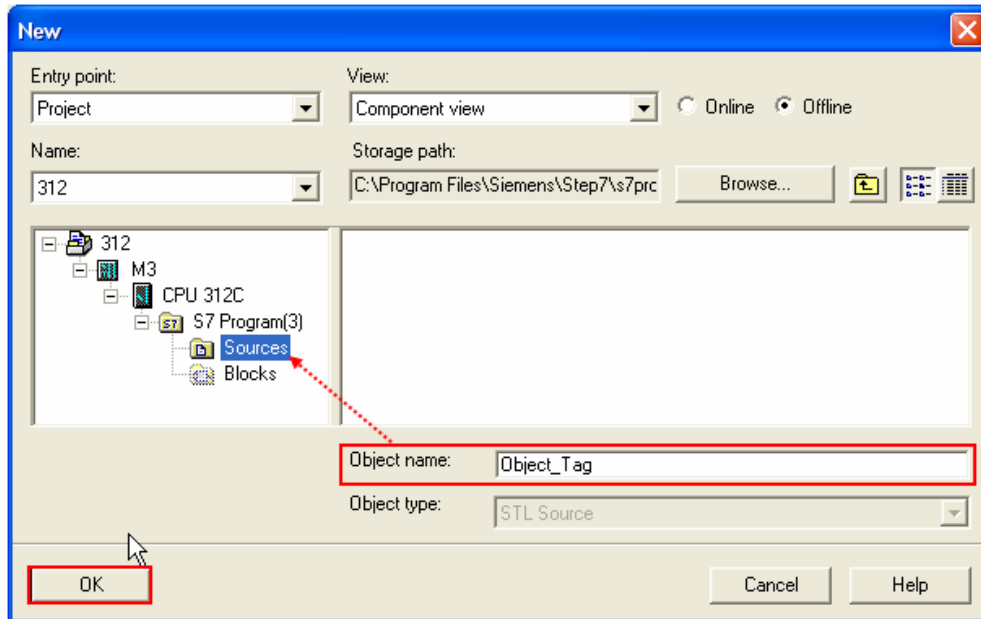

- d 、 Select the objects to be exported then click **OK**.

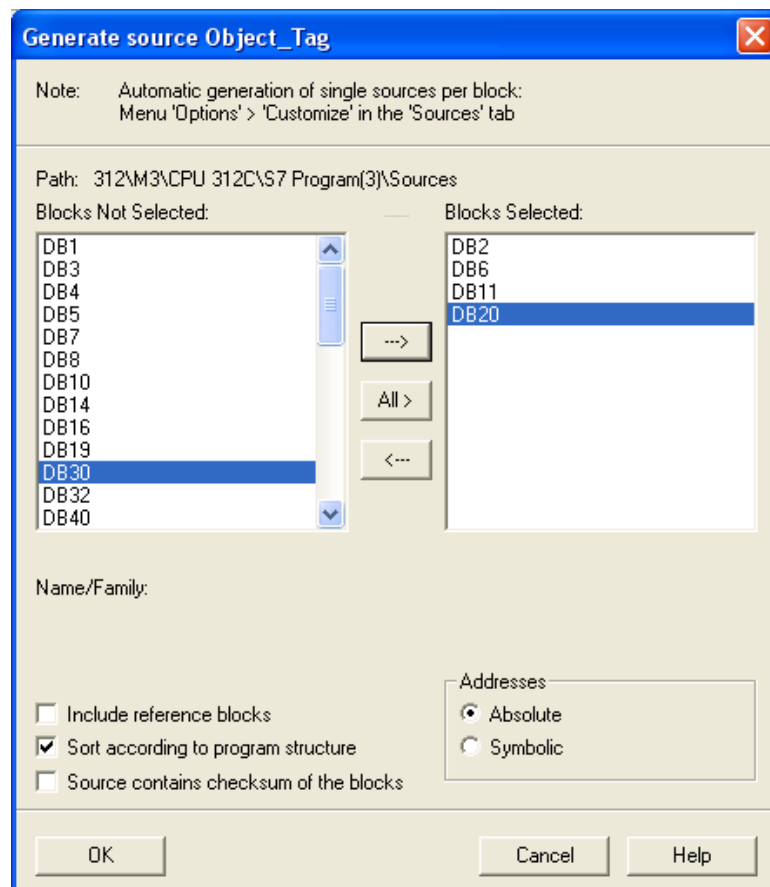

- e、 Under **Sources** there will be names of the saved files, select **Export Source** to build *.AWL file.

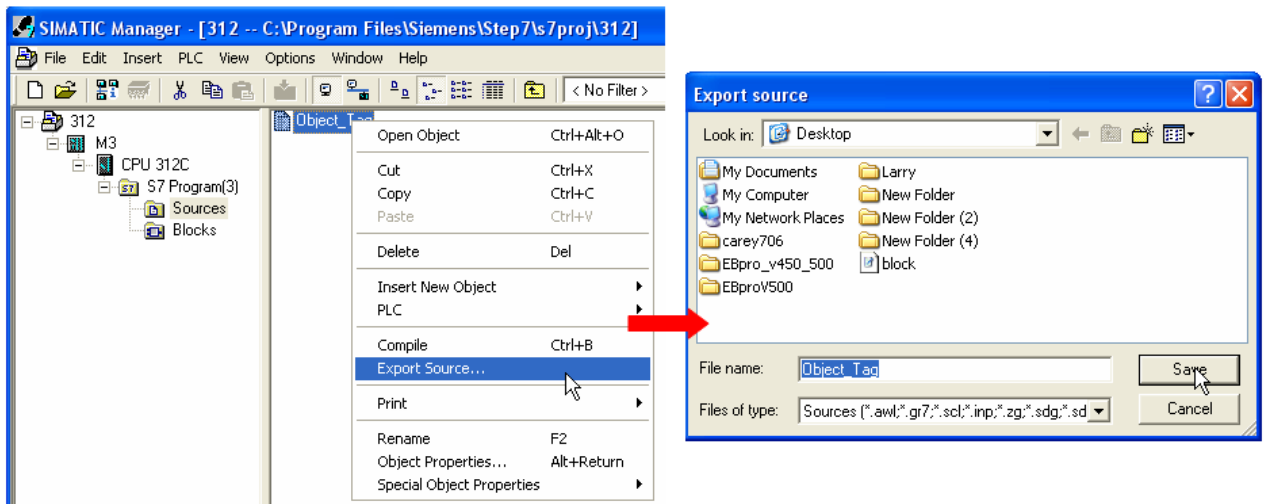

The generated *.dif and *.AWL files can be imported in EasyBuilder8000/EasyBuilderPro **System Parameter Settings**, by clicking **Import Tag**.

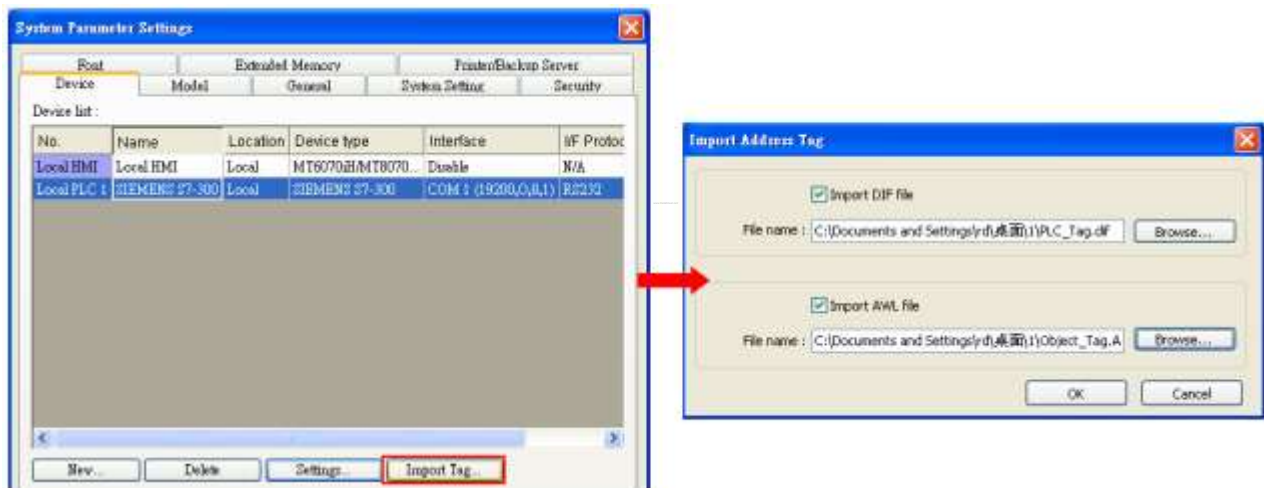

Tag information successfully imported.





Wiring Diagram:





The following represents the view of HMI & PLC.

Siemens S7-300 PC Adapter : 9P D-Sub to 9P D-Sub:



eMT3000 series

COM1 RS232 9P D-Sub Female	COM3 RS232 9P D-Sub Female		RS232 9P D-Sub Male
2 RX	8 RX		3 TXD
3 TX	7 TX		2 RXD
5 GND	5 GND		5 GND
			7 RTS
			8 CTS
			circuit
			

MT6000/8000 series except MT6050i/MT8050i

COM1 RS232 9P D-Sub Female	COM2 RS232 9P D-Sub Female	COM3 RS232 9P D-Sub Male	RS232 9P D-Sub Male
2 RX	6 RX	8 RX	3 TXD
3 TX	4 TX	7 TX	2 RXD
5 GND	5 GND	5 GND	5 GND
			7 RTS
			8 CTS
			circuit
			



MT6050i/MT8050i

COM1 RS232 9P D-Sub Female			RS232 9P D-Sub Male
9 RX			3 TXD
6 TX			2 RXD
5 GND			5 GND
			7 RTS
			8 CTS
			circuit
			





The following represents the view of HMI & PLC.

Systeme Helmholz SSW7-TS : 9P D-Sub to 9P D-Sub



eMT3000 series

COM1 RS232 9P D-Sub Female	COM3 RS232 9P D-Sub Female		RS232 9P D-Sub Male
2 RX	8 RX		3 TXD
3 TX	7 TX		2 RXD
5 GND	5 GND		5 GND
			7 RTS
			8 CTS
			4 DTR
			6 DSR
			circuit
			circuit
			

MT6000/8000 series except MT6050i/MT8050i

COM1 RS232 9P D-Sub Female	COM2 RS232 9P D-Sub Female	COM3 RS232 9P D-Sub Male	RS232 9P D-Sub Male
2 RX	6 RX	8 RX	3 TXD
3 TX	4 TX	7 TX	2 RXD
5 GND	5 GND	5 GND	5 GND
			7 RTS
			8 CTS
			4 DTR
			6 DSR
			circuit
			circuit
			

MT6050i/MT8050i

COM1 RS232 9P D-Sub Female			RS232 9P D-Sub Male
9 RX			3 TXD
6 TX			2 RXD
5 GND			5 GND
			7 RTS
			8 CTS
			4 DTR
			6 DSR
			circuit
			circuit
			

Driver Version:

Version	Date	Description
V3.10	May/24/2011	Added registers: MB & DBBn.

Siemens S7-300 MPI

Supported Series: Siemens S7-300 series PLC

Website: <http://www.siemens.com/entry/cc/en/>

HMI Setting:

Parameters	Recommended	Options	Notes
PLC type	SIEMENS S7-300 MPI		
PLC I/F	RS-485 2W		
Baud rate	187.5K		Only HMI with a sticker "MPI 187.5K" on the rear cover supports MPI communication.
Data bits	8		
Parity	Even		
Stop bits	1		
PLC sta. no.	2	2 ~ 31	

Online simulator	NO	Extend address mode	Yes (X Series does not support)
Broadcast command	NO	—	

Device Address:

Bit/Word	Device type	Format	Range	Memo
B	I	DDDDo	0 ~ 40957	Input (I)
B	Q	DDDDo	0 ~ 40957	Output (O)
B	M	DDDDo	0 ~ 40957	Bit Memory
B	DBnBit	FFFFDDDDo	0 ~ 409699997	Data Register Bit
B	DB0Bit ~	DDDDDo	0 ~ 655327	Data Register Bit
W	IW	DDDD	0 ~ 4095	Input (I)
W	QW	DDDD	0 ~ 4095	Output (O)
W	MW	DDDD	0 ~ 4095	Bit Memory
DW	MD	DDDD	0 ~ 4094	
Byte	MB	DDDD	0 ~ 4095	Bit Memory Byte
Byte	DBBn	FFFFDDDD	0 ~ 40969999	Data Register
W	DBn	FFFFDDDD	0 ~ 40969999	Data Register (must be even)

Bit/Word	Device type	Format	Range	Memo
DW	DBDn	FFFFDDDD	0 ~ 40969999	Data Register Double Word (multiple of 4)
W	DBn_String	FFFFDDDD	0 ~ 40969999	
DW	DBDn_String	FFFFDDDD	0 ~ 40969999	
W	DB0 ~ DB99	DDDD	0 ~ 65532	Data Register (must be even)

- Double word and floating point value must use DBDn device type.

Multi-HMIs-Multi-PLCs Communication Setting:



For SIEMENS S7-300 MPI driver in Multi-HMIs-Multi-PLCs communication, [Max. station no. (MPI network)] parameter must be correctly set. This setting is relevant to the station no. of the devices, as shown, two HMI (station no. 0, 1) and two PLC (station no. 2, 3) are in MPI network, Max. Station No. should be set to 3.

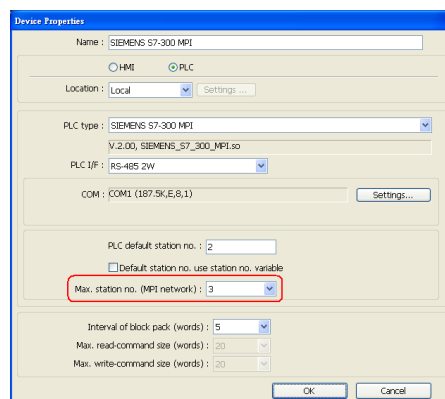

For the effectiveness of communication, users may set PLC device in STEP 7 as shown below. In Properties MPI / Network Settings, set Highest MPI address to the number closest to the actual device station number.

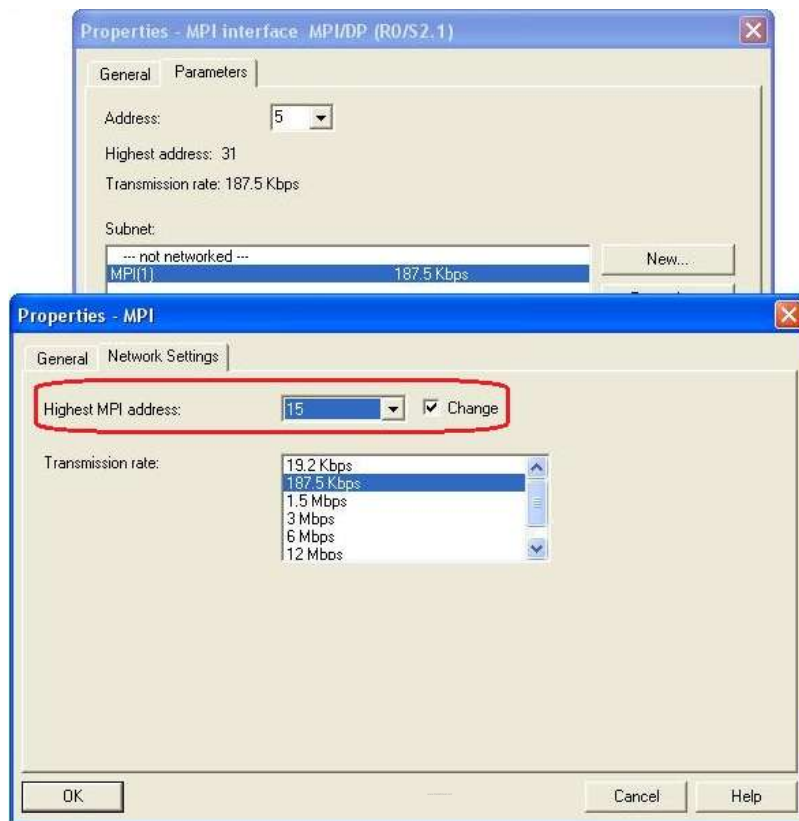

- HMI sta. no. can not be the same as PLC sta. no.
- Highly recommended that the device station numbers start from 0 sequentially and correctly set [Max. station no. (MPI network)].
- Available for EasyBuilder V4.50 and later.
- X Series does not support multiple-HMI-to-multiple-PLC communication, and supports only 1-HMI-to-1-PLC communication.

How to Import Tag:

SIEMENS STEP 7 program allows building files of user-defined tag (*.dif file and *.AWL file), and import these files in EasyBuilder8000/EasyBuilderPro -> System Parameter Settings. The following describes how to build and import these two types of files.

1. Building *.dif File

a. In “Symbols” create user-defined tag.

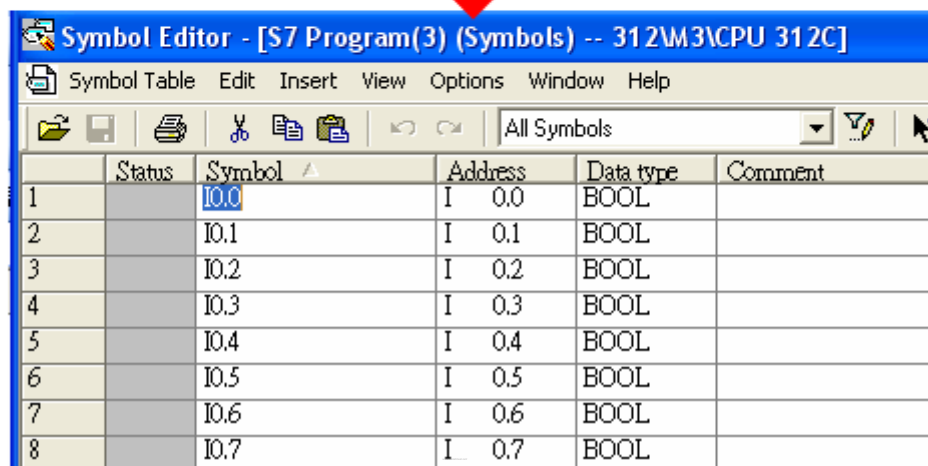
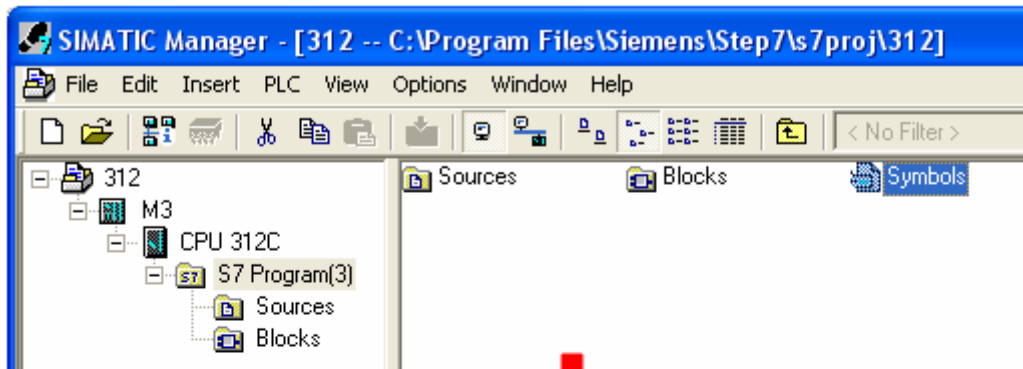

b. Click **Export** to export the edited file and click **Save**.

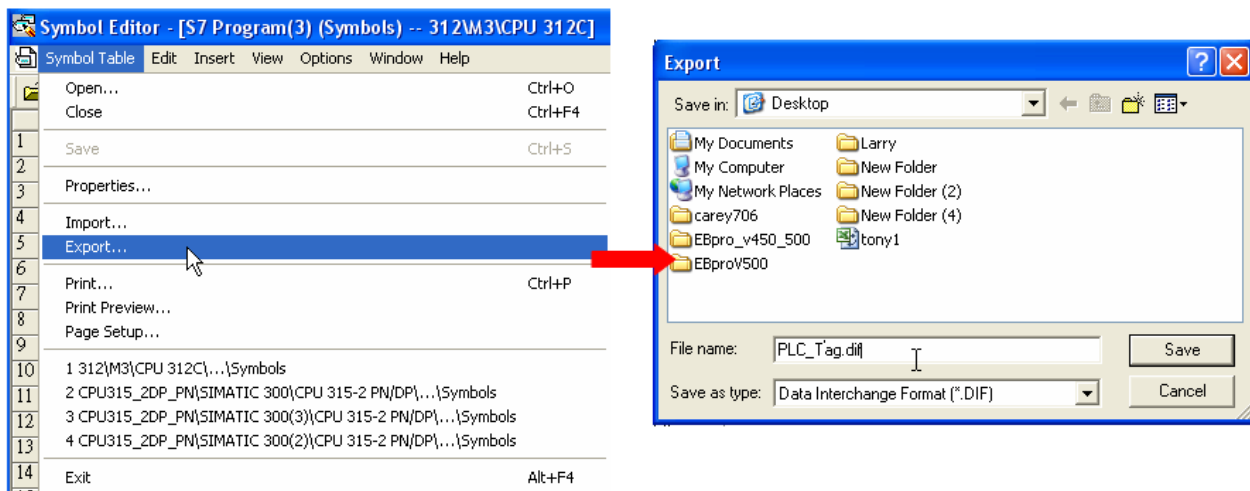

2. Building *.AWF File

a. In **Blocks** create items as shown below:

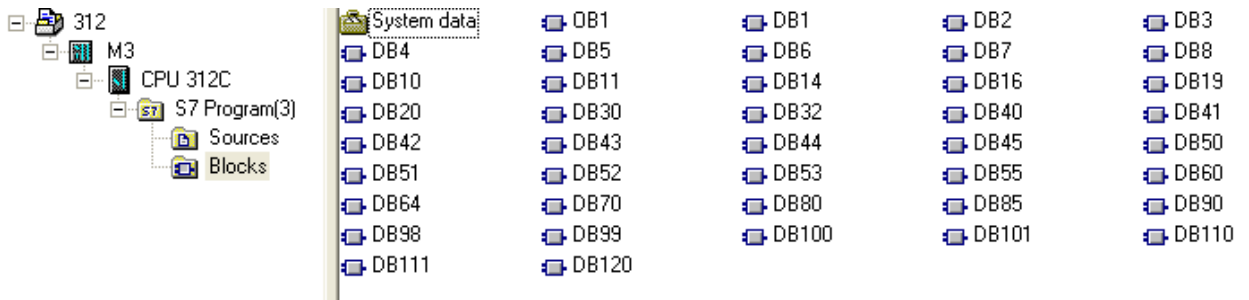

b. Open **LAD/STL, FBD – Programming S7 Blocks**, click **File -> Generate Source**.

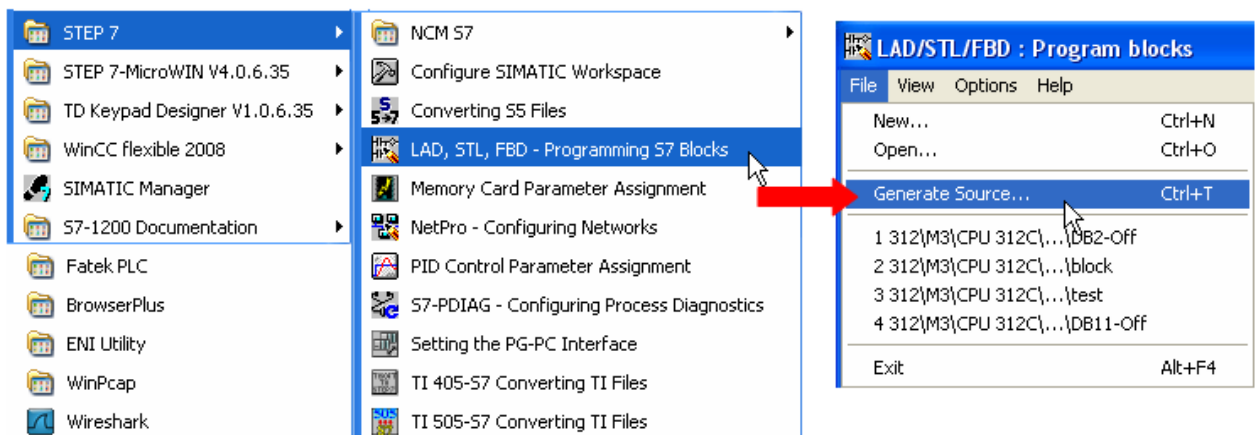

c. Select **Sources** as storage path, specify the file name then click **OK**.

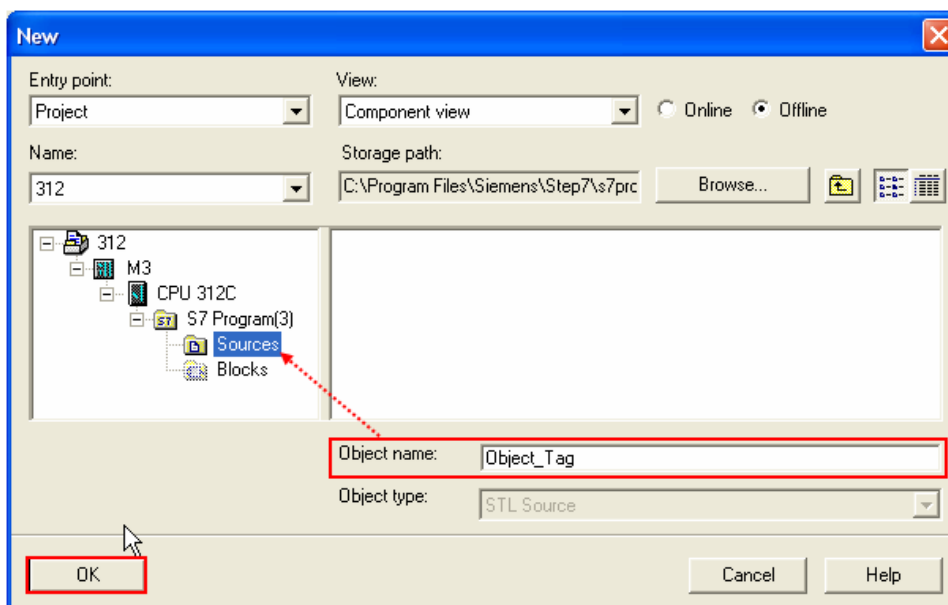

- d. Select the objects to be exported then click **OK**.

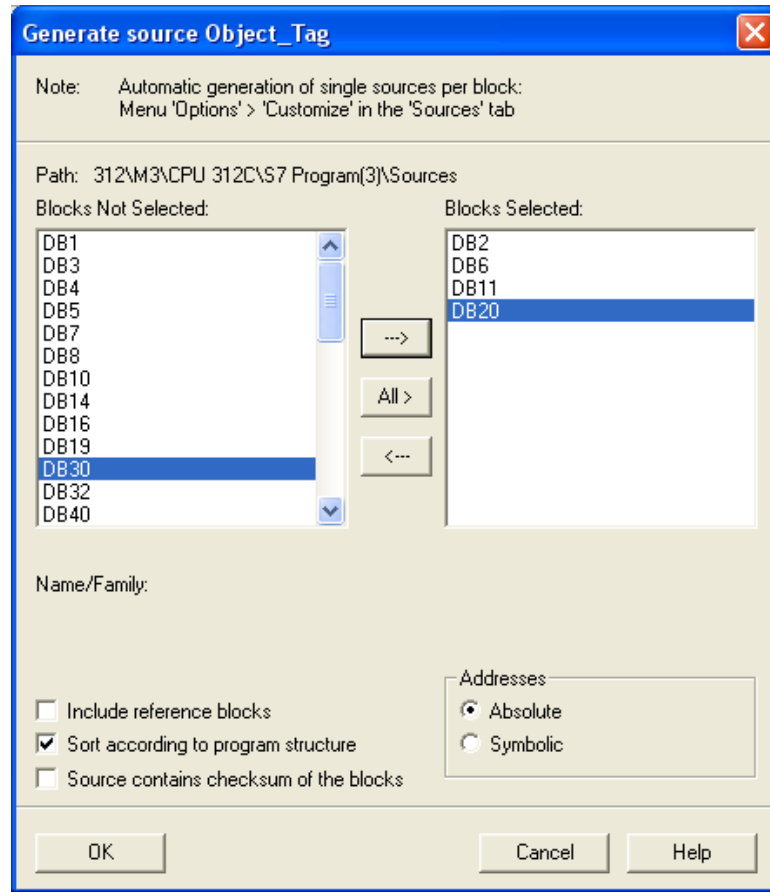

- e. Under **Sources** there will be names of the saved files, select **Export Source** to build *.AWL file.

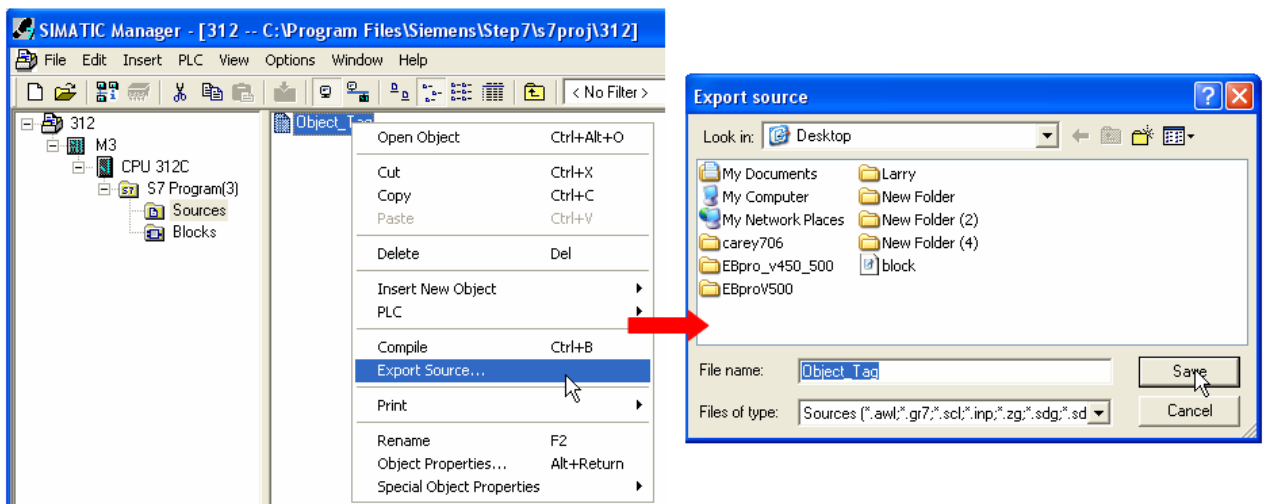

The generated *.dif and *.AWL files can be imported in EasyBuilder8000/EasyBuilderPro **System Parameter Settings**, by clicking **Import Tag**.

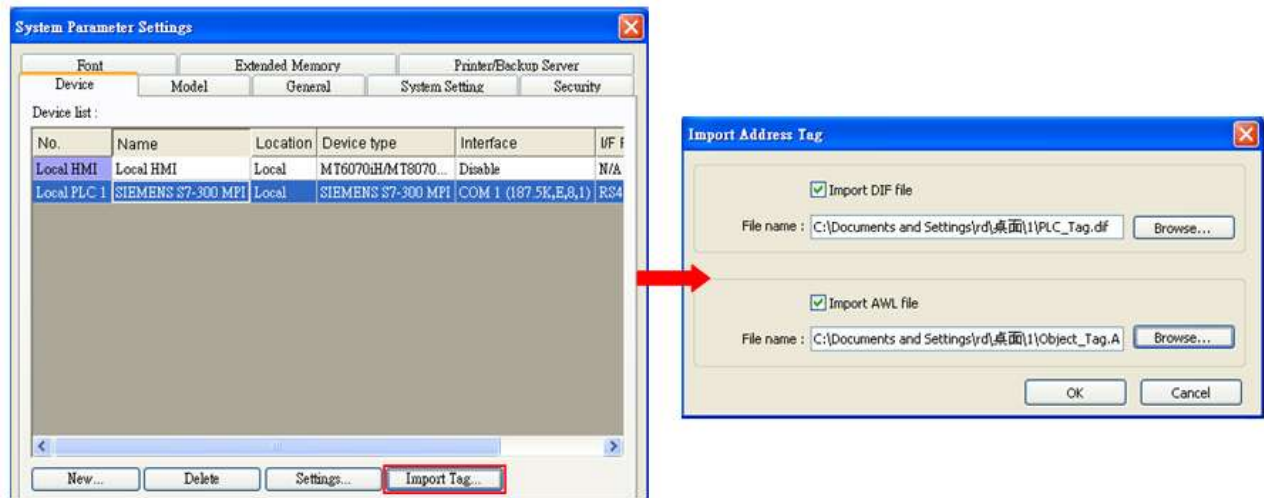

Tag information successfully imported.





Wiring Diagram:

The following represents the view of HMI & PLC.

S7-200 PPI , S7-300 MPI :RS485 2W



eMT3000 series

COM1 RS485 2W 9P D-Sub Male	COM3 RS485 2W 9P D-Sub Male		RS485 2W 9P D-Sub Male
1 RX-	6 Data-		8 D-
2 RX+	9 Data+		3 D+
5 GND	5 GND		5 GND
			

MT6000/8000 series except MT6050i/MT8050i

COM1 RS485 2W 9P D-Sub Male	COM3 RS485 2W 9P D-Sub Male		RS485 2W 9P D-Sub Male
1 RX-	6 Data-		8 D-
2 RX+	9 Data+		3 D+
5 GND	5 GND		5 GND
			

MT6050i/MT8050i

COM1 RS485 2W 9P D-Sub Female	COM3 RS485 2W 9P D-Sub Female		RS485 2W 9P D-Sub Male
1 RX-	7 Data-		8 D-
2 RX+	8 Data+		3 D+
5 GND	5 GND		5 GND
			

Driver Version:

Version	Date	Description
V1.90	May/26/2011	Added registers: MB & DBBn
V2.00	Aug/19d/2011	i Series HMI support Multi HMIs-Multi PLCs communication.

Siemens S7-300/ET200S (Ethernet)

Supported Series: Siemens S7-300 Ethernet Series PLC, Ethernet module CP-343-1, CPU315-2 PN/DP, CPU317-2 PN/DP, CPU319-3 PN/DP, and ET200S.

Website: <http://www.siemens.com/entry/cc/en/>

HMI Setting:

Parameters	Recommended	Options	Notes
PLC type	SIEMENS S7-300/ET200S (Ethernet)		
PLC I/F	Ethernet		
Port no.	102		
PLC sta. no.	1	0-31	

Device Address:

Bit/Word	Device type	Format	Range	Memo
B	I	DDDDo	0 ~ 40957	Input (I)
B	Q	DDDDo	0 ~ 40957	Output (O)
B	M	DDDDo	0 ~ 40957	Bit Memory
B	DBnBit	FFFFDDDDo	0 ~ 409699997	
B	DB0Bit-DB99Bit	DDDDDo	0 ~ 655327	Data Register Bit
W	IW	DDDD	0 ~ 4095	Input (I)
W	QW	DDDD	0 ~ 4095	Output (O)
W	MW	DDDD	0 ~ 4095	Bit Memory
DW	MD	DDDD	0 ~ 4094	Bit Memory Double Word
DW	MD_Anyaddr	DDDD	0 ~ 4094	Bit Memory Double Word (must be even)
W	DBn	FFFFDDDD	0 ~ 40969999	Data Register (must be even)
DW	DBDn	FFFFDDDD	0 ~ 40969999	Data Register Double Word (must be multiple of 4)
DW	DBDn_Anyaddr	FFFFDDDD	0 ~ 40969999	Data Register Double Word (must be even)
W	DBn_String	FFFFDDDD	0 ~ 40969999	
DW	DBDn_String	FFFFDDDD	0 ~ 40969999	
W	DB0 ~ DB99	DDDD	0 ~ 65532	Data Register

Bit/Word	Device type	Format	Range	Memo
				(must be even)
Byte	MB	DDDD	0 ~ 4095	Bit Memory Byte
Byte	DBBn	FFFFDDDD	0 ~ 40969999	Data Register Byte

- Double word and floating point value must use DBDn device type.

How to Import Tag:

SIEMENS STEP 7 program allows building files of user-defined tag (*.dif file and *.AWL file), and import these files in EasyBuilder8000/EasyBuilderPro -> System Parameter Settings. The following describes how to build and import these two types of files.

1. Building *.dif File

- a. In "Symbols" create user-defined tag.

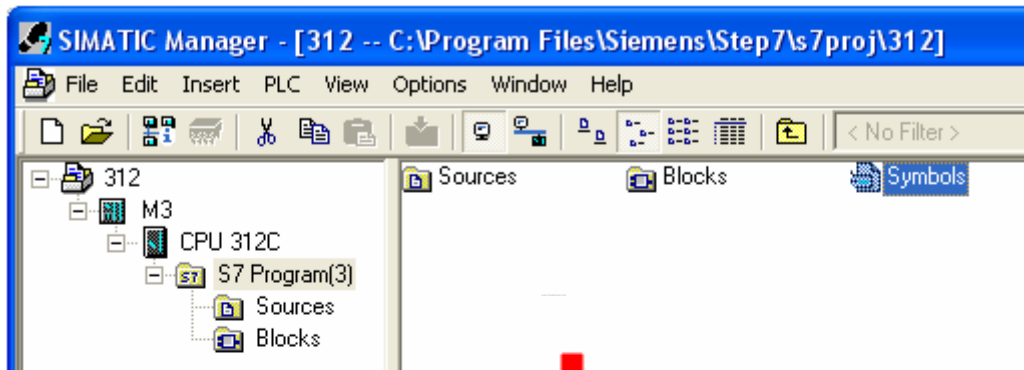
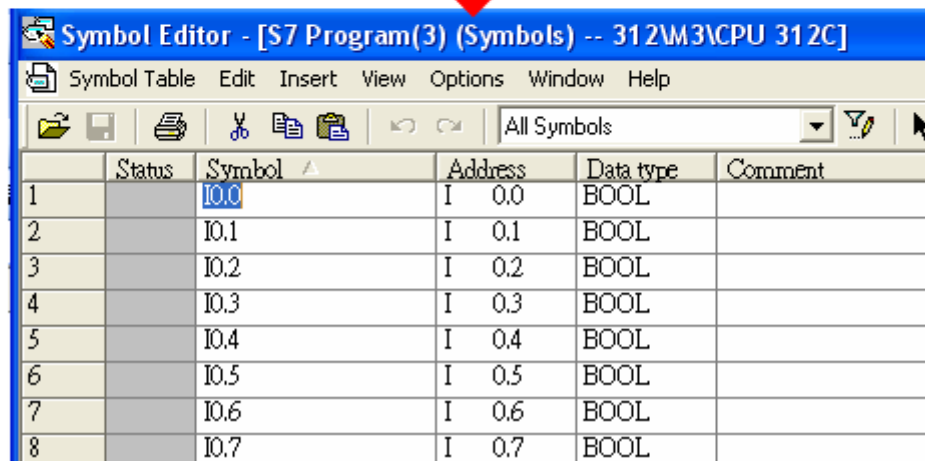
The screenshot shows the Symbol Editor window titled 'Symbol Editor - [S7 Program(3) (Symbols) -- 312M3\CPU 312C]'. The menu bar includes Symbol Table, Edit, Insert, View, Options, Window, and Help. The toolbar contains icons for file operations and editing. A dropdown menu shows 'All Symbols'. The main area is a table with the following columns: Status, Symbol, Address, Data type, and Comment.

	Status	Symbol	Address	Data type	Comment
1		I0.0	I 0.0	BOOL	
2		I0.1	I 0.1	BOOL	
3		I0.2	I 0.2	BOOL	
4		I0.3	I 0.3	BOOL	
5		I0.4	I 0.4	BOOL	
6		I0.5	I 0.5	BOOL	
7		I0.6	I 0.6	BOOL	
8		I0.7	I 0.7	BOOL	

b ․ Click **Export** to export the edited file and click **Save**.

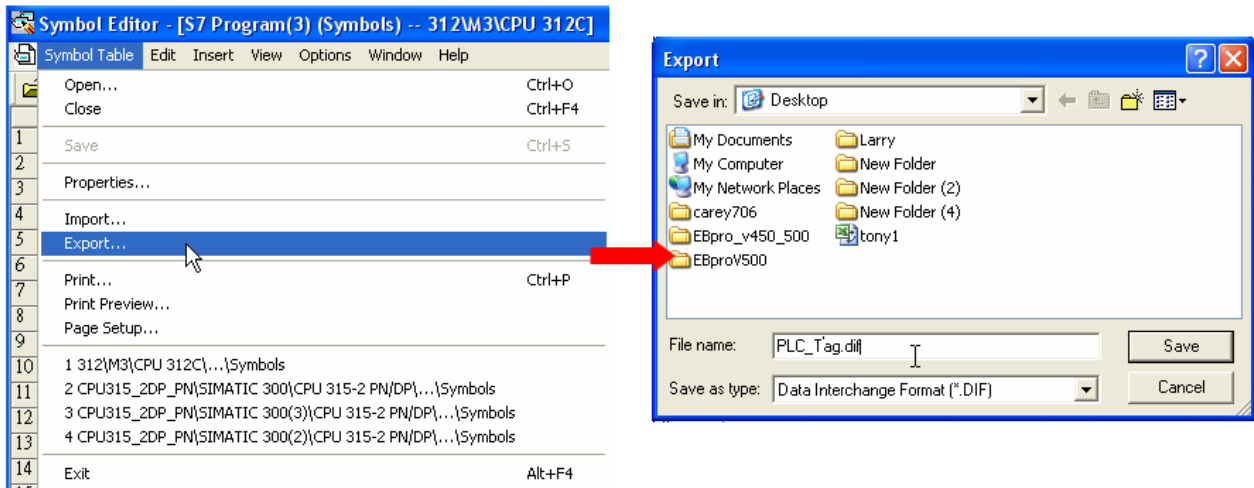

2. Building *.AWF File

a ․ In **Blocks** create items as shown below:

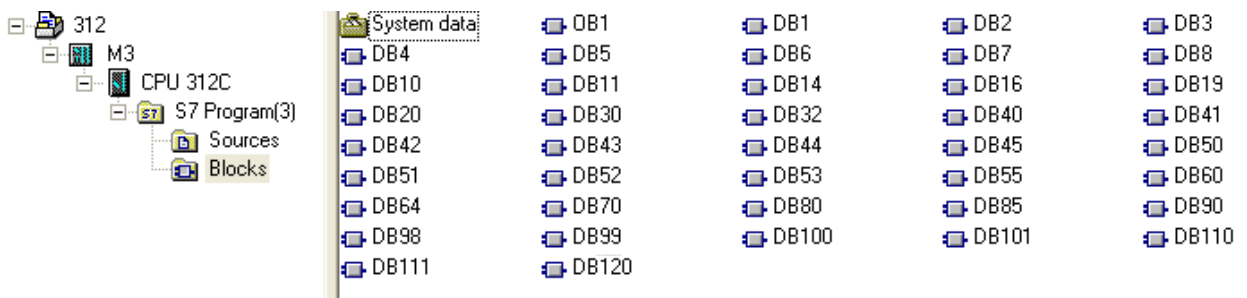

b ․ Open LAD/STL, FBD – Programming S7 Blocks, click **File -> Generate Source**.

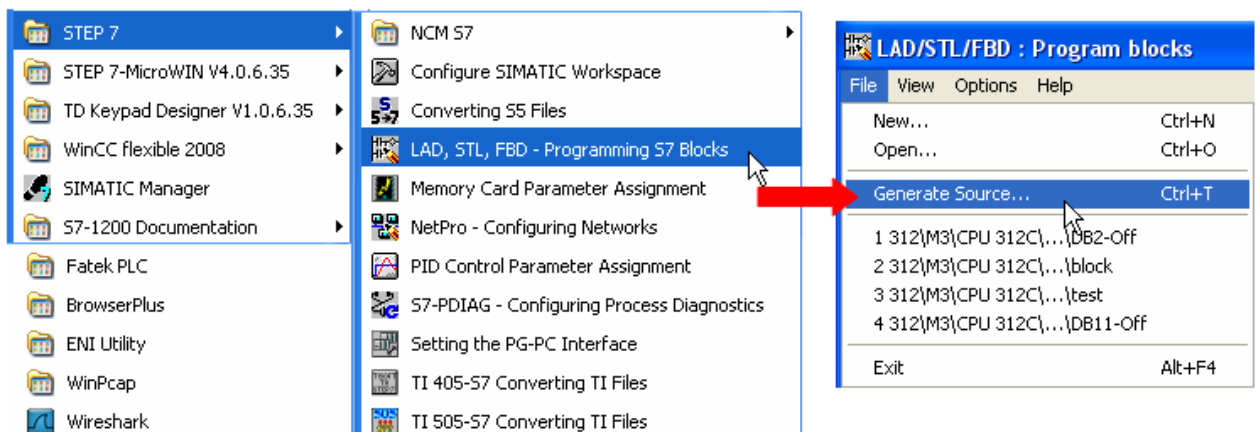

- c ․ Select **Sources** as storage path, specify the file name then click **OK**.

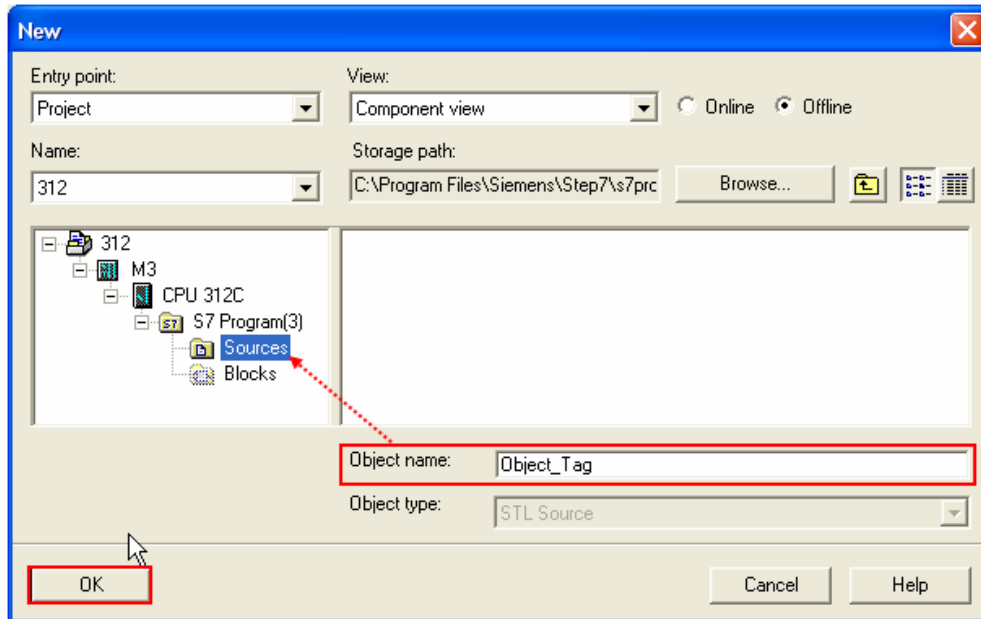

- d ․ Select the objects to be exported then click **OK**.

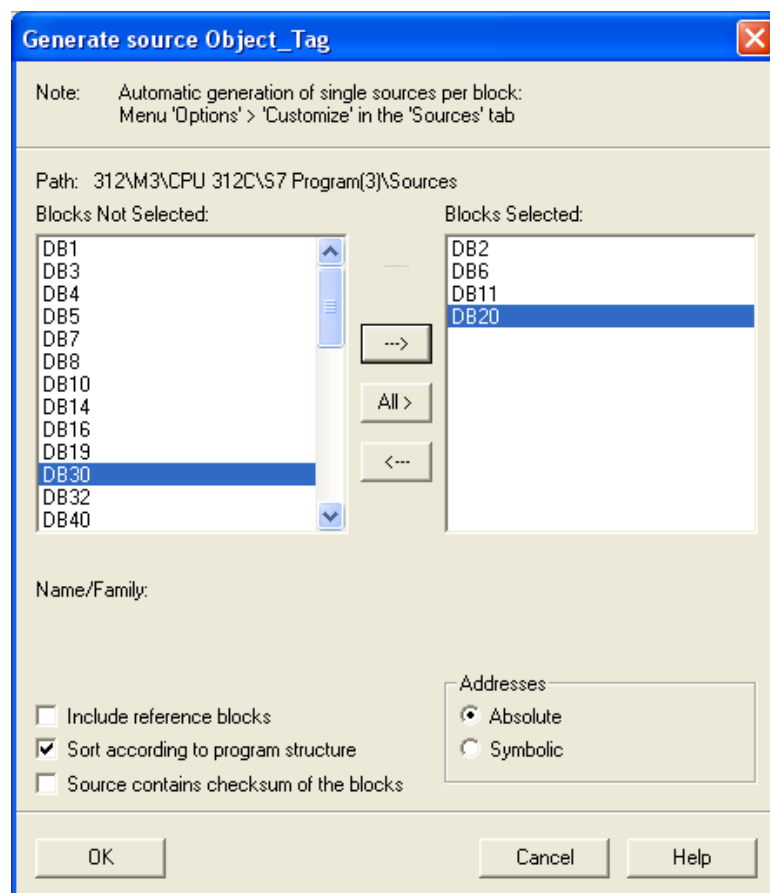

- e、 Under **Sources** there will be names of the saved files, select **Export Source** to build ***.AWL** file.

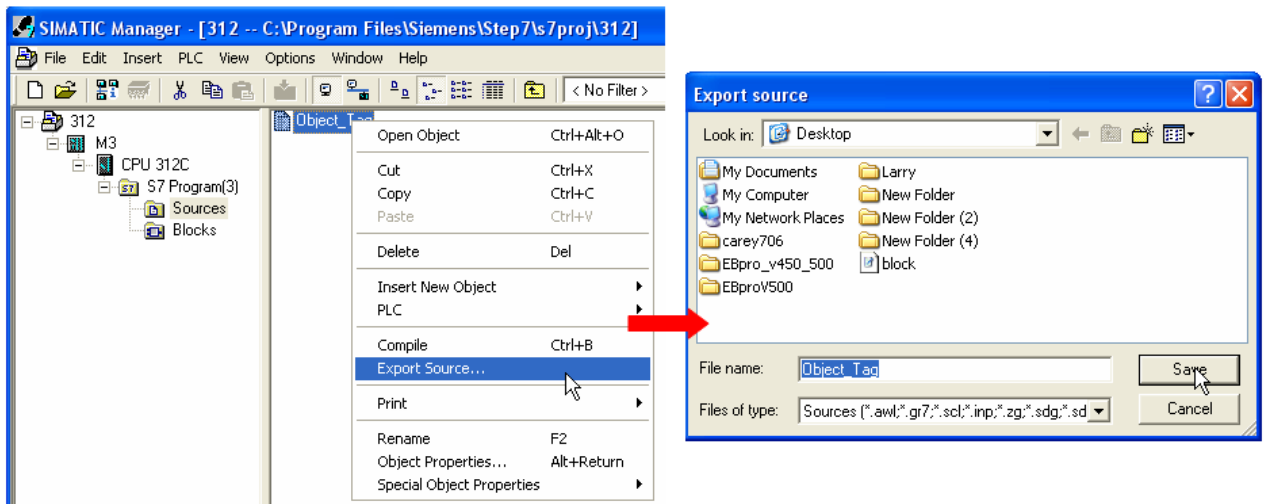

The generated ***.dif** and ***.AWL** files can be imported in EasyBuilder8000/EasyBuilderPro **System Parameter Settings**, by clicking **Import Tag**.

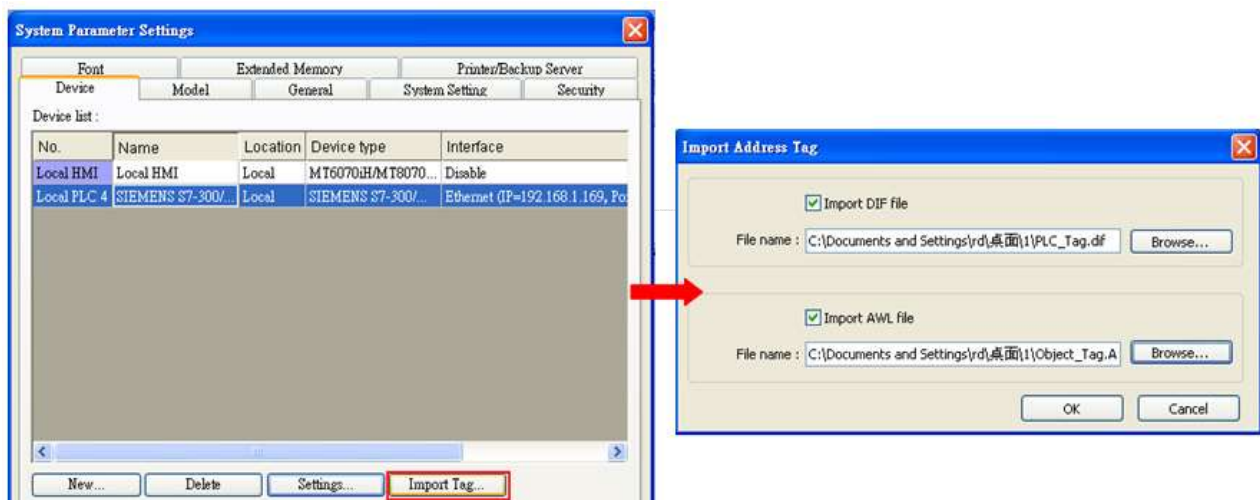

Tag information successfully imported.



Wiring Diagram:

Direct connect (crossover cable):

HMI RJ45 Male	Wire Color	PLC RJ45 Male
1 TX+	White/Orange	3 RX+
2 TX-	Orange	6 RX-
3 RX+	White/Green	1 TX+
4 BD4+	Blue	4 BD4+
5 BD4-	White/Blue	5 BD4-
6 RX-	Green	2 TX-
7 BD3+	White/Brown	7 BD3+
8 BD3-	Brown	8 BD3-



Through a hub:

HMI RJ45 Male	Wire Color	PLC RJ45 Male
1 TX+	White/Orange	1 TX+
2 TX-	Orange	2 TX-
3 RX+	White/Green	3 RX+
4 BD4+	Blue	4 BD4+
5 BD4-	White/Blue	5 BD4-
6 RX-	Green	6 RX-
7 BD3+	White/Brown	7 BD3+
8 BD3-	Brown	8 BD3-



Driver Version:

Version	Date	Description
V2.10	May/21/2011	Added registers: MB & DBBn.
V2.20	Apr/25/2012	Added registers: MD_Anyaddr & DBDn_Anyaddr.

Siemens S7-400 (Ethernet)

Supported Series: Siemens S7-400/1200 Ethernet PLC.

Website: <http://www.siemens.com/entry/cc/en/>

HMI Setting:

Parameters	Recommended	Options	Notes
PLC type	Siemens S7-400 (Ethernet)		
PLC I/F	Ethernet		
Port no.	102		
Link type	PG	PC, OP	
Rack	0	0-7	
CPU slot	3	1-31	To Connect with S7-1200,slot 1 must be selected.
PLC sta. no.	0	0-31	

Device Address:

Bit/Word	Device type	Format	Range	Memo
B	I	DDDDo	0 ~ 40957	Input (I)
B	Q	DDDDo	0 ~ 40957	Output (O)
B	M	DDDDo	0 ~ 40957	Bit Memory
B	DBnBit	FFFFFFDDDDo	0 ~ 655359997	
B	DB0Bit-DB99Bit	DDDDDo	0 ~ 655327	Data Register Bit
W	IW	DDDD	0 ~ 4095	Input (I)
W	QW	DDDD	0 ~ 4095	Output (O)
W	MW	DDDD	0 ~ 4095	Bit Memory
DW	MD	DDDD	0 ~ 4094	
W	DBn	FFFFFFDDDD	0 ~ 655359999	Data Register (must be even)
DW	DBDn	FFFFFFDDDD	0 ~ 655359999	Data Register Double Word (must be multiple of 4)
W	DBn_String	FFFFFFDDDD	0 ~ 655359999	
DW	DBDn_String	FFFFFFDDDD	0 ~ 655359999	
W	DB0 ~ DB99	DDDD	0 ~ 65532	Data Register (must be even)
Byte	MB	DDDD	0 ~ 4095	Bit Memory Byte
Byte	DBBn	FFFFFFDDDD	0 ~ 655359999	Data Register Byte

* Double word and floating point value must use DBDn device type.

Wiring Diagram:

Direct connect (crossover cable):

HMI RJ45 Male	Wire Color	PLC RJ45 Male
1 TX+	White/Orange	3 RX+
2 TX-	Orange	6 RX-
3 RX+	White/Green	1 TX+
4 BD4+	Blue	4 BD4+
5 BD4-	White/Blue	5 BD4-
6 RX-	Green	2 TX-
7 BD3+	White/Brown	7 BD3+
8 BD3-	Brown	8 BD3-



Through a hub:

HMI RJ45 Male	Wire Color	PLC RJ45 Male
1 TX+	White/Orange	1 TX+
2 TX-	Orange	2 TX-
3 RX+	White/Green	3 RX+
4 BD4+	Blue	4 BD4+
5 BD4-	White/Blue	5 BD4-
6 RX-	Green	6 RX-
7 BD3+	White/Brown	7 BD3+
8 BD3-	Brown	8 BD3-



EasyBuilder Device Setting Steps

1. Open EasyBuilder, File/NEW, select HMI model and press [OK].

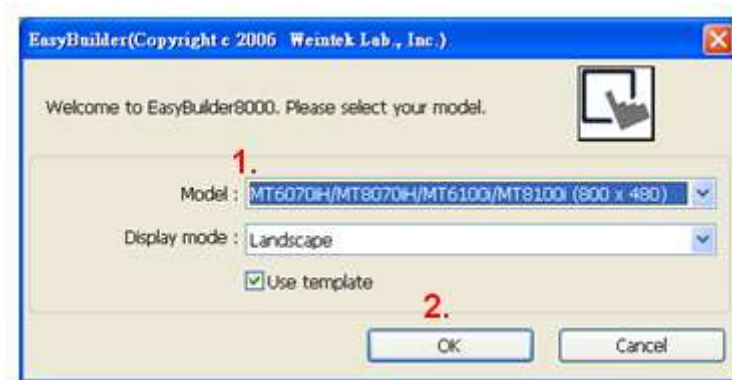

2. "System Parameter Settings" window is shown, click [New].
3. Select "SIEMENS S7-400(ETHERNET)".

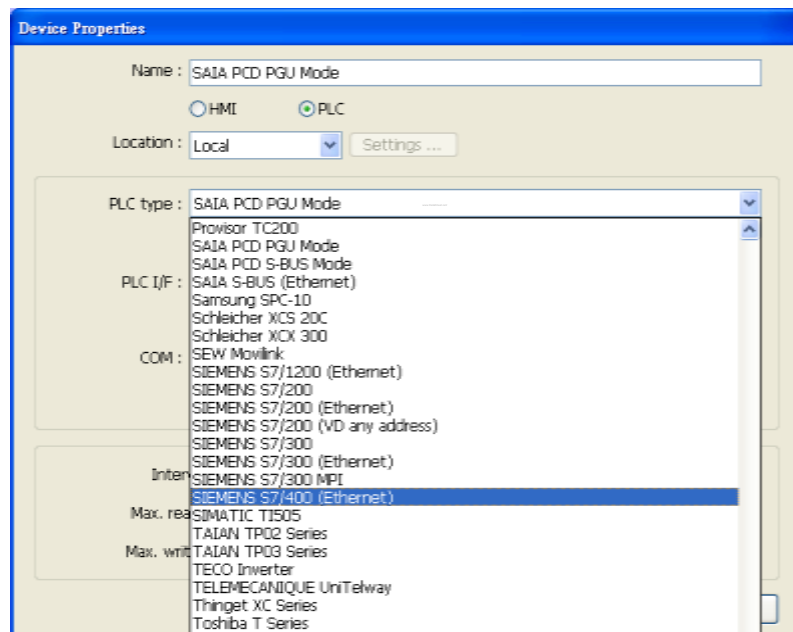

4. Press [Settings].

5. Set S7-400 IP, Port no., Link type, Rack and CPU slot. (must match PLC settings)

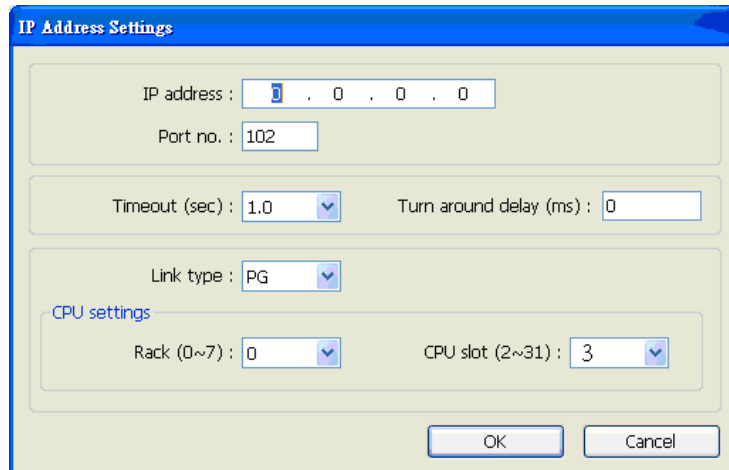

The 'IP Address Settings' dialog box contains the following fields and options:

- IP address: 192.168.1.1
- Port no.: 102
- Timeout (sec): 1.0
- Turn around delay (ms): 0
- Link type: PG
- CPU settings:
 - Rack (0~7): 0
 - CPU slot (2~31): 3

Buttons: OK, Cancel

6. The setting will be finished as below.

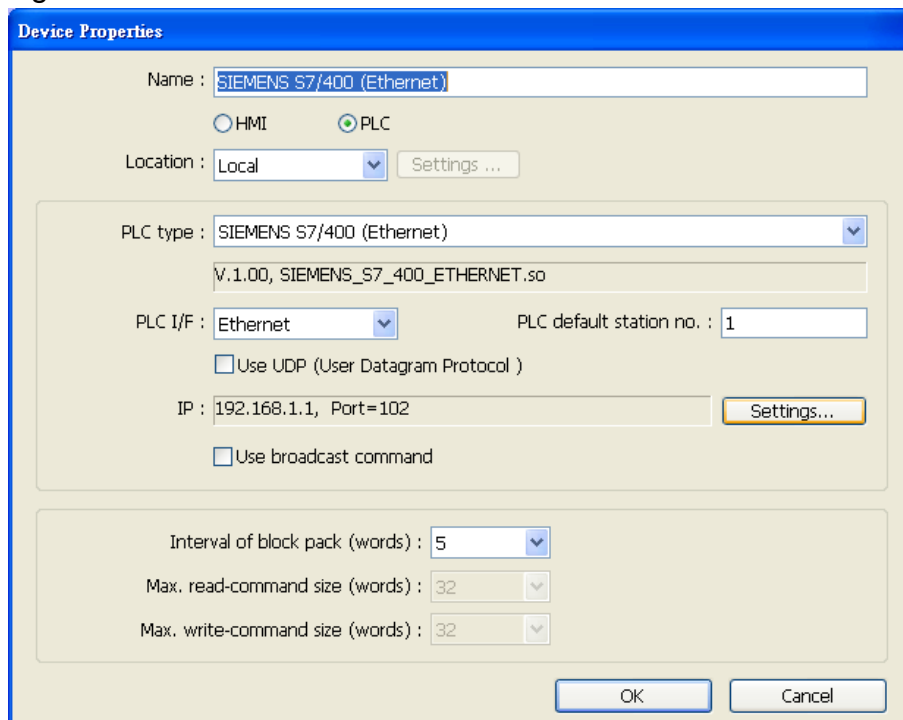

The 'Device Properties' dialog box contains the following fields and options:

- Name: SIEMENS S7/400 (Ethernet)
- Device type: HMI, PLC
- Location: Local
- PLC type: SIEMENS S7/400 (Ethernet)
- Version: V.1.00, SIEMENS_S7_400_ETHERNET.so
- PLC I/F: Ethernet
- PLC default station no.: 1
- Use UDP (User Datagram Protocol)
- IP: 192.168.1.1, Port=102
- Use broadcast command
- Interval of block pack (words): 5
- Max. read-command size (words): 32
- Max. write-command size (words): 32

Buttons: OK, Cancel

How to Import Tag:

SIEMENS STEP 7 program allows building files of user-defined tag (*.dif file and *.AWL file), and import these files in EasyBuilder8000/EasyBuilderPro -> System Parameter Settings. The following describes how to build and import these two types of files.

1. Building *.dif File

- a. In “Symbols” create user-defined tag.

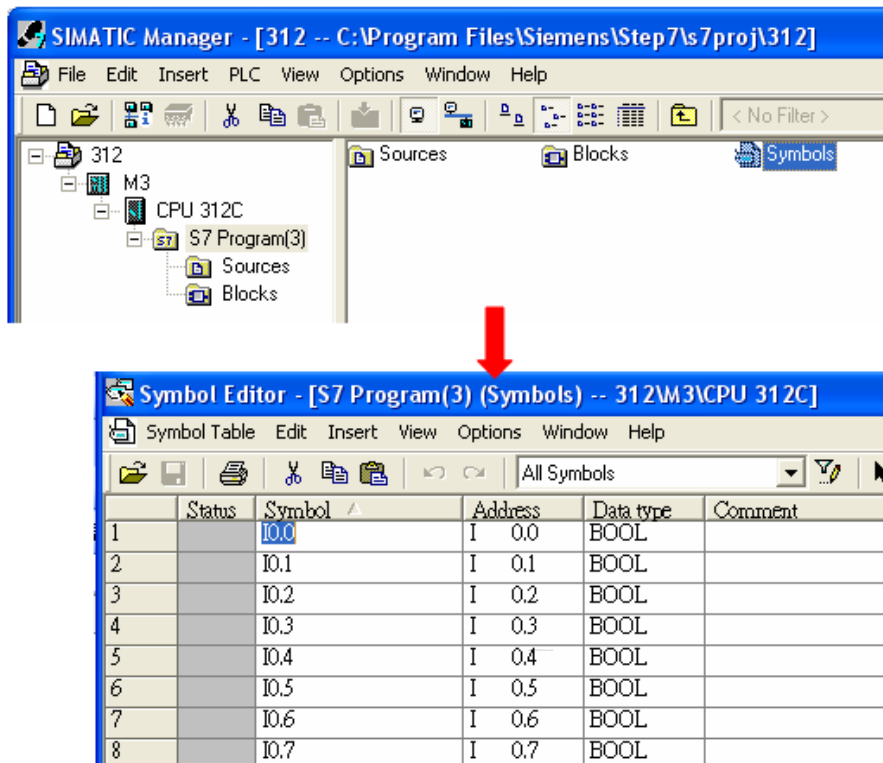

- b. Click **Export** to export the edited file and click **Save**.

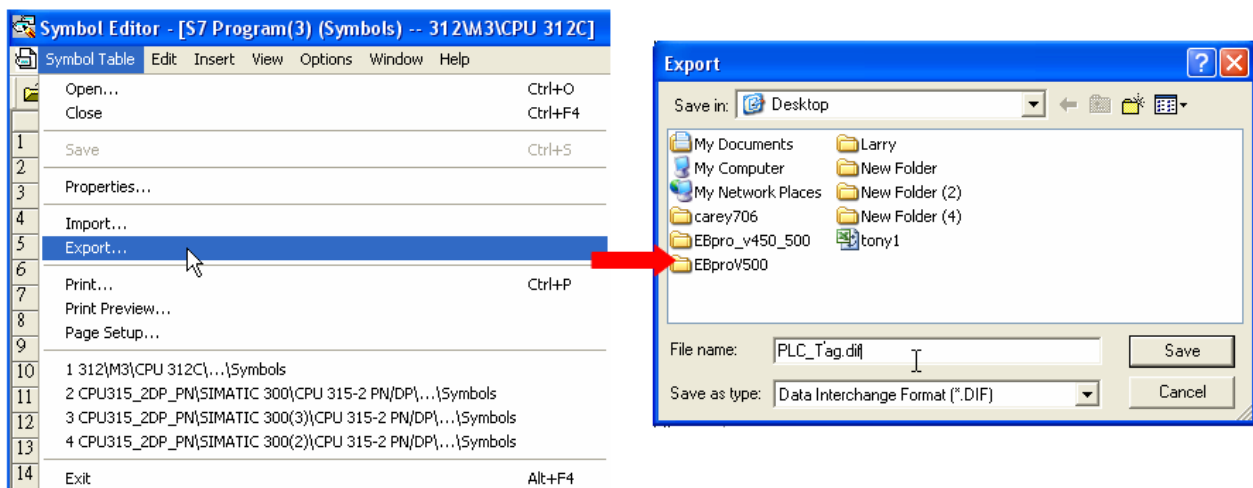

2. Building *.AWF File

a. In **Blocks** create items as shown below:

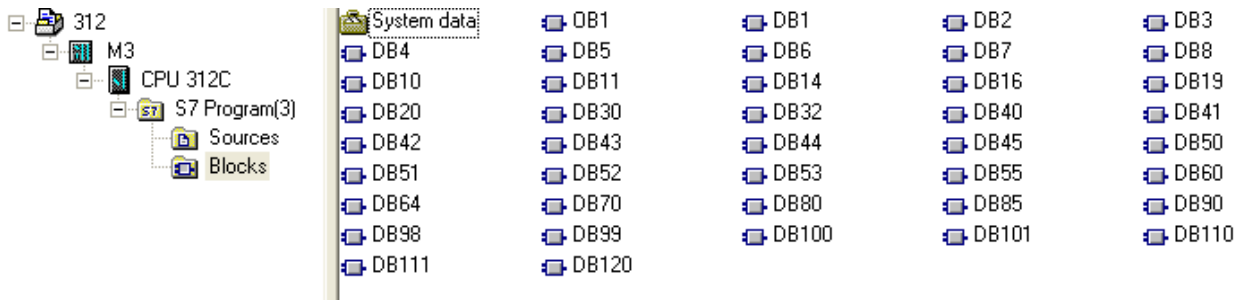

b. Open **LAD/STL, FBD – Programming S7 Blocks**, click **File -> Generate Source**.

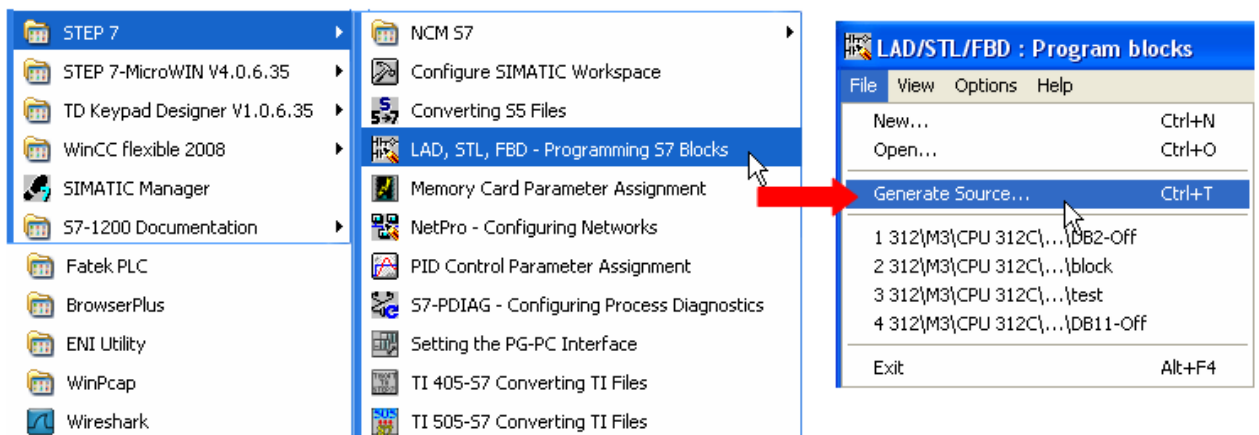

c. Select **Sources** as storage path, specify the file name then click **OK**.

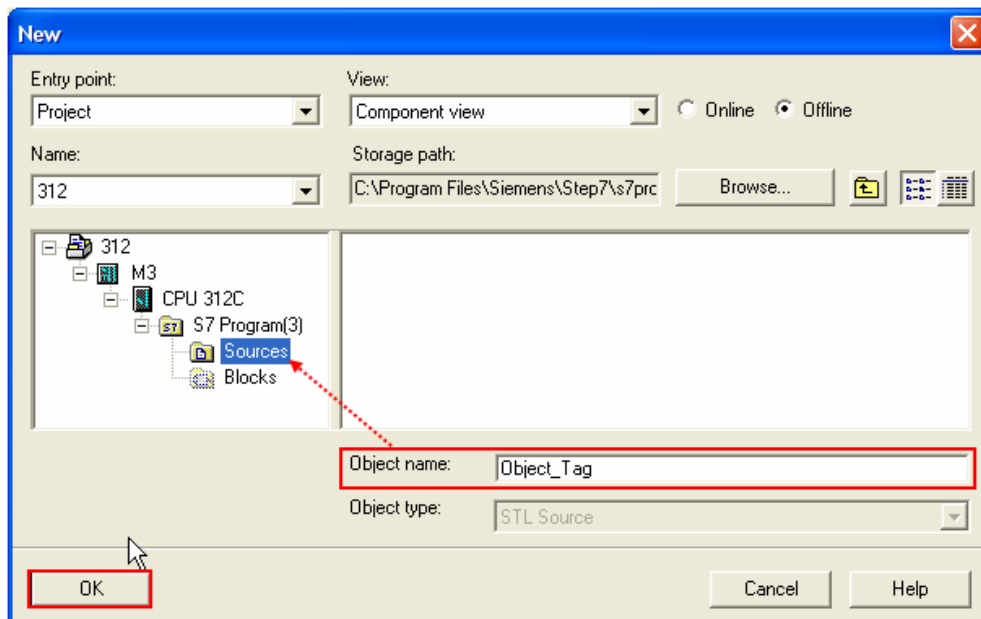

- d 、 Select the objects to be exported then click **OK**.

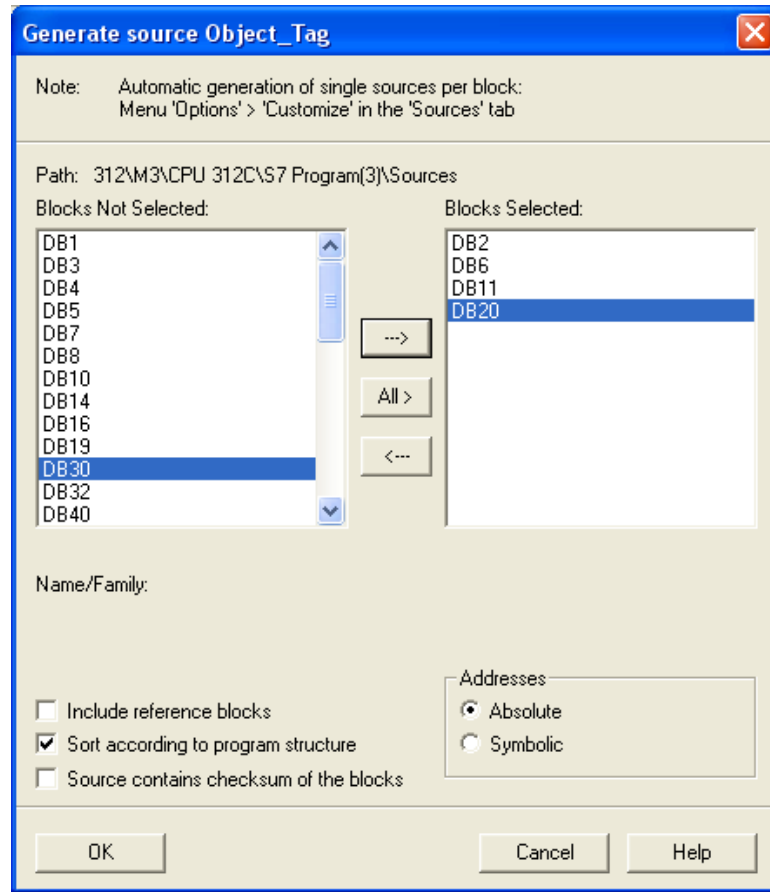

- e 、 Under **Sources** there will be names of the saved files, select **Export Source** to build *.AWL file.

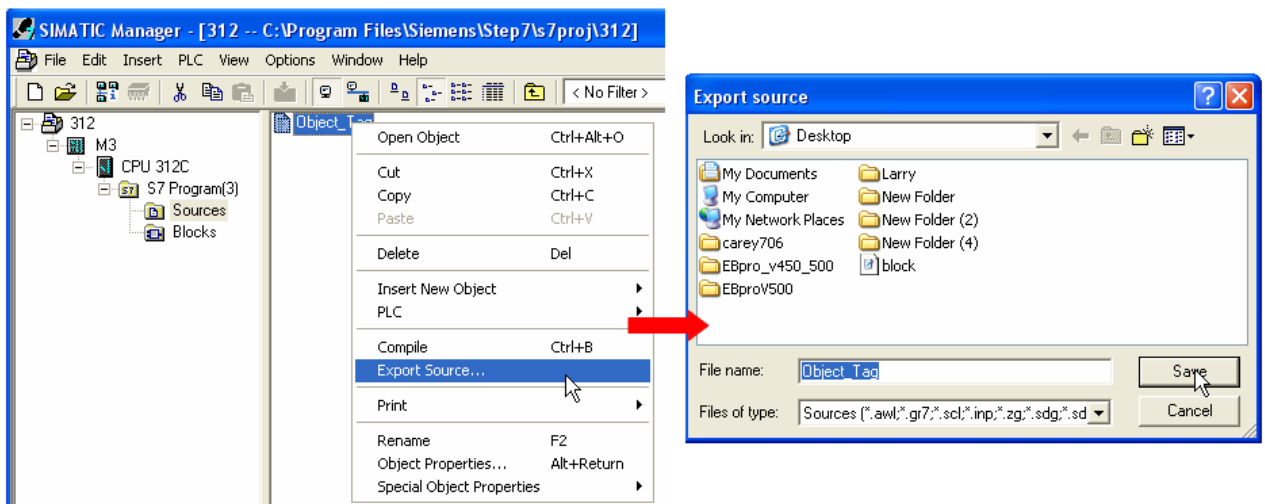

The generated *.dif and *.AWL files can be imported in EasyBuilder8000/EasyBuilderPro **System Parameter Settings**, by clicking **Import Tag**.

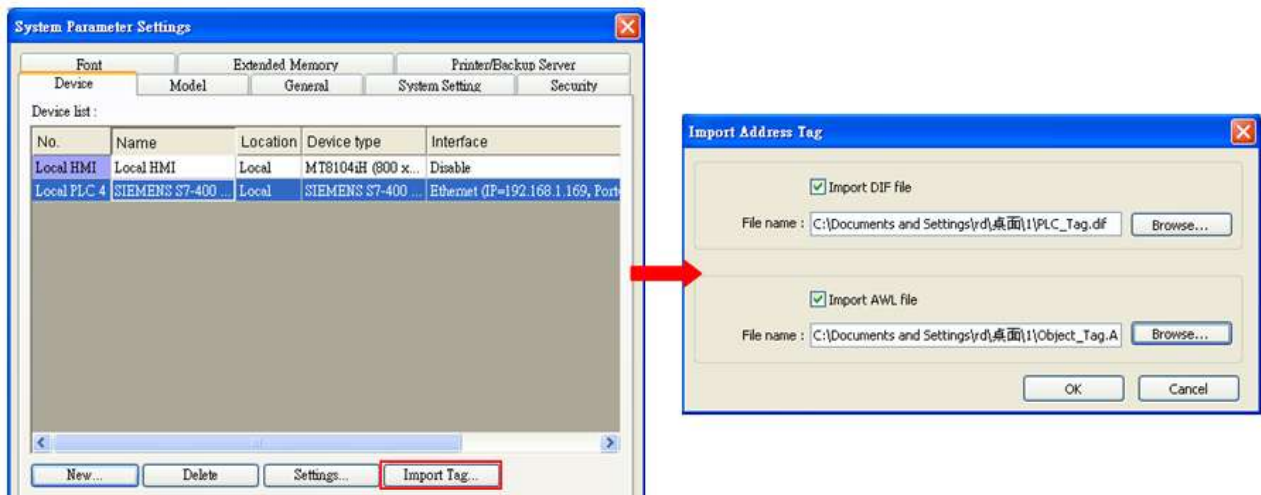

Tag information successfully imported.



Driver Version:

Version	Date	Description
V1.40	May/25/2011	Added registers: MB & DBBn
V1.50	Aug/03/2012	Device types DBn, DBDn is extended to 655359999.

Siemens TI505

Supported Series: SIMATIC TI505 Series PLCs: TI520, TI525, TI530, TI535, TI545, TI555, TI560, TI565, TI575. Use NITP protocol in a point-to-point, single master, single slave format.

Website: <http://www.siemens.com/entry/cc/en/>

HMI Setting:

Parameters	Recommended	Options	Notes
PLC type	SIMATIC TI505		NITP protocol
PLC I/F	RS232	RS232,	
Baud rate	19200	19200	
Data bits	7	7	
Parity	Odd	Odd	
Stop bits	1	1	
PLC sta. no.	0	Does not apply	

Device Address:



Bit/Word	Device type	Format	Range	Memo
B	CR	DDDDD	1 ~ 65535	Internal Relay
B	X	DDDDD	1 ~ 65535	Discrete Input Coils
B	Y	DDDDD	1 ~ 65535	Discrete Output Coils
W	V	DDDDD	1 ~ 65535	User Data Registers
W	STW	DDDDD	1 ~ 65535	Status Word Registers
W	TCP	DDDDD	1 ~ 65535	Timer/Counter Preset Values
W	TCC	DDDDD	1 ~ 65535	Timer/Counter Current Values
W	WX	DDDDD	1 ~ 65535	Word Discrete Inputs
W	WY	DDDDD	1 ~ 65535	Word Discrete Outputs

Wiring Diagram:



The following represents the view of HMI & PLC.

SIMATIC TI505 RS232 : 9P D-Sub to 25P D-Sub



eMT3000 series

COM1 RS232 9P D-Sub Female	COM3 RS232 9P D-Sub Female		RS232 25P D-Sub Male
2 RX	8 RX		2 TXD
3 TX	7 TX		3 RXD
5 GND	5 GND		7 GND
			4 RTS
			5 CTS
			6 DSR
			8 DCD
			20 DTR
			circuit
			circuit
			

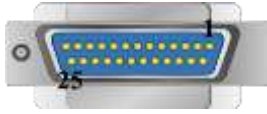
MT6000/8000 series except MT6050i/MT8050i

COM1 RS232 9P D-Sub Female	COM2 RS232 9P D-Sub Female	COM3 RS232 9P D-Sub Male	RS232 25P D-Sub Male
2 RX	6 RX	8 RX	2 TXD
3 TX	4 TX	7 TX	3 RXD
5 GND	5 GND	5 GND	7 GND
			4 RTS
			5 CTS
			6 DSR
			8 DCD
			20 DTR
			circuit
			circuit
			



MT6050i/MT8050i

COM1 RS232 9P D-Sub Female			RS232 25P D-Sub Male
9 RX			2 TXD
6 TX			3 RXD
5 GND			7 GND
			4 RTS
			5 CTS
			6 DSR
			8 DCD
			20 DTR
			circuit
			circuit
			





The following represents the view of HMI & PLC.

SIMATIC TI505 RS232 : 9P D-Sub to 9P D-Sub



eMT3000 series

COM1 RS232 9P D-Sub Female	COM3 RS232 9P D-Sub Female		RS232 9P D-Sub Male
2 RX	8 RX		3 TXD
3 TX	7 TX		2 RXD
5 GND	5 GND		5 GND
			7 RTS
			8 CTS
			1 DCD
			4 DTR
			6 DSR
			circuit
			circuit
			

MT6000/8000 series except MT6050i/MT8050i

COM1 RS232 9P D-Sub Female	COM2 RS232 9P D-Sub Female	COM3 RS232 9P D-Sub Male	RS232 9P D-Sub Male	
2 RX	6 RX	8 RX	3 TXD	
3 TX	4 TX	7 TX	2 RXD	
5 GND	5 GND	5 GND	5 GND	
			7 RTS	7 RTS
			8 CTS	8 CTS
			1 DCD	1 DCD
			4 DTR	4 DTR
			6 DSR	
				



MT6050i/MT8050i

COM1 RS232 9P D-Sub Female			RS232 9P D-Sub Male	
9 RX			3 TXD	
6 TX			2 RXD	
5 GND			5 GND	
			7 RTS	circuit
			8 CTS	
			1 DCD	circuit
			4 DTR	
			6 DSR	
				



The following represents the view of HMI & PLC.

SIMATIC TI505 RS485 4W : 9P D-Sub to 9P D-Sub



eMT3000 series

COM1 RS485 4W 9P D-Sub Male			RS485 4W 9P D-Sub Male
1 RX-			7 DO (-)
2 RX+			1 DO (+)
3 TX-			8 DI (-)
4 TX+			5 DI (+)
5 GND			6 GND
			

MT6000/8000 series except MT6050i/MT8050i

COM1 RS485 4W 9P D-Sub Male			RS485 4W 9P D-Sub Male
1 RX-			7 DO (-)
2 RX+			1 DO (+)
3 TX-			8 DI (-)
4 TX+			5 DI (+)
5 GND			6 GND
			

MT6050i/MT8050i

COM1 RS485 4W 9P D-Sub Female			RS485 4W 9P D-Sub Male
1 RX-			7 DO (-)
2 RX+			1 DO (+)
3 TX-			8 DI (-)
4 TX+			5 DI (+)
5 GND			6 GND
			

Driver Version:

Version	Date	Description
V1.10	Apr/22/2009	

Siemens TI565/C400

Website: <http://www.siemens.com/entry/cc/en/>

HMI Setting:

Parameters	Recommended	Options	Notes
PLC type	SIMATIC TI565/C400		
PLC I/F	RS232	RS232, RS485(4W)	
Baud rate	19200	19200	
Data bits	7	7	
Parity	Odd	Odd	
Stop bits	1	1	
PLC sta. no.	0	Does not apply	

Device Address:



Bit/Word	Device type	Format	Range	Memo
B	CR	DDDDD	1 ~ 65535	Internal Relay
B	X	DDDDD	1 ~ 65535	Discrete Input Coils
B	Y	DDDDD	1 ~ 65535	Discrete Output Coils
B	V_Bit	DDDDDdd	100 ~ 6553515	User Data Registers
W	V	DDDDD	1 ~ 65535	User Data Registers
W	STW	DDDDD	1 ~ 65535	Status Word Registers
W	TCP	DDDDD	1 ~ 65535	Timer/Counter Preset Values
W	TCC	DDDDD	1 ~ 65535	Timer/Counter Current Values
W	WX	DDDDD	1 ~ 65535	Word Discrete Inputs
W	WY	DDDDD	1 ~ 65535	Word Discrete Outputs

Wiring Diagram:



The following represents the view of HMI & PLC.

9P D-Sub to 25P D-Sub: RS232



eMT3000 series

COM1 RS232 9P D-Sub Female	COM3 RS232 9P D-Sub Female		RS232 25P D-Sub Male
2 RX	8 RX		2 TXD
3 TX	7 TX		3 RXD
5 GND	5 GND		7 GND
			4 RTS
			5 CTS
			6 DSR
			8 DCD
			20 DTR
			circuit
			circuit
			

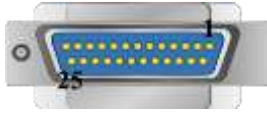
MT6000/8000 series except MT6050i/MT8050i

COM1 RS232 9P D-Sub Female	COM2 RS232 9P D-Sub Female	COM3 RS232 9P D-Sub Male	RS232 25P D-Sub Male
2 RX	6 RX	8 RX	2 TXD
3 TX	4 TX	7 TX	3 RXD
5 GND	5 GND	5 GND	7 GND
			4 RTS
			5 CTS
			6 DSR
			8 DCD
			20 DTR
			circuit
			circuit
			



MT6050i/MT8050i

COM1 RS232 9P D-Sub Female			RS232 25P D-Sub Male	
9 RX			2 TXD	
6 TX			3 RXD	
5 GND			7 GND	
			4 RTS	
			5 CTS	circuit
			6 DSR	circuit
			8 DCD	
			20 DTR	
				







The following represents the view of HMI & PLC.

9P D-Sub to 9P D-Sub: RS232



eMT3000 series

COM1 RS232 9P D-Sub Female	COM3 RS232 9P D-Sub Female		RS232 9P D-Sub Male	
2 RX	8 RX		3 TXD	
3 TX	7 TX		2 RXD	
5 GND	5 GND		5 GND	
			7 RTS	
			8 CTS	circuit
			1 DCD	circuit
			4 DTR	
			6 DSR	
				

MT6000/8000 series except MT6050i/MT8050i

COM1 RS232 9P D-Sub Female	COM2 RS232 9P D-Sub Female	COM3 RS232 9P D-Sub Male	RS232 9P D-Sub Male	
2 RX	6 RX	8 RX	3 TXD	
3 TX	4 TX	7 TX	2 RXD	
5 GND	5 GND	5 GND	5 GND	
  			7 RTS	circuit
			8 CTS	
			1 DCD	circuit
			4 DTR	
			6 DSR	
   				



MT6050i/MT8050i

COM1 RS232 9P D-Sub Female			RS232 9P D-Sub Male	
9 RX			3 TXD	
6 TX			2 RXD	
5 GND			5 GND	
			7 RTS	circuit
			8 CTS	
			1 DCD	circuit
			4 DTR	
			6 DSR	
 				



The following represents the view of HMI & PLC.

9P D-Sub to 9P D-Sub: RS-485 4W



eMT3000 series

COM1 RS485 4W 9P D-Sub Male			RS485 4W 9P D-Sub Male
1 RX-			7 DO (-)
2 RX+			1 DO (+)
3 TX-			8 DI (-)
4 TX+			5 DI (+)
5 GND			6 GND
			

MT6000/8000 series except MT6050i/MT8050i

COM1 RS485 4W 9P D-Sub Male			RS485 4W 9P D-Sub Male
1 RX-			7 DO (-)
2 RX+			1 DO (+)
3 TX-			8 DI (-)
4 TX+			5 DI (+)
5 GND			6 GND
			

MT6050i/MT8050i

COM1 RS485 4W 9P D-Sub Female			RS485 4W 9P D-Sub Male
1 RX-			7 DO (-)
2 RX+			1 DO (+)
3 TX-			8 DI (-)
4 TX+			5 DI (+)
5 GND			6 GND
			

Driver Version:

Version	Date	Description
V1.00	Aug/31/2011	Driver released.

SSTC SSD Series

Supported Series: SSTC SSD Series

HMI Setting:

Parameters	Recommended	Options	Notes
PLC type	SSTC SSD Series		
PLC I/F	RS232	RS232/RS485 2W	
Baud rate	19200	9600~115200	
Data bits	8	8	
Parity	None	None,Odd	
Stop bits	1	1	
PLC sta. no.	1	1~32	

X Series does not support RS-485 2W communication.

Device Address:

Bit/Word	Device Type	Format	Range	Memo
W	ID	DDDDD	0 ~ 99999	
W	ID_30	DDDDD	30	Use Unicode
W	ID_35000	DDDDD	35000	String
W	ID_35001	DDDDD	35001	String

ID Address List:

ID No.	Data Length	Data Type	Write / Read	Decimal Place*
1	BYT2	UDEC	Yes/Yes	1
30	BYT4	HEX	No/Yes	Hex
36	BYT4	SDEC	Yes/Yes	0.0001
38	BYT4	UDEC	Yes/Yes	0.0001
39	BYT4	SDEC	Yes/Yes	0.0001
40	BYT4	SDEC	No/Yes	0.0001
41	BYT4	SDEC	No/Yes	0.0001
43	BYT2	UDEC	Yes/Yes	1
47	BYT4	SDEC	Yes/Yes	1
48	BYT4	SDEC	Yes/Yes	1

ID No.	Data Length	Data Type	Write / Read	Decimal Place*
49	BYT4	SDEC	Yes/Yes	1
50	BYT4	SDEC	Yes/Yes	1
51	BYT4	SDEC	Yes/Yes	1
53	BYT4	SDEC	Yes/Yes	1
55	BYT2	UDEC	Yes/Yes	1
57	BYT4	UDEC	Yes/Yes	1
80	BYT2	SDEC	Yes/Yes	0.1
82	BYT2	UDEC	Yes/Yes	0.1
83	BYT2	SDEC	Yes/Yes	0.1
84	BYT2	SDEC	No/Yes	0.1
85	BYT2	UDEC	Yes/Yes	1
100	BYT2	UDEC	Yes/Yes	1
101	BYT2	UDEC	Yes/Yes	0.1
102	BYT2	UDEC	Yes/Yes	0.1
103	BYT4	SDEC	Yes/Yes	1
104	BYT2	UDEC	Yes/Yes	1
109	BYT4	UDEC	Yes/Yes	0.001
110	BYT4	UDEC	No/Yes	0.001
111	BYT4	UDEC	Yes/Yes	0.001
112	BYT4	UDEC	No/Yes	0.001
113	BYT4	UDEC	Yes/Yes	0.0001
116	BYT4	UDEC	Yes/Yes	1
124	BYT4	SDEC	Yes/Yes	0.0001
125	BYT4	SDEC	Yes/Yes	0.0001
126	BYT2	SDEC	Yes/Yes	0.1
136	BYT4	SDEC	Yes/Yes	1
137	BYT4	SDEC	Yes/Yes	1
147	BYT2	HEX	Yes/Yes	Hex
150	BYT4	SDEC	Yes/Yes	1
153	BYT4	SDEC	Yes/Yes	1
154	BUT2	HEX	Yes/Yes	Hex
157	BYT4	SDEC	Yes/Yes	0.0001
159	BYT4	UDEC	Yes/Yes	1
173	BYT4	SDEC	Yes/Yes	1

ID No.	Data Length	Data Type	Write / Read	Decimal Place*
193	BYT2	UDEC	Yes/Yes	1
209	BYT4	UDEC	Yes/Yes	0.0001
210	BYT4	UDEC	Yes/Yes	0.0001
211	BYT2	UDEC	Yes/Yes	0.1
212	BYT2	UDEC	Yes/Yes	0.1
222	BYT4	SDEC	Yes/Yes	1
225	BYT2	HEX	Yes/Yes	Hex
228	BYT4	UDEC	Yes/Yes	1
230	BYT4	UDEC	Yes/Yes	1
268	BYT4	UDEC	Yes/Yes	1
278	BYT4	UDEC	Yes/Yes	1
32768	BYT2	UDEC	Yes/Yes	0.1
32769	BYT4	UDEC	Yes/Yes	0.001
32770	BYT4	UDEC	Yes/Yes	0.001
32771	BYT2	UDEC	Yes/Yes	0.1
32772	BYT4	UDEC	Yes/Yes	0.0001
32773	BYT4	HEX	Yes/Yes	Hex
32774	BYT2	UDEC	Yes/Yes	0.1
32775	BYT2	UDEC	Yes/Yes	1
32776	BYT2	UDEC	Yes/Yes	1
32777	BYT2	SDEC	Yes/Yes	0.1
32778	BYT4	SDEC	Yes/Yes	0.0001
32779	BYT4	SDEC	Yes/Yes	0.0001
32780	BYT4	UDEC	Yes/Yes	0.1
32781	BYT4	UDEC	Yes/Yes	0.1
32782	BYT4	UDEC	Yes/Yes	0.1
32783	BYT2	UDEC	Yes/Yes	1
32784	BYT4	SDEC	Yes/Yes	1
32785	BYT2	UDEC	Yes/Yes	1
32786	BYT4	SDEC	Yes/Yes	1
32787	BYT4	UDEC	Yes/Yes	1
32788	BYT4	SDEC	Yes/Yes	1
32789	BYT4	UDEC	Yes/Yes	1
32790	BYT4	SDEC	Yes/Yes	1

ID No.	Data Length	Data Type	Write / Read	Decimal Place*
32791	BYT4	UDEC	Yes/Yes	1
32792	BYT4	SDEC	Yes/Yes	1
32793	BYT4	UDEC	Yes/Yes	1
32794	BYT4	SDEC	Yes/Yes	1
32797	BYT4	HEX	No/Yes	Hex
32798	BYT4	HEX	No/No	Hex
32799	BYT4	HEX	No/No	Hex
32800	BYT4	HEX	Yes/Yes	Hex
32801	BYT4	HEX	Yes/Yes	Hex
32802	BYT4	HEX	Yes/Yes	Hex
32803	BYT4	HEX	Yes/Yes	Hex
32804	BYT4	HEX	Yes/Yes	Hex
32805	BYT4	HEX	Yes/Yes	Hex
32806	BYT4	UDEC	Yes/Yes	1
32807	BYT4	UDEC	Yes/Yes	1
32808	BYT4	UDEC	Yes/Yes	1
32809	BYT4	UDEC	Yes/Yes	1
32836	BYT2	UDEC	No/Yes	1
32845	BYT2	UDEC	Yes/Yes	1
32846	BYT2	SDEC	Yes/Yes	1
32847	BYT2	SDEC	Yes/Yes	1
32848	BYT2	UDEC	Yes/Yes	1
32849	BYT2	SDEC	Yes/Yes	1
32850	BYT2	SDEC	Yes/Yes	1
32851	BYT2	SDEC	Yes/Yes	1
32852	BYT2	SDEC	Yes/Yes	1
32853	BYT2	SDEC	Yes/Yes	1
32854	BYT2	SDEC	Yes/Yes	1
32865	BYT2	UDEC	Yes/Yes	1
32866	BYT2	UDEC	Yes/Yes	1
32867	BYT2	UDEC	Yes/Yes	1
32868	BYT2	UDEC	Yes/Yes	1
32874	BYT2	UDEC	Yes/Yes	1
32875	BYT2	UDEC	Yes/Yes	1

ID No.	Data Length	Data Type	Write / Read	Decimal Place*
32876	BYT2	UDEC	Yes/Yes	1
32877	BYT2	UDEC	Yes/Yes	1
32880	BYT2	UDEC	Yes/Yes	1
32881	BYT2	UDEC	Yes/Yes	1
32882	BYT2	UDEC	Yes/Yes	1
32883	BYT2	UDEC	Yes/Yes	1
32891	BYT2	UDEC	Yes/Yes	1
32892	BYT4	UDEC	Yes/Yes	1
32893	BYT4	UDEC	Yes/Yes	1
32922	BYT2	UDEC	Yes/Yes	1
32925	BYT2	HEX	Yes/Yes	Hex
32926	BYT2	HEX	Yes/Yes	Hex
32927	BYT2	HEX	Yes/Yes	Hex
32928	BYT2	UDEC	Yes/Yes	0.1
32929	BYT2	UDEC	Yes/Yes	0.1
32934	BYT2	UDEC	Yes/Yes	1
32935	BYT2	UDEC	Yes/Yes	0.1
32936	BYT4	HEX	Yes/Yes	Hex
32940	BYT4	SDEC	Yes/Yes	1
32947	BYT4	UDEC	Yes/Yes	1
32952	BYT4	UDEC	Yes/Yes	1
32953	BYT2	HEX	Yes/Yes	Hex
32956	BYT2	UDEC	Yes/Yes	1
32958	BYT2	UDEC	Yes/Yes	1
32959	BYT2	UDEC	Yes/Yes	1
32964	BYT2	UDEC	Yes/Yes	1
32966	BYT2	SDEC	Yes/Yes	1
32967	BYT2	UDEC	Yes/Yes	1
32968	BYT2	UDEC	Yes/Yes	0.1
32978	BYT2	UDEC	Yes/Yes	1
32979	BYT2	UDEC	Yes/Yes	1
32980	BYT2	UDEC	Yes/Yes	1
32981	BYT2	UDEC	Yes/Yes	1
32992	BYT2	UDEC	Yes/Yes	0.1

ID No.	Data Length	Data Type	Write / Read	Decimal Place*
32993	BYT2	UDEC	Yes/Yes	0.1
33700	BYT2	UDEC	Yes/Yes	1
33701	BYT2	UDEC	Yes/Yes	1
33702	BYT2	UDEC	Yes/Yes	1
33703	BYT2	UDEC	Yes/Yes	1
33704	BYT2	UDEC	Yes/Yes	1
33705	BYT2	UDEC	Yes/Yes	1
33706	BYT2	UDEC	Yes/Yes	1
33707	BYT2	UDEC	Yes/Yes	1
33708	BYT2	UDEC	Yes/Yes	1
33709	BYT2	UDEC	Yes/Yes	1
33710	BYT2	UDEC	Yes/Yes	1
33711	BYT2	UDEC	Yes/Yes	1
33712	BYT2	UDEC	Yes/Yes	1
33713	BYT2	UDEC	Yes/Yes	1
33714	BYT2	UDEC	Yes/Yes	1
33721	BYT2	UDEC	Yes/Yes	1
33722	BYT2	UDEC	Yes/Yes	1
33724	BYT2	UDEC	Yes/Yes	1
33725	BYT2	UDEC	Yes/Yes	1
33729	BYT2	UDEC	Yes/Yes	1
33730	BYT2	UDEC	Yes/Yes	1
33731	BYT2	UDEC	Yes/Yes	1
33732	BYT2	UDEC	No/Yes	1
33800	BYT2	UDEC	Yes/Yes	1
33801	BYT2	UDEC	Yes/Yes	1
33802	BYT2	UDEC	Yes/Yes	1
33803	BYT2	UDEC	Yes/Yes	1
33804	BYT2	UDEC	Yes/Yes	1
33805	BYT2	UDEC	Yes/Yes	1
33806	BYT2	UDEC	Yes/Yes	1
33807	BYT2	UDEC	Yes/Yes	1
33808	BYT2	UDEC	Yes/Yes	1
33809	BYT2	UDEC	Yes/Yes	1

ID No.	Data Length	Data Type	Write / Read	Decimal Place*
33810	BYT2	UDEC	Yes/Yes	1
33811	BYT2	UDEC	Yes/Yes	1
33812	BYT2	UDEC	Yes/Yes	1
33813	BYT2	UDEC	Yes/Yes	1
33814	BYT2	UDEC	Yes/Yes	1
33815	BYT2	UDEC	Yes/Yes	1
33816	BYT2	UDEC	Yes/Yes	1
33817	BYT2	UDEC	Yes/Yes	1
33818	BYT2	UDEC	Yes/Yes	1
33819	BYT2	UDEC	Yes/Yes	1
33820	BYT2	UDEC	Yes/Yes	1
33839	BYT2	UDEC	Yes/Yes	1
33840	BYT2	UDEC	Yes/Yes	1
33859	BYT2	UDEC	Yes/Yes	1
33860	BYT2	UDEC	Yes/Yes	1
33869	BYT2	UDEC	Yes/Yes	1
33880	BYT2	UDEC	Yes/Yes	1
33889	BYT2	UDEC	Yes/Yes	1
33890	BYT2	UDEC	Yes/Yes	1
33899	BYT2	UDEC	Yes/Yes	1
34000	BYT2	UDEC	Yes/Yes	1
34001	BYT2	UDEC	Yes/Yes	1
34002	BYT2	UDEC	Yes/Yes	1
34003	BYT2	UDEC	Yes/Yes	1
34004	BYT2	UDEC	Yes/Yes	1
34005	BYT2	UDEC	Yes/Yes	1
34006	BYT2	UDEC	Yes/Yes	1
34007	BYT2	UDEC	Yes/Yes	1
34008	BYT2	UDEC	Yes/Yes	1
34009	BYT2	UDEC	Yes/Yes	1
34010	BYT2	UDEC	Yes/Yes	1
34011	BYT2	UDEC	Yes/Yes	1
34012	BYT2	UDEC	Yes/Yes	1
34013	BYT2	UDEC	Yes/Yes	1

ID No.	Data Length	Data Type	Write / Read	Decimal Place*
34014	BYT2	UDEC	Yes/Yes	1
34015	BYT2	UDEC	Yes/Yes	1
34016	BYT2	UDEC	Yes/Yes	1
34017	BYT2	UDEC	Yes/Yes	1
34018	BYT2	UDEC	Yes/Yes	1
34019	BYT2	UDEC	Yes/Yes	1
34023	BYT2	UDEC	Yes/Yes	1
34025	BYT2	UDEC	Yes/Yes	1
34042	BYT2	UDEC	Yes/Yes	1
34043	BYT2	UDEC	Yes/Yes	0.01
34044	BYT2	UDEC	Yes/Yes	0.01
34045	BYT2	UDEC	Yes/Yes	0.01
34046	BYT2	UDEC	Yes/Yes	0.01
34047	BYT2	UDEC	Yes/Yes	0.01
34048	BYT2	UDEC	Yes/Yes	0.01
34049	BYT2	UDEC	Yes/Yes	0.01
34050	BYT2	UDEC	Yes/Yes	0.1
34051	BYT2	UDEC	Yes/Yes	0.01
34052	BYT2	UDEC	Yes/Yes	0.1
34053	BYT2	UDEC	Yes/Yes	1
34054	BYT2	UDEC	Yes/Yes	0.1
34055	BYT2	UDEC	Yes/Yes	0.1
34056	BYT2	UDEC	Yes/Yes	1
34070	BYT2	UDEC	Yes/Yes	1
34148	BYT2	UDEC	Yes/Yes	0.001
34149	BYT2	UDEC	Yes/Yes	0.1
34164	BYT2	UDEC	Yes/Yes	0.01
34167	BYT2	UDEC	Yes/Yes	0.01
34177	BYT2	UDEC	Yes/Yes	1
34178	BYT2	UDEC	Yes/Yes	1
34179	BYT2	UDEC	Yes/Yes	1
34180	BYT2	UDEC	Yes/Yes	1
34182	BYT4	SDEC	Yes/Yes	1
35000	/* Depends on Text */ 0	ASCII	No/Yes	ASCII

ID No.	Data Length	Data Type	Write / Read	Decimal Place*
35001	/* Depends on Text */ 0	ASCII	No/Yes	ASCII
35002	BYT4	HEX	No/Yes	1
35003	BYT2	HEX	No/Yes	Hex
35004	BYT2	UDEC	No/Yes	0.1
35005	BYT2	UDEC	No/Yes	0.1
35006	BYT2	UDEC	No/Yes	0.1
35007	BYT2	UDEC	No/Yes	0.1
35008	BYT2	UDEC	No/Yes	0.1
35009	BYT2	UDEC	No/Yes	0.1
35010	BYT2	UDEC	No/Yes	0.1
35011	BYT2	UDEC	No/Yes	1
36000	BYT2	UDEC	No/Yes	1
36001	BYT2	UDEC	No/Yes	1
36002	BYT4	SDEC	No/Yes	1
36003	BYT4	SDEC	No/Yes	1
36004	BYT4	UDEC	No/Yes	1
36005	BYT4	UDEC	No/Yes	1
36006	BYT2	UDEC	No/Yes	1
36007	BYT2	UDEC	No/Yes	1
36008	BYT2	UDEC	No/Yes	1
36009	BYT2	UDEC	No/Yes	1
36010	BYT2	UDEC	No/Yes	1
36011	BYT2	UDEC	No/Yes	1
36012	BYT4	UDEC	No/Yes	1
36013	BYT4	UDEC	No/Yes	1
36019	BYT2	UDEC	Yes/Yes	1
36020	BYT2	UDEC	Yes/Yes	1
36021	BYT2	UDEC	Yes/Yes	1
36022	BYT2	UDEC	Yes/Yes	1
36023	BYT2	UDEC	Yes/Yes	1
36100	BYT4	UDEC	Yes/Yes	1
36101	BYT4	UDEC	Yes/Yes	1
36102	BYT4	UDEC	Yes/Yes	1
36103	BYT4	UDEC	Yes/Yes	1

ID No.	Data Length	Data Type	Write / Read	Decimal Place*
36104	BYT4	UDEC	Yes/Yes	1

*Note: If the decimal place of ID is 0.0001, please set [Right of decimal Pt.] of the object to "4".

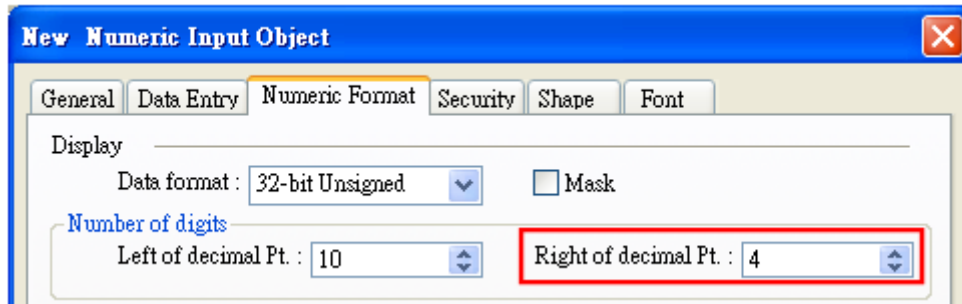



Wiring Diagram:





The following represents the view of HMI & PLC.

RS-232



eMT3000 series

COM1 RS232 9P D-Sub Female	COM3 RS232 9P D-Sub Female		X5 Port RS232 9P D-Sub Male
2 RX	8 RX		2 TX
3 TX	7 TX		3 RX
5 GND	5 GND		5 GND
			

MT6000/8000 series except MT6050i/MT8050i

COM1 RS232 9P D-Sub Female	COM2 RS232 9P D-Sub Female	COM3 RS232 9P D-Sub Male	X5 Port RS232 9P D-Sub Male
2 RX	6 RX	8 RX	2 TX
3 TX	4 TX	7 TX	3 RX
5 GND	5 GND	5 GND	5 GND
			

MT6050i/MT8050i

COM1 RS232 9P D-Sub Female			X5 Port RS232 9P D-Sub Male
9 RX			2 TX
6 TX			3 RX
5 GND			5 GND
			



The following represents the view of HMI & PLC.

RS485 2W



eMT3000 series

COM1 RS485 2W 9P D-Sub Male	COM3 RS485 2W 9P D-Sub Male		X5 Port RS485 2W 9P D-Sub Male
1 RX-	6 Data-		4 RS485-
2 RX+	9 Data+		1 RS485+
5 GND	5 GND		5 GND
			

MT6000/8000 series except MT6050i/MT8050i

COM1 RS485 2W 9P D-Sub Male	COM3 RS485 2W 9P D-Sub Male		X5 Port RS485 2W 9P D-Sub Male
1 RX-	6 Data-		4 RS485-
2 RX+	9 Data+		1 RS485+
5 GND	5 GND		5 GND
			

MT6050i/MT8050i

COM1 RS485 2W 9P D-Sub Female	COM3 RS485 2W 9P D-Sub Female		X5 Port RS485 2W 9P D-Sub Male
1 RX-	7 Data-		4 RS485-
2 RX+	8 Data+		1 RS485+
5 GND	5 GND		5 GND
			

Driver Version:

Version	Date	Description
V1.00	Mar/27/2012	Driver released.
V1.10	Jul/20/2012	The newly supported software SSTS_PAS_V2.3 supports ID address.

TECHSOFT Intelligent Servo

Supported Series: Intelligent Servo supports IDM640, IDM240.

Website: <http://www.techsoftmotion.com>

HMI Setting:

Parameters	Recommended	Options	Notes
PLC type	Intelligent Servo		
PLC I/F	RS232		
Baud rate	9600	9600~115200	
Data bits	8	7 or 8	
Parity	None	Even, Odd, None	
Stop bits	1	1 or 2	
PLC sta. no.	1		



Device Address:

Bit/Word	Device type	Format	Range	Memo
W	Register_32bit	HHHH	0 ~ 270f	32bit signed
DW	Register_H	HHHH	0 ~ 270f	32bit Hex
W	UPD	HHHHH	0 ~ 1869f	Send UDP command
W	STOP	HHHHH	0 ~ 1869f	Send STOP command





Wiring Diagram:

The following represents the view of HMI & PLC.



eMT3000 series

COM1 RS232 9P D-Sub Female	COM3 RS232 9P D-Sub Female		Servo RS232 D-Sub Male
2 RX	8 RX		2 TD
3 TX	7 TX		3 RD
5 GND	5 GND		5 GND
			

MT6000/8000 series except MT6050i/MT8050i

COM1 RS232 9P D-Sub Female	COM2 RS232 9P D-Sub Female	COM3 RS232 9P D-Sub Male	Servo RS232 D-Sub Male
2 RX	6 RX	8 RX	2 TD
3 TX	4 TX	7 TX	3 RD
5 GND	5 GND	5 GND	5 GND
			

MT6050i/MT8050i

COM1 RS232 9P D-Sub Female			Servo RS232 D-Sub Male
9 RX			2 TD
6 TX			3 RD
5 GND			5 GND
			

Driver Version:

Version	Date	Description
V1.00	Nov/06/2009	Driver released.

TECO Inverter

Supported Series: TECO Inverter series, 7300CV model.

HMI Setting:

Parameters	Recommended	Options	Notes
PLC type	TECO Inverter		
PLC I/F	RS232	RS232/RS485	
Baud rate	38400		
Data bits	8		
Parity	None		
Stop bits	1		
PLC sta. no.	1		

Device Address:

Bit/Word	Device type	Format	Range	Memo
B	0x	DDDDD	1 ~ 65535	Output Bit
B	1x	DDDDD	1 ~ 65535	Input Bit (read only)
B	3x_Bit	DDDDDdd	100 ~ 6553515	Input Register Bit (read only)
B	4x_Bit	DDDDDdd	100 ~ 6553515	Output Register Bit
B	6x_Bit	DDDDDdd	100 ~ 6553515	
B	0x (0x0f)	DDDDD	1 ~ 65535	Write Multiple Coils
W	3x	DDDDD	1 ~ 65535	Input Register (read only)
W	4x	DDDDD	1 ~ 65535	Output Register
DW	5x	DDDDD	1 ~ 65535	4x Double Word Swap
W	6x	DDDDD	1 ~ 65535	4x Single Word Write

Wiring Diagram:

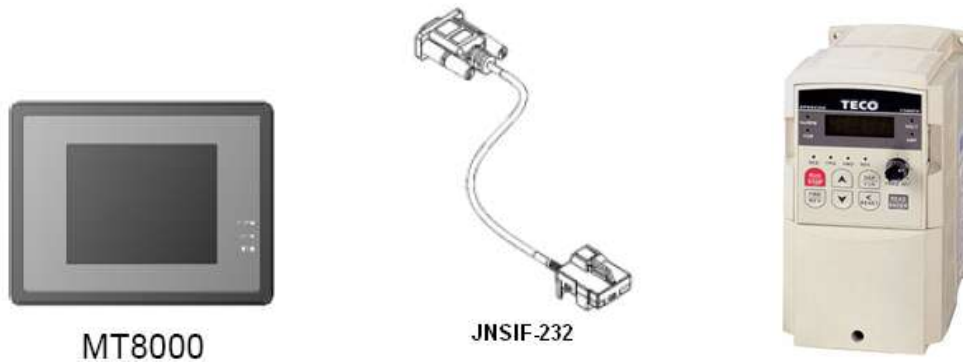

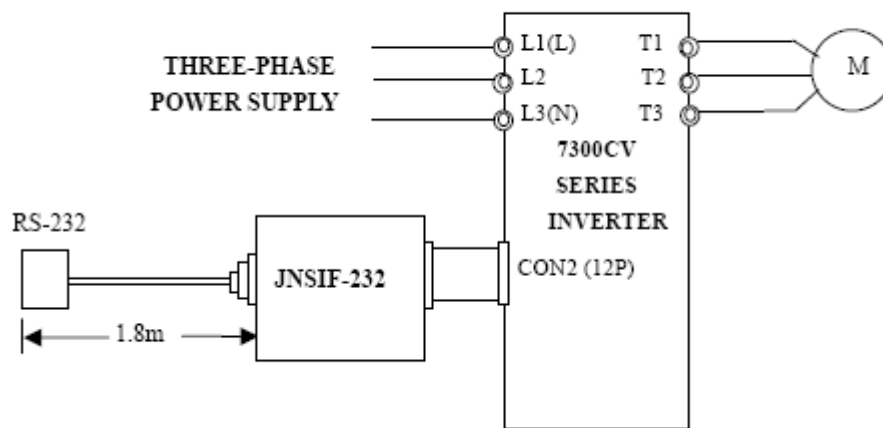

JNSIF-232 Wiring Diagram:





The following represents the view of HMI & PLC.

9P D-Sub to 9P D-Sub:

eMT3000 series

COM1 RS232 9P D-Sub Female			RS232 9P D-Sub Male
2 RX			2 TX
3 TX			3 RX
5 GND			5 GND
7 RTS			7 VCC
			

MT6000/8000 series except MT6050i/MT8050i

COM1 RS232 9P D-Sub Female			RS232 9P D-Sub Male
2 RX			2 TX
3 TX			3 RX
5 GND			5 GND
7 RTS			7 VCC
			

Driver Version:

Version	Date	Description
V1.00	Jul/27/2009	Driver released.

TECO TP02 Series

Supported Series: TAIAN TP02 series

Website: <http://www.taian-technology.com>

HMI Setting:

Parameters	Recommended	Options	Notes
PLC type	TECO TP02 Series		
PLC I/F	RS485 4W/2W	RS485 4W/2W	MMI 422 port: 4W; RS485 terminals: 2W
Baud rate	19200	9600, 19200, 38400	
Data bits	7	7, 8	
Parity	Even	Even, Odd, None	
Stop bits	2	1, 2	
PLC sta. no.	1	0-255	

PLC Setting:

RS422 port: WS041=120, WS042=1;

RS485 terminals: WS044=120, WS045=1.

Device Address:



Bit/Word	Device type	Format	Range	Memo
B	X	DDD	1 ~ 384	Input relay
B	Y	DDD	1 ~ 384	Output relay
B	C	DDDD	1 ~ 2048	Auxiliary relay
W	X	DDD	1 ~ 369	Input register (must be 1 or a multiple of plus 1)
W	Y	DDD	1 ~ 369	Output register (must be 1 or a multiple of plus 1)
W	V	DDDD	1 ~ 1024	Auxiliary register
W	D	DDDD	1 ~ 2048	Auxiliary register
W	WS	DDD	1 ~ 128	System register
W	C	DDDD	1 ~ 2033	Auxiliary relay register (must be 1 or a multiple of plus 1)
W	WC	DDD	1 ~ 912	Constant register

Wiring Diagram:



The following represents the view of HMI & PLC.

TP02 Series MMI RS422 port : 9P D-Sub to 9P D-Sub



eMT3000 series

COM1 RS485 4W 9P D-Sub Male			RS485 4W 9P D-Sub Male
1 RX-			8 TX-
2 RX+			3 TX+
3 TX-			7 RX-
4 TX+			2 RX+
5 GND			
			

MT6000/8000 series except MT6050i/MT8050i

COM1 RS485 4W 9P D-Sub Male			RS485 4W 9P D-Sub Male
1 RX-			8 TX-
2 RX+			3 TX+
3 TX-			7 RX-
4 TX+			2 RX+
5 GND			
			



MT6050i/MT8050i

COM1 RS485 4W 9P D-Sub Female			RS485 4W 9P D-Sub Male
1 RX-			8 TX-
2 RX+			3 TX+
3 TX-			7 RX-
4 TX+			2 RX+
5 GND			
			



The following represents the view of HMI & PLC.

TP02 Series RS485 Terminal : 9P D-Sub to 9P D-Sub



eMT3000 series

COM1 RS485 2W 9P D-Sub Male	COM3 RS485 2W 9P D-Sub Male		RS485 2W Terminal
1 RX-	6 Data-		T/R-
2 RX+	9 Data+		T/R+
5 GND	5 GND		
			

MT6000/8000 series except MT6050i/MT8050i

COM1 RS485 2W 9P D-Sub Male	COM3 RS485 2W 9P D-Sub Male		RS485 2W Terminal
1 RX-	6 Data-		T/R-
2 RX+	9 Data+		T/R+
5 GND	5 GND		
			

MT6050i/MT8050i

COM1 RS485 2W 9P D-Sub Female	COM3 RS485 2W 9P D-Sub Female		RS485 2W Terminal
1 RX-	7 Data-		T/R-
2 RX+	8 Data+		T/R+
5 GND	5 GND		
			

Driver Version:

Version	Date	Description
V1.10	Jan/25/2010	

TECO TP03 Series

Supported Series: TECO (TAIAN TP03) series PLC.

Website: <http://www.teco.com.tw/sa/en/>

HMI Setting:

Parameters	Recommended	Options	Notes
PLC type	TECO TP03 Series		
PLC I/F	RS485 4W		
Baud rate	19200	9600, 19200	
Data bits	8	8	
Parity	None	Even, Odd, None	
Stop bits	2	1	
PLC sta. no.	1	1-31	



Device Address:

Bit/Word	Device type	Format	Range	Memo
B	C	DDDD	0 ~ 9999	
B	M	DDDD	0 ~ 9999	
B	S	DDDD	0 ~ 9999	
B	T	DDDD	0 ~ 9999	
B	X	OOO	0 ~ 377	
B	Y	OOO	0 ~ 377	
W	D	DDDD	0 ~ 9999	
W	V	DDDD	0 ~ 9999	
W	Z	DDDD	0 ~ 9999	
W	T_Curent	DDDD	0 ~ 9999	
W	C_Curent	DDDD	0 ~ 9999	
W	T_Preset	DDDD	0 ~ 9999	
W	C_Preset	DDDD	0 ~ 9999	



Wiring Diagram:

The following represents the view of HMI & PLC.



eMT3000 series

COM1 RS485 4W 9P D-Sub Male			RS485 4W 8P Mini-DIN Male
1 RX-			4 TX-
2 RX+			7 TX+
3 TX-			1 RX-
4 TX+			2 RX+
5 GND			3 GND
			

MT6000/8000 series except MT6050i/MT8050i

COM1 RS485 4W 9P D-Sub Male			RS485 4W 8P Mini-DIN Male
1 RX-			4 TX-
2 RX+			7 TX+
3 TX-			1 RX-
4 TX+			2 RX+
5 GND			3 GND
			

MT6050i/MT8050i

COM1 RS485 4W 9P D-Sub Female			RS485 4W 8P Mini-DIN Male
1 RX-			4 TX-
2 RX+			7 TX+
3 TX-			1 RX-
4 TX+			2 RX+
5 GND			3 GND
			

Driver Version:

Version	Date	Description
V1.10	Nov/13/2009	

TINHAO

Website: www.chinastrand.com

HMI Setting:

Parameters	Recommended	Options	Notes
PLC type	TINHAO		
PLC I/F	RS485 2W		
Baud rate	19200		
Data bits	8		
Parity	None		
Stop bits	1		
PLC sta. no.	1		

Device Address:



Bit/Word	Device type	Format	Range	Memo
W	Commend1	DDD	0 ~ 255	
W	Commend2	DDD	0 ~ 255	
W	Commend3	DDD	0 ~ 255	
W	Commend4	DDD	0 ~ 255	
W	Commend5	DDD	0 ~ 255	
W	Commend6	DDD	0 ~ 255	
W	Commend7	DDD	0 ~ 255	
W	Commend8	DDD	0 ~ 255	
W	Commend9	DDD	0 ~ 255	
W	Commend10	DDD	0 ~ 255	
W	Commend11	DDD	0 ~ 255	
W	Commend12	DDD	0 ~ 255	
W	Commend13	DDD	0 ~ 255	
W	Commend14	DDD	0 ~ 255	
W	Commend15	DDD	0 ~ 255	
W	Commend16	DDD	0 ~ 255	
W	Commend17	DDD	0 ~ 255	
W	Commend18	DDD	0 ~ 255	

Bit/Word	Device type	Format	Range	Memo
W	Commend19	DDD	0 ~ 255	
W	Commend20	DDD	0 ~ 255	
W	Commend21	DDD	0 ~ 255	
W	Commend22	DDD	0 ~ 255	



Wiring Diagram:

The following represents the view of HMI & PLC.



eMT3000 series

COM1 RS485 2W 9P D-Sub Male	COM3 RS485 2W 9P D-Sub Male		RS485 terminal
1 RX-	6 Data-		D-
2 RX+	9 Data+		D+
5 GND	5 GND		
			

MT6000/8000 series except MT6050i/MT8050i

COM1 RS485 2W 9P D-Sub Male	COM3 RS485 2W 9P D-Sub Male		RS485 terminal
1 RX-	6 Data-		D-
2 RX+	9 Data+		D+
5 GND	5 GND		
			

MT6050i/MT8050i

COM1 RS485 2W 9P D-Sub Female	COM3 RS485 2W 9P D-Sub Female		RS485 terminal
1 RX-	7 Data-		D-
2 RX+	8 Data+		D+
5 GND	5 GND		
			

Driver Version:

Version	Date	Description
V1.00	Oct/14/2011	Driver released.

Toptek Topvert

Supported Series: TOPVERT G1/H1/P1 series.

Website: <http://www.toptek.biz/>

HMI Setting:

Parameters	Recommended	Options	Notes
PLC type	Toptek Topvert		
PLC I/F	RS485 2W		
Baud rate	9600		
Data bits	7		
Parity	None		
Stop bits	2		
PLC sta. no.	1		

Online simulator	YES	Broadcast command	YES
Extend address mode	YES	Broadcast station no.	0

PLC Setting:

Communication mode	Pr 7-15 = 0 (7, N, 2 ASCII)
--------------------	-----------------------------

Device Address:

Bit/Word	Device type	Format	Range	Memo
B	PR_Bit	DDDDDDdd	0 ~ 6553515	G=Groups, F=Function no. dd=0~15 bit no.
W	PR	DDDDD	0 ~ 65535	G=Groups, F=Function no.

Note:

Max.read-command size (words): 16

Max.write-command size (words): 1

For G1/H1/P1 Series Inverter, if standard parameter address is in decimal= $100 \cdot G + F$:

G=Group (parameter group code 0~9); F=Function no. (parameter number 0~99)



For example: Pr5-20 (decimal Dec.) parameter address is expressed as $100 \cdot 5 + 20 = 520$.

Parameter (PrX-XX)	Address (decimal)
0-00	$0 \cdot 100 + 0 = 0$
0-14	$0 \cdot 100 + 14 = 14$
1-00	$1 \cdot 100 + 0 = 100$



Wiring Diagram:

The following represents the view of HMI & PLC.



eMT3000 series

COM1 RS485 2W 9P D-Sub Male	COM3 RS485 2W 9P D-Sub Male		RS485 2W Terminal
1 RX-	6 Data-		SG-
2 RX+	9 Data+		SG+
5 GND	5 GND		
			

MT6000/8000 series except MT6050i/MT8050i

COM1 RS485 2W 9P D-Sub Male	COM3 RS485 2W 9P D-Sub Male		RS485 2W Terminal
1 RX-	6 Data-		SG-
2 RX+	9 Data+		SG+
5 GND	5 GND		
			

MT6050i/MT8050i

COM1 RS485 2W 9P D-Sub Female	COM3 RS485 2W 9P D-Sub Female		RS485 2W Terminal
1 RX-	7 Data-		SG-
2 RX+	8 Data+		SG+
5 GND	5 GND		
			

Driver Version:

Version	Date	Description
V1.00	Dec/08/2010	Driver released.

TOSHIBA T Series

Supported Series: Toshiba T series, S2E.

Website: <http://www.tic.toshiba.com>

HMI Setting:

Parameters	Recommended	Options	Notes
PLC type	TOSHIBA T Series		
PLC I/F	RS232	RS232/RS485	In accordance with PLC port
Baud rate	9600	9600, 19200, 38400, 57600, 115200	
Data bits	8	7,8	
Parity	Odd	Even, Odd, None	
Stop bits	1	1, 2	
PLC sta. no.	0	0-255	Must be same as the PLC setting

Online simulator	YES	Extend address mode	YES
------------------	-----	---------------------	-----

PLC Setting:

Communication mode	Must set PLC node ID
--------------------	----------------------

Device Address:

Bit/Word	Device type	Format	Range	Memo
B	X	DDDDh	0 ~ 4095f	Input Bit
B	Y	DDDDh	0 ~ 4095f	Output Bit
B	R	DDDDh	0 ~ 8191f	Auxiliary Bit
B	S	DDDDh	0 ~ 4095f	Special Bit
B	L	DDDDh	0 ~ 4095f	
B	Z	DDDDh	0 ~ 8191f	
W	T	DDD	0 ~ 999	Timer Register
W	C	DDD	0 ~ 511	Counter Register
W	D	DDDD	0 ~ 8191	Data Memory



Bit/Word	Device type	Format	Range	Memo
W	SW	DDD	0 ~ 255	Special Register
W	XW	DDD	0 ~ 255	Input Register
W	YW	DDD	0 ~ 255	Output Register
W	RW	DDD	0 ~ 999	Auxiliary Register
W	LW	DDD	0 ~ 255	
W	W	DDDD	0 ~ 1023	
W	F	DDDD	0 ~ 8191	

Wiring Diagram:





The following represents the view of HMI & PLC.

Toshiba T1 PRG RS232 : 9P D-Sub to 8P Mini-DIN



eMT3000 series

COM1 RS232 9P D-Sub Female	COM3 RS232 9P D-Sub Female		RS232 8P Mini-DIN Male
2 RX	8 RX		6 TXD
3 TX	7 TX		8 RXD
5 GND	5 GND		5 GND
			4 RTS
			7 CTS
			circuit
			

MT6000/8000 series except MT6050i/MT8050i

COM1 RS232 9P D-Sub Female	COM2 RS232 9P D-Sub Female	COM3 RS232 9P D-Sub Male	RS232 8P Mini-DIN Male
2 RX	6 RX	8 RX	6 TXD
3 TX	4 TX	7 TX	8 RXD
5 GND	5 GND	5 GND	5 GND
			4 RTS
			7 CTS
			circuit
			



MT6050i/MT8050i

COM1 RS232 9P D-Sub Female			RS232 8P Mini-DIN Male
9 RX			6 TXD
6 TX			8 RXD
5 GND			5 GND
			4 RTS
			7 CTS
			circuit
			





The following represents the view of HMI & PLC.

Toshiba T2 PRG RS232 : 9P D-Sub to 9P D-Sub



eMT3000 series

COM1 RS232 9P D-Sub Female	COM3 RS232 9P D-Sub Female		RS232 9P D-Sub Male
2 RX	8 RX		3 TXD
3 TX	7 TX		2 RXD
5 GND	5 GND		5 GND
			7 RTS
			8 CTS
			circuit
			

MT6000/8000 series except MT6050i/MT8050i

COM1 RS232 9P D-Sub Female	COM2 RS232 9P D-Sub Female	COM3 RS232 9P D-Sub Male	RS232 9P D-Sub Male
2 RX	6 RX	8 RX	3 TXD
3 TX	4 TX	7 TX	2 RXD
5 GND	5 GND	5 GND	5 GND
			7 RTS
			8 CTS
			circuit
			

MT6050i/MT8050i

COM1 RS232 9P D-Sub Female			RS232 9P D-Sub Male
9 RX			3 TXD
6 TX			2 RXD
5 GND			5 GND
			7 RTS
			8 CTS
			circuit
			

The following represents the view of HMI & PLC.

Toshiba T2 LINK Port RS485 4W : 9P D-Sub to 15P D-Sub

eMT3000 series

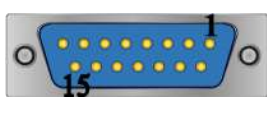
COM1 RS485 4W 9P D-Sub Male			RS485 4W 15P D-Sub Male
1 RX-			11 TXB
2 RX+			3 TXA
3 TX-			10 RXB
4 TX+			2 RXA
5 GND			7 SG
			5 RTSA
			4 CTSA
			circuit
			13 RTSB
			12 CTSB
			circuit
			

MT6000/8000 series except MT6050i/MT8050i

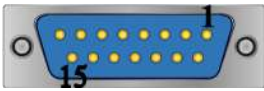
COM1 RS485 4W 9P D-Sub Male			RS485 4W 15P D-Sub Male
1 RX-			11 TXB
2 RX+			3 TXA
3 TX-			10 RXB
4 TX+			2 RXA
5 GND			7 SG
			5 RTSA
			4 CTSA
			13 RTSB
			12 CTSB
			circuit
			circuit
			

MT6050i/MT8050i

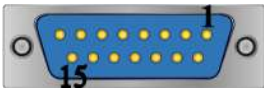
COM1 RS485 4W 9P D-Sub Female			RS485 4W 15P D-Sub Male
1 RX-			11 TXB
2 RX+			3 TXA
3 TX-			10 RXB
4 TX+			2 RXA
5 GND			7 SG
			5 RTSA
			4 CTSA
			13 RTSB
			12 CTSB
			circuit
			circuit
			

Driver Version:

Version	Date	Description
V1.20	May/13/2011	TOSHIBA T Series driver can now correctly read and write "L", "LW", "F" address types.

TOSHIBA VF-S11

Supported Series: Toshiba Invertor Protocol (ASCII code).

HMI Setting:

Parameters	Recommended	Options	Notes
PLC type	TOSHIBA VF-S11		
PLC I/F	RS485 2W	RS422, RS485	
Baud rate	9600	9600, 19200	
Data bits	8	7 or 8	
Parity	Even	Even, Odd, None	
Stop bits	1	1 or 2	
PLC sta. no.	0	0-99	

Online simulator	YES	Extend address mode	YES
Broadcast command	YES		

Device Address:

Bit/Word	Device type	Format	Range	Memo
B	Cmd. No B	HHHHdd	0 ~ 270f15	
W	Cmd. No	HHHH	0 ~ ffff	Parameters and data memory

Wiring Diagram:

Note:

Before connecting with VF-S11, make sure the SW1 of both sides are in the correct position. (SW1: wiring method selector switch)

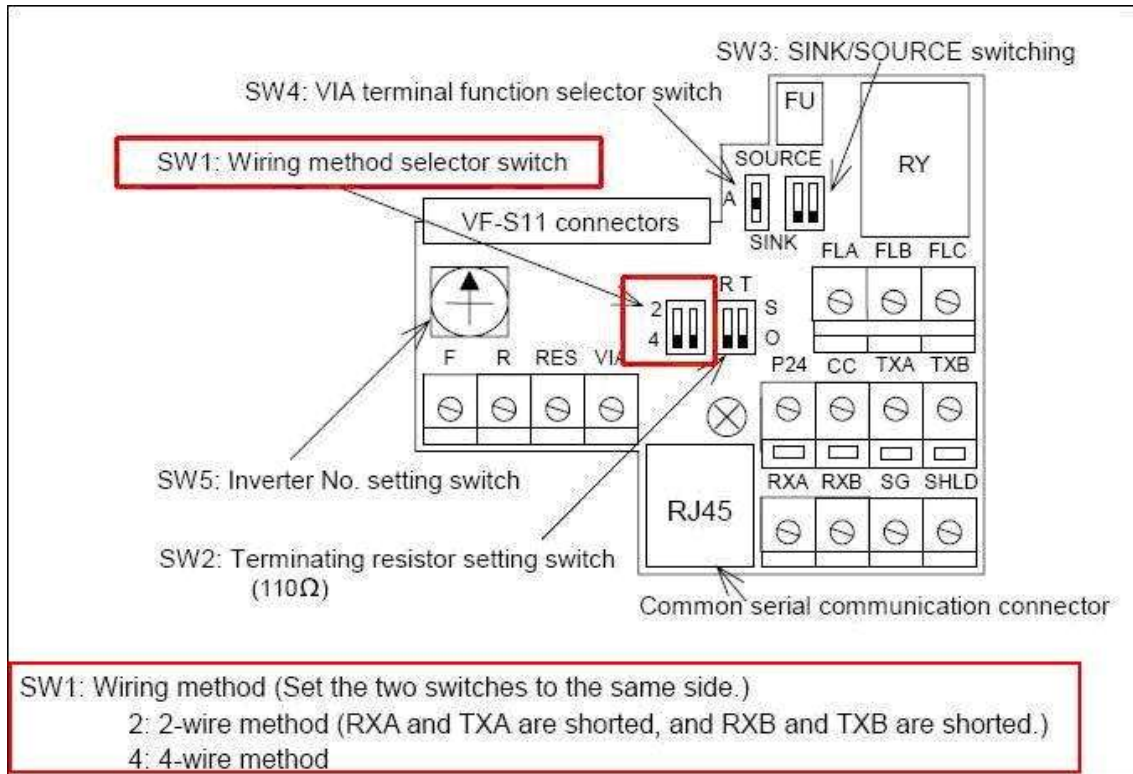

RS-485

The following represents the view of HMI & PLC.



eMT3000 series

COM1 RS485 2W 9P D-Sub Male	COM3 RS485 2W 9P D-Sub Male		RS485 2W 8P RJ45 Male
1 RX-	6 Data-		5 Data-
2 RX+	9 Data+		4 Data+
5 GND	5 GND		8 Gnd

MT6000/8000 series except MT6050i/MT8050i

COM1 RS485 2W 9P D-Sub Male	COM3 RS485 2W 9P D-Sub Male		RS485 2W 8P RJ45 Male
1 RX-	6 Data-		5 Data-
2 RX+	9 Data+		4 Data+
5 GND	5 GND		8 Gnd

MT6050i/MT8050i

COM1 RS485 2W 9P D-Sub Female	COM3 RS485 2W 9P D-Sub Female		RS485 2W 8P RJ45 Male
1 RX-	7 Data-		5 Data-
2 RX+	8 Data+		4 Data+
5 GND	5 GND		8 Gnd
			

Driver Version:

Version	Date	Description
V1.20	Aug/31/2009	

TOSHIBA MACHINE Provisor TC200

Supported Series: TOSHIBA MACHINE CO., JAPAN

WebSite: <http://www.toshiba-machine.co.jp>

HMI Setting:

Parameters	Recommended	Options	Notes
PLC type	TOSHIBA MACHINE Provisor TC200		
PLC I/F	RS232	RS232	In accordance with PLC port
Baud rate	9600	9600, 19200	
Data bits	8	7,8	
Parity	None	Even, Odd, None	
Stop bits	1	1, 2	

Device Address:



Bit/Word	Device type	Format	Range	Memo
B	R_bit	HHHh	0 ~ ffff	h : Bit no.(0~f)
B	X_bit	HHHh	0 ~ ffff	h : Bit no.(0~f)
B	Y_bit	HHHh	0 ~ ffff	h : Bit no.(0~f)
B	L_bit	HHHh	0 ~ ffff	h : Bit no.(0~f)
B	G_bit	HHHh	0 ~ ffff	h : Bit no.(0~f)
B	H_bit	HHHh	0 ~ ffff	h : Bit no.(0~f)
B	T_bit	HHHh	0 ~ ffff	h : Bit no.(0~f)
B	C_bit	HHHh	0 ~ ffff	h : Bit no.(0~f)
B	S_bit	HHHh	0 ~ ffff	h : Bit no.(0~f)
B	E_bit	HHHh	0 ~ ffff	h : Bit no.(0~f)
W	P	HHH	0 ~ fff	
W	V	HHH	0 ~ fff	
W	X	HHH	0 ~ fff	
W	Y	HHH	0 ~ fff	
W	D	HHH	0 ~ fff	
W	R	HHH	0 ~ fff	
W	L	HHH	0 ~ fff	
W	B	HHH	0 ~ fff	
W	G	HHH	0 ~ fff	

Bit/Word	Device type	Format	Range	Memo
W	H	HHH	0 ~ fff	
W	T	HHH	0 ~ fff	
W	C	HHH	0 ~ fff	
W	S	HHH	0 ~ fff	
W	E	HHH	0 ~ fff	



Wiring Diagram:

The following represents the view of HMI & PLC.

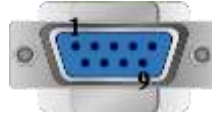

eMT3000 series

COM1 RS232 9P D-Sub Female	COM3 RS232 9P D-Sub Female		TC mini series RS232 9P D-Sub Male
2 RX	8 RX		2 TXD
3 TX	7 TX		3 RXD
5 GND	5 GND		5 GND
			7 RTS
			9 CTS
			circuit
			

MT6000/8000 series except MT6050i/MT8050i

COM1 RS232 9P D-Sub Female	COM2 RS232 9P D-Sub Female	COM3 RS232 9P D-Sub Male	TC mini series RS232 9P D-Sub Male
2 RX	6 RX	8 RX	2 TXD
3 TX	4 TX	7 TX	3 RXD
5 GND	5 GND	5 GND	5 GND
			7 RTS
			9 CTS
			circuit
			

MT6050i/MT8050i

COM1 RS232 9P D-Sub Female			TC mini series RS232 9P D-Sub Male
9 RX			2 TXD
6 TX			3 RXD
5 GND			5 GND
			7 RTS
			9 CTS
			circuit
			

Driver Version:

Version	Date	Description
V1.10	Aug/17/2012	Added register: B,G,H,T,C,S,F.

Trio MODBUS RTU, TCP/IP

Website : <http://www.triomotion.com>

HMI Setting:

Parameters	Recommended	Options	Notes
PLC type	Trio MODBUS RTU, TCP/IP		
PLC I/F	RS485	RS232/RS485/Ethernet	
Baud rate	9600	9600~115200	
Data bits	8	7, 8	
Parity	Even	Even, Odd, None	
Stop bits	1	1, 2	
Port no.	502		
PLC sta. no.	1	0-255	

Online simulator	YES	Broadcast command	YES
Extend address mode	YES		

PLC Setting:

Communication mode	Modbus RTU protocol
PLC Mode	4 (16bit signed integer)

Device Address:



Bit/Word	Device type	Format	Range	Memo
B	VR_Bit	DDDDdd	0 ~ 102315	
B	Table_Bit	DDDDDDdd	0 ~ 3199915	
W	VR	DDDD	0 ~ 1023	
W	Table	DDDDD	0 ~ 31999	

Wiring Diagram:





The following represents the view of HMI & PLC.3

Trio : RS232



eMT3000 series

COM1 RS232 9P D-Sub Female	COM3 RS232 9P D-Sub Female		RS232 9P D-Sub Male
2 RX	8 RX		TXD
3 TX	7 TX		RXD
5 GND	5 GND		GND
			RTS
			CTS
			circuit
			

MT6000/8000 series except MT6050i/MT8050i

COM1 RS232 9P D-Sub Female	COM2 RS232 9P D-Sub Female	COM3 RS232 9P D-Sub Male	RS232 9P D-Sub Male
2 RX	6 RX	8 RX	TXD
3 TX	4 TX	7 TX	RXD
5 GND	5 GND	5 GND	GND
			RTS
			CTS
			circuit
			



MT6050i/MT8050i

COM1 RS232 9P D-Sub Female			RS232 9P D-Sub Male
9 RX			TXD
6 TX			RXD
5 GND			GND
			RTS
			CTS
			circuit
			



The following represents the view of HMI & PLC.

Trio : RS485 4W



eMT3000 series

COM1 RS485 4W 9P D-Sub Male			RS485 4W 9P D-Sub Male
1 RX-			TX-
2 RX+			TX+
3 TX-			RX-
4 TX+			RX+
5 GND			GND
			

MT6000/8000 series except MT6050i/MT8050i

COM1 RS485 4W 9P D-Sub Male			RS485 4W 9P D-Sub Male
1 RX-			TX-
2 RX+			TX+
3 TX-			RX-
4 TX+			RX+
5 GND			GND
			

MT6050i/MT8050i

COM1 RS485 4W 9P D-Sub Female			RS485 4W 9P D-Sub Male
1 RX-			TX-
2 RX+			TX+
3 TX-			RX-
4 TX+			RX+
5 GND			GND
			



The following represents the view of HMI & PLC.

Trio : RS485 2W



eMT3000 series

COM1 RS485 2W 9P D-Sub Male	COM3 RS485 2W 9P D-Sub Male		RS485 2W 9P D-Sub Male
1 RX-	6 Data-		D-
2 RX+	9 Data+		D+
5 GND	5 GND		GND
			

MT6000/8000 series except MT6050i/MT8050i

COM1 RS485 2W 9P D-Sub Male	COM3 RS485 2W 9P D-Sub Male		RS485 2W 9P D-Sub Male
1 RX-	6 Data-		D-
2 RX+	9 Data+		D+
5 GND	5 GND		GND
			

MT6050i/MT8050i

COM1 RS485 2W 9P D-Sub Female	COM3 RS485 2W 9P D-Sub Female		RS485 2W 9P D-Sub Male
1 RX-	7 Data-		D-
2 RX+	8 Data+		D+
5 GND	5 GND		GND
			

Direct connect (crossover cable):

HMI RJ45 Male	Wire Color	PLC RJ45 Male
1 TX+	White/Orange	3 RX+
2 TX-	Orange	6 RX-
3 RX+	White/Green	1 TX+
4 BD4+	Blue	4 BD4+
5 BD4-	White/Blue	5 BD4-
6 RX-	Green	2 TX-
7 BD3+	White/Brown	7 BD3+
8 BD3-	Brown	8 BD3-



Through a hub:

HMI RJ45 Male	Wire Color	PLC RJ45 Male
1 TX+	White/Orange	1 TX+
2 TX-	Orange	2 TX-
3 RX+	White/Green	3 RX+
4 BD4+	Blue	4 BD4+
5 BD4-	White/Blue	5 BD4-
6 RX-	Green	6 RX-
7 BD3+	White/Brown	7 BD3+
8 BD3-	Brown	8 BD3-



Driver Version:

Version	Date	Description
V1.00	May/27/2011	Driver released.

Trio MODBUS RTU, TCP/IP (Mode 7)

Website : <http://www.triomotion.com>

HMI Setting:

Parameters	Recommended	Options	Notes
PLC type	Trio MODBUS RTU, TCP/IP (Mode 7)		
PLC I/F	RS485	RS232/RS485/Ethernet	
Baud rate	9600	9600~115200	
Data bits	8	7, 8	
Parity	Even	Even, Odd, None	
Stop bits	1	1, 2	
Port no.	502		
PLC sta. no.	1	0-255	

Online simulator	YES	Broadcast command	YES
Extend address mode	YES		

PLC Setting:

Communication mode	Modbus RTU protocol
PLC 模式	7 (IEEE floating point)

Device Address:



Bit/Word	Device type	Format	Range	Memo
B	VR_Bit	DDDDdd	0 ~ 102331	
B	Table_Bit	DDDDDDdd	0 ~ 3199931	
W	VR	DDDD	0 ~ 1023	
W	Table	DDDDD	0 ~ 31999	

Wiring Diagram:





The following represents the view of HMI & PLC.3

Trio : RS232



eMT3000 series

COM1 RS232 9P D-Sub Female	COM3 RS232 9P D-Sub Female		RS232 9P D-Sub Male
2 RX	8 RX		TXD
3 TX	7 TX		RXD
5 GND	5 GND		GND
			RTS
			CTS
			circuit
			

MT6000/8000 series except MT6050i/MT8050i

COM1 RS232 9P D-Sub Female	COM2 RS232 9P D-Sub Female	COM3 RS232 9P D-Sub Male	RS232 9P D-Sub Male
2 RX	6 RX	8 RX	TXD
3 TX	4 TX	7 TX	RXD
5 GND	5 GND	5 GND	GND
			RTS
			CTS
			circuit
			



MT6050i/MT8050i

COM1 RS232 9P D-Sub Female			RS232 9P D-Sub Male
9 RX			TXD
6 TX			RXD
5 GND			GND
			RTS
			CTS
			circuit
			



The following represents the view of HMI & PLC.

Trio : RS485 4W



eMT3000 series

COM1 RS485 4W 9P D-Sub Male			RS485 4W 9P D-Sub Male
1 RX-			TX-
2 RX+			TX+
3 TX-			RX-
4 TX+			RX+
5 GND			GND
			

MT6000/8000 series except MT6050i/MT8050i

COM1 RS485 4W 9P D-Sub Male			RS485 4W 9P D-Sub Male
1 RX-			TX-
2 RX+			TX+
3 TX-			RX-
4 TX+			RX+
5 GND			GND
			

MT6050i/MT8050i

COM1 RS485 4W 9P D-Sub Female			RS485 4W 9P D-Sub Male
1 RX-			TX-
2 RX+			TX+
3 TX-			RX-
4 TX+			RX+
5 GND			GND
			



The following represents the view of HMI & PLC.

Trio : RS485 2W



eMT3000 series

COM1 RS485 2W 9P D-Sub Male	COM3 RS485 2W 9P D-Sub Male		RS485 2W 9P D-Sub Male
1 RX-	6 Data-		D-
2 RX+	9 Data+		D+
5 GND	5 GND		GND
			

MT6000/8000 series except MT6050i/MT8050i

COM1 RS485 2W 9P D-Sub Male	COM3 RS485 2W 9P D-Sub Male		RS485 2W 9P D-Sub Male
1 RX-	6 Data-		D-
2 RX+	9 Data+		D+
5 GND	5 GND		GND
			

MT6050i/MT8050i

COM1 RS485 2W 9P D-Sub Female	COM3 RS485 2W 9P D-Sub Female		RS485 2W 9P D-Sub Male
1 RX-	7 Data-		D-
2 RX+	8 Data+		D+
5 GND	5 GND		GND
			

Direct connect (crossover cable):

HMI RJ45 Male	Wire Color	PLC RJ45 Male
1 TX+	White/Orange	3 RX+
2 TX-	Orange	6 RX-
3 RX+	White/Green	1 TX+
4 BD4+	Blue	4 BD4+
5 BD4-	White/Blue	5 BD4-
6 RX-	Green	2 TX-
7 BD3+	White/Brown	7 BD3+
8 BD3-	Brown	8 BD3-

Through a hub:

HMI RJ45 Male	Wire Color	PLC RJ45 Male
1 TX+	White/Orange	1 TX+
2 TX-	Orange	2 TX-
3 RX+	White/Green	3 RX+
4 BD4+	Blue	4 BD4+
5 BD4-	White/Blue	5 BD4-
6 RX-	Green	6 RX-
7 BD3+	White/Brown	7 BD3+
8 BD3-	Brown	8 BD3-

Driver Version:

Version	Date	Description
V1.00	Apr/20/2012	Driver released.

VIGOR

Supported Series: VIGOR M Series and VB Series.

Website: <http://www.vigorplc.com.tw/>

HMI Setting:

Parameters	Recommended	Options	Notes
PLC type	VIGOR		
PLC I/F	RS232	RS232, RS485 4W	
Baud rate	19200		
Data bits	7		
Parity	Even		
Stop bits	1		
PLC sta. no.	1		

Device Address:



Bit/Word	Device type	Format	Range	Memo
B	X	OOO	0 ~ 377	
B	Y	OOO	0 ~ 377	
B	M	DDDD	0 ~ 7999	
B	T	DDD	0 ~ 255	
B	C	DDD	0 ~ 255	
B	SM	DDDD	9000 ~ 9255	
W	TV	DDD	0 ~ 255	
W	CV	DDD	0 ~ 199	
W	D	DDDD	0 ~ 9255	
W	CV2	DDD	200 ~ 255	
W	SD	DDDD	9000 ~ 9255	

Wiring Diagram:



The following represents the view of HMI & PLC.

Vigor M series : RS485 4W Terminal



eMT3000 series

COM1 RS485 4W 9P D-Sub Male			Vigor M series RS485 4W 6P Terminal
1 RX-			TX-
2 RX+			TX+
3 TX-			RX-
4 TX+			RX+
5 GND			SG
			

MT6000/8000 series except MT6050i/MT8050i

COM1 RS485 4W 9P D-Sub Male			Vigor M series RS485 4W 6P Terminal
1 RX-			TX-
2 RX+			TX+
3 TX-			RX-
4 TX+			RX+
5 GND			SG
			



MT6050i/MT8050i

COM1 RS485 4W 9P D-Sub Female			Vigor M series RS485 4W 6P Terminal
1 RX-			TX-
2 RX+			TX+
3 TX-			RX-
4 TX+			RX+
5 GND			SG
			





The following represents the view of HMI & PLC.

Vigor M series : RS232



eMT3000 series

COM1 RS232 9P D-Sub Female	COM3 RS232 9P D-Sub Female		Vigor M series RS232 9P D-Sub Male
2 RX	8 RX		3 TXD
3 TX	7 TX		2 RXD
5 GND	5 GND	—	5 GND
			

MT6000/8000 series except MT6050i/MT8050i

COM1 RS232 9P D-Sub Female	COM2 RS232 9P D-Sub Female	COM3 RS232 9P D-Sub Male	Vigor M series RS232 9P D-Sub Male
2 RX	6 RX	8 RX	3 TXD
3 TX	4 TX	7 TX	2 RXD
5 GND	5 GND	5 GND	5 GND
			

MT6050i/MT8050i

COM1 RS232 9P D-Sub Female			Vigor M series RS232 9P D-Sub Male
9 RX			3 TXD
6 TX			2 RXD
5 GND			5 GND
			

Driver Version:

Version	Date	Description
V1.10	Dec/30/2008	

VIPA 200

HMI Setting:

Parameters	Recommended	Options	Notes
PLC type	VIPA 200		
PLC I/F	RS485 2w	RS485 2w	
Baud rate	9600	9600, 19200, 187.5K	The HMI which has a sticker "MPI187.5" on the rear cover supports 187.5K
Data bits	8	7,8	
Parity	Even	Even, Odd, None	
Stop bits	1	1, 2	
PLC sta. no.	2	1 ~ 126	
Turn around delay (ms)	5		
Reserved 1	30		ACK delay time

Online simulator	YES	Extend address mode	NO
Broadcast command	NO		

PLC Setting:

Communication mode	Set station number to 2
--------------------	-------------------------

Device Address:

Bit/Word	Device type	Format	Range	Memo
B	I	DDDDo	0 ~ 40957	Input (I)
B	Q	DDDDo	0 ~ 40957	Output (O)
B	M	DDDDo	0 ~ 40957	Bit Memory
B	VW_Bit	DDDDDo	0 ~ 102397	V Memory Bit Address
Byte	VB	DDDDD	0 ~ 10239	
W	VW	DDDDD	0 ~ 10239	V Memory
W	VW_Odd	DDDDD	0 ~ 10239	V Memory
DW	VD	DDDDD	0 ~ 10239	V Memory Double Word
DW	VD_Odd	DDDDD	0 ~ 10239	V Memory Double Word



Bit/Word	Device type	Format	Range	Memo
W	VW_String	DDDDD	0 ~ 10239	String
W	VW_String_Odd	DDDDD	0 ~ 10239	String
DW	VD_String	DDDDD	0 ~ 10239	String
DW	VD_String_Odd	DDDDD	0 ~ 10239	String
Byte	MB	DDDDD	0 ~ 10239	Byte Memory
W	MW	DDDDD	0 ~ 10239	Word Memory
DW	MD	DDDDD	0 ~ 10239	Word Memory
W	MW_Odd	DDDDD	0 ~ 10239	Word Memory
W	T	DDD	0 ~ 127	Timer
W	C	DDD	0 ~ 127	Counter

- Double word and floating point value must use VD device type.



Wiring Diagram:

The following represents the view of HMI & PLC.



eMT3000 series

COM1 RS485 2W 9P D-Sub Male	COM3 RS485 2W 9P D-Sub Male		RS485 2W 9P D-Sub Male
1 RX-	6 Data-		8 D-
2 RX+	9 Data+		3 D+
5 GND	5 GND		5 GND
			

MT6000/8000 series except MT6050i/MT8050i

COM1 RS485 2W 9P D-Sub Male	COM3 RS485 2W 9P D-Sub Male		RS485 2W 9P D-Sub Male
1 RX-	6 Data-		8 D-
2 RX+	9 Data+		3 D+
5 GND	5 GND		5 GND
			

MT6050i/MT8050i

COM1 RS485 2W 9P D-Sub Female	COM3 RS485 2W 9P D-Sub Female		RS485 2W 9P D-Sub Male
1 RX-	7 Data-		8 D-
2 RX+	8 Data+		3 D+
5 GND	5 GND		5 GND
			

Driver Version:

Version	Date	Description
V2.30	Aug/17/2009	
V2.40	Nov/1/2011	Add device type : MD

VIPA 200 (VD any address)

HMI Setting:

Parameters	Recommended	Options	Notes
PLC type	VIPA 200 (VD any address)		
PLC I/F	RS485 2w	RS485 2w	
Baud rate	9600	9600, 19200, 187.5K	The HMI which has a sticker "MPI187.5" on the rear cover supports 187.5K
Data bits	8	7,8	
Parity	Even	Even, Odd, None	
Stop bits	1	1, 2	
PLC sta. no.	2	1 ~ 126	
Turn around delay	5		
Reserved 1	30		ACK delay time

Online simulator	YES	Extend address mode	NO
Broadcast command	NO		

PLC Setting:

Communication mode	Set station number to 2
--------------------	-------------------------

Device Address:

Bit/Word	Device type	Format	Range	Memo
B	I	DDDDo	0 ~ 40957	Input (I)
B	Q	DDDDo	0 ~ 40957	Output (O)
B	M	DDDDo	0 ~ 40957	Bit Memory
B	VW_Bit	DDDDDo	0 ~ 102397	V Memory Bit Address
W	VW	DDDDD	0 ~ 10239	V Memory
DW	VD	DDDDD	0 ~ 10239	V Memory Double Word
W	VW_String	DDDDD	0 ~ 10239	String
DW	VD_String	DDDDD	0 ~ 10239	String



Bit/Word	Device type	Format	Range	Memo
W	MW	DDDDD	0 ~ 10239	Word Memory
W	T	DDD	0 ~ 127	Timer
W	C	DDD	0 ~ 127	Counter
DW	MD	DDDDD	0 ~ 10239	Word Memory

- Double word and floating point value must use VD device type.
- VD register can set to any value, not necessarily a multiple of 4.



Wiring Diagram:

The following represents the view of HMI & PLC.



eMT3000 series

COM1 RS485 2W 9P D-Sub Male	COM3 RS485 2W 9P D-Sub Male		RS485 2W 9P D-Sub Male
1 RX-	6 Data-		8 D-
2 RX+	9 Data+		3 D+
5 GND	5 GND		5 GND
			

MT6000/8000 series except MT6050i/MT8050i

COM1 RS485 2W 9P D-Sub Male	COM3 RS485 2W 9P D-Sub Male		RS485 2W 9P D-Sub Male
1 RX-	6 Data-		8 D-
2 RX+	9 Data+		3 D+
5 GND	5 GND		5 GND
			

MT6050i/MT8050i

COM1 RS485 2W 9P D-Sub Female	COM3 RS485 2W 9P D-Sub Female		RS485 2W 9P D-Sub Male
1 RX-	7 Data-		8 D-
2 RX+	8 Data+		3 D+
5 GND	5 GND		5 GND
			

Driver Version:

Version	Date	Description
V1.20	Nov/16/2011	Add device type : MD

VIPA 200, for ex. 214-2BT10 (Ethernet)

HMI Setting:

Parameters	Recommended	Options	Notes
PLC type	VIPA 200, for ex. 214-2BT10 (Ethernet)		
PLC I/F	Ethernet		
Port no.	102		
PLC sta. no.	1	0-31	

Device Address:

Bit/Word	Device type	Format	Range	Memo
B	I	DDDDo	0 ~ 40957	Input (I)
B	Q	DDDDo	0 ~ 40957	Output (O)
B	M	DDDDo	0 ~ 40957	Bit Memory
B	VW_Bit	DDDDDo	0 ~ 102397	V Memory Bit Address
W	VW	DDDDD	0 ~ 10239	V Memory
DW	VD	DDDDD	0 ~ 10239	V Memory Double Word
W	VW_String	DDDDD	0 ~ 10239	String
DW	VD_String	DDDDD	0 ~ 10239	String
DW	MD	DDDDD	0 ~ 10239	Word Memory

- Double word and floating point value must use VD device type.

Wiring Diagram:

Direct connect (crossover cable):

HMI RJ45 Male	Wire Color	PLC RJ45 Male
1 TX+	White/Orange	3 RX+
2 TX-	Orange	6 RX-
3 RX+	White/Green	1 TX+
4 BD4+	Blue	4 BD4+
5 BD4-	White/Blue	5 BD4-
6 RX-	Green	2 TX-
7 BD3+	White/Brown	7 BD3+
8 BD3-	Brown	8 BD3-



Through a hub:

HMI RJ45 Male	Wire Color	PLC RJ45 Male
1 TX+	White/Orange	1 TX+
2 TX-	Orange	2 TX-
3 RX+	White/Green	3 RX+
4 BD4+	Blue	4 BD4+
5 BD4-	White/Blue	5 BD4-
6 RX-	Green	6 RX-
7 BD3+	White/Brown	7 BD3+
8 BD3-	Brown	8 BD3-



Driver Version:

Version	Date	Description
V1.20	Dec/30/2008	
V1.40	Nov/15/2011	Add device type : MD

VIPA 300

HMI Setting:

Parameters	Recommended	Options	Notes
PLC type	VIPA 300		
PLC I/F	RS232		
Baud rate	19200, 38400, 187.5K	9600~187.5K	Must be same as the PLC setting. The HMI which has a sticker MPI187.5 on the rear cover supports 187.5K.
Data bits	8		
Parity	Odd		
Stop bits	1		
PLC sta. no.	2		Must be same as the PLC setting.

Device Address:

Bit/Word	Device type	Format	Range	Memo
B	I	DDDDo	0 ~ 40957	Input (I)
B	Q	DDDDo	0 ~ 40957	Output (O)
B	M	DDDDo	0 ~ 40957	Bit Memory
B	DBnBit	FFFFDDDDo	0 ~ 409681927	Data Register Bit
B	DB0Bit ~	DDDDo	0 ~ 81927	
W	IW	DDDD	0 ~ 4095	Input (I)
W	QW	DDDD	0 ~ 4095	Output (O)
W	MW	DDDD	0 ~ 4095	Bit Memory
DW	MD	DDDD	0 ~ 4094	
Byte	MB	DDDD	0 ~ 4095	Bit Memory Byte
Byte	DBBn	FFFFDDDD	0 ~ 40968192	Data Register Byte
W	DBn	FFFFDDDD	0 ~ 40968192	Data Register (must be even)
DW	DBDn	FFFFDDDD	0 ~ 40968192	Data Register Double Word (must be multiple of 4)
W	DBn_String	FFFFDDDD	0 ~ 40968192	Data Register Double Word (must be multiple of 4)

Bit/Word	Device type	Format	Range	Memo
DW	DBDn_String	FFFFDDDD	0 ~ 40968192	Data Register Double Word (must be multiple of 4)
W	DB0-DB99	DDDD	0 ~ 8192	Data Register (must be even)

* Double word and floating point value must use DBDn device type.

How to Import Tag:

SIEMENS STEP 7 program allows building files of user-defined tag (*.dif file and *.AWL file), and import these files in EasyBuilder8000/EasyBuilderPro -> System Parameter Settings. The following describes how to build and import these two types of files.

1. Building *.dif File

- a. In "Symbols" create user-defined tag.

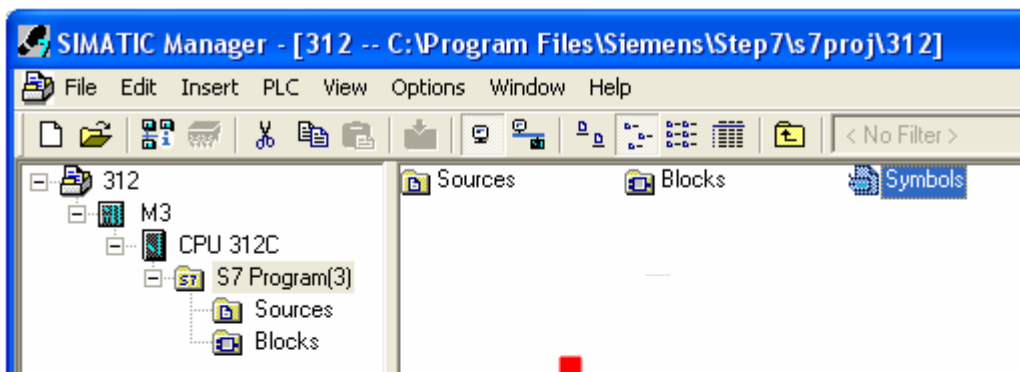

	Status	Symbol	Address	Data type	Comment
1		I0.0	I 0.0	BOOL	
2		I0.1	I 0.1	BOOL	
3		I0.2	I 0.2	BOOL	
4		I0.3	I 0.3	BOOL	
5		I0.4	I 0.4	BOOL	
6		I0.5	I 0.5	BOOL	
7		I0.6	I 0.6	BOOL	
8		I0.7	I 0.7	BOOL	

b. Click **Export** to export the edited file and click **Save**.

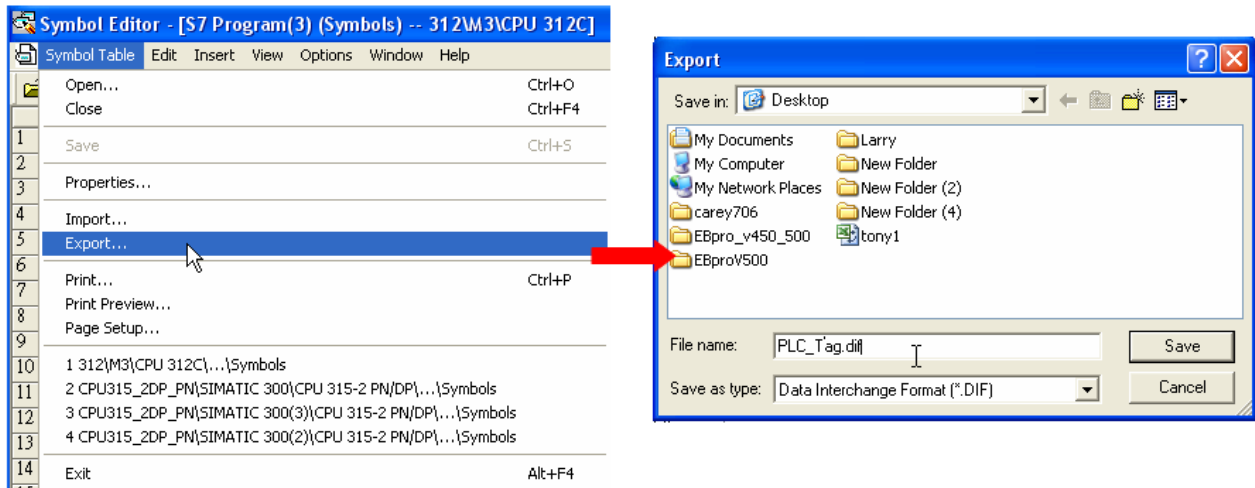

2. Building *.AWF File

a. In **Blocks** create items as shown below:

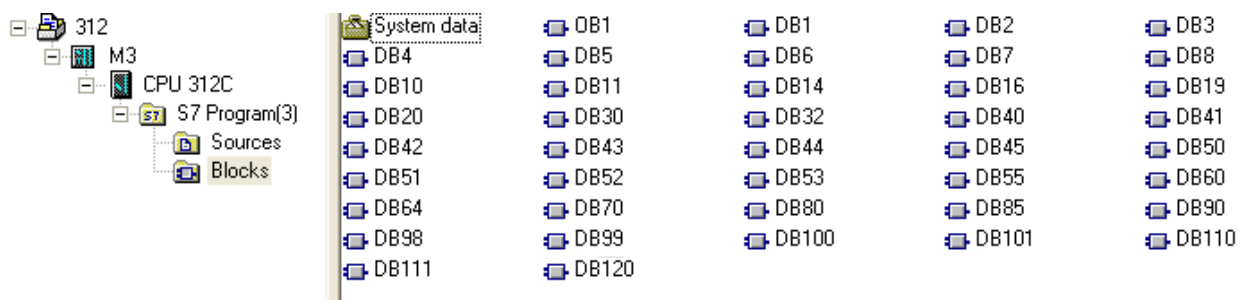

b. Open LAD/STL, FBD – Programming S7 Blocks, click **File -> Generate Source**.

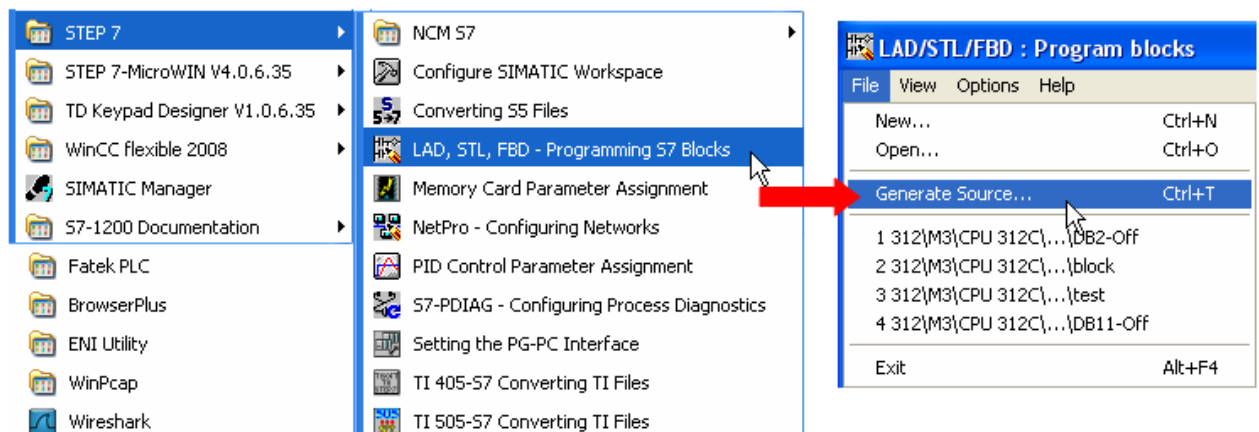

- c ․ Select **Sources** as storage path, specify the file name then click **OK**.

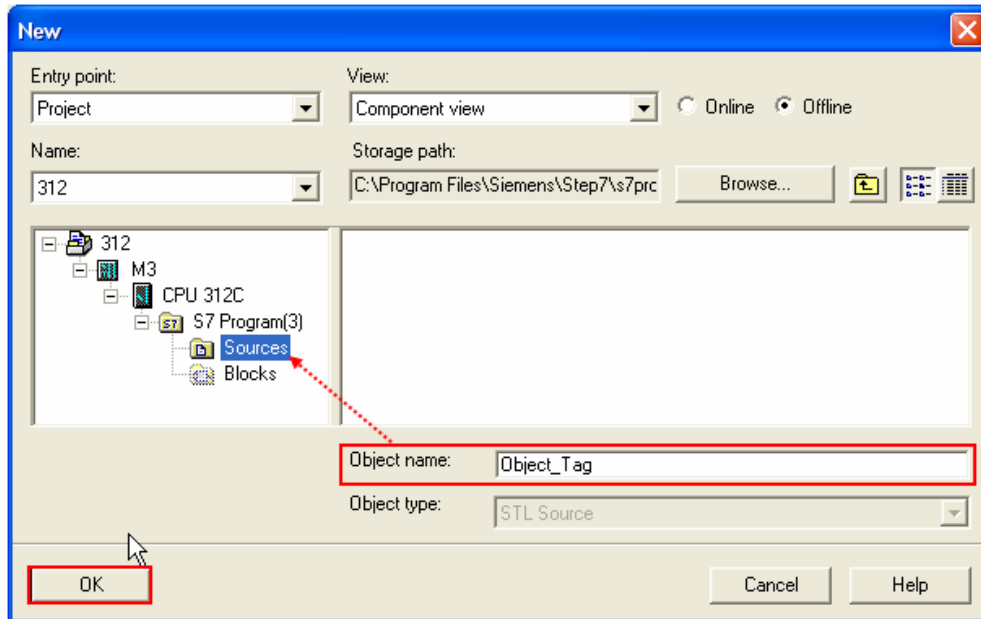

- d ․ Select the objects to be exported then click **OK**.

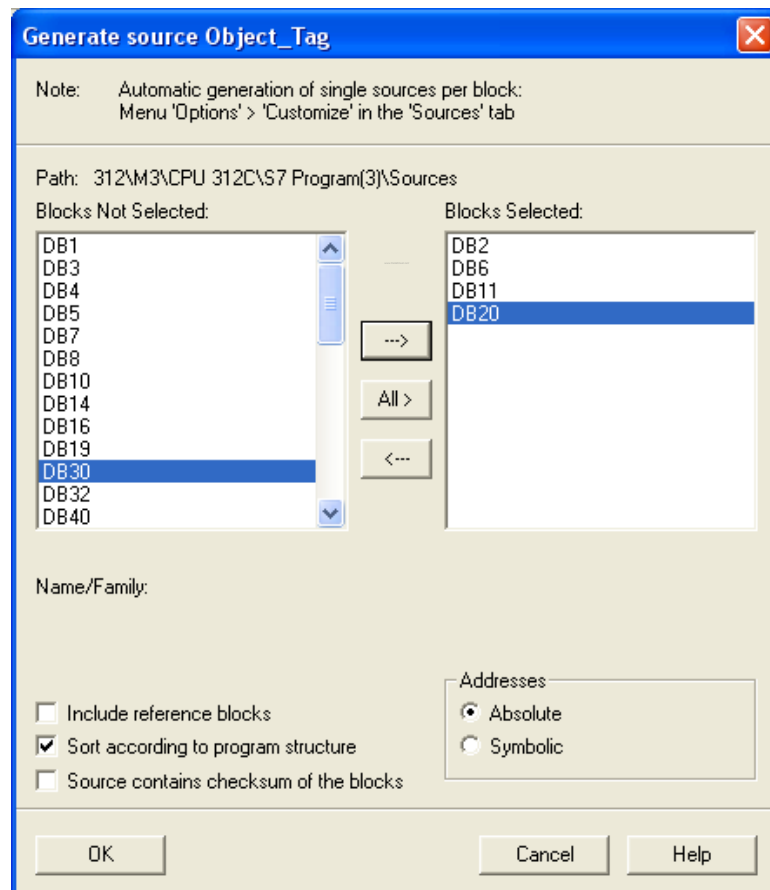

- e、 Under **Sources** there will be names of the saved files, select **Export Source** to build *.AWL file.

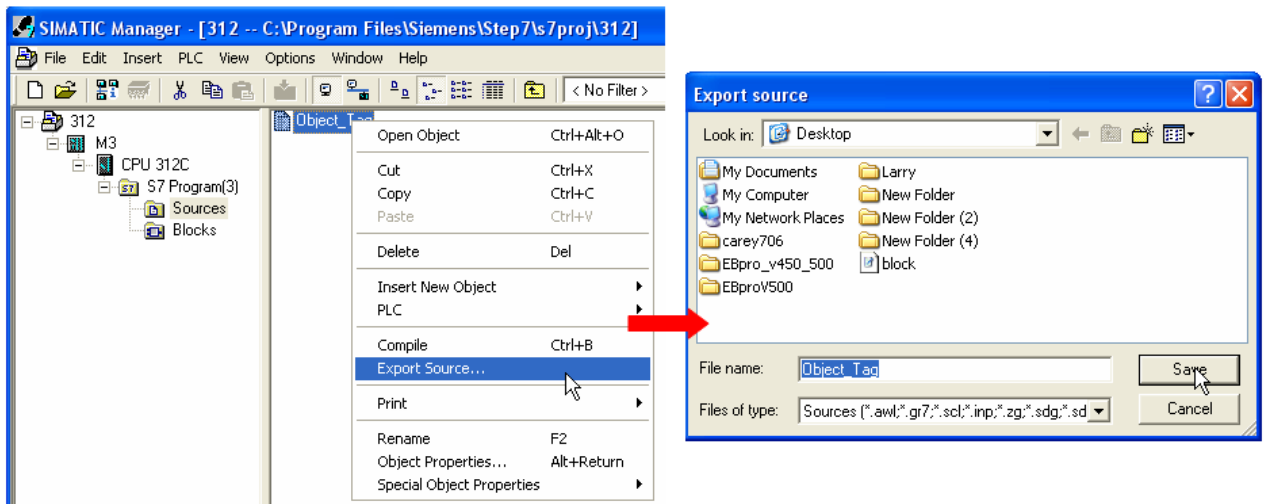

The generated *.dif and *.AWL files can be imported in EasyBuilder8000/EasyBuilderPro **System Parameter Settings**, by clicking **Import Tag**.

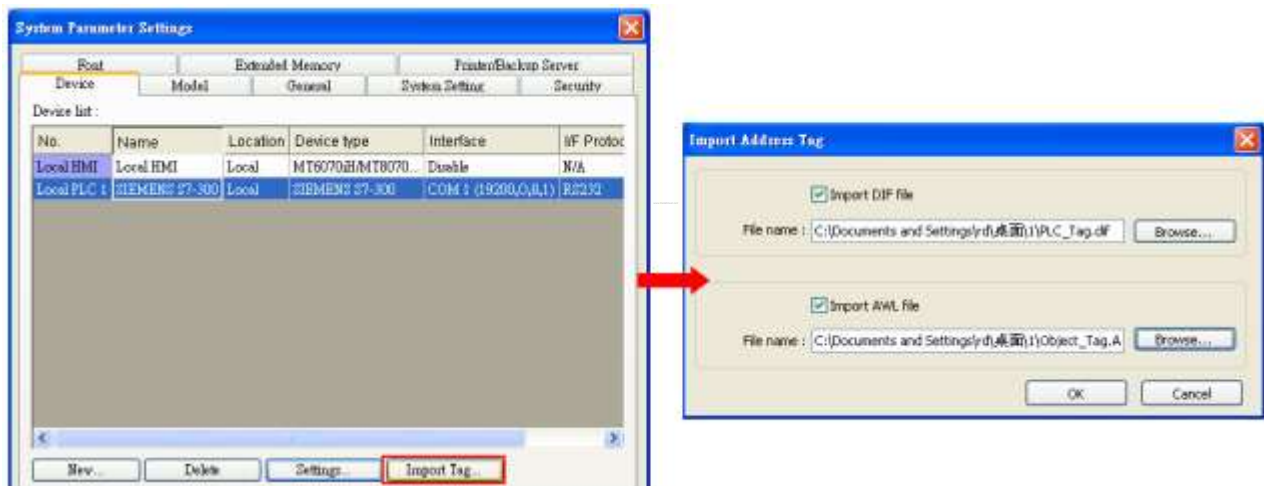

Tag information successfully imported.





Wiring Diagram:





The following represents the view of HMI & PLC.

Siemens S7-300 PC Adapter : 9P D-Sub to 9P D-Sub:



eMT3000 series

COM1 RS232 9P D-Sub Female	COM3 RS232 9P D-Sub Female		RS232 9P D-Sub Male
2 RX	8 RX		3 TXD
3 TX	7 TX		2 RXD
5 GND	5 GND		5 GND
			7 RTS
			8 CTS
			circuit
			

MT6000/8000 series except MT6050i/MT8050i

COM1 RS232 9P D-Sub Female	COM2 RS232 9P D-Sub Female	COM3 RS232 9P D-Sub Male	RS232 9P D-Sub Male
2 RX	6 RX	8 RX	3 TXD
3 TX	4 TX	7 TX	2 RXD
5 GND	5 GND	5 GND	5 GND
			7 RTS
			8 CTS
			circuit
			



MT6050i/MT8050i

COM1 RS232 9P D-Sub Female			RS232 9P D-Sub Male
9 RX			3 TXD
6 TX			2 RXD
5 GND			5 GND
			7 RTS
			8 CTS
			circuit
			





The following represents the view of HMI & PLC.

Systeme Helmholz SSW7-TS : 9P D-Sub to 9P D-Sub



eMT3000 series

COM1 RS232 9P D-Sub Female	COM3 RS232 9P D-Sub Female		RS232 9P D-Sub Male
2 RX	8 RX		3 TXD
3 TX	7 TX		2 RXD
5 GND	5 GND		5 GND
			7 RTS
			8 CTS
			4 DTR
			6 DSR
			circuit
			circuit
			

MT6000/8000 series except MT6050i/MT8050i

COM1 RS232 9P D-Sub Female	COM2 RS232 9P D-Sub Female	COM3 RS232 9P D-Sub Male	RS232 9P D-Sub Male
2 RX	6 RX	8 RX	3 TXD
3 TX	4 TX	7 TX	2 RXD
5 GND	5 GND	5 GND	5 GND
			7 RTS
			8 CTS
			4 DTR
			6 DSR
			circuit
			circuit
			

MT6050i/MT8050i

COM1 RS232 9P D-Sub Female			RS232 9P D-Sub Male
9 RX			3 TXD
6 TX			2 RXD
5 GND			5 GND
			7 RTS
			8 CTS
			4 DTR
			6 DSR
			circuit
			circuit
			

Driver Version:

Version	Date	Description
V3.10	May/24/2011	Added registers: MB & DBBn.

VIPA 300 MPI

HMI Setting:

Parameters	Recommended	Options	Notes
PLC type	VIPA 300 MPI		
PLC I/F	RS-485 2W		
Baud rate	187.5K		Only HMI with a sticker "MPI 187.5K" on the rear cover supports MPI communication.
Data bits	8		
Parity	Even		
Stop bits	1		
PLC sta. no.	2	2 ~ 31	

Online simulator	NO	Extend address mode	Yes
Broadcast command	NO		

Device Address:

Bit/Word	Device type	Format	Range	Memo
B	I	DDDDo	0 ~ 40957	Input (I)
B	Q	DDDDo	0 ~ 40957	Output (O)
B	M	DDDDo	0 ~ 40957	Bit Memory
B	DBnBit	FFFFDDDDo	0 ~ 409699997	Data Register Bit
B	DB0Bit ~ DB99Bit	DDDDDo	0 ~ 655327	Data Register Bit
W	IW	DDDD	0 ~ 4095	Input (I)
W	QW	DDDD	0 ~ 4095	Output (O)
W	MW	DDDD	0 ~ 4095	Bit Memory
DW	MD	DDDD	0 ~ 4094	
Byte	MB	DDDD	0 ~ 4095	Bit Memory Byte
Byte	DBBn	FFFFDDDD	0 ~ 40969999	Data Register
W	DBn	FFFFDDDD	0 ~ 40969999	Data Register (must be even)
DW	DBDn	FFFFDDDD	0 ~ 40969999	Data Register Double Word
W	DBn_String	FFFFDDDD	0 ~ 40969999	
DW	DBDn_String	FFFFDDDD	0 ~ 40969999	
W	DB0 ~ DB99	DDDD	0 ~ 65532	Data Register (must be even)

* Double word and floating point value must use DBDn device type.

Multi-HMIs-Multi-PLCs Communication Setting:



For SIEMENS S7-300 MPI driver in Multi-HMIs-Multi-PLCs communication, [Max. station no. (MPI network)] parameter must be correctly set. This setting is relevant to the station no. of the devices, as shown, two HMI (station no. 0, 1) and two PLC (station no. 2, 3) are in MPI network, Max. Station No. should be set to 3.

Device Properties

Name : SIEMENS S7-300 MPI

HMI PLC

Location : Local

PLC type : SIEMENS S7-300 MPI
V.2.00, SIEMENS_S7_300_MPI.so

PLC I/F : RS-485 2W

COM : COM1 (187,5K,E,8,1)

PLC default station no. : 2

Default station no. use station no. variable

Max. station no. (MPI network) : 3

Interval of block pack (words) : 5

Max. read-command size (words) : 20

Max. write-command size (words) : 20

For the effectiveness of communication, users may set PLC device in STEP 7 as shown below. In Properties MPI / Network Settings, set Highest MPI address to the number closest to the actual device station number.

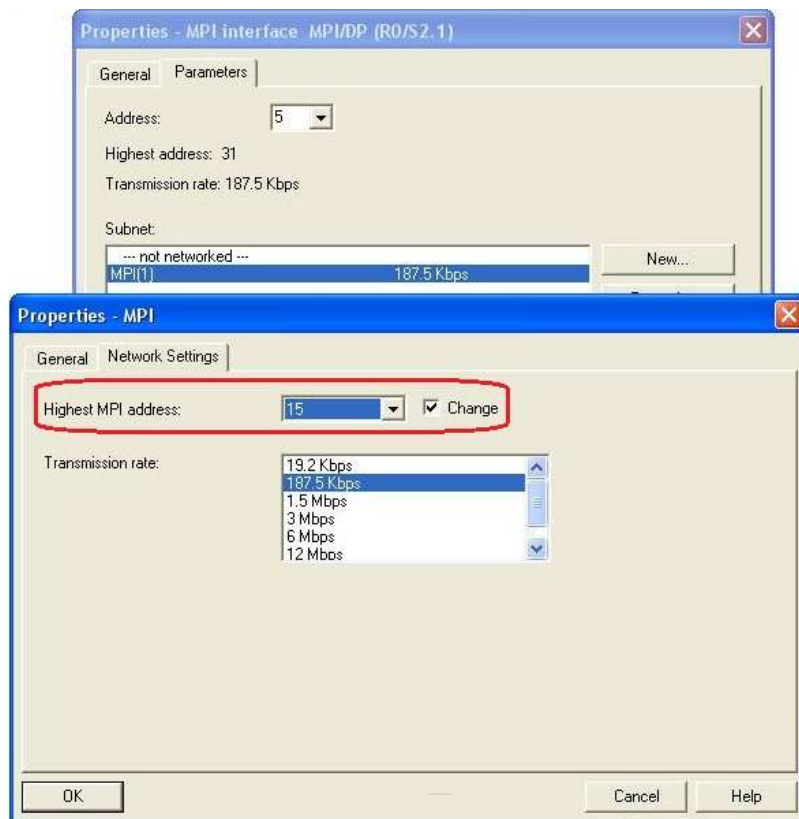

Note:

- HMI sta. no. can not be the same as PLC sta. no.
- Highly recommended that the device station numbers start from 0 sequentially and correctly set [Max. station no. (MPI network)].
- Available for EasyBuilder V4.50 and later.

How to Import Tag:

SIEMENS STEP 7 program allows building files of user-defined tag (*.dif file and *.AWL file), and import these files in EasyBuilder8000/EasyBuilderPro -> System Parameter Settings. The following describes how to build and import these two types of files.

1. Building *.dif File

- a. In "Symbols" create user-defined tag.

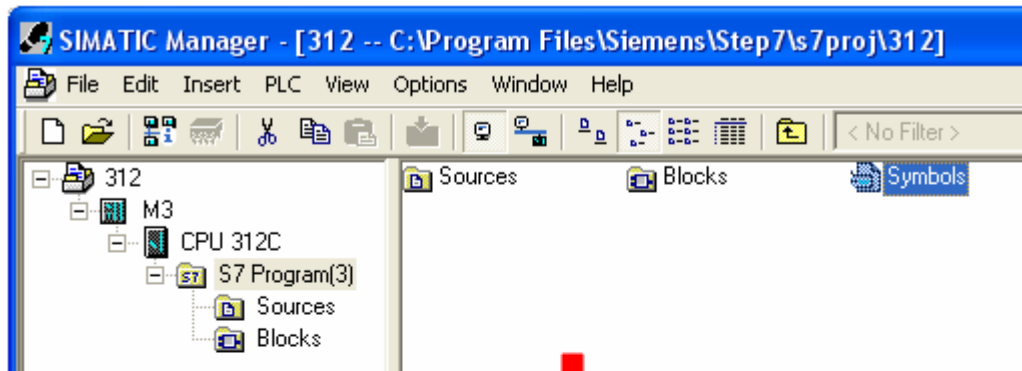
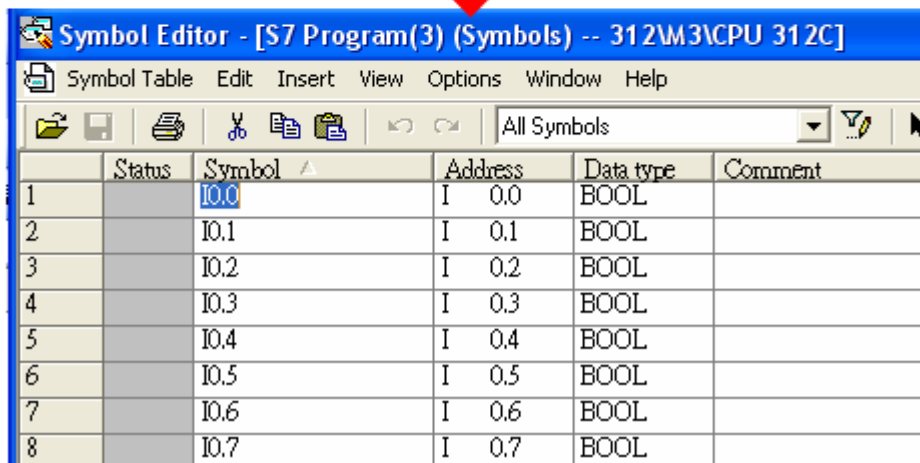
	Status	Symbol ^	Address	Data type	Comment
1		I0.0	I 0.0	BOOL	
2		I0.1	I 0.1	BOOL	
3		I0.2	I 0.2	BOOL	
4		I0.3	I 0.3	BOOL	
5		I0.4	I 0.4	BOOL	
6		I0.5	I 0.5	BOOL	
7		I0.6	I 0.6	BOOL	
8		I0.7	I 0.7	BOOL	

b. Click **Export** to export the edited file and click **Save**.

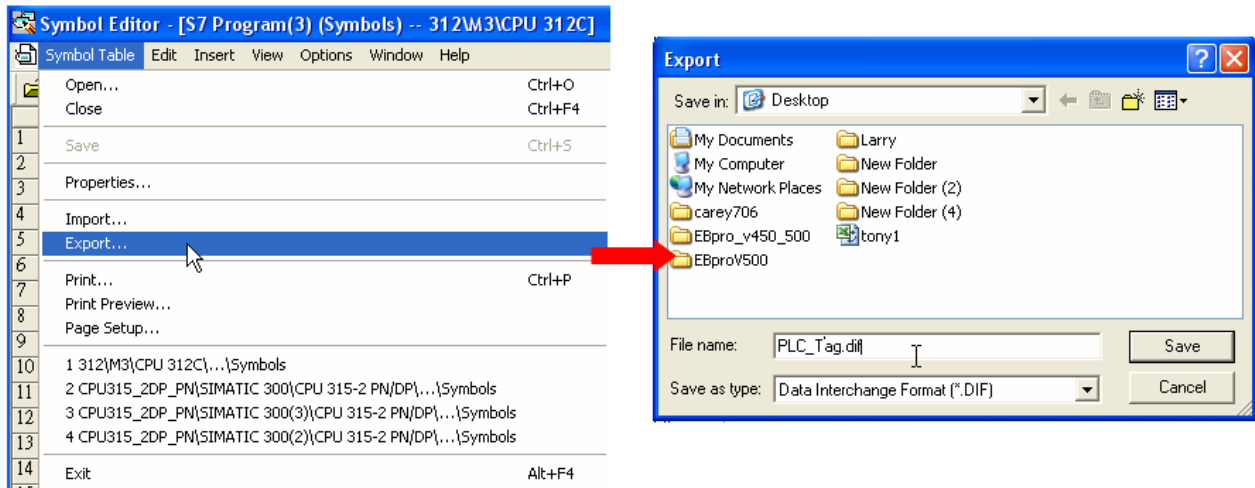

2. Building *.AWF File

a. In **Blocks** create items as shown below:

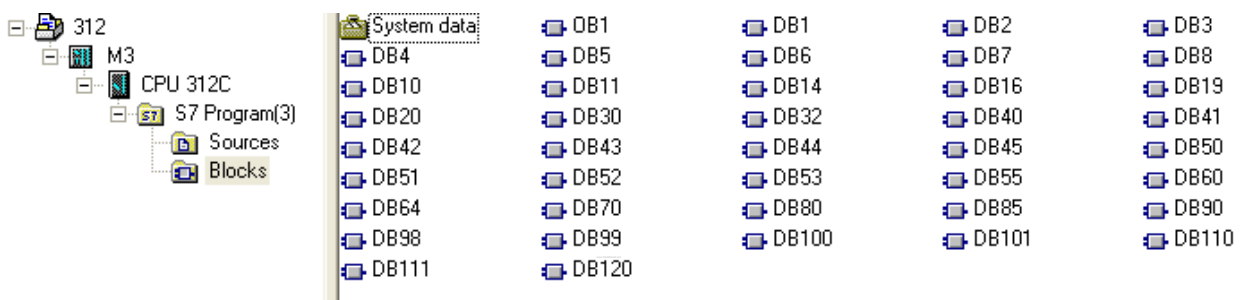

b. Open LAD/STL, FBD – Programming S7 Blocks, click **File -> Generate Source**.

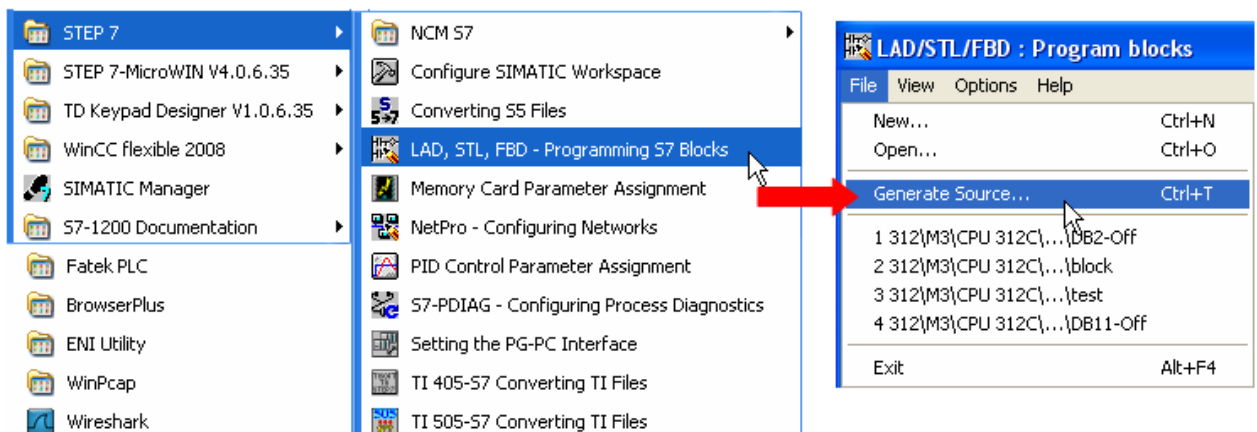

- c ․ Select **Sources** as storage path, specify the file name then click **OK**.

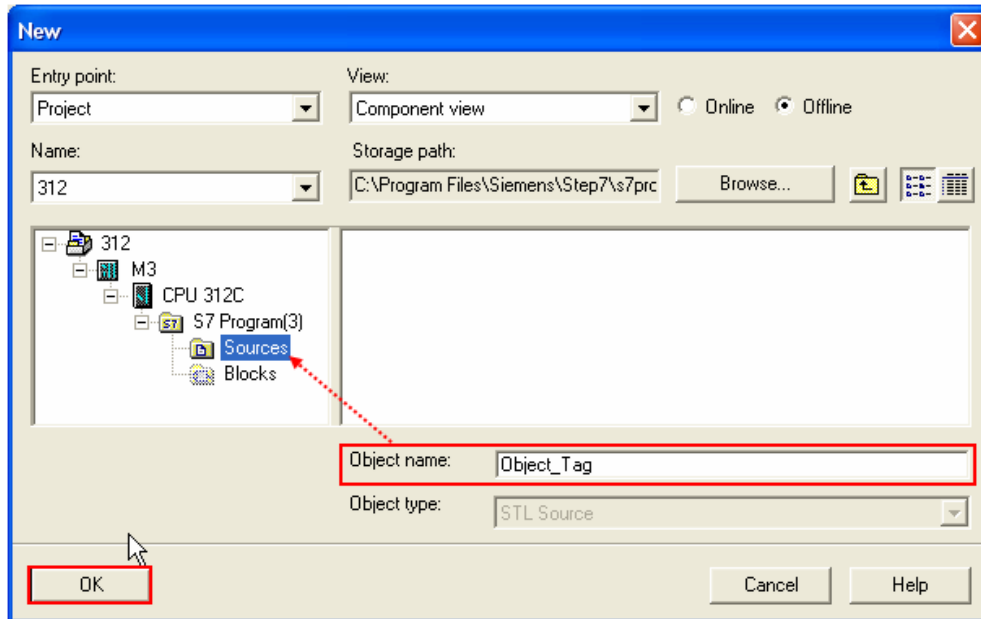

- d ․ Select the objects to be exported then click **OK**.

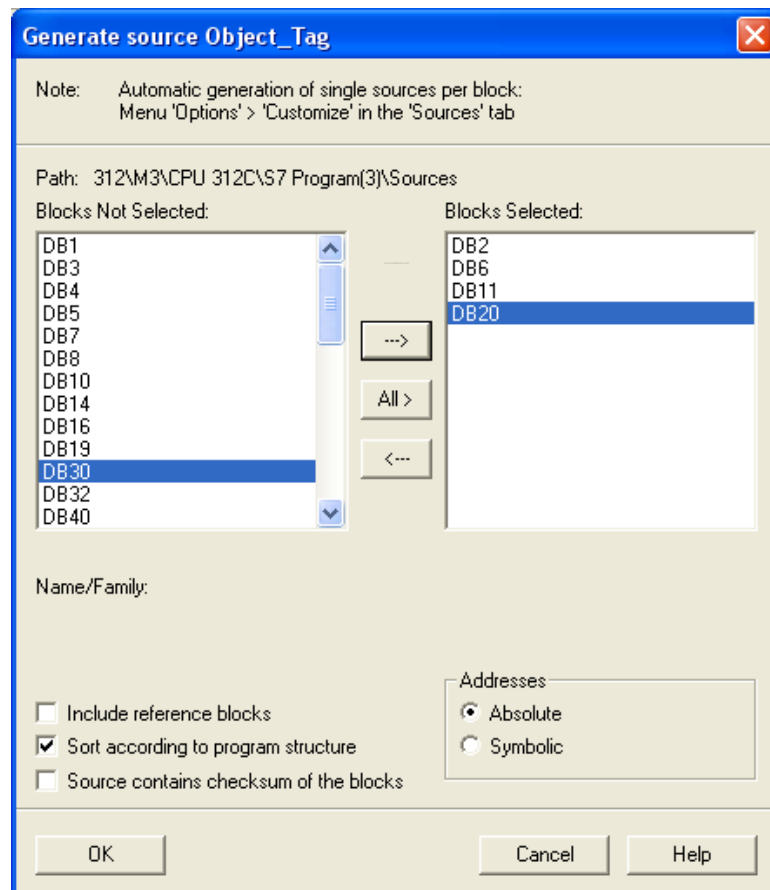

- e、 Under **Sources** there will be names of the saved files, select **Export Source** to build *.AWL file.

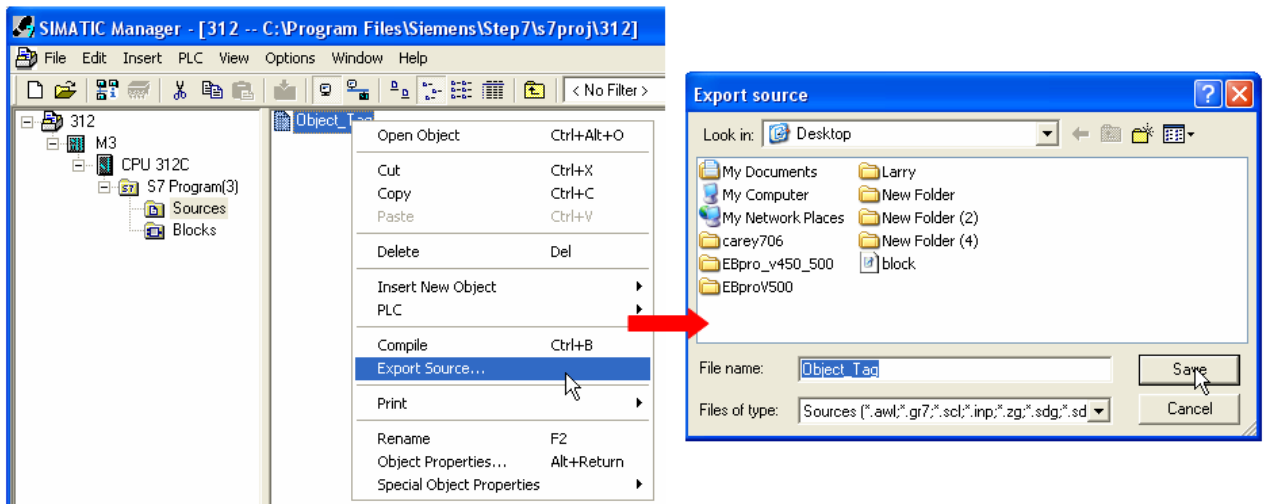

The generated *.dif and *.AWL files can be imported in EasyBuilder8000/EasyBuilderPro **System Parameter Settings**, by clicking **Import Tag**.

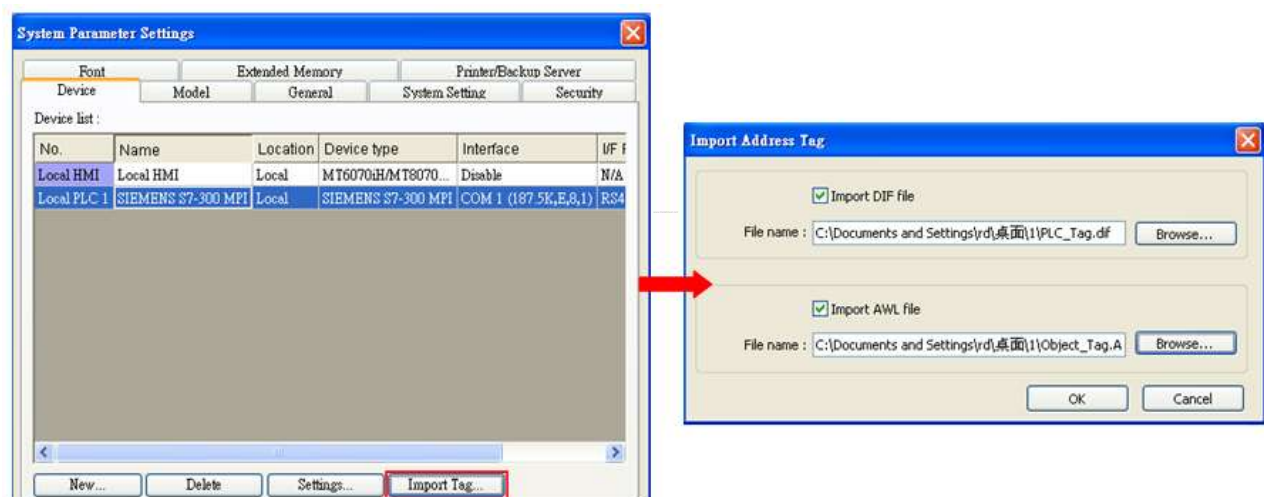

Tag information successfully imported.





Wiring Diagram:

The following represents the view of HMI & PLC.

S7-200 PPI , S7-300 MPI :RS485 2W



eMT3000 series

COM1 RS485 2W 9P D-Sub Male	COM3 RS485 2W 9P D-Sub Male		RS485 2W 9P D-Sub Male
1 RX-	6 Data-		8 D-
2 RX+	9 Data+		3 D+
5 GND	5 GND		5 GND
			

MT6000/8000 series except MT6050i/MT8050i

COM1 RS485 2W 9P D-Sub Male	COM3 RS485 2W 9P D-Sub Male		RS485 2W 9P D-Sub Male
1 RX-	6 Data-		8 D-
2 RX+	9 Data+		3 D+
5 GND	5 GND		5 GND
			

MT6050i/MT8050i

COM1 RS485 2W 9P D-Sub Female	COM3 RS485 2W 9P D-Sub Female		RS485 2W 9P D-Sub Male
1 RX-	7 Data-		8 D-
2 RX+	8 Data+		3 D+
5 GND	5 GND		5 GND
			

Driver Version:

Version	Date	Description
V1.90	May/26/2011	Added registers: MB & DBBn
V2.00	Aug/19d/2011	i Series HMI support Multi HMIs-Multi PLCs communication.

VIPA 300S (Ethernet)

HMI Setting:

Parameters	Recommended	Options	Notes
PLC type	VIPA 300S (Ethernet)		
PLC I/F	Ethernet		
Port no.	102		
Link type	PG	PC, OP	
Rack	0	0-7	
CPU slot	3	2-31	
PLC sta. no.	0	0-31	

Device Address:

Bit/Word	Device type	Format	Range	Memo
B	I	DDDDo	0 ~ 40957	Input (I)
B	Q	DDDDo	0 ~ 40957	Output (O)
B	M	DDDDo	0 ~ 40957	Bit Memory
B	DBnBit	FFFFFFDDDDo	0 ~ 655359997	
B	DB0Bit-DB99Bit	DDDDDo	0 ~ 655327	Data Register Bit
W	IW	DDDD	0 ~ 4095	Input (I)
W	QW	DDDD	0 ~ 4095	Output (O)
W	MW	DDDD	0 ~ 4095	Bit Memory
DW	MD	DDDD	0 ~ 4094	
W	DBn	FFFFFFDDDD	0 ~ 655359999	Data Register (must be even)
DW	DBDn	FFFFFFDDDD	0 ~ 655359999	Data Register Double Word
W	DBn_String	FFFFFFDDDD	0 ~ 655359999	
DW	DBDn_String	FFFFFFDDDD	0 ~ 655359999	
W	DB0 ~ DB99	DDDDD	0 ~ 65532	Data Register
Byte	MB	DDDD	0 ~ 4095	Bit Memory Byte
Byte	DBBn	FFFFFFDDDD	0 ~ 655359999	Data Register Byte

* Double word and floating point value must use DBDn device type.

Wiring Diagram:

Direct connect (crossover cable):

HMI RJ45 Male	Wire Color	PLC RJ45 Male
1 TX+	White/Orange	3 RX+
2 TX-	Orange	6 RX-
3 RX+	White/Green	1 TX+
4 BD4+	Blue	4 BD4+
5 BD4-	White/Blue	5 BD4-
6 RX-	Green	2 TX-
7 BD3+	White/Brown	7 BD3+
8 BD3-	Brown	8 BD3-



Through a hub:

HMI RJ45 Male	Wire Color	PLC RJ45 Male
1 TX+	White/Orange	1 TX+
2 TX-	Orange	2 TX-
3 RX+	White/Green	3 RX+
4 BD4+	Blue	4 BD4+
5 BD4-	White/Blue	5 BD4-
6 RX-	Green	6 RX-
7 BD3+	White/Brown	7 BD3+
8 BD3-	Brown	8 BD3-



EasyBuilder Device Setting Steps

1. Open EasyBuilder, File/NEW, select HMI model and press [OK].

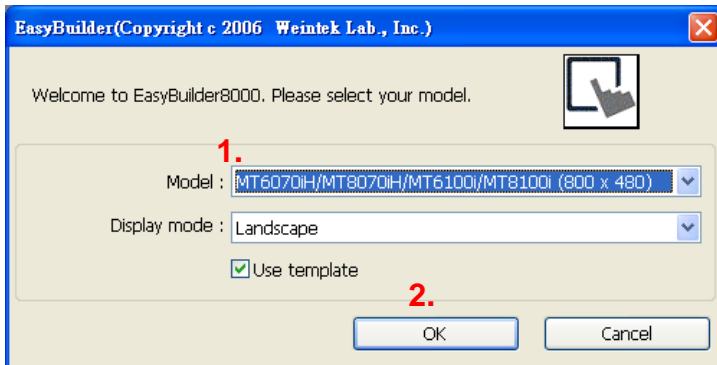

2. "System Parameter Settings" window is shown, click [New].
3. Select "SIEMENS S7-400(ETHERNET)".

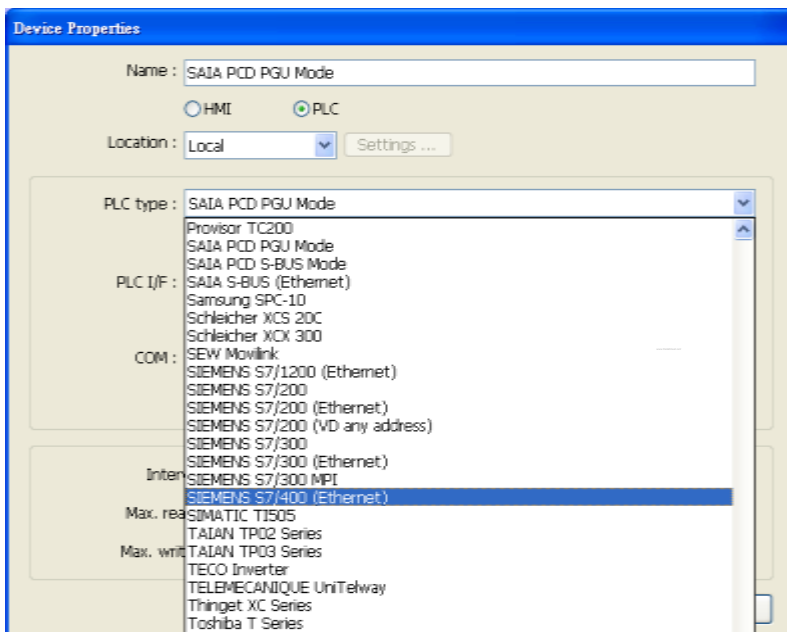

4. Press [Settings].
5. Set S7-400 IP, Port no., Link type, Rack and CPU slot. (must match PLC settings)

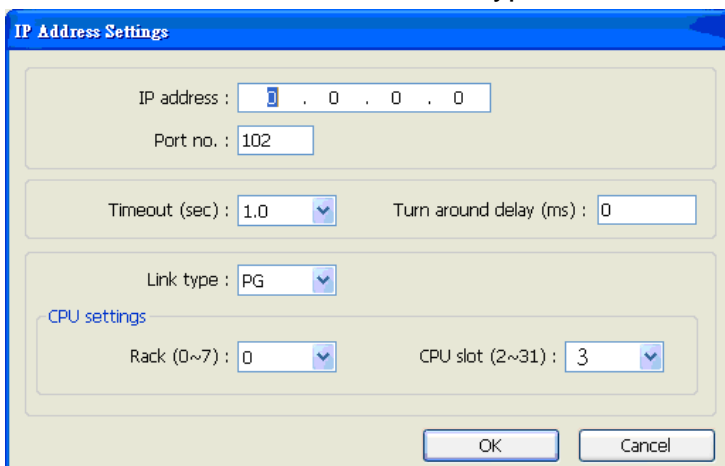

6. The setting will be finished as below.

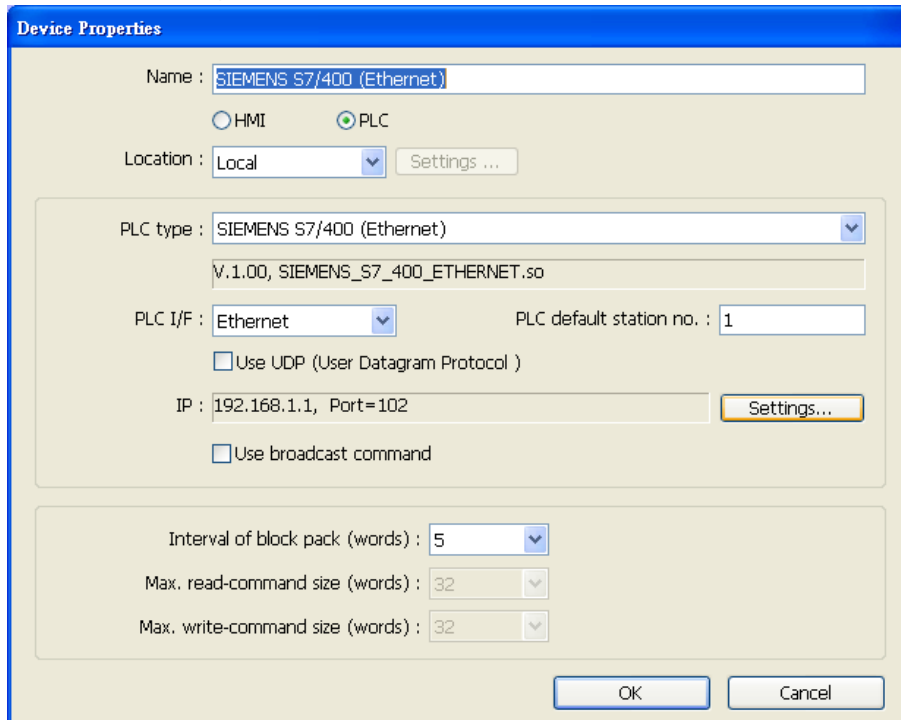

How to Import Tag:

SIEMENS STEP 7 program allows building files of user-defined tag (*.dif file and *.AWL file), and import these files in EasyBuilder8000/EasyBuilderPro -> System Parameter Settings. The following describes how to build and import these two types of files.

1. Building *.dif File

- a. In "Symbols" create user-defined tag.

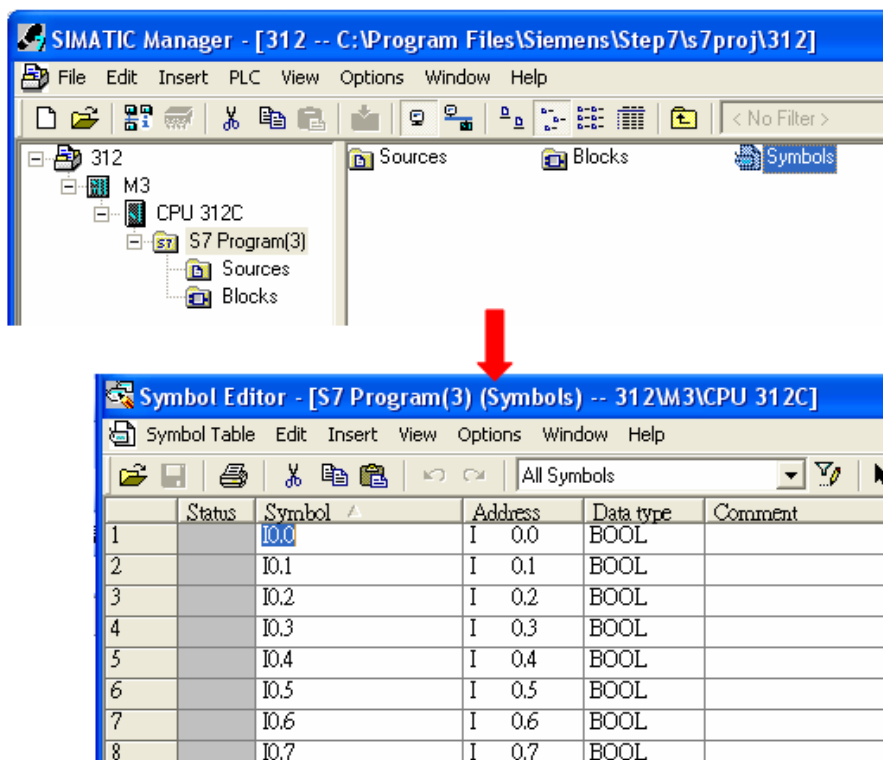

b ▸ Click **Export** to export the edited file and click **Save**.

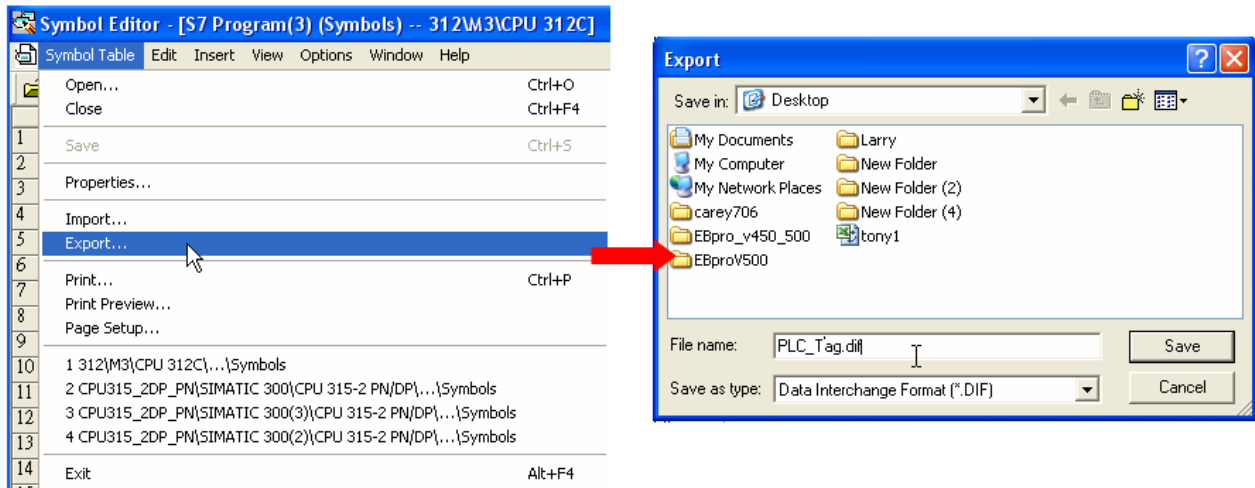

2. Building *.AWF File

a ▸ In **Blocks** create items as shown below:

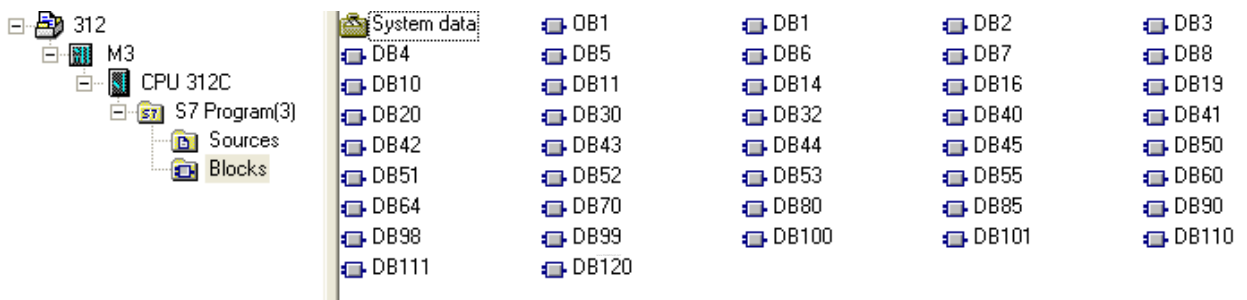

b ▸ Open LAD/STL, FBD – Programming S7 Blocks, click **File** -> **Generate Source**.

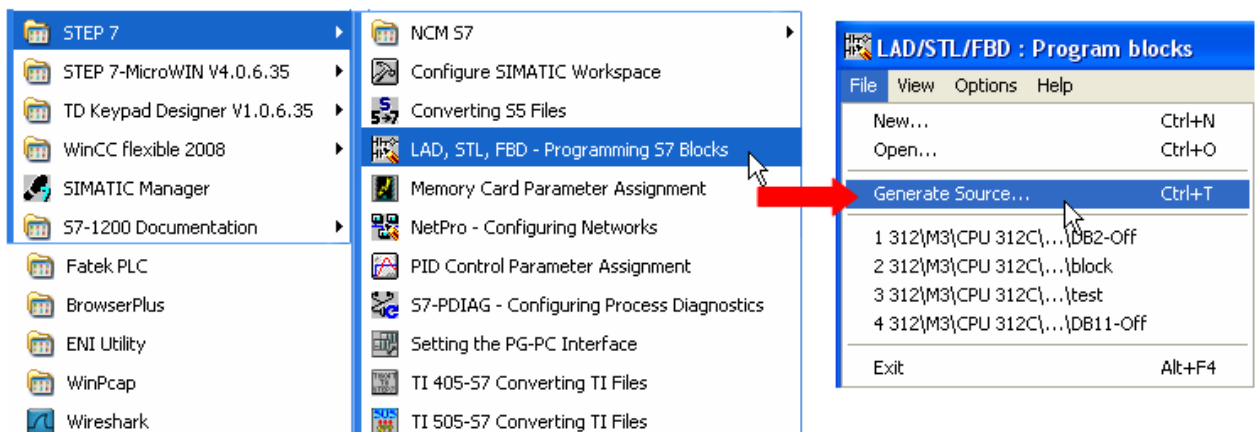

- c 、 Select **Sources** as storage path, specify the file name then click **OK**.

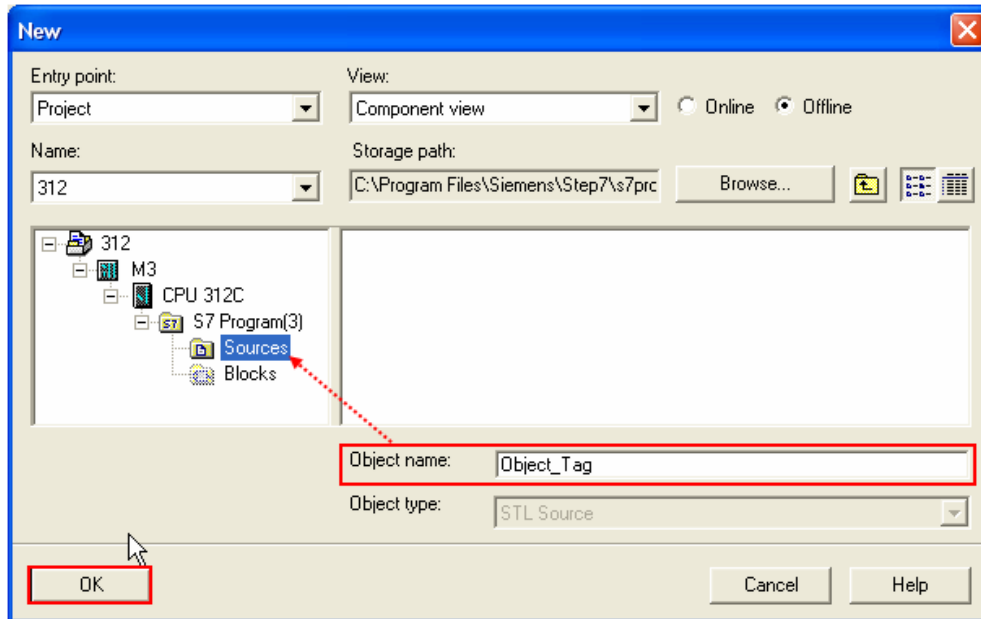

- d 、 Select the objects to be exported then click **OK**.

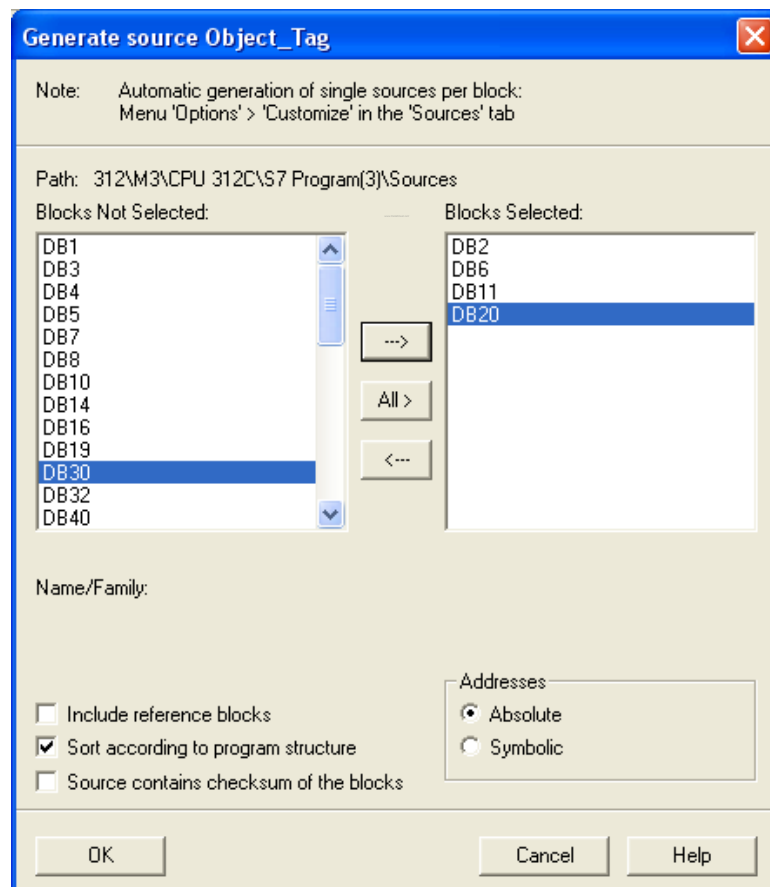

- e、 Under **Sources** there will be names of the saved files, select **Export Source** to build *.AWL file.

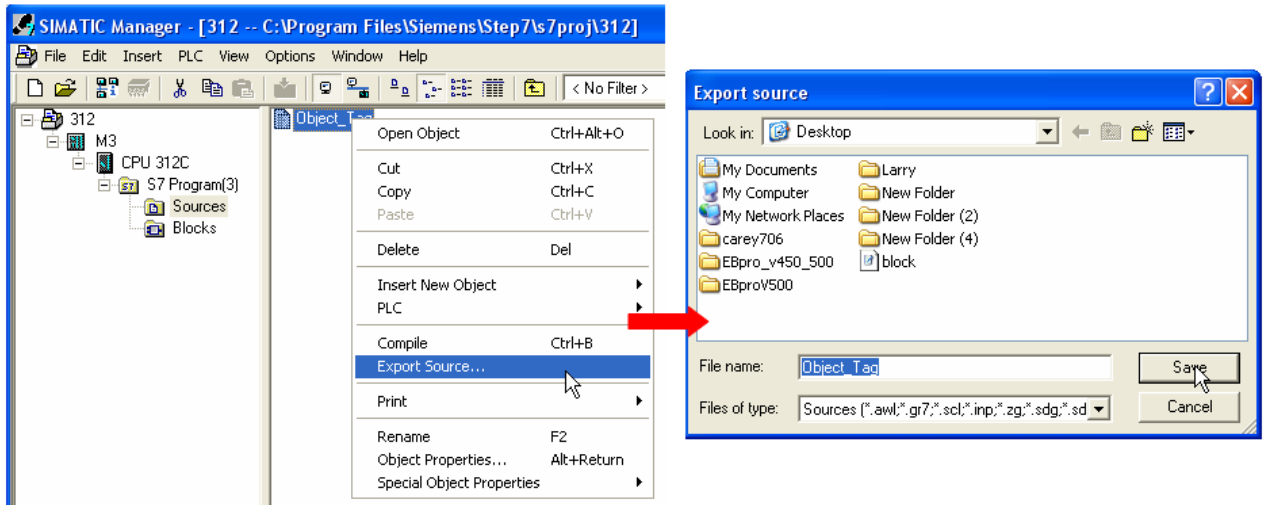

The generated *.dif and *.AWL files can be imported in EasyBuilder8000/EasyBuilderPro **System Parameter Settings**, by clicking **Import Tag**.

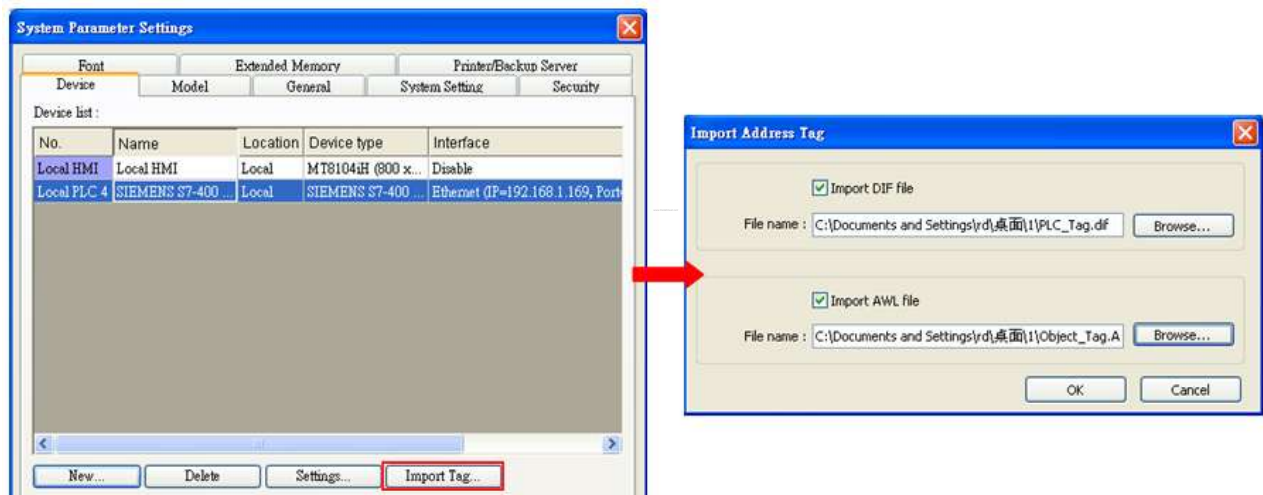

Tag information successfully imported.



Driver Version:

Version	Date	Description
V1.50	Aug/03/2012	Device types DBn, DBDn is extended to 655359999.

VIPA 300S, for ex. 315-4NE12 (Ethernet)

HMI Setting:

Parameters	Recommended	Options	Notes
PLC type	VIPA 300S, for ex. 315-4NE12 (Ethernet)		
PLC I/F	Ethernet		
Port no.	102		
PLC sta. no.	1	0-31	

Device Address:

Bit/Word	Device type	Format	Range	Memo
B	I	DDDDo	0 ~ 40957	Input (I)
B	Q	DDDDo	0 ~ 40957	Output (O)
B	M	DDDDo	0 ~ 40957	Bit Memory
B	DBnBit	FFFFDDDDo	0 ~ 40969997	
B	DB0Bit-DB99Bit	DDDDDo	0 ~ 655327	Data Register Bit
W	IW	DDDD	0 ~ 4095	Input (I)
W	QW	DDDD	0 ~ 4095	Output (O)
W	MW	DDDD	0 ~ 4095	Bit Memory
DW	MD	DDDD	0 ~ 4094	Bit Memory Double Word
W	DBn	FFFFDDDD	0 ~ 40969999	Data Register (must be even)
DW	DBDn	FFFFDDDD	0 ~ 40969999	Data Register Double Word (must be multiple of 4)
W	DBn_String	FFFFDDDD	0 ~ 40969999	
DW	DBDn_String	FFFFDDDD	0 ~ 40969999	
W	DB0 ~ DB99	DDDDD	0 ~ 65532	Data Register (must be even)
Byte	MB	DDDD	0 ~ 4095	Bit Memory Byte
Byte	DBBn	FFFFDDDD	0 ~ 40969999	Data Register Byte

- Double word and floating point value must use DBDn device type.

How to Import Tag:

SIEMENS STEP 7 program allows building files of user-defined tag (*.dif file and *.AWL file), and import these files in EasyBuilder8000/EasyBuilderPro -> System Parameter Settings. The following describes how to build and import these two types of files.

1. Building *.dif File

- a. In "Symbols" create user-defined tag.

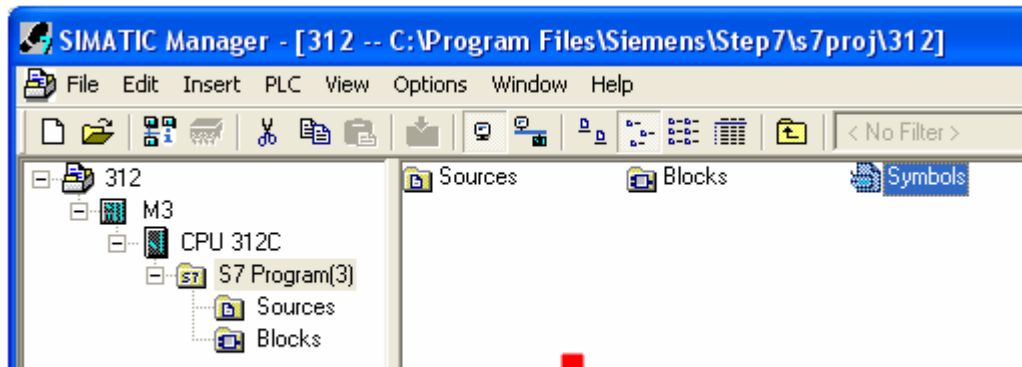
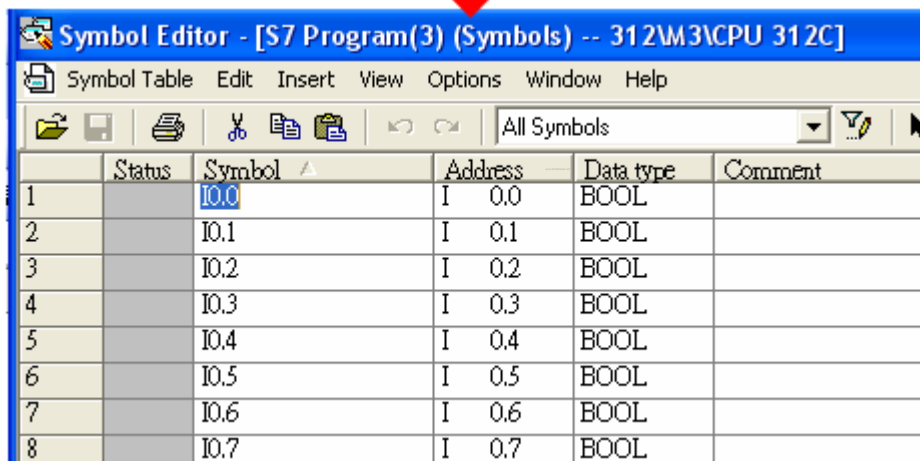
The screenshot shows the Symbol Editor window. The title bar reads "Symbol Editor - [S7 Program(3) (Symbols) -- 312\M3\CPU 312C]". The menu bar includes Symbol Table, Edit, Insert, View, Options, Window, and Help. The toolbar contains icons for file operations and editing. A dropdown menu shows "All Symbols". Below the toolbar is a table with the following data:

	Status	Symbol	Address	Data type	Comment
1		I0.0	I 0.0	BOOL	
2		I0.1	I 0.1	BOOL	
3		I0.2	I 0.2	BOOL	
4		I0.3	I 0.3	BOOL	
5		I0.4	I 0.4	BOOL	
6		I0.5	I 0.5	BOOL	
7		I0.6	I 0.6	BOOL	
8		I0.7	I 0.7	BOOL	

b. Click **Export** to export the edited file and click **Save**.

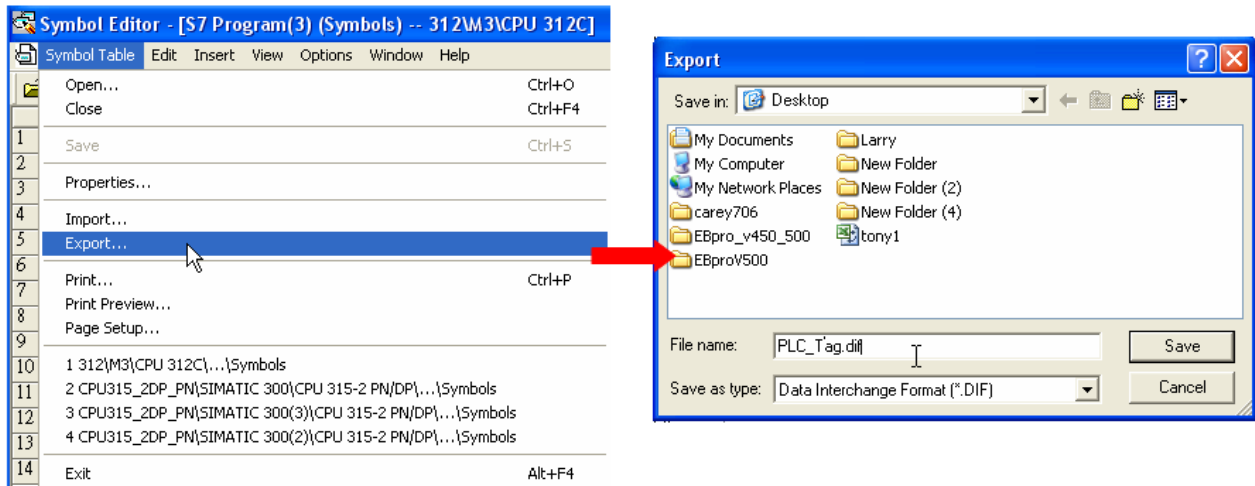

2. Building *.AWF File

a. In **Blocks** create items as shown below:

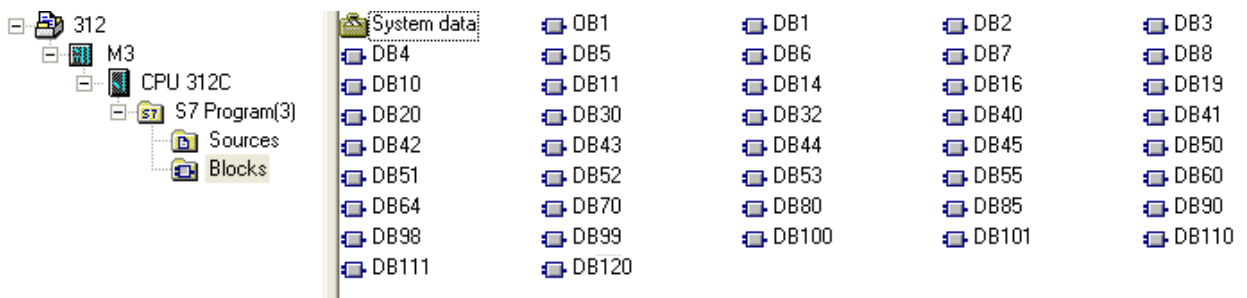

b. Open LAD/STL, FBD – Programming S7 Blocks, click **File -> Generate Source**.

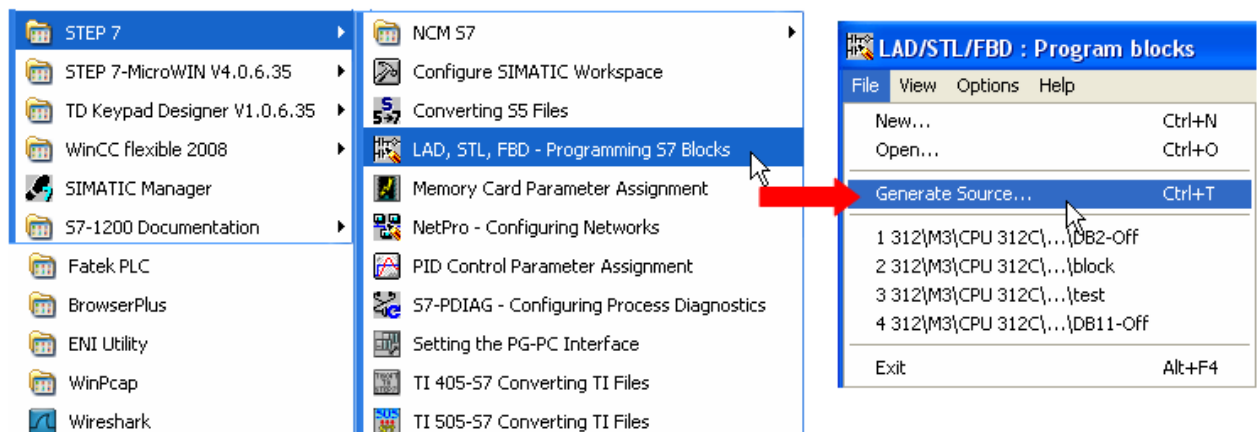

- c ․ Select **Sources** as storage path, specify the file name then click **OK**.

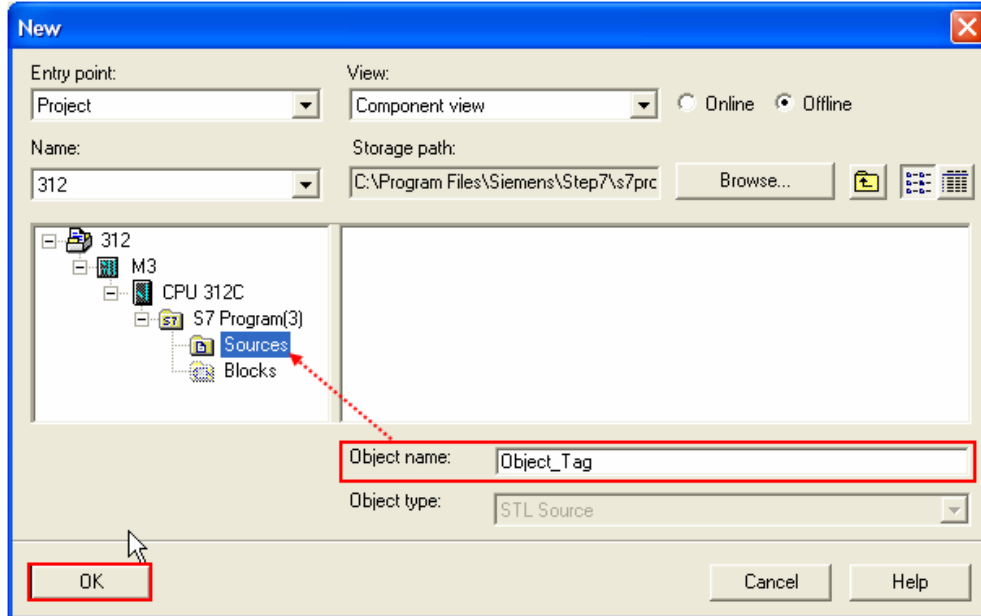

- d ․ Select the objects to be exported then click **OK**.

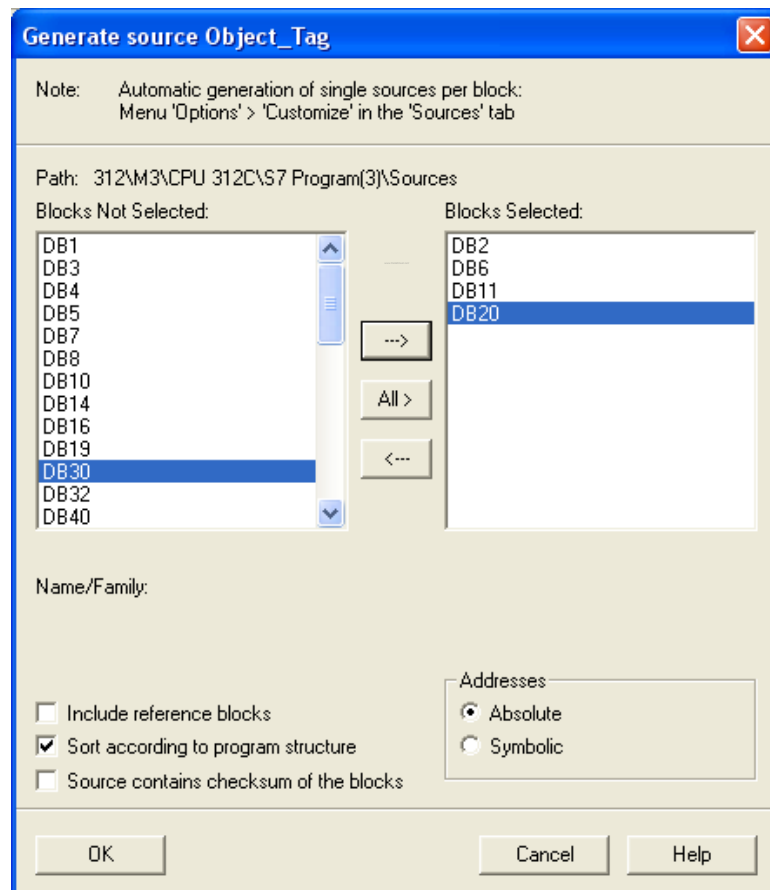

- e、 Under **Sources** there will be names of the saved files, select **Export Source** to build *.AWL file.

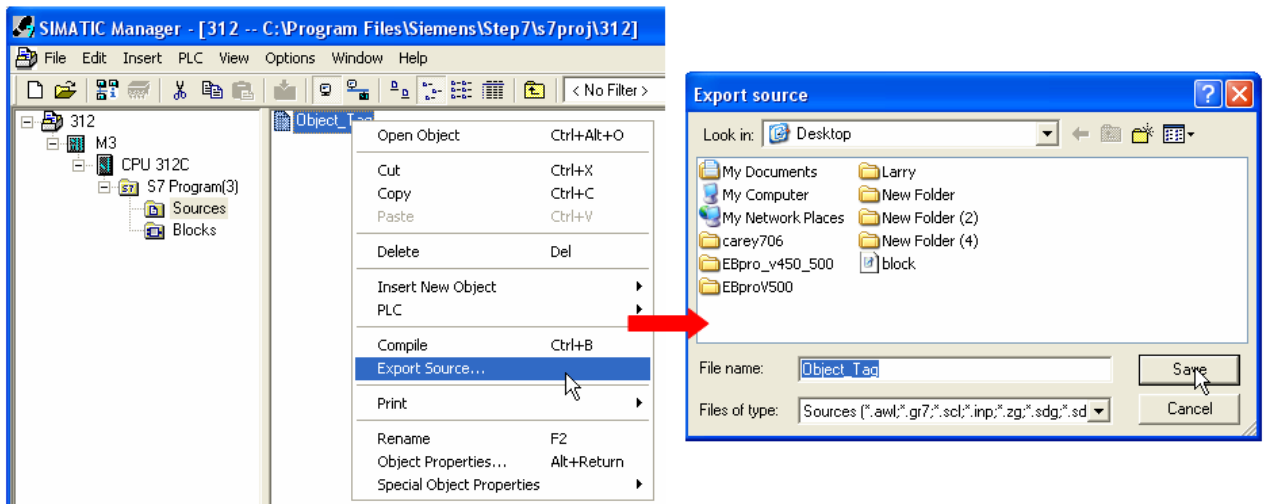

The generated *.dif and *.AWL files can be imported in EasyBuilder8000/EasyBuilderPro **System Parameter Settings**, by clicking **Import Tag**.

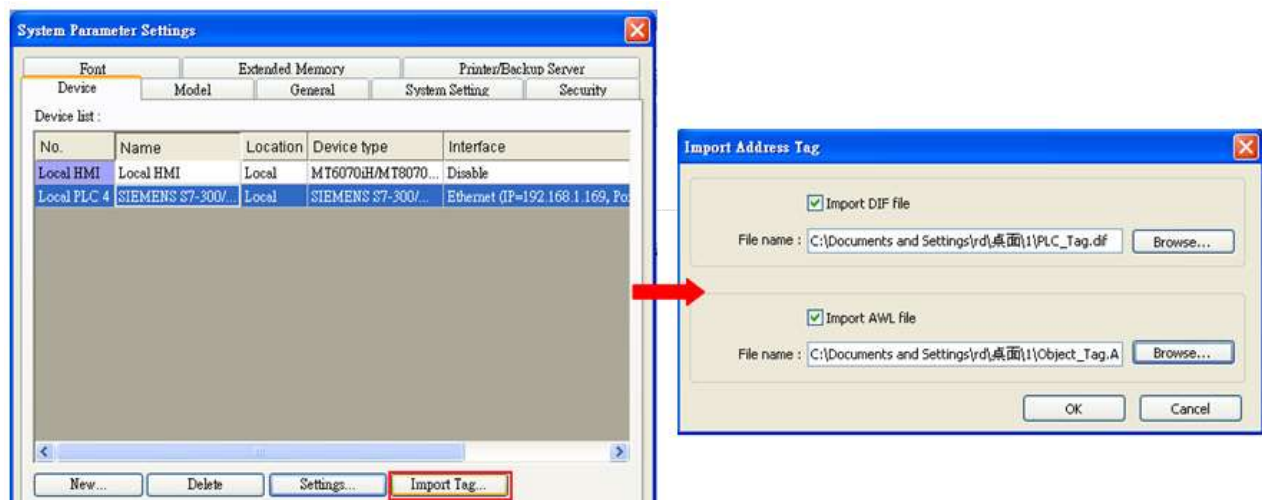

Tag information successfully imported.



Wiring Diagram:

Direct connect (crossover cable):

HMI RJ45 Male	Wire Color	PLC RJ45 Male
1 TX+	White/Orange	3 RX+
2 TX-	Orange	6 RX-
3 RX+	White/Green	1 TX+
4 BD4+	Blue	4 BD4+
5 BD4-	White/Blue	5 BD4-
6 RX-	Green	2 TX-
7 BD3+	White/Brown	7 BD3+
8 BD3-	Brown	8 BD3-



Through a hub:

HMI RJ45 Male	Wire Color	PLC RJ45 Male
1 TX+	White/Orange	1 TX+
2 TX-	Orange	2 TX-
3 RX+	White/Green	3 RX+
4 BD4+	Blue	4 BD4+
5 BD4-	White/Blue	5 BD4-
6 RX-	Green	6 RX-
7 BD3+	White/Brown	7 BD3+
8 BD3-	Brown	8 BD3-



Driver Version:

Version	Date	Description
V2.10	May/21/2011	Added registers: MB & DBBn.

XINJE XC Series

Supported Series: XINJE XC Series

Website: <http://www.xinje.com/0/index.html>

HMI Setting:

Parameters	Recommended	Options	Notes
PLC type	XINJE XC Series		
PLC I/F	RS232	RS232	
Baud rate	19200		
Data bits	8		
Parity	Even		
Stop bits	1		
PLC sta. no.	1	0-255	



Device Address:

Bit/Word	Device type	Format	Range	Memo
B	M	DDDD	0 ~ 8511	
B	X	O000	0 ~ 1037	
B	Y	O000	0 ~ 1037	
B	S	DDDD	0 ~ 1023	
B	T	DDD	0 ~ 618	
B	C	DDD	0 ~ 634	
W	D	DDDD	0 ~ 8511	
W	TD	DDD	0 ~ 618	
W	CD	DDD	0 ~ 634	
W	FD_1	DDDD	0 ~ 5000	
W	FD_2	DDDD	8000 ~ 8511	





Wiring Diagram:

The following represents the view of HMI & PLC.



Driver Version: eMT3000 series

COM1 RS232 9P D-Sub Female	COM3 RS232 9P D-Sub Female		RS232 8P Mini-Din Male
2 RX	8 RX		5 TX
3 TX	7 TX		4 RX
5 GND	5 GND		8 GND
			

MT6000/8000 series except MT6050i/MT8050i

COM1 RS232 9P D-Sub Female	COM2 RS232 9P D-Sub Female	COM3 RS232 9P D-Sub Male	RS232 8P Mini-Din Male
2 RX	6 RX	8 RX	5 TX
3 TX	4 TX	7 TX	4 RX
5 GND	5 GND	5 GND	8 GND
			

MT6050i/MT8050i

COM1 RS232 9P D-Sub Female			RS232 8P Mini-Din Male
9 RX			5 TX
6 TX			4 RX
5 GND			8 GND
			

Version	Date	Description
V1.00	Jul/02/2009	Driver released.

YAMAHA ERCD

HMI Setting:

Parameters	Recommended	Options	Notes
PLC type	YAMAHA ERCD		
PLC I/F	RS232		
Baud rate	9600	1200-19200	
Data bits	8	7 or 8	
Parity	Odd	None/Even/Odd	
Stop bits	1	1 or 2	
PLC sta. no.	0		Needn't to set the station No.



Device Address:

Bit/Word	Device type	Format	Range	Memo
Word	P	DDD	0 ~ 999	Read/Write, PNT point data
Word	SWI	D	0	Write only , RW0=program number , Switches program number to run
Word	ORG	D	0	Write only , returns to origin
Word	RESET	D	0	Write only , reset program
Word	RUN	D	0	Write only , starts automatic operation
Word	X_ADD	D	0	Write only , X+ command
Word	X_SUB	D	0	Write only , X- command
Word	MOVD	D	0	Write only , directly moves to specified position RW1=X-axis position(mm), RW2=speed





Wiring Diagram:

The following represents the view of HMI & PLC.



eMT3000 series

COM1 RS232 9P D-Sub Female	COM3 RS232 9P D-Sub Female		RS232 9P D-Sub Male
2 RX	8 RX		3 TX
3 TX	7 TX		2 RX
5 GND	5 GND		5 GND
			7 RTS
			8 CTS
			circuit
			

MT6000/8000 series except MT6050i/MT8050i

COM1 RS232 9P D-Sub Female	COM2 RS232 9P D-Sub Female	COM3 RS232 9P D-Sub Male	RS232 9P D-Sub Male
2 RX	6 RX	8 RX	3 TX
3 TX	4 TX	7 TX	2 RX
5 GND	5 GND	5 GND	5 GND
			7 RTS
			8 CTS
			circuit
			

MT6050i/MT8050i

COM1 RS232 9P D-Sub Female			RS232 9P D-Sub Male
9 RX			3 TX
6 TX			2 RX
5 GND			5 GND
			7 RTS
			8 CTS
			circuit
			

Driver Version:

Version	Date	Description
V1.30	Jan/04/2010	

YASKAWA CCMEP

Supported Series: YASKAWA CCMEP-100/ CCMEP-200

Website: <http://www.yaskawa-control.co.jp/english/jigyo/mechatronics.html>

HMI Setting:

Parameters	Recommended	Options	Notes
PLC type	YASKAWA CCMEP		
PLC I/F	RS485 4W		
Baud rate	38400		
Data bits	8		
Parity	Even		
Stop bits	1		
PLC sta. no.	1		



Device Address:

Bit/Word	Device type	Format	Range	Memo
B	4_Bit	DDDDDDdd	100 ~ 6553515	
W	4	DDDDD	1 ~ 65535	



Wiring Diagram:

The following represents the view of HMI & PLC.



eMT3000 series

COM1 RS485 4W 9P D-Sub Male			RS485 4W 8P RJ45 Male
1 RX-			4 TX-
2 RX+			3 TX+
3 TX-			2 RX-
4 TX+			1 RX+
5 GND			8 GND
			

MT6000/8000 series except MT6050i/MT8050i

COM1 RS485 4W 9P D-Sub Male			RS485 4W 8P RJ45 Male
1 RX-			4 TX-
2 RX+			3 TX+
3 TX-			2 RX-
4 TX+			1 RX+
5 GND			8 GND
			

MT6050i/MT8050i

COM1 RS485 4W 9P D-Sub Female			RS485 4W 8P RJ45 Male
1 RX-			4 TX-
2 RX+			3 TX+
3 TX-			2 RX-
4 TX+			1 RX+
5 GND			8 GND
			

Driver Version:

Version	Date	Description
V1.00	Jun/14/2012	Driver released.

YASKAWA Memobus (MP Series Controllers)

Supported Series: YASKAWA MP2200, MP2300, MP2300S, MP9xx communication module.

Website: <http://www.yaskawa.com/>

HMI Setting:

Parameters	Recommended	Options	Notes
PLC type	YASKAWA Memobus (MP Series Controllers)		
PLC I/F	RS485/Ethernet	RS232/RS485 2w/4w, Ethernet	
Baud rate	19200	9600~57600	
Data bits	8		
Parity	Even		
Stop bits	1		
Port no.	502	default	Ethernet Module Only
PLC sta. no.	1	1-31	

PLC Setting:

Communication mode	MEMOBUS, Slave, RTU
--------------------	---------------------

PLC Ethernet Setting:

1. Use MPE720 program software, open Module Configuration, double click "218IFA".

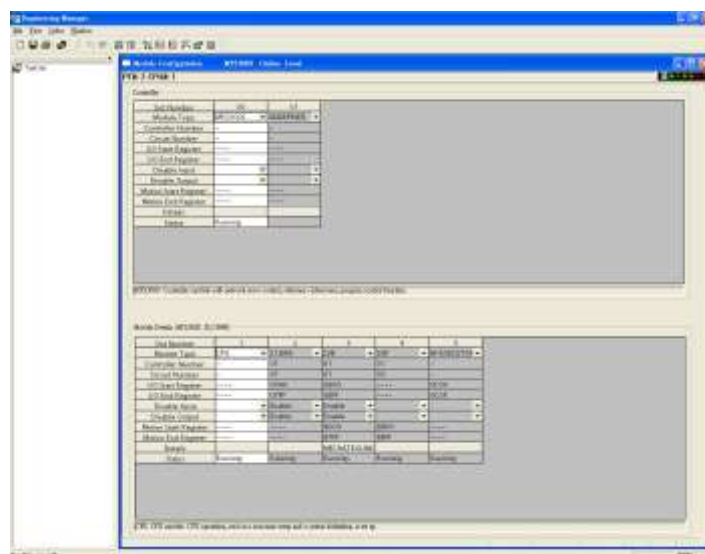

- In Transmission Parameters input MP2300S IP address, Subnet Mask, Gateway IP.
 In Connection Parameter, CNO -1 input: Local Port=502, Node IP address=000.000.000.000, Node Port=00000, Connect Type=TCP, Protocol Type=MEMOBUS, Code=RTU.

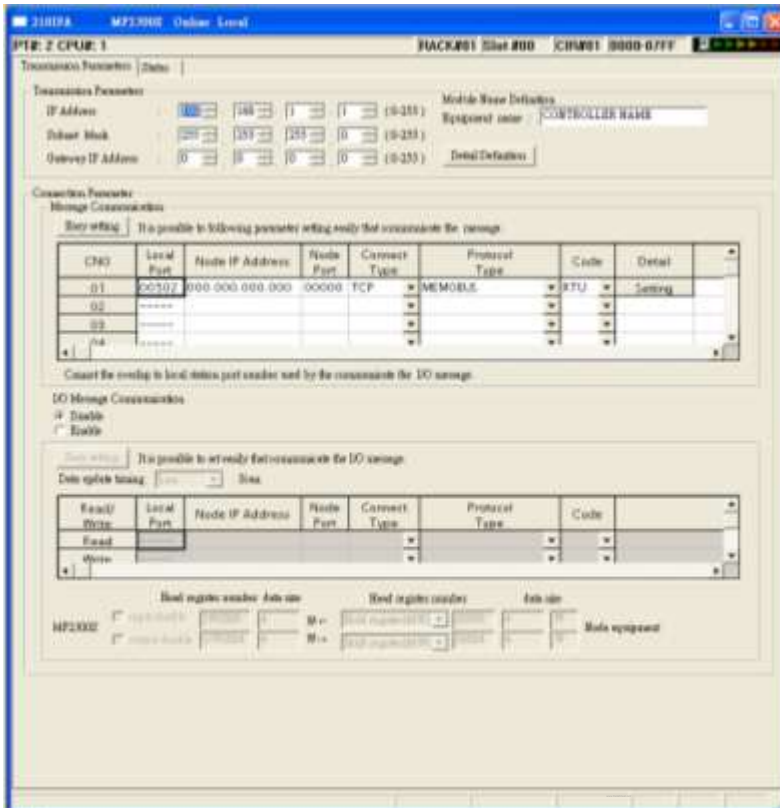

- Click MECHATROLINK to set up MP2300S PLC as Master.

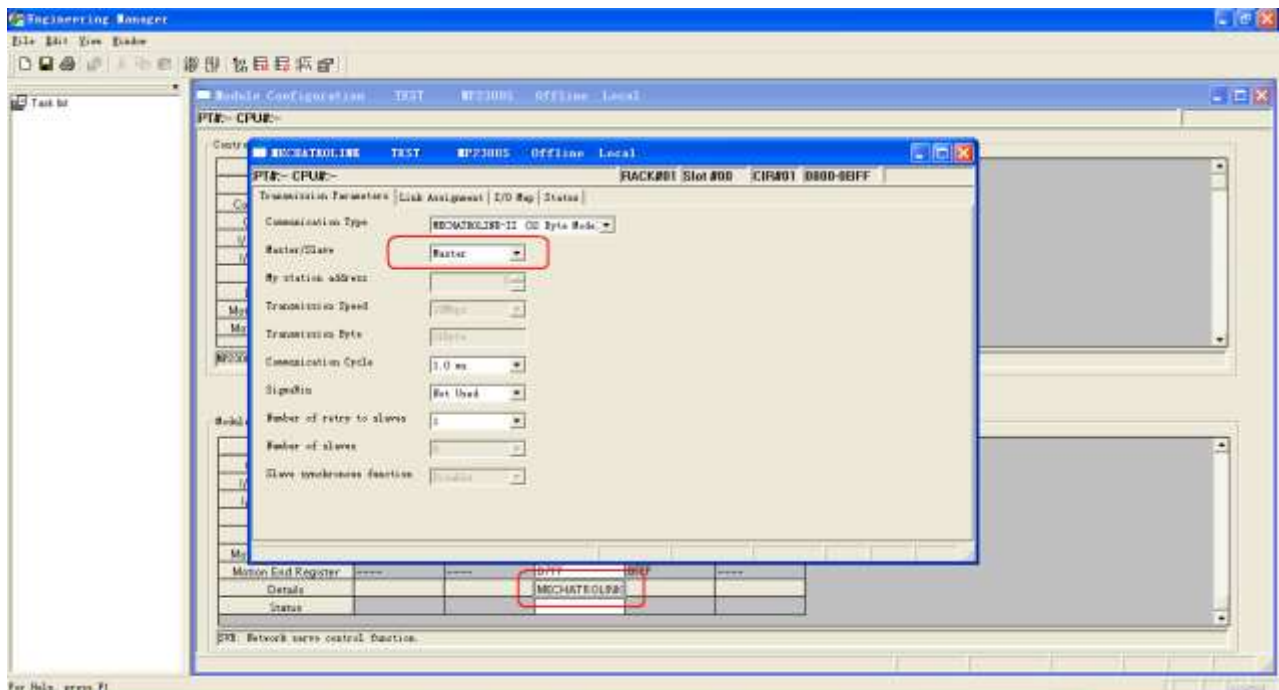

- Close all dialogs and save to MP2300S.

Note:

1. Only CNO 01 can auto communicate with one HMI. Other CNO need a ladder program created for communication.
2. DIP SW2-2 of MP2300S must be set to OFF position during normal communication, otherwise, IP address will be erased after reset power, and it will be unable to communicate with HMI when set to ON position.

Device Address:

Bit/Word	Device type	Format	Range	Memo
B	MB_1	DDDDh	0 ~ 9999f	MB 0 ~ 9999
B	MB_2	DDDDh	100000 ~ 65534f	MB 10000 ~ 65535
B	IB	HHHHH	0 ~ a7ff0	Read only
B	IW_Bit	HHHHdd	0~ a7ff15	
W	IW	HHHH	0 ~ a7ff	Read only
DW	IL	HHHH	0 ~ a7ff	Read only
DW (F)	IF	HHHH	0 ~ a7ff	Read only
W	MW	DDDDD	0 ~ 65534	Holding register
DW	ML	DDDDD	0 ~ 65533	Double word
DW (F)	MF	DDDDD	0 ~ 65533	Floating point



*: When connect via Ethernet interface the max range of IW, IL and IF would be restricted.

Wiring Diagram:





The following represents the view of HMI & PLC.

9P D-Sub to 9P D-Sub: 217IF-01, 218IF-01



eMT3000 series

COM1 RS232 9P D-Sub Female	COM3 RS232 9P D-Sub Female		RS232 9P D-Sub Male
2 RX	8 RX		2 TX
3 TX	7 TX		3 RX
5 GND	5 GND		7 GND
			

MT6000/8000 series except MT6050i/MT8050i

COM1 RS232 9P D-Sub Female	COM2 RS232 9P D-Sub Female	COM3 RS232 9P D-Sub Male	RS232 9P D-Sub Male
2 RX	6 RX	8 RX	2 TX
3 TX	4 TX	7 TX	3 RX
5 GND	5 GND	5 GND	7 GND
			

MT6050i/MT8050i

COM1 RS232 9P D-Sub Female			RS232 9P D-Sub Male
9 RX			2 TX
6 TX			3 RX
5 GND			7 GND
			



The following represents the view of HMI & PLC.

217IF-01 RS485 2W:



eMT3000 series

COM1 RS485 2W 9P D-Sub Male	COM3 RS485 2W 9P D-Sub Male		217IF-01 RS485 14P Connector
1 RX-	6 Data-		2, 4 D-
2 RX+	9 Data+		1, 3 D+
5 GND	5 GND		14 GND
			

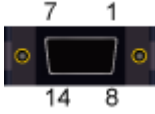
MT6000/8000 series except MT6050i/MT8050i

COM1 RS485 2W 9P D-Sub Male	COM3 RS485 2W 9P D-Sub Male		217IF-01 RS485 14P Connector
1 RX-	6 Data-		2, 4 D-
2 RX+	9 Data+		1, 3 D+
5 GND	5 GND		14 GND
			

MT6050i/MT8050i

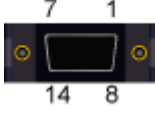
COM1 RS485 2W 9P D-Sub Female	COM3 RS485 2W 9P D-Sub Female		217IF-01 RS485 14P Connector
1 RX-	7 Data-		2, 4 D-
2 RX+	8 Data+		1, 3 D+
5 GND	5 GND		14 GND
			

The following represents the view of HMI & PLC.

217IF-01 RS4854W:

eMT3000 series

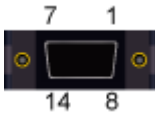
COM1 RS485 4W 9P D-Sub Male			217IF-01 RS422 14P Connector
1 RX-			2 TX-
2 RX+			1 TX+
3 TX-			4 RX-
4 TX+			3 RX+
5 GND			14 GND
			

MT6000/8000 series except MT6050i/MT8050i

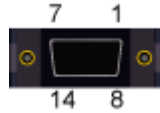
COM1 RS485 4W 9P D-Sub Male			217IF-01 RS422 14P Connector
1 RX-			2 TX-
2 RX+			1 TX+
3 TX-			4 RX-
4 TX+			3 RX+
5 GND			14 GND
			

MT6050i/MT8050i

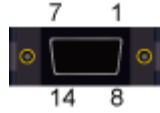
COM1 RS485 4W 9P D-Sub Female			217IF-01 RS422 14P Connector
1 RX-			2 TX-
2 RX+			1 TX+
3 TX-			4 RX-
4 TX+			3 RX+
5 GND			14 GND
			

Direct connect (crossover cable):

HMI RJ45 Male	Wire Color	PLC RJ45 Male
1 TX+	White/Orange	3 RX+
2 TX-	Orange	6 RX-
3 RX+	White/Green	1 TX+
4 BD4+	Blue	4 BD4+
5 BD4-	White/Blue	5 BD4-
6 RX-	Green	2 TX-
7 BD3+	White/Brown	7 BD3+
8 BD3-	Brown	8 BD3-



Through a hub:

HMI RJ45 Male	Wire Color	PLC RJ45 Male
1 TX+	White/Orange	1 TX+
2 TX-	Orange	2 TX-
3 RX+	White/Green	3 RX+
4 BD4+	Blue	4 BD4+
5 BD4-	White/Blue	5 BD4-
6 RX-	Green	6 RX-
7 BD3+	White/Brown	7 BD3+
8 BD3-	Brown	8 BD3-



Driver Version:

Version	Date	Description
V1.70	Dec/20/2010	

YASKAWA MP Series Ethernet (Extension)

HMI Setting:

Parameters	Recommended	Options	Notes
PLC type	YASKAWA MP Series Ethernet (Extension)		
PLC I/F	Ethernet (UDP)		
Port no.	10000		
PLC sta. no.	1		

PLC Setting:

Yaskawa PLC Communication Parameter Settings

(1) PLC Factory Communication Parameter Settings:

Item	Set
IP Address	192.168.1.1
Subnet Mask	255.255.255.0
Gateway IP Address	0.0.0.0
System Port No.	10000 (UDP)
TCP Zero Window Timer Value	3 (s)
TCP Retry Time	500 (ms)
TCP Close Time	60 (s)
IP Assemble Time	30 (s)
Max. Packet Length	1500 (bytes)

(2) Setting Steps:

1. Set IP for PLC.

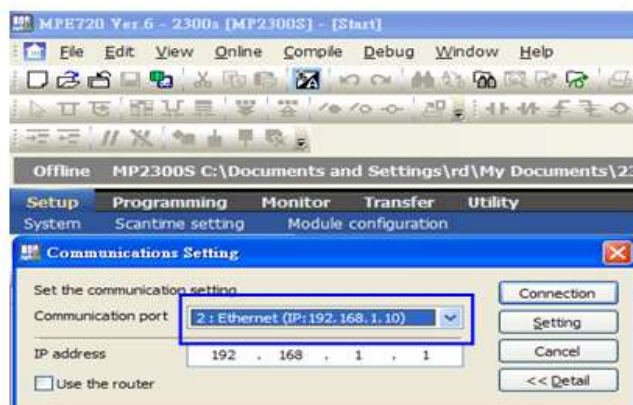

2. Communication parameter setting.



3. Go to Module Details and select [2181FA] for setting relevant parameters for Ethernet transmission.

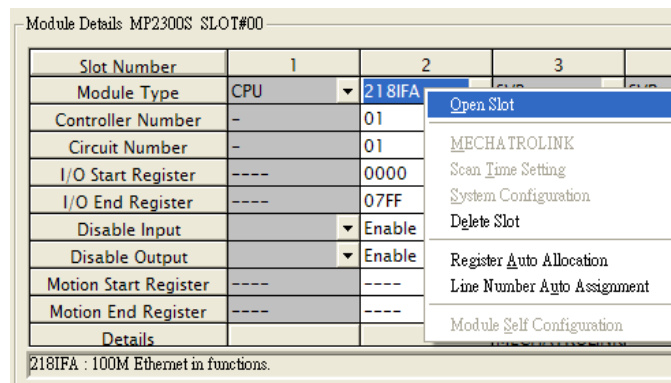

4. The settings are shown below, PLC IP can't be repeated.

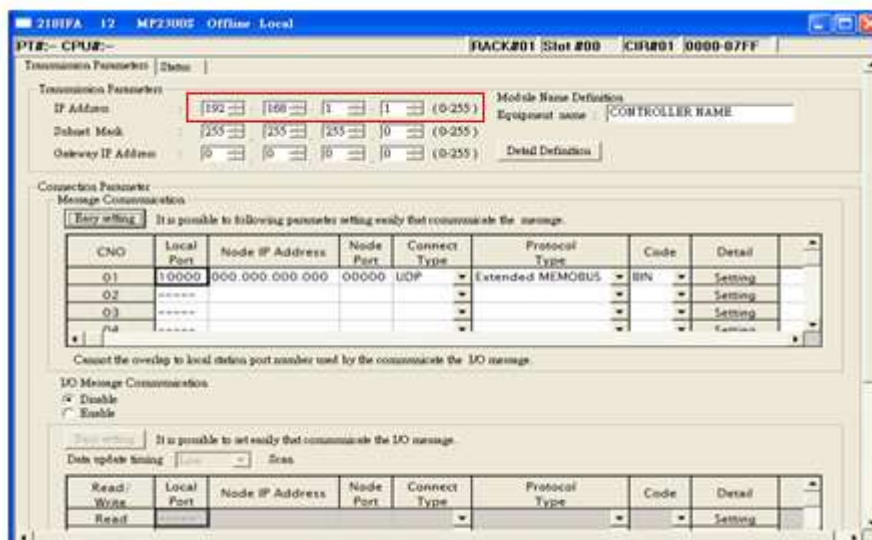

5. Download PLC communication parameters to PLC, and restart the controller.

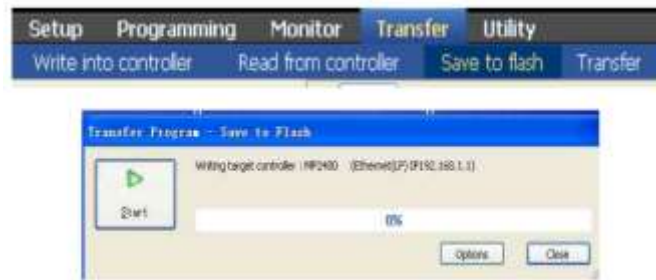

(3) HMI Settings:

1. Select Ethernet for PLC I/F.
2. Tick [UDP].
3. Set PLC IP and Port, the default Port is 10000.



Device Address:

Bit/Word	Device type	Format	Range	Memo
B	SB	DDDDh	0 ~ 8191f	
B	IB	HHHHh	0 ~ ffff	
B	OB	HHHHh	0 ~ ffff	
B	MB	DDDDh	0 ~ 65534f	
W	SW	DDDD	0 ~ 8191	
W	IW	HHHH	0 ~ ffff	
W	OW	HHHH	0 ~ ffff	
W	MW	DDDD	0 ~ 65534	

Wiring Diagram:

Direct connect (crossover cable):

HMI RJ45 Male	Wire Color	PLC RJ45 Male
1 TX+	White/Orange	3 RX+
2 TX-	Orange	6 RX-
3 RX+	White/Green	1 TX+
4 BD4+	Blue	4 BD4+
5 BD4-	White/Blue	5 BD4-
6 RX-	Green	2 TX-
7 BD3+	White/Brown	7 BD3+
8 BD3-	Brown	8 BD3-



Through a hub:

HMI RJ45 Male	Wire Color	PLC RJ45 Male
1 TX+	White/Orange	1 TX+
2 TX-	Orange	2 TX-
3 RX+	White/Green	3 RX+
4 BD4+	Blue	4 BD4+
5 BD4-	White/Blue	5 BD4-
6 RX-	Green	6 RX-
7 BD3+	White/Brown	7 BD3+
8 BD3-	Brown	8 BD3-



Driver Version:

Version	Date	Description
V1.10	Jul/21/2011	Driver released.

YASKAWA MP2300Siec

Website: <http://www.yaskawa.com/site/home.nsf/home/home.html>

HMI Setting:

Parameters	Recommended	Options	Notes
PLC type	YASKAWA MP2300Siec		
PLC I/F	Ethernet		
Port no.	44818		
Assembly instance	Input::101 Output:111	Input::101~106 Output:111~116	
PLC sta. no.	1		

PLC Setting:

MP2300Siec-Motion Works IEC Express (YASKAWA) Settings:

Step 1. Before HMI communicates with MP2300Siec using Ethernet/IP, the Instance Input and Instance Output of MP2300Siec device must be set correctly. Multiple Instances are allowed to be built at one time, please click [Save] after setting.

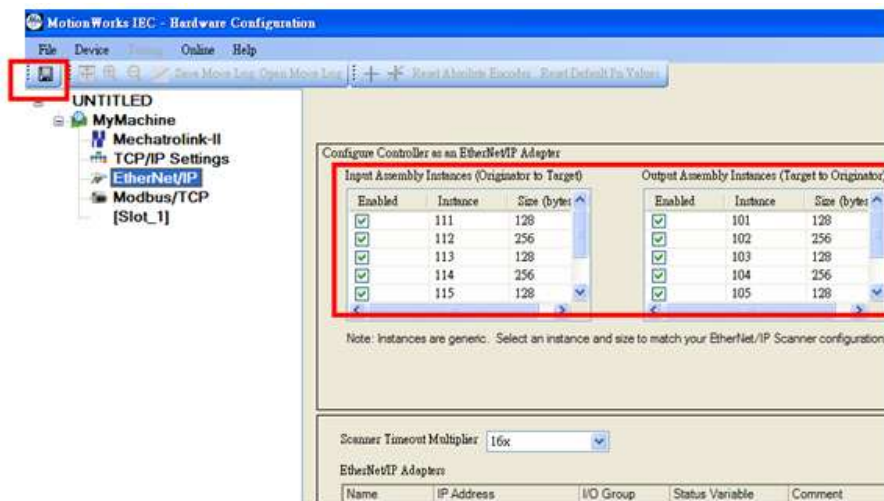

Fig. 1 Assembly Instances

Step 2. Global Variables will automatically add in E/IP Input and Output data, Input and Output data name and address type can be user-defined.

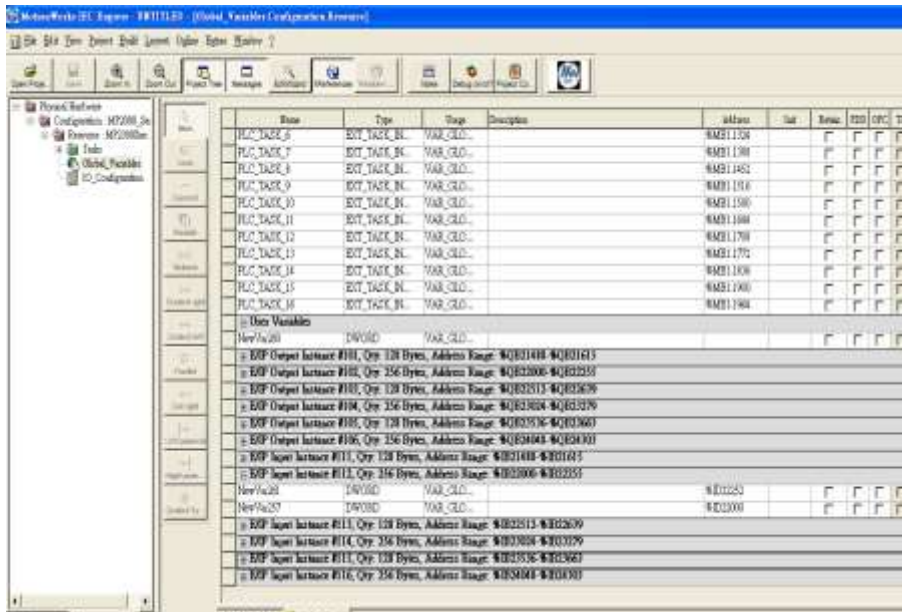

Fig. 2 Global Variables

Step 3. When download Project to device (MP2300Siec), please go to (Fig. 3) Resource->Settings to access setting dialog (Fig. 4) for setting MP2300Siec IP address.

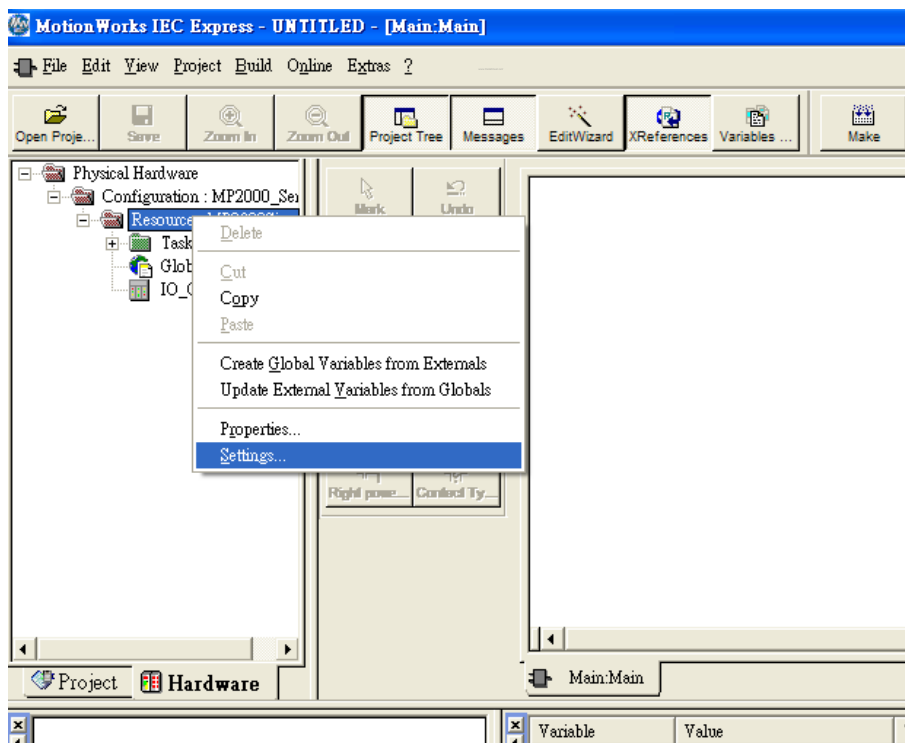

Fig. 3 Motion Works IEC Express – Settings

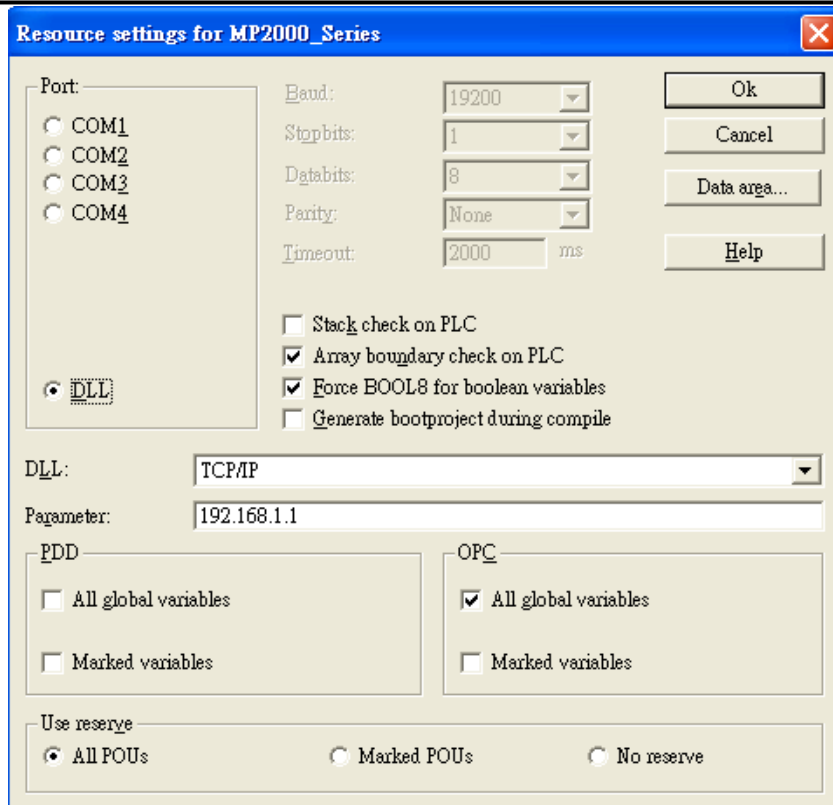

Fig. 4 Resource Settings

Step 4. Start compilation.

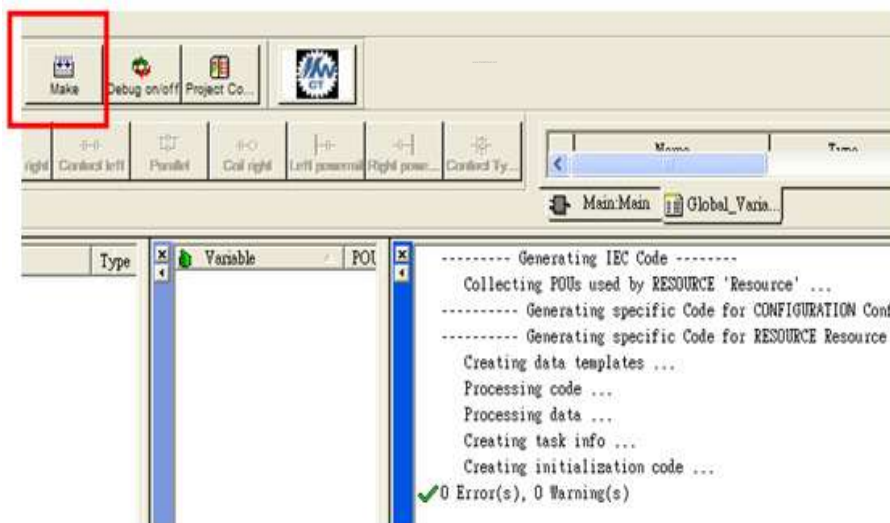

Fig. 5 Editing Screen

Step 5. Download project to device- MP2300Siec, and execute Cold.



Fig. 6 Project Downloading

EasyBuilder8000/EasyBuilder Pro Settings:

Step 1. System Parameter Settings

Open EasyBuilder8000/EasyBuilder Pro project, as shown in Fig. 7, Assembly Instance and Size must match the software default factory settings, and please don't select UDP. Fig.8 below shows how HMI Input / Output address is mapped to MP2300Siec device.

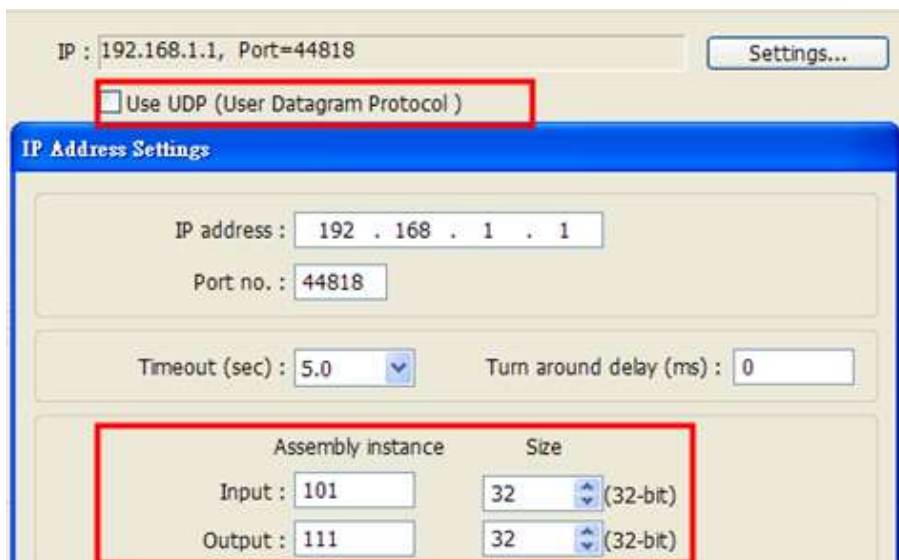

Fig. 7 Instance Setting

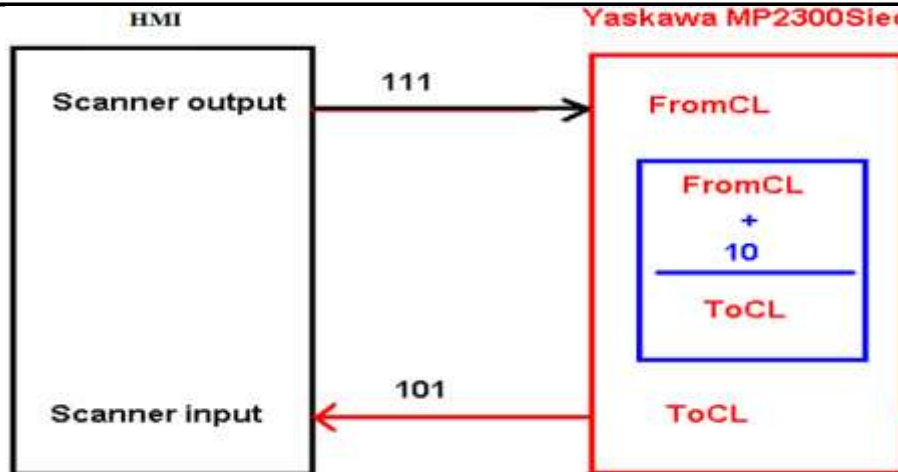

Fig.8 HMI and MP2300Siec I/O Mapping

Step 2. Address Setting:

Instance 101 and Instance 111 are defined as 128Bytes, on the project window , WORD objects can be used, with data typed defined as 32-Bit Unsigned, Input addresses set to 0、2、4、6.....62 for reading Instance 101 data.

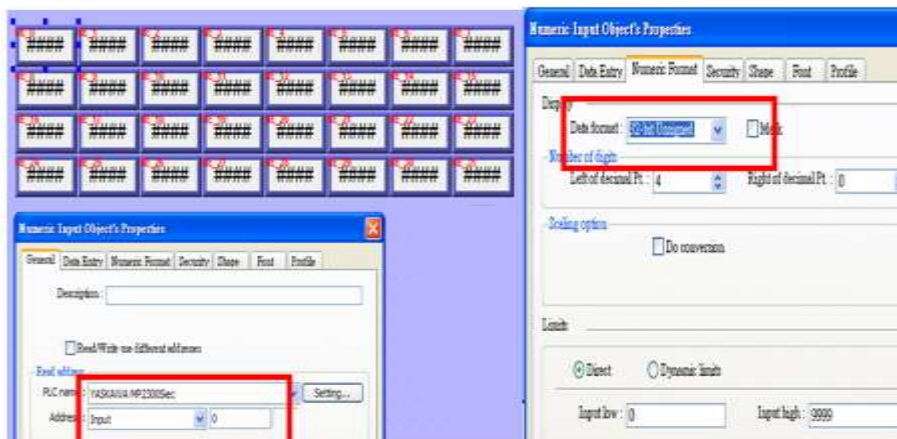

Fig. 9 Address Setting

EasyBuilder8000/EasyBuilder Pro-Allen Bradley CompactLogix Tag Data Importing and Module Defined:

Step 1. In EasyBuilder8000/EasyBuilder Pro project, when using Allen Bradley EIP driver to import CSV file (as in Fig. 10), please open AB Data Type Editor (Fig. 11), and right click on Module Defined to add New Data Type.

	A	B	C	D	E	F
1	remark	CSV-Import-Export				
2	remark	Date = Fri Jul 22 15:40:47 2011				
3	remark	Version = RSLogix 5000 v18.00				
4	remark	Owner = user				
5	remark	Company = abc				
6		0.3				
7	TYPE	SCOPE	NAME	DESCRIPTION	DATA TYPE	SPECIFIER
8	TAG		MP2300Sec:C		AB:ETHERNET_MODULE:C:0	
9	TAG		MP2300Sec:I		AB:ETHERNET_MODULE_DINT_128Bytes:I:0	
10	TAG		MP2300Sec:O		AB:ETHERNET_MODULE_DINT_128Bytes:O:0	
11	TAG		Local:1:C		AB:Embedded_IQ16F:C:0	
12	TAG		Local:1:I		AB:Embedded_IQ16F:I:0	
13	TAG		Local:2:C		AB:Embedded_OB16:C:0	
14	TAG		Local:2:I		AB:Embedded_OB16:I:0	
15	TAG		Local:2:O		AB:Embedded_OB16:O:0	
16	TAG		Bits		BOOL[32]	
17	TAG		Timer1		TIMER	
18						
19						

Fig. 10 RSLogix 5000 (Allen Bradley Software) Export Free Tag CSV File

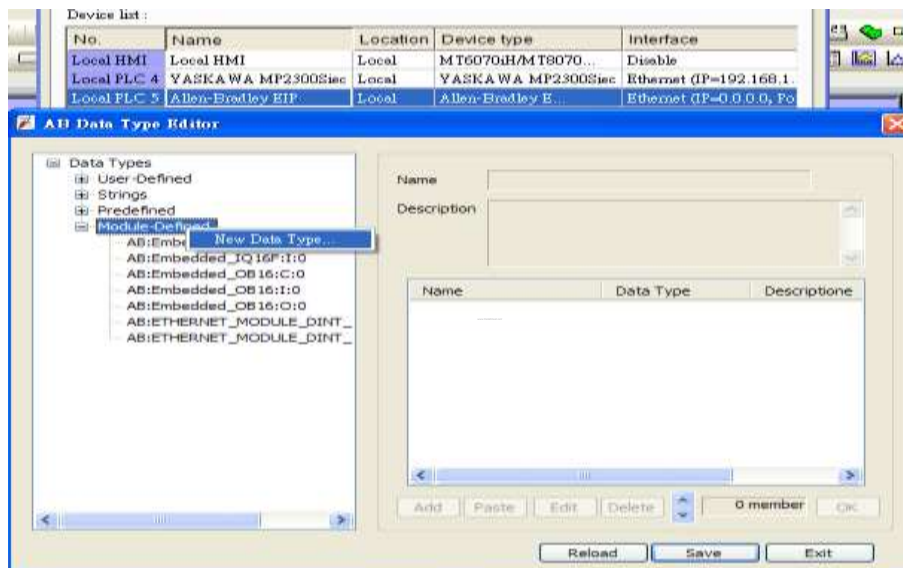

Fig.11 AB Data Type Editor

Step 2. As in Fig 12, in AB Data Type Editor add Name of the new data type. The Name must be set identically to the Data Type in Free Tag CSV file. As in Fig 14, Data Member Name must be set identically to the AB software (as Data in Fig. 13), then click [Save] (Fig. 15).

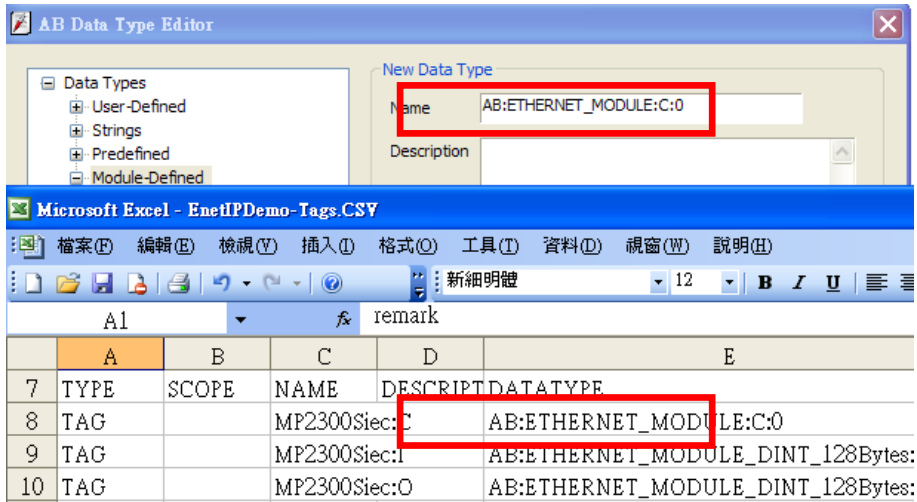

Fig.12 AB Data Type Editor

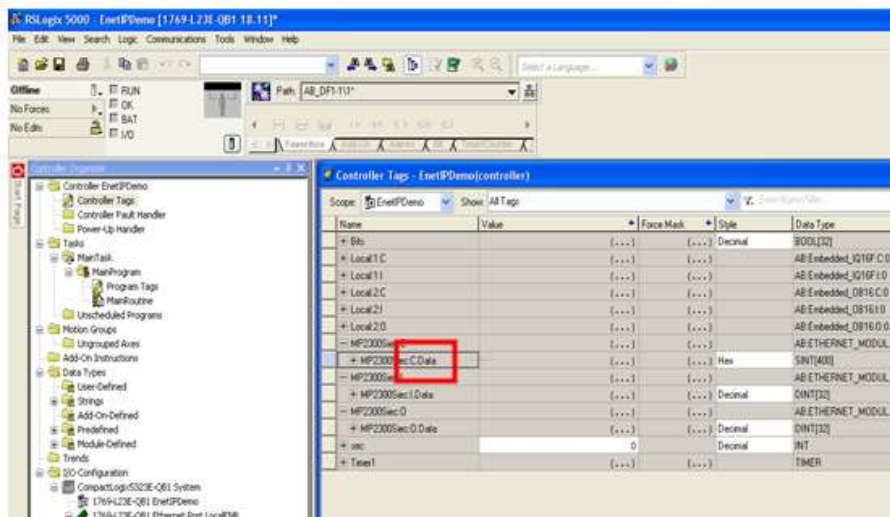

Fig.13 Tag Information

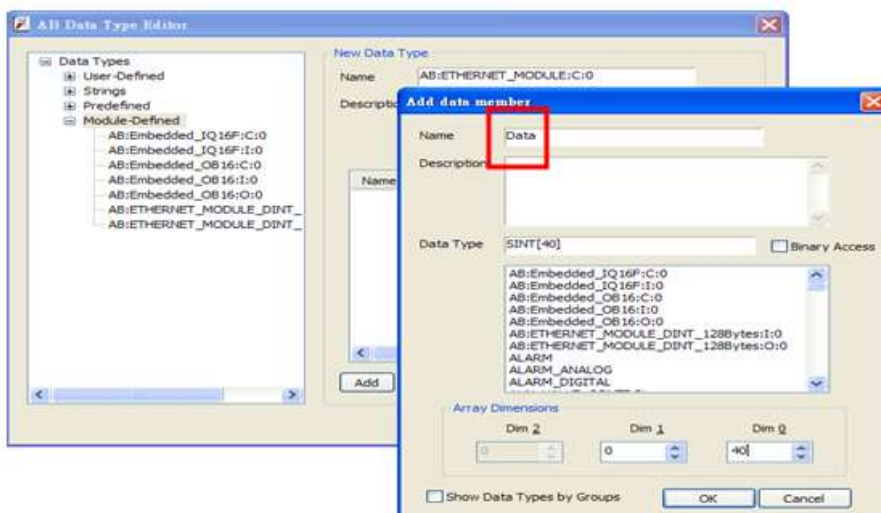

Fig.14 Add Data Member - Name Tag Information

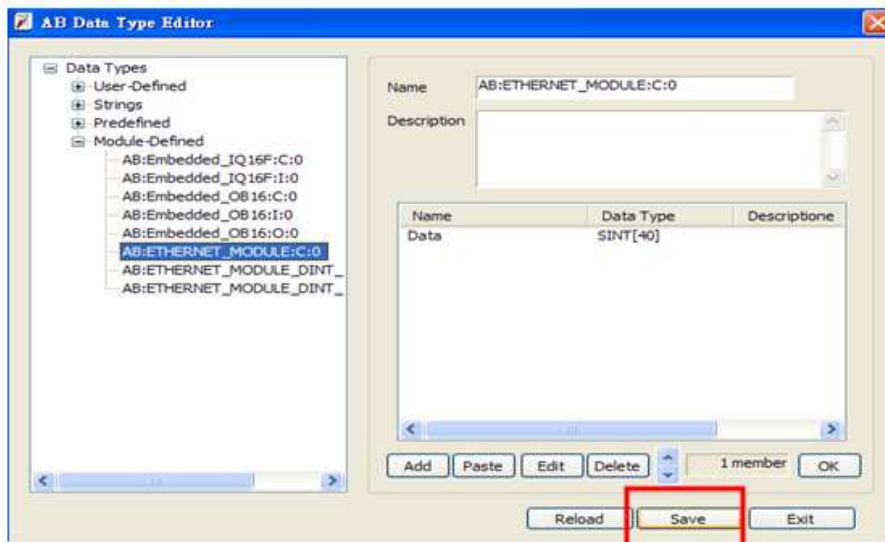

Fig. 15 Add Data Member-Settings - Save

Step 3. Import CSV file, Tag Information can be viewed from object address.

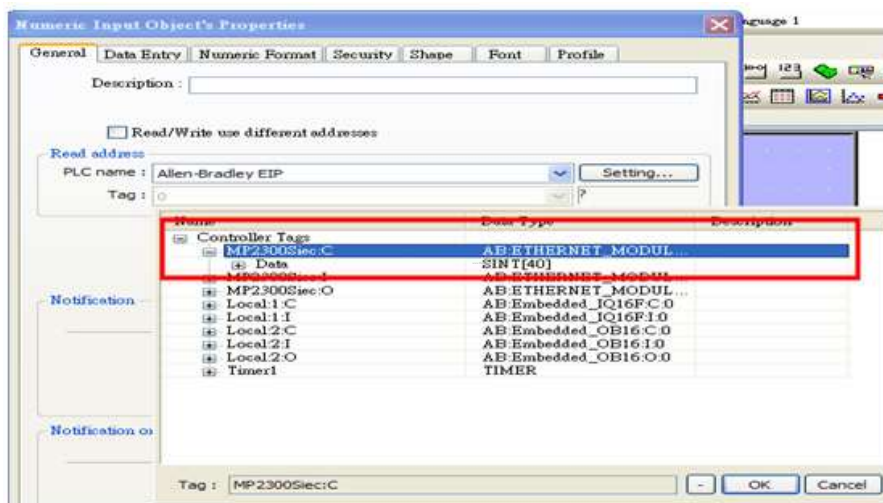

Fig.16 Tag Information

Device Address:

Bit/Word	Device type	Format	Range	Memo
B	Input_Bit	DDDDdd	0 ~ 6553515	
B	Output_Bit	DDDDdd	0 ~ 6553515	
DW	Input	DDDD	0 ~ 65535	
DW	Output	DDDD	0 ~ 65535	

Wiring Diagram:

Direct connect (crossover cable):

HMI RJ45 Male	Wire Color	PLC RJ45 Male
1 TX+	White/Orange	3 RX+
2 TX-	Orange	6 RX-
3 RX+	White/Green	1 TX+
4 BD4+	Blue	4 BD4+
5 BD4-	White/Blue	5 BD4-
6 RX-	Green	2 TX-
7 BD3+	White/Brown	7 BD3+
8 BD3-	Brown	8 BD3-



Through a hub:

HMI RJ45 Male	Wire Color	PLC RJ45 Male
1 TX+	White/Orange	1 TX+
2 TX-	Orange	2 TX-
3 RX+	White/Green	3 RX+
4 BD4+	Blue	4 BD4+
5 BD4-	White/Blue	5 BD4-
6 RX-	Green	6 RX-
7 BD3+	White/Brown	7 BD3+
8 BD3-	Brown	8 BD3-



Note: The wiring diagrams above are drawn based on MT8100i structure, the actual placement of pins may vary according to HMI module.

Driver Version:

Version	Date	Description
V1.00	Aug/24/2011	Driver released.

YASKAWA SMC 3010

Supported Series: YASKAWA SMC Series Servo Motor Controller.

HMI Setting:

Parameters	Recommended	Options	Notes
PLC type	YASKAWA SMC 3010		
PLC I/F	RS232		
Baud rate	19200	9600, 19200	
Data bits	8		
Parity	None		
Stop bits	1		

Device Address:

Bit/Word	Device type	Format	Range	Memo
B	AF	D	0 ~ 1	
B	BN	D	0 ~ 1	Write only
B	BP	D	0 ~ 1	Write only
B	BV	D	0 ~ 1	Write only
B	CB	DDDD	0 ~ 9999	Write only
B	CM	D	0 ~ 1	Read only
B	DV	D	0 ~ 1	
B	EB	D	0 ~ 1	
B	OE	D	0 ~ 1	
B	RS	D	0 ~ 1	Write only
B	ST	D	0 ~ 1	Write only
B	TB	Do	0 ~ 17	Read only
B	V_Bit	DDDdd	0 ~ 99931	*2
B	D_arr_Bit	DDDdd	0 ~ 99931	
DW	AC	D	0 ~ 4	
DW	DC	D	0 ~ 4	
DW	BL	D	0 ~ 4	
W	CD	D	0 ~ 2	Write only
W	CE	D	0 ~ 2	

Bit/Word	Device type	Format	Range	Memo
DW	DE	D	0 ~ 4	
DW	DP	D	0 ~ 4	
W	DT	D	0 ~ 2	
W	EC	D	0 ~ 2	
DW	EM	D	0 ~ 4	
W	ER	D	0 ~ 2	
W	FA	D	0 ~ 2	
DW	FL	D	0 ~ 4	
W	FV	D	0 ~ 2	
DW	GR	D	0 ~ 4	
DW	JG	D	0 ~ 4	
DW	MM	D	0 ~ 4	
W	MT	D	0 ~ 2	
W	NA	D	0 ~ 2	
W	OP	D	0 ~ 2	
DW	PA	D	0 ~ 4	Write only
DW	PR	D	0 ~ 4	
DW	SP	D	0 ~ 4	
W	TC	D	0 ~ 2	Read only
W	TM	D	0 ~ 2	
W	TW	D	0 ~ 2	
DW	VA	D	0 ~ 4	
DW	VD	D	0 ~ 4	
DW	VS	D	0 ~ 4	
DW	IL	D	0 ~ 4	
DW	IT	D	0 ~ 4	
DW	KD	D	0 ~ 4	
DW	KI	D	0 ~ 4	
DW	KP	D	0 ~ 4	
DW	OF	D	0 ~ 4	
DW	TL	D	0 ~ 4	
DW	VR	D	0 ~ 4	
DW	VT	D	0 ~ 4	
DW	PF	D	0 ~ 4	*1
DW	VF	D	0 ~ 4	

Bit/Word	Device type	Format	Range	Memo
DW	V	DDD	0 ~ 999	*2
F	F	DDD	0 ~ 999	*2
W	D_array	DDD	0 ~ 999	
W	R_array	DDD	0 ~ 999	

Note:



*1 PF is the communication parameter of SMC_3010, the default is 10.4, if the value is not 10.4, all values will be displayed incorrectly.

*2 User defined integer variable V000~V999, floating point variable F000~F999.





Wiring Diagram:

The following represents the view of HMI & PLC.



eMT3000 series

COM1 RS232 9P D-Sub Female	COM3 RS232 9P D-Sub Female		SMC3010 CN6 RS232 9P D-Sub Male
2 RX	8 RX		2 TXD
3 TX	7 TX		3 RXD
5 GND	5 GND		5 GND
			7 RTS
			8 CTS
			circuit
			

MT6000/8000 series except MT6050i/MT8050i

COM1 RS232 9P D-Sub Female	COM2 RS232 9P D-Sub Female	COM3 RS232 9P D-Sub Male	SMC3010 CN6 RS232 9P D-Sub Male
2 RX	6 RX	8 RX	2 TXD
3 TX	4 TX	7 TX	3 RXD
5 GND	5 GND	5 GND	5 GND
			7 RTS
			8 CTS
			circuit
			

MT6050i/MT8050i

COM1 RS232 9P D-Sub Female			SMC3010 CN6 RS232 9P D-Sub Male
9 RX			2 TXD
6 TX			3 RXD
5 GND			5 GND
			7 RTS
			8 CTS
			circuit
			

Driver Version:

Version	Date	Description
V1.30	Mar/29/2010	

YASKAWA SMC 3010 (Ethernet)

Supported Series: YASKAWA SMC Series Servo Motor Controller.

HMI Setting:

Parameters	Recommended	Options	Notes
PLC type	YASKAWA SMC 3010 (Ethernet)		
PLC I/F	Ethernet		
Port no.	23		

Device Address:

Bit/Word	Device type	Format	Range	Memo
B	AF	D	0 ~ 1	
B	BN	D	0 ~ 1	Write only
B	BP	D	0 ~ 1	Write only
B	BV	D	0 ~ 1	Write only
B	CB	DDDD	0 ~ 9999	Write only
B	CM	D	0 ~ 1	Read only
B	DV	D	0 ~ 1	
B	EB	D	0 ~ 1	
B	OE	D	0 ~ 1	
B	RS	D	0 ~ 1	Write only
B	ST	D	0 ~ 1	Write only
B	TB	Do	0 ~ 17	Read only
B	V_Bit	DDDdd	0 ~ 99931	*2
B	D_arr_Bit	DDDdd	0 ~ 99931	
DW	AC	D	0 ~ 4	
DW	DC	D	0 ~ 4	
DW	BL	D	0 ~ 4	
W	CD	D	0 ~ 2	Write only
W	CE	D	0 ~ 2	
DW	DE	D	0 ~ 4	
DW	DP	D	0 ~ 4	
W	DT	D	0 ~ 2	
W	EC	D	0 ~ 2	

Bit/Word	Device type	Format	Range	Memo
DW	EM	D	0 ~ 4	
W	ER	D	0 ~ 2	
W	FA	D	0 ~ 2	
DW	FL	D	0 ~ 4	
W	FV	D	0 ~ 2	
DW	GR	D	0 ~ 4	
DW	JG	D	0 ~ 4	
DW	MM	D	0 ~ 4	
W	MT	D	0 ~ 2	
W	NA	D	0 ~ 2	
W	OP	D	0 ~ 2	
DW	PA	D	0 ~ 4	Write only
DW	PR	D	0 ~ 4	
DW	SP	D	0 ~ 4	
W	TC	D	0 ~ 2	Read only
W	TM	D	0 ~ 2	
W	TW	D	0 ~ 2	
DW	VA	D	0 ~ 4	
DW	VD	D	0 ~ 4	
DW	VS	D	0 ~ 4	
DW	IL	D	0 ~ 4	
DW	IT	D	0 ~ 4	
DW	KD	D	0 ~ 4	
DW	KI	D	0 ~ 4	
DW	KP	D	0 ~ 4	
DW	OF	D	0 ~ 4	
DW	TL	D	0 ~ 4	
DW	VR	D	0 ~ 4	
DW	VT	D	0 ~ 4	
DW	PF	D	0 ~ 4	*1
DW	VF	D	0 ~ 4	
DW	V	DDD	0 ~ 999	*2
W	F	DDD	0 ~ 999	*2
W	D_array	DDD	0 ~ 999	
W	R_array	DDD	0 ~ 999	

Note:

*1 PF is the communication parameter of SMC_3010, the default is 10.4, if the value is not 10.4, all values will be displayed incorrectly.

*2 User defined integer variable V000~V999, floating point variable F000~F999.

Wiring Diagram:

Direct connect (crossover cable):

HMI RJ45 Male	Wire Color	PLC RJ45 Male
1 TX+	White/Orange	3 RX+
2 TX-	Orange	6 RX-
3 RX+	White/Green	1 TX+
4 BD4+	Blue	4 BD4+
5 BD4-	White/Blue	5 BD4-
6 RX-	Green	2 TX-
7 BD3+	White/Brown	7 BD3+
8 BD3-	Brown	8 BD3-



Through a hub:

HMI RJ45 Male	Wire Color	PLC RJ45 Male
1 TX+	White/Orange	1 TX+
2 TX-	Orange	2 TX-
3 RX+	White/Green	3 RX+
4 BD4+	Blue	4 BD4+
5 BD4-	White/Blue	5 BD4-
6 RX-	Green	6 RX-
7 BD3+	White/Brown	7 BD3+
8 BD3-	Brown	8 BD3-



Driver Version:

Version	Date	Description
V1.10	Mar/29/2010	

YOKOGAWA FA-M3

Supported Series : FA-M3 CPU SP35-5N, SP55-5N CPU port, F3LC11 Computer Link module.

Website : <http://www.yokogawa.com/itc/itc-index-en.htm>

HMI Setting:

Parameters	Recommended	Options	Notes
PLC type	YOKOGAWA FA-M3		
PLC I/F	RS232		
Baud rate	19200	9600, 19200	
Data bits	8	8	
Parity	Even	Even, Odd, None	
Stop bits	1	1	
PLC sta. no.	1	1-31	

PLC Setting:

Communication mode	Use Personal Communication Link Use checksum Use End Character
--------------------	--

WideField communication setting:

For WideField communication setting, select [Tool]/ [Set Environment], the default is [Automatic]. Using the Automatic Recognition, WideField software will connect the current PLC and get the PLC communication setting. If the PLC communication configuration is already known, select the [Fixed] mode, It will connect with the PLC quickly.

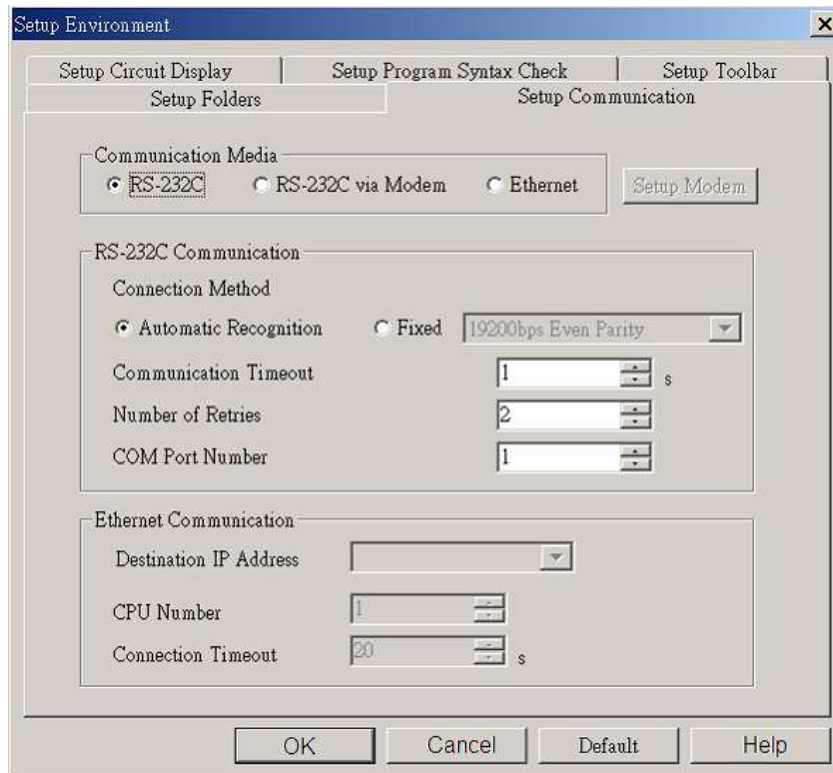

P.S Since Personal Computer link is used, when connecting to PLC it will delay about 20sec for testing communication.

YOKOGAWA PLC Communcation Setting:

YOKOGAWA FA-M3

CPU SP55-5N (same SP35-5N)

[File] / [New Project] to create a new project.

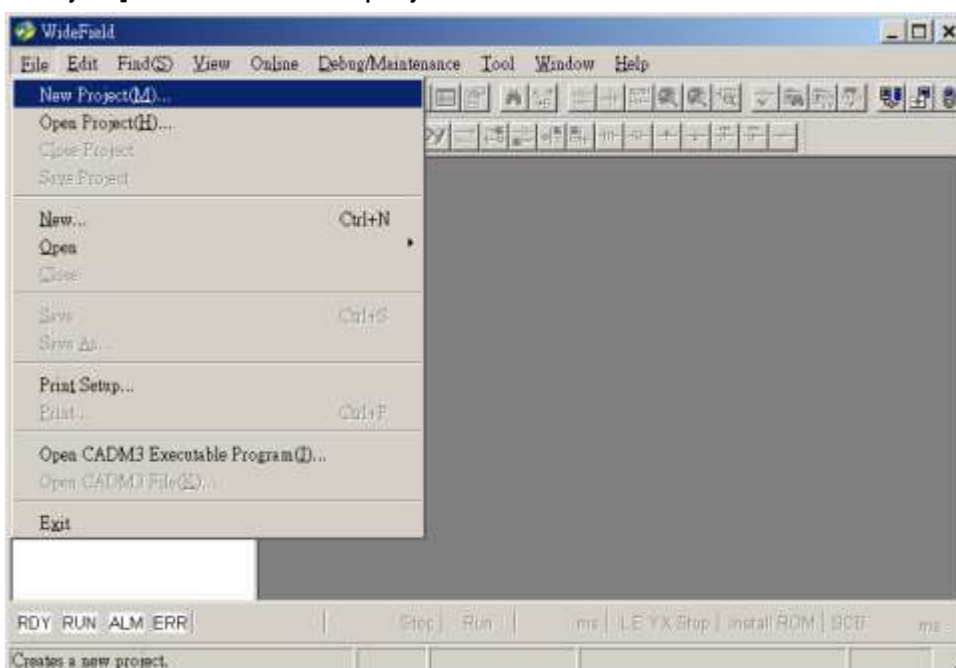

Click [Configuration] to set up communication.

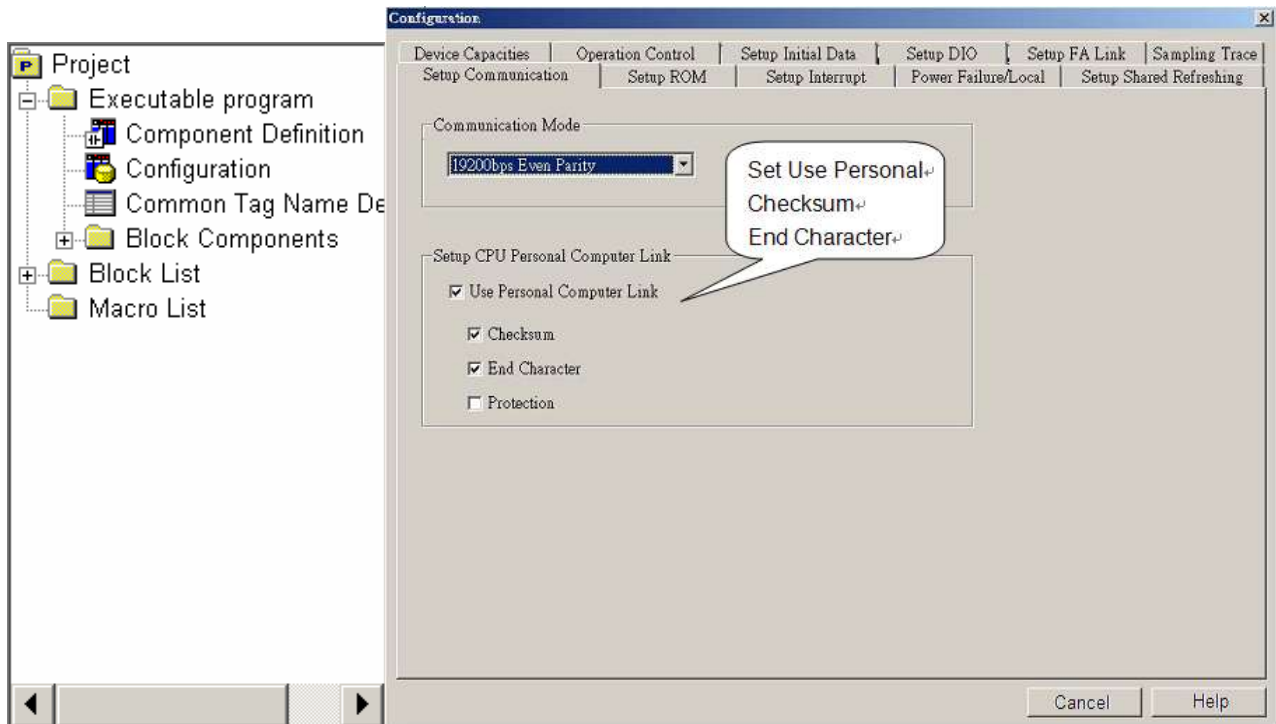

Device Address:



Bit/Word	Device type	Format	Range	Memo
B	X	DDDDD	0 ~ 71664	
B	Y	DDDDD	0 ~ 71664	
B	I	DDDDD	1 ~ 16384	
B	M	DDDD	1 ~ 9984	
B	L	DDDDD	0 ~ 78192	
W	D	DDDDD	1 ~ 16384	
W	B	DDDDD	1 ~ 32768	
W	V	DDD	1 ~ 256	
W	W	DDDDD	1 ~ 71024	
W	Z	DDDD	1 ~ 1024	

Wiring Diagram:





The following represents the view of HMI & PLC.

9P D-Sub to 9P D-Sub: Cable KM11



eMT3000 series

COM1 RS232 9P D-Sub Female	COM3 RS232 9P D-Sub Female		RS232 9P D-Sub Male
2 RX	8 RX		2 TXD
3 TX	7 TX		3 RXD
5 GND	5 GND		5 GND
			

MT6000/8000 series except MT6050i/MT8050i

COM1 RS232 9P D-Sub Female	COM2 RS232 9P D-Sub Female	COM3 RS232 9P D-Sub Male	RS232 9P D-Sub Male
2 RX	6 RX	8 RX	2 TXD
3 TX	4 TX	7 TX	3 RXD
5 GND	5 GND	5 GND	5 GND
			



MT6050i/MT8050i

COM1 RS232 9P D-Sub Female			RS232 9P D-Sub Male
9 RX			2 TXD
6 TX			3 RXD
5 GND			5 GND
			





The following represents the view of HMI & PLC.

9P D-Sub to 9P D-Sub: LC11



eMT3000 series

COM1 RS232 9P D-Sub Female	COM3 RS232 9P D-Sub Female		RS232 9P D-Sub Male
2 RX	8 RX		3 TXD
3 TX	7 TX		2 RXD
5 GND	5 GND		5 GND
			7 RTS
			8 CTS
			circuit
			

MT6000/8000 series except MT6050i/MT8050i

COM1 RS232 9P D-Sub Female	COM2 RS232 9P D-Sub Female	COM3 RS232 9P D-Sub Male	RS232 9P D-Sub Male
2 RX	6 RX	8 RX	3 TXD
3 TX	4 TX	7 TX	2 RXD
5 GND	5 GND	5 GND	5 GND
			7 RTS
			8 CTS
			circuit
			

MT6050i/MT8050i

COM1 RS232 9P D-Sub Female			RS232 9P D-Sub Male
9 RX			3 TXD
6 TX			2 RXD
5 GND			5 GND
			7 RTS
			8 CTS
			circuit
			

Driver Version:

Version	Date	Description
V1.20	Oct/23/2009	
V1.30	May/31/2012	Extended address L range up to 78192.

YOKOGAWA FA-M3 (Ethernet)

Supported Series : FA-M3 CPU SP35-5N, SP55-5N with F3LE01-5T/F3LE11-0T Ethernet module.

Website: <http://www.yokogawa.com/itc/itc-index-en.htm>

HMI Setting:







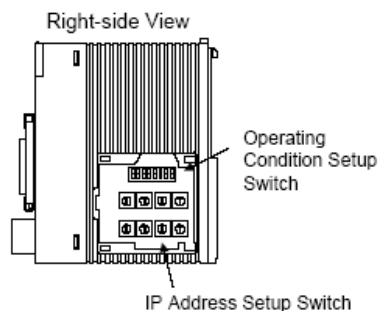

Parameters	Recommended	Options	Notes
PLC type	YOKOGAWA FA-M3 (Ethernet)		
PLC I/F	Ethernet		
Port no.	12289		
PLC sta. no.	1		

PLC Setting:

Communication mode	Set IP Address, and set all condition setup switch to OFF.
--------------------	--



Example: Setting the IP address to 192.168.250.210

				
				
Hexa decimal	C0	A8	FA	D2
Decimal	192	168	250	210

Device Address:

Bit/Word	Device type	Format	Range	Memo
B	X	DDDDD	0 ~ 71664	
B	Y	DDDDD	0 ~ 71664	
B	I	DDDDD	1 ~ 16384	
B	M	DDDD	1 ~ 9984	
B	L	DDDDD	0 ~ 78192	
W	D	DDDD	1 ~ 8192	
W	B	DDDDD	1 ~ 32768	
W	V	DD	1 ~ 64	
W	W	DDDDD	1 ~ 71024	
W	Z	DDD	1 ~ 512	

Wiring Diagram:

Direct connect (crossover cable):

HMI RJ45 Male	Wire Color	PLC RJ45 Male
1 TX+	White/Orange	3 RX+
2 TX-	Orange	6 RX-
3 RX+	White/Green	1 TX+
4 BD4+	Blue	4 BD4+
5 BD4-	White/Blue	5 BD4-
6 RX-	Green	2 TX-
7 BD3+	White/Brown	7 BD3+
8 BD3-	Brown	8 BD3-



Through a hub:

HMI RJ45 Male	Wire Color	PLC RJ45 Male
1 TX+	White/Orange	1 TX+
2 TX-	Orange	2 TX-
3 RX+	White/Green	3 RX+
4 BD4+	Blue	4 BD4+
5 BD4-	White/Blue	5 BD4-
6 RX-	Green	6 RX-
7 BD3+	White/Brown	7 BD3+
8 BD3-	Brown	8 BD3-



Driver Version:

Version	Date	Description
V1.00	Dec/30/2008	Driver released.
V1.10	May/31/2012	Extended address L range up to 78192.

YUDIAN AIBUS

Supported Series: YUDIAN Automation AI-501, AI-518, AI-519, AI-701, AI-702M, AI-704M, AI-706M, AI-719.

Website: <http://www.yudian.us>

HMI Setting:

Parameters	Recommended	Options	Notes
PLC type	AIBUS		
PLC I/F	RS485 2W	RS232	
Baud rate	9600	9600, 19200	
Data bits	8		
Parity	None		
Stop bits	2		
HMI sta. no.	0		
PLC sta. no.	1	0-100	

On-line simulation	YES	—
Extend address mode	NO	

Device Address:

AI-518

Bit/Word	Device type		Format	Range	Memo
W	0	00H	DD		SV/STEP
W	1	01H	DD	-1999 ~ 9999	HIAL
W	2	02H	DD	-1999 ~ 9999	LoAL
W	3	03H	DD	0 ~ 9999	dHAL
W	4	04H	DD	0 ~ 9999	dLAL
W	5	05H	DD	0 ~ 2000	dF
W	6	06H	DD	0 ~ 4	Ctrl
W	7	07H	DD	0 ~ 9999	M5
W	8	08H	DD	1 ~ 9999	P
W	9	09H	DD	0 ~ 2000	t

Bit/Word	Device type		Format	Range	Memo
W	10	0AH	DD	0 ~ 125	Ctl
W	11	0BH	DD	0 ~ 37	Sn (read only)
W	12	0CH	DD	0 ~ 3	dIP (read only)
W	13	0DH	DD	-1999 ~ 9999	dIL
W	14	0EH	DD	-1999 ~ 9999	dIH
W	15	0FH	DD	0 ~ 9999	ALP
W	16	10H	DD	-1999 ~ 4000 0.1°C	Sc
W	17	11H	DD	0 ~ 48	Op1
W	18	12H	DD	-110 ~ 110%	oPL
W	19	13H	DD	0 ~ 110%	oPH
W	20	14H	DD	0 ~ 127	CF (read only)
W	21	15H	DD	0 ~ 19.2K	Baud rate (bAud) /808Pstatus word: run: 0 suspend: 4 stop: 12 (read only)
W	22	16H	DD	0 ~ 100	ADDR
W	23	17H	DD	0 ~ 20	dL
W	24	18H	DD	0 ~ 127	Run
W	25	19H	DD	0 ~ 9999	Loc

AI-701



Bit/Word	Device type		Format	Range	Memo
W	1	01H	DD	-9990 ~ 30000	HIAL
W	2	02H	DD	-9990 ~ 30000	LoAL
W	3	03H	DD	-9990 ~ 30000	HdAL
W	4	04H	DD	-9990 ~ 30000	LdAL
W	5	05H	DD	0 ~ 2000	AHYS
W	11	0BH	DD	0 ~ 37	InP (read only)
W	12	0CH	DD	0 ~ 3	dPt
W	13	0DH	DD	-9999 ~ 30000	SCL
W	14	0EH	DD	-9999 ~ 30000	SCH
W	15	0FH	DD	0 ~ 4444	AOP
W	16	10H	DD	-1999 ~ 4000 0.1°C	Scb

Bit/Word	Device type		Format	Range	Memo
W	17	11H	DD	0 ~ 48	Opt
W	21	15H	DD	0 ~ 19.2K	Baud rate (bAud) /808P status word run: 0 suspend: 4 stop: 12 (read only)
W	22	16H	DD	0 ~ 80	ADDR
W	23	17H	DD	0 ~ 40	FILt
W	25	19H	DD	0 ~ 255	Loc



Wiring Diagram:

The following represents the view of HMI & PLC.



eMT3000 series

COM1 RS485 2W 9P D-Sub Male	COM3 RS485 2W 9P D-Sub Male		RS485 2W terminal
1 RX-	6 Data-		4 COMM A
2 RX+	9 Data+		3 COMM B
5 GND	5 GND		
			

MT6000/8000 series except MT6050i/MT8050i

COM1 RS485 2W 9P D-Sub Male	COM3 RS485 2W 9P D-Sub Male		RS485 2W terminal
1 RX-	6 Data-		4 COMM A
2 RX+	9 Data+		3 COMM B
5 GND	5 GND		
			

MT6050i/MT8050i

COM1 RS485 2W 9P D-Sub Female	COM3 RS485 2W 9P D-Sub Female		RS485 2W terminal
1 RX-	7 Data-		4 COMM A
2 RX+	8 Data+		3 COMM B
5 GND	5 GND		
			

Driver Version:

Version	Date	Description
V1.20	Dec/30/2008	

MT6050i/MT8050i Com Port Pin Assignment

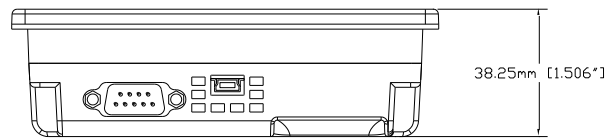

Bottom View

MT6050i/MT8050i

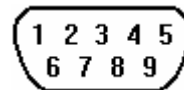

Pin assignment of the 9 Pin, Male,

Pin assignment of the 9 Pin, Male, SUB-D, COM1 [RS-232]/ [RS-485], COM3 [RS-485] Port. Only Com1[RS485 2W] support MPI 187.5K.

Pin#	Symbol	Com1[RS485]		Com1[RS232]	Com3[RS485]
		4 wire	2 wire		
1	Rx-	Rx-	Data-	—	
2	Rx+	Rx+	Data+		
3	Tx-	Tx-			
4	Tx+	Tx+			
5	GND	GND			
6	TxD			Transmit	
7	Data-				Data-
8	Data+				Data+
9	RxD			Receive	

Wiring Diagram:

MT6050i COM1 [RS-232]

9P D-SUB Female

9	RXD
6	TXD
5	GND

PLC RS-232

Communication Com Port interface

TXD
RXD
GND

MT6050i COM1 [RS-485 2w]

9P D-SUB Female

1	Data-
2	Data+

PLC RS-485 2w

Communication Com Port interface

Data-
Data+

MT6050i COM3* [RS-485 2w]

9P D-SUB Female

7	Data-
8	Data+

PLC RS-485 2w

Communication Com Port interface

Data-
Data+

*RS485 2W COM3 is only available for MT6050iv2

MT6050i COM1 [RS-485 4w]

9P D-SUB Female

1	RX-
2	RX
3	TX-
4	TX+

PLC RS-485 2w

Communication Com Port interface

TX-
TX+
RX-
RX+