

Typical Applications

The HMC479MP86 / HMC479MP86E is an ideal RF/IF gain block & LO or PA driver:

- Cellular / PCS / 3G
- Fixed Wireless & WLAN
- CATV, Cable Modem & DBS
- Microwave Radio & Test Equipment

Functional Diagram

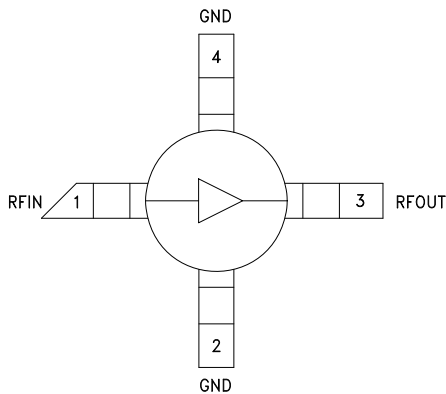

Features

- P1dB Output Power: +18 dBm
- Gain: 15 dB
- Output IP3: +34 dBm
- Cascadable 50 Ohm I/Os
- Single Supply: +5V to +12V
- Included in the HMC-DK001 Designer's Kit

General Description

The HMC479MP86 & HMC479MP86E are SiGe Heterojunction Bipolar Transistor (HBT) Gain Block MMIC SMT amplifiers covering DC to 5 GHz. This Micro-P packaged amplifier can be used as a cascadable 50 Ohm RF/IF gain stage as well as a LO or PA driver with up to +21 dBm output power. The HMC479MP86(E) offers 15 dB of gain with a +34 dBm output IP3 at 850 MHz while requiring only 72 mA from a single positive supply. The Darlington feedback pair used results in reduced sensitivity to normal process variations and excellent gain stability over temperature while requiring a minimal number of external bias components.

Electrical Specifications, $V_s = 8.0\text{ V}$, $R_{bias} = 51\text{ Ohm}$, $T_A = +25^\circ\text{ C}$

| Parameter | | Min. | Typ. | Max. | Units |
|---|---------------|------|-------|-------|--------|
| Gain | DC - 1.0 GHz | 12.5 | 14.5 | | dB |
| | 1.0 - 2.0 GHz | 11.5 | 13 | | dB |
| | 2.0 - 3.0 GHz | 10.5 | 12 | | dB |
| | 3.0 - 4.0 GHz | 9 | 11 | | dB |
| | 4.0 - 5.0 GHz | 7.5 | 9.5 | | dB |
| Gain Variation Over Temperature | DC - 5 GHz | | 0.008 | 0.012 | dB/ °C |
| Input Return Loss | DC - 1.0 GHz | | 12 | | dB |
| | 1.0 - 2.0 GHz | | 16 | | dB |
| | 2.0 - 4.0 GHz | | 18 | | dB |
| | 4.0 - 5.0 GHz | | 15 | | dB |
| Output Return Loss | DC - 1.0 GHz | | 18 | | dB |
| | 1.0 - 3.5 GHz | | 25 | | dB |
| | 3.5 - 5.0 GHz | | 15 | | dB |
| Reverse Isolation | DC - 5 GHz | | 18 | | dB |
| Output Power for 1 dB Compression (P1dB) | 0.5 - 1.0 GHz | 16 | 18.5 | | dBm |
| | 1.0 - 2.5 GHz | 13 | 17 | | dBm |
| | 2.5 - 4.0 GHz | 11 | 14 | | dBm |
| | 4.0 - 5.0 GHz | 9 | 12 | | dBm |
| Output Third Order Intercept (IP3) (Pout= 0 dBm per tone, 1 MHz spacing) | 0.5 - 1.0 GHz | | 34 | | dBm |
| | 1.0 - 2.5 GHz | | 32 | | dBm |
| | 2.5 - 4.0 GHz | | 28 | | dBm |
| | 4.0 - 5.0 GHz | | 25 | | dBm |
| Noise Figure | DC - 2.0 GHz | | 4.0 | | dB |
| | 2.0 - 5.0 GHz | | 4.8 | | dB |
| Supply Current (Icq) | | | 72 | 100 | mA |

Note: Data taken with broadband bias tee on device output.

For price, delivery and to place orders: Hittite Microwave Corporation, 20 Alpha Road, Chelmsford, MA 01824

Phone: 978-250-3343 Fax: 978-250-3373 Order On-line at www.hittite.com

Application Support: Phone: 978-250-3343 or apps@hittite.com

Broadband Gain & Return Loss

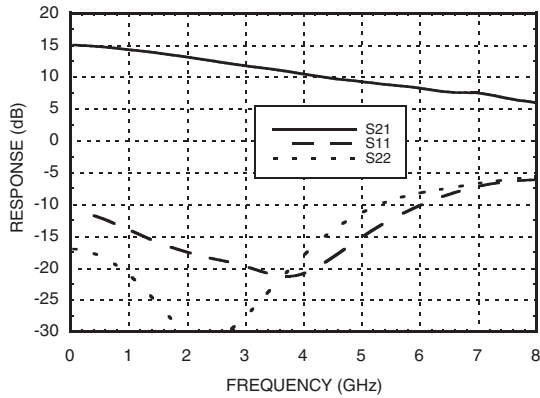

Gain vs. Temperature

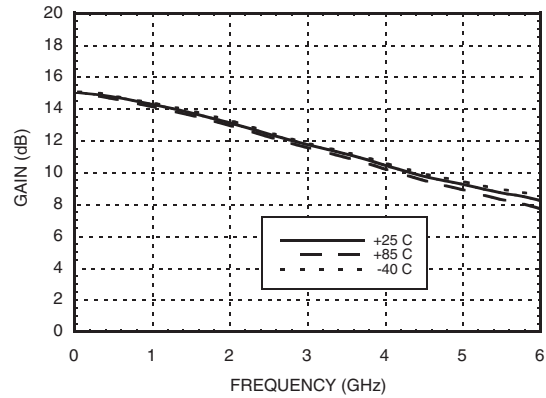

Input Return Loss vs. Temperature

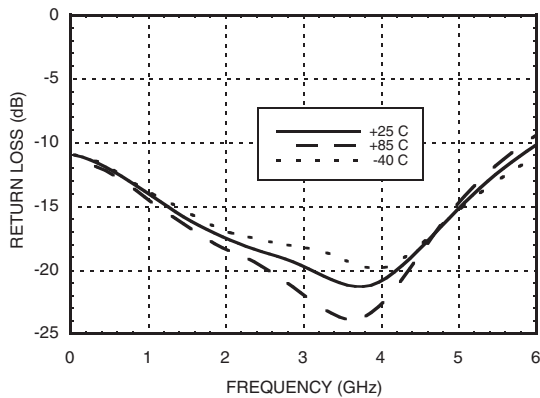

Output Return Loss vs. Temperature

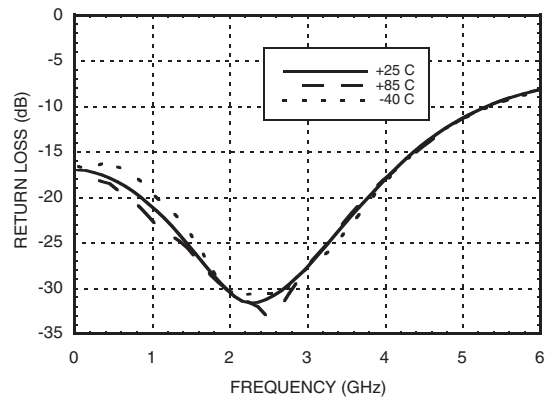

Reverse Isolation vs. Temperature

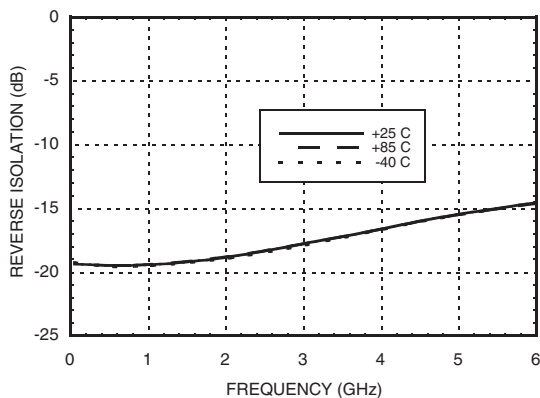

Noise Figure vs. Temperature

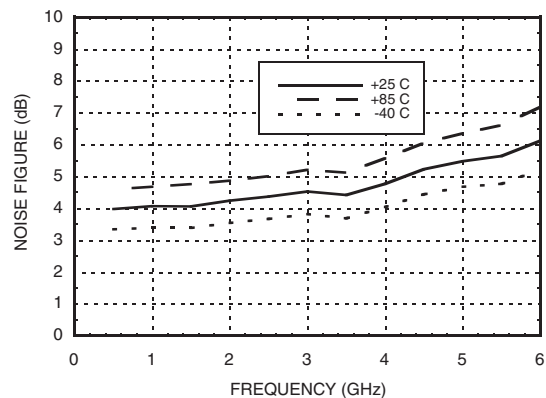

P1dB vs. Temperature

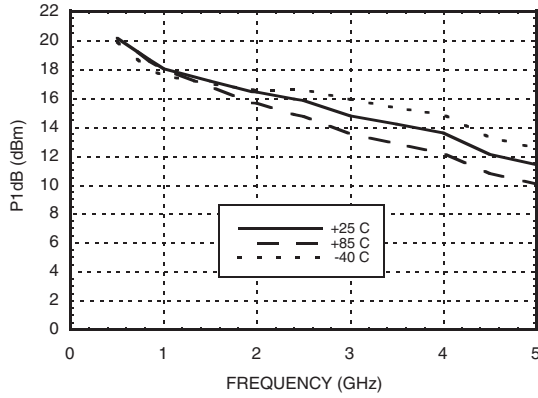

Psat vs. Temperature

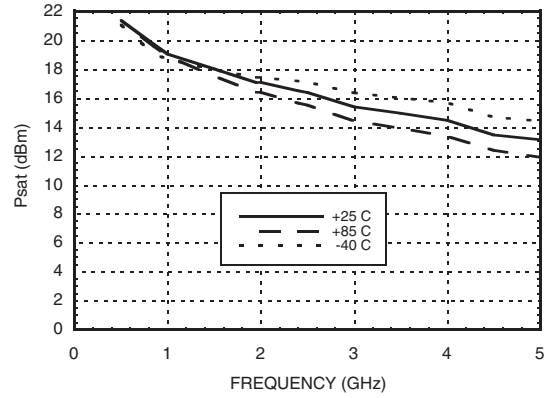

Output IP3 vs. Temperature

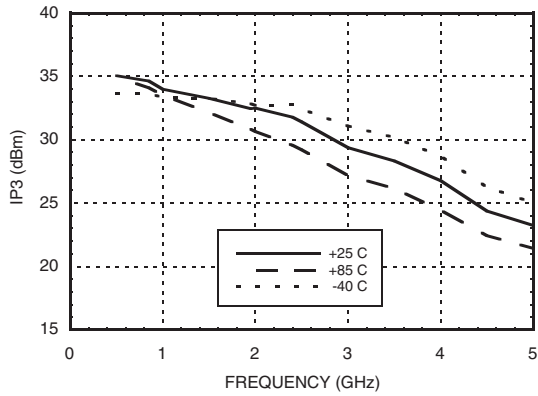

Gain, Power & OIP3 vs. Supply Voltage for Constant Icc= 72 mA @ 850 MHz

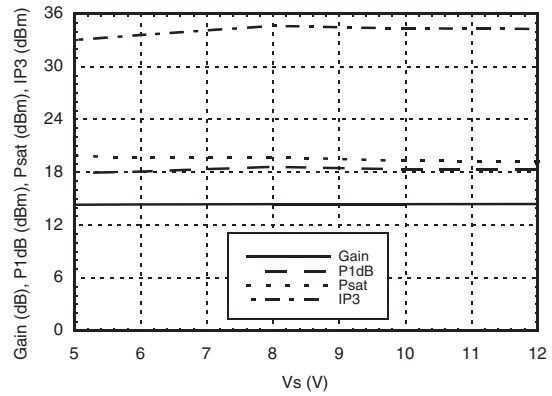

Vcc vs. Icc Over Temperature for Fixed Vs= 8V, RBIAS= 51 Ohms

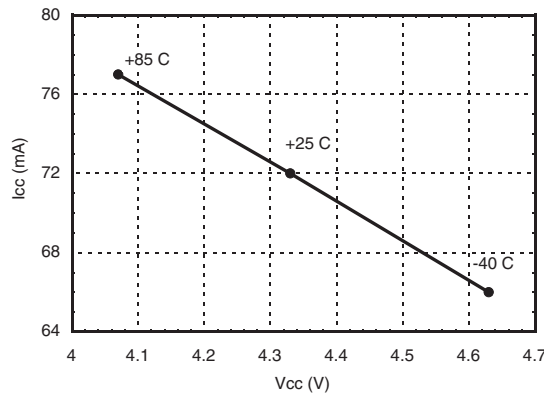

Absolute Maximum Ratings

| | |
|---|----------------|
| Collector Bias Voltage (Vcc) | +6 Vdc |
| Collector Bias Current (Icc) | 100 mA |
| RF Input Power (RFIN)(Vcc = +4.3 Vdc) | +17 dBm |
| Junction Temperature | 150 °C |
| Continuous Pdiss (T = 85 °C) (derate 10.8 mW/°C above 85 °C) | 0.702 W |
| Thermal Resistance (junction to lead) | 92.6 °C/W |
| Storage Temperature | -65 to +150 °C |
| Operating Temperature | -40 to +85 °C |



ELECTROSTATIC SENSITIVE DEVICE
OBSERVE HANDLING PRECAUTIONS

Outline Drawing

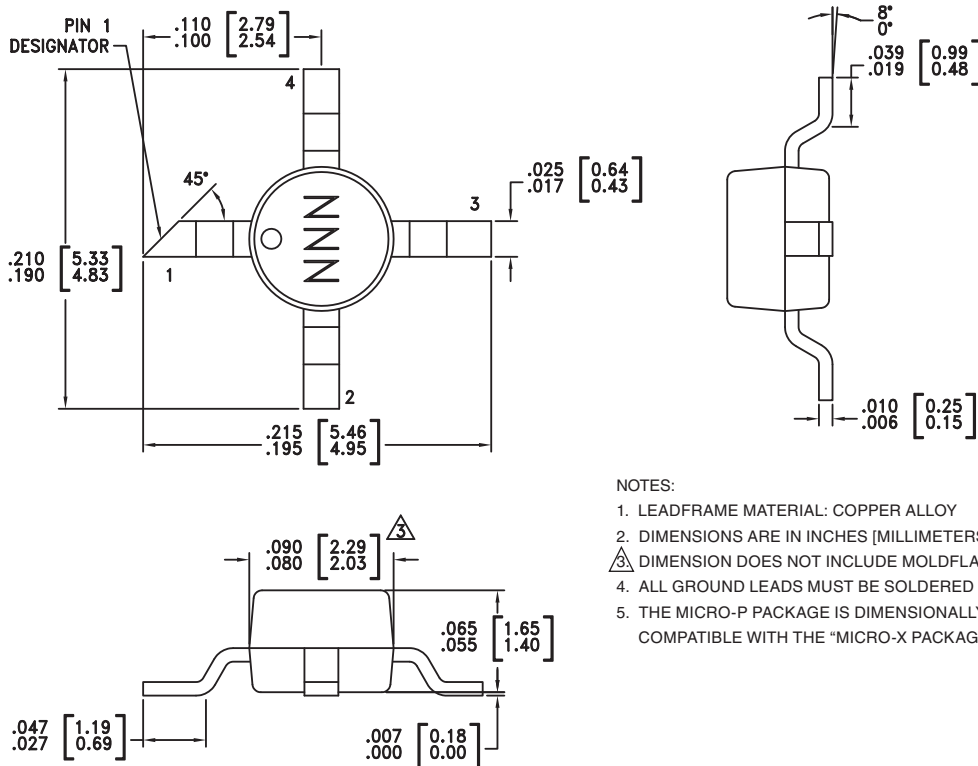

- NOTES:
- LEADFRAME MATERIAL: COPPER ALLOY
 - DIMENSIONS ARE IN INCHES [MILLIMETERS]
 -  DIMENSION DOES NOT INCLUDE MOLDFLASH OF 0.15mm PER SIDE.
 - ALL GROUND LEADS MUST BE SOLDERED TO PCB RF GROUND.
 - THE MICRO-P PACKAGE IS DIMENSIONALLY COMPATIBLE WITH THE "MICRO-X PACKAGE"

Package Information

| Part Number | Package Body Material | Lead Finish | MSL Rating | Package Marking |
|-------------|--|---------------|---------------------|-----------------|
| HMC479MP86 | Low Stress Injection Molded Plastic | Sn/Pb Solder | MSL1 ^[1] | 479 |
| HMC479MP86E | RoHS-compliant Low Stress Injection Molded Plastic | 100% matte Sn | MSL1 ^[2] | <u>479</u> |

[1] Max peak reflow temperature of 235 °C
[2] Max peak reflow temperature of 260 °C

Pin Descriptions

| Pin Number | Function | Description | Interface Schematic |
|------------|----------|---|---------------------|
| 1 | RFIN | This pin is DC coupled. An off chip DC blocking capacitor is required. | |
| 3 | RFOUT | RF output and DC Bias (Vcc) for the output stage. | |
| 2, 4 | GND | These pins must be connected to RF/DC ground. | |

Application Circuit

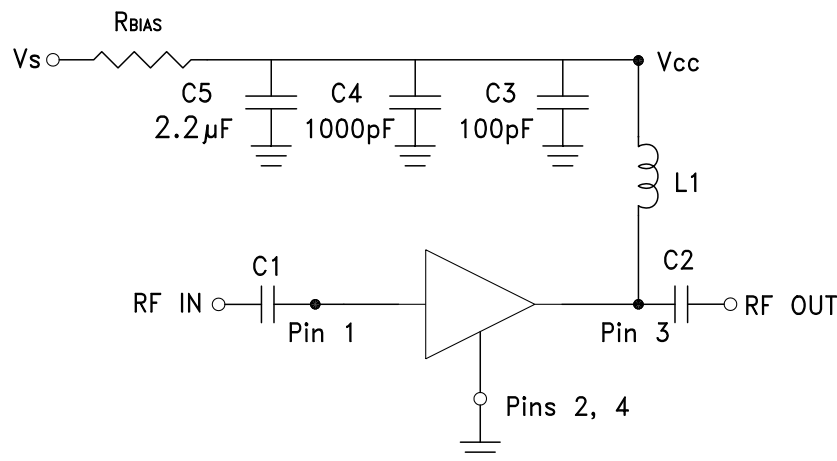

Recommended Bias Resistor Values for $I_{cc} = 72 \text{ mA}$, $R_{bias} = (V_s - V_{cc}) / I_{cc}$

| Supply Voltage (Vs) | 5V | 6V | 8V | 10V | 12V |
|---------------------|-------|-------|-------|-------|-------|
| RBIAS VALUE | 13 Ω | 27 Ω | 51 Ω | 82 Ω | 110 Ω |
| RBIAS POWER RATING | 1/8 W | 1/4 W | 1/2 W | 1/2 W | 1 W |

Note:

- External blocking capacitors are required on RFIN and RFOUT.
- RBIAS provides DC bias stability over temperature.

Recommended Component Values for Key Application Frequencies

| Component | Frequency (MHz) | | | | | | |
|-----------|-----------------|--------|--------|--------|--------|--------|--------|
| | 50 | 900 | 1900 | 2200 | 2400 | 3500 | 5000 |
| L1 | 270 nH | 56 nH | 18 nH | 18 nH | 15 nH | 8.2 nH | 6.8 nH |
| C1, C2 | 0.01 μF | 100 pF | 100 pF | 100 pF | 100 pF | 100 pF | 100 pF |

Evaluation PCB

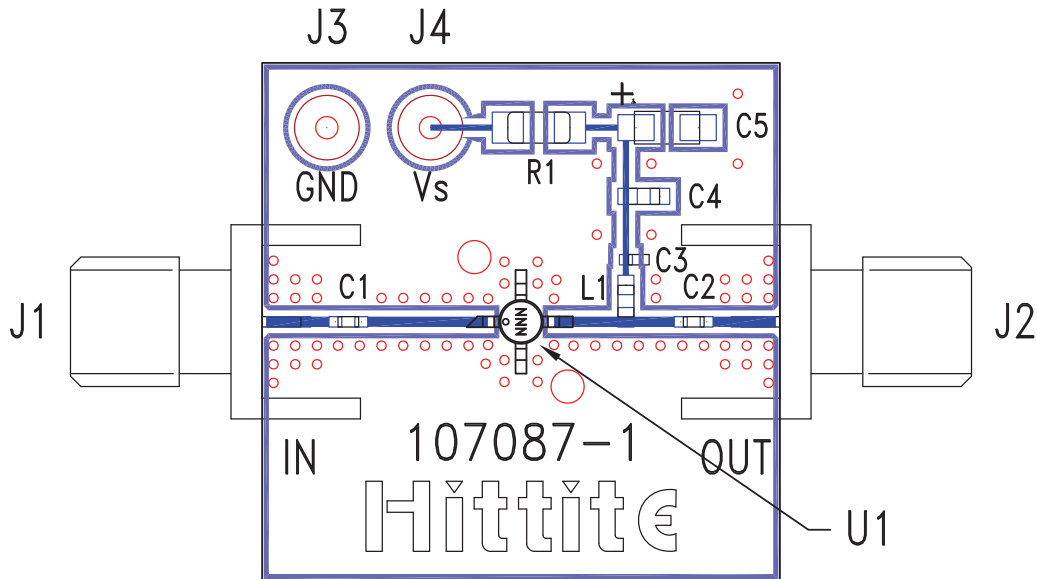

List of Materials for Evaluation PCB 107489 [1]

| Item | Description |
|---------|---------------------------------|
| J1 - J2 | PCB Mount SMA Connector |
| J3 - J4 | DC Pin |
| C1, C2 | Capacitor, 0402 Pkg. |
| C3 | 100 pF Capacitor, 0402 Pkg. |
| C4 | 1000 pF Capacitor, 0603 Pkg. |
| C5 | 2.2 μ F Capacitor, Tantalum |
| R1 | Resistor, 1210 Pkg. |
| L1 | Inductor, 0603 Pkg. |
| U1 | HMC479MP86 / HMC479MP86E |
| PCB [2] | 107087 Evaluation PCB |

[1] Reference this number when ordering complete evaluation PCB

[2] Circuit Board Material: Rogers 4350

The circuit board used in the application should use RF circuit design techniques. Signal lines should have 50 Ohm impedance while the package ground leads should be connected directly to the ground plane similar to that shown. A sufficient number of via holes should be used to connect the top and bottom ground planes. The evaluation board should be mounted to an appropriate heat sink. The evaluation circuit board shown is available from Hittite upon request.