

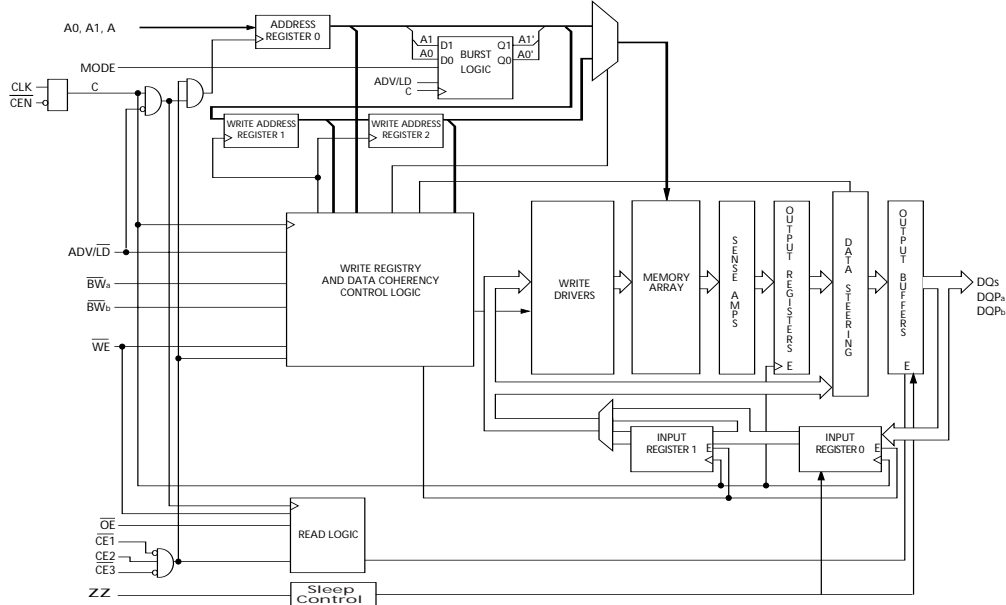
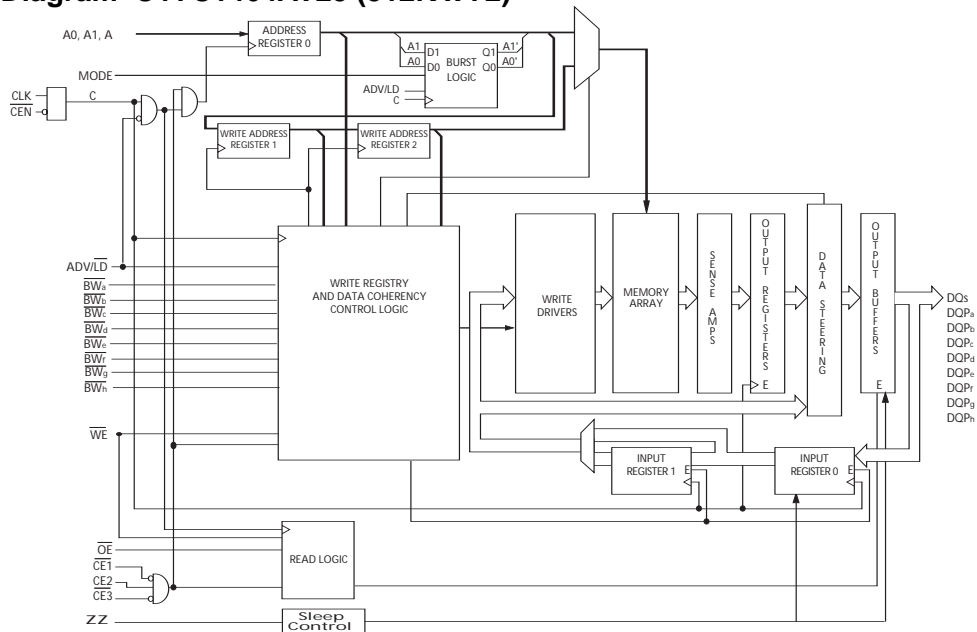

**Logic Block Diagram—CY7C1462AV25 (2 Mbit x 18)**

**Logic Block Diagram—CY7C1464AV25 (512K x 72)**

**Selection Guide**

	CY7C1460AV25-250 CY7C1462AV25-250 CY7C1464AV25-250	CY7C1460AV25-200 CY7C1462AV25-200 CY7C1464AV25-200	CY7C1460AV25-167 CY7C1462AV25-167 CY7C1464AV25-167	Unit
Maximum Access Time	2.6	3.2	3.4	ns
Maximum Operating Current	435	385	335	mA
Maximum CMOS Standby Current	100	100	100	mA

Shaded areas contain advance information. Please contact your local Cypress sales representative for availability of these parts.



**PRELIMINARY**

**CY7C1460AV25  
CY7C1462AV25  
CY7C1464AV25**

**Pin Configurations**

**100-pin TQFP Packages**

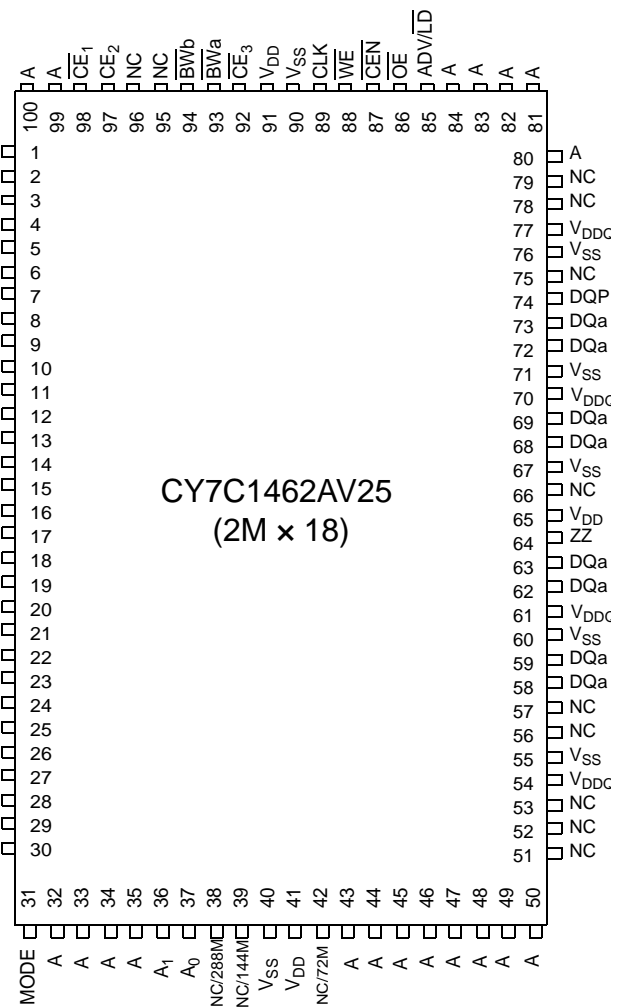
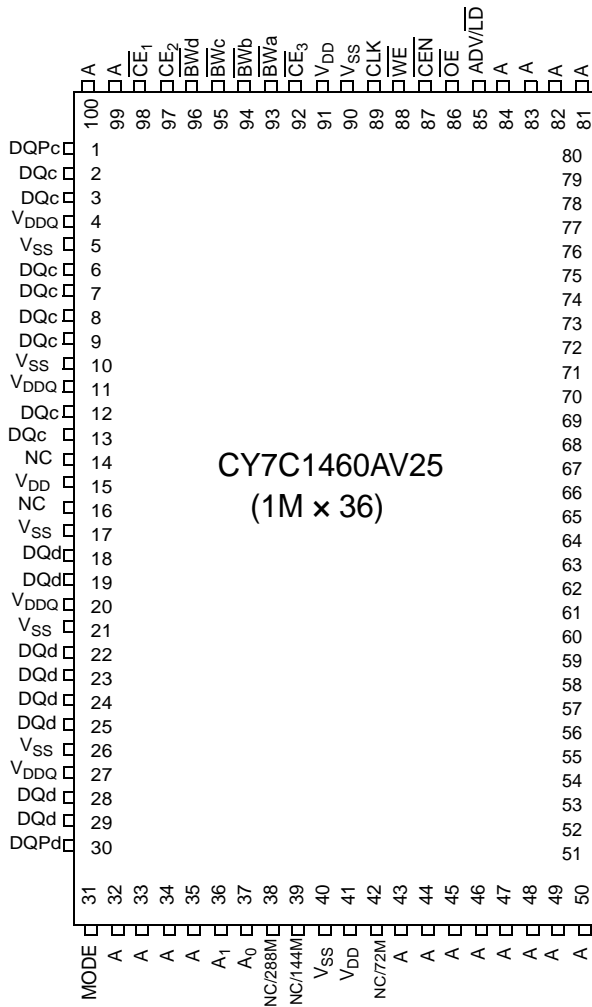



**Pin Configurations** (continued)

**165-Ball fBGA Pinout  
CY7C1460AV25 (1 Mbit x 36)**

	1	2	3	4	5	6	7	8	9	10	11
<b>A</b>	NC/288M	A	$\overline{CE}_1$	$\overline{BW}_c$	$\overline{BW}_b$	$\overline{CE}_3$	$\overline{CEN}$	ADV/LD	A	A	NC
<b>B</b>	NC	A	CE2	$\overline{BW}_d$	$\overline{BW}_a$	CLK	$\overline{WE}$	$\overline{OE}$	A	A	NC/144M
<b>C</b>	DQP <sub>c</sub>	NC	V <sub>DDQ</sub>	V <sub>SS</sub>	V <sub>SS</sub>	V <sub>SS</sub>	V <sub>SS</sub>	V <sub>SS</sub>	V <sub>DDQ</sub>	NC	DQP <sub>b</sub>
<b>D</b>	DQ <sub>c</sub>	DQ <sub>c</sub>	V <sub>DDQ</sub>	V <sub>DD</sub>	V <sub>SS</sub>	V <sub>SS</sub>	V <sub>SS</sub>	V <sub>DD</sub>	V <sub>DDQ</sub>	DQ <sub>b</sub>	DQ <sub>b</sub>
<b>E</b>	DQ <sub>c</sub>	DQ <sub>c</sub>	V <sub>DDQ</sub>	V <sub>DD</sub>	V <sub>SS</sub>	V <sub>SS</sub>	V <sub>SS</sub>	V <sub>DD</sub>	V <sub>DDQ</sub>	DQ <sub>b</sub>	DQ <sub>b</sub>
<b>F</b>	DQ <sub>c</sub>	DQ <sub>c</sub>	V <sub>DDQ</sub>	V <sub>DD</sub>	V <sub>SS</sub>	V <sub>SS</sub>	V <sub>SS</sub>	V <sub>DD</sub>	V <sub>DDQ</sub>	DQ <sub>b</sub>	DQ <sub>b</sub>
<b>G</b>	DQ <sub>c</sub>	DQ <sub>c</sub>	V <sub>DDQ</sub>	V <sub>DD</sub>	V <sub>SS</sub>	V <sub>SS</sub>	V <sub>SS</sub>	V <sub>DD</sub>	V <sub>DDQ</sub>	DQ <sub>b</sub>	DQ <sub>b</sub>
<b>H</b>	NC	NC	NC	V <sub>DD</sub>	V <sub>SS</sub>	V <sub>SS</sub>	V <sub>SS</sub>	V <sub>DD</sub>	NC	NC	ZZ
<b>J</b>	DQ <sub>d</sub>	DQ <sub>d</sub>	V <sub>DDQ</sub>	V <sub>DD</sub>	V <sub>SS</sub>	V <sub>SS</sub>	V <sub>SS</sub>	V <sub>DD</sub>	V <sub>DDQ</sub>	DQ <sub>a</sub>	DQ <sub>a</sub>
<b>K</b>	DQ <sub>d</sub>	DQ <sub>d</sub>	V <sub>DDQ</sub>	V <sub>DD</sub>	V <sub>SS</sub>	V <sub>SS</sub>	V <sub>SS</sub>	V <sub>DD</sub>	V <sub>DDQ</sub>	DQ <sub>a</sub>	DQ <sub>a</sub>
<b>L</b>	DQ <sub>d</sub>	DQ <sub>d</sub>	V <sub>DDQ</sub>	V <sub>DD</sub>	V <sub>SS</sub>	V <sub>SS</sub>	V <sub>SS</sub>	V <sub>DD</sub>	V <sub>DDQ</sub>	DQ <sub>a</sub>	DQ <sub>a</sub>
<b>M</b>	DQ <sub>d</sub>	DQ <sub>d</sub>	V <sub>DDQ</sub>	V <sub>DD</sub>	V <sub>SS</sub>	V <sub>SS</sub>	V <sub>SS</sub>	V <sub>DD</sub>	V <sub>DDQ</sub>	DQ <sub>a</sub>	DQ <sub>a</sub>
<b>N</b>	DQP <sub>d</sub>	NC	V <sub>DDQ</sub>	V <sub>SS</sub>	NC	NC	NC	V <sub>SS</sub>	V <sub>DDQ</sub>	NC	DQP <sub>a</sub>
<b>P</b>	NC	NC/72M	A	A	TDI	A1	TDO	A	A	A	NC
<b>R</b>	MODE	A	A	A	TMS	A0	TCK	A	A	A	A

**CY7C1462AV25 (2 Mbit x 18)**

	1	2	3	4	5	6	7	8	9	10	11
<b>A</b>	NC/288M	A	$\overline{CE}_1$	$\overline{BW}_b$	NC	$\overline{CE}_3$	$\overline{CEN}$	ADV/LD	A	A	A
<b>B</b>	NC	A	CE2	NC	$\overline{BW}_a$	CLK	$\overline{WE}$	$\overline{OE}$	A	A	NC/144M
<b>C</b>	NC	NC	V <sub>DDQ</sub>	V <sub>SS</sub>	V <sub>SS</sub>	V <sub>SS</sub>	V <sub>SS</sub>	V <sub>SS</sub>	V <sub>DDQ</sub>	NC	DQP <sub>a</sub>
<b>D</b>	NC	DQ <sub>b</sub>	V <sub>DDQ</sub>	V <sub>DD</sub>	V <sub>SS</sub>	V <sub>SS</sub>	V <sub>SS</sub>	V <sub>DD</sub>	V <sub>DDQ</sub>	NC	DQ <sub>a</sub>
<b>E</b>	NC	DQ <sub>b</sub>	V <sub>DDQ</sub>	V <sub>DD</sub>	V <sub>SS</sub>	V <sub>SS</sub>	V <sub>SS</sub>	V <sub>DD</sub>	V <sub>DDQ</sub>	NC	DQ <sub>a</sub>
<b>F</b>	NC	DQ <sub>b</sub>	V <sub>DDQ</sub>	V <sub>DD</sub>	V <sub>SS</sub>	V <sub>SS</sub>	V <sub>SS</sub>	V <sub>DD</sub>	V <sub>DDQ</sub>	NC	DQ <sub>a</sub>
<b>G</b>	NC	DQ <sub>b</sub>	V <sub>DDQ</sub>	V <sub>DD</sub>	V <sub>SS</sub>	V <sub>SS</sub>	V <sub>SS</sub>	V <sub>DD</sub>	V <sub>DDQ</sub>	NC	DQ <sub>a</sub>
<b>H</b>	NC	NC	NC	V <sub>DD</sub>	V <sub>SS</sub>	V <sub>SS</sub>	V <sub>SS</sub>	V <sub>DD</sub>	NC	NC	ZZ
<b>J</b>	DQ <sub>b</sub>	NC	V <sub>DDQ</sub>	V <sub>DD</sub>	V <sub>SS</sub>	V <sub>SS</sub>	V <sub>SS</sub>	V <sub>DD</sub>	V <sub>DDQ</sub>	DQ <sub>a</sub>	NC
<b>K</b>	DQ <sub>b</sub>	NC	V <sub>DDQ</sub>	V <sub>DD</sub>	V <sub>SS</sub>	V <sub>SS</sub>	V <sub>SS</sub>	V <sub>DD</sub>	V <sub>DDQ</sub>	DQ <sub>a</sub>	NC
<b>L</b>	DQ <sub>b</sub>	NC	V <sub>DDQ</sub>	V <sub>DD</sub>	V <sub>SS</sub>	V <sub>SS</sub>	V <sub>SS</sub>	V <sub>DD</sub>	V <sub>DDQ</sub>	DQ <sub>a</sub>	NC
<b>M</b>	DQ <sub>b</sub>	NC	V <sub>DDQ</sub>	V <sub>DD</sub>	V <sub>SS</sub>	V <sub>SS</sub>	V <sub>SS</sub>	V <sub>DD</sub>	V <sub>DDQ</sub>	DQ <sub>a</sub>	NC
<b>N</b>	DQP <sub>b</sub>	NC	V <sub>DDQ</sub>	V <sub>SS</sub>	NC	NC	NC	V <sub>SS</sub>	V <sub>DDQ</sub>	NC	NC
<b>P</b>	NC	NC/72M	A	A	TDI	A1	TDO	A	A	A	NC
<b>R</b>	MODE	A	A	A	TMS	A0	TCK	A	A	A	A

**Pin Configurations** (continued)

**209-Ball PBGA  
CY7C1464AV25 (512K x 72)**

	1	2	3	4	5	6	7	8	9	10	11
<b>A</b>	DQg	DQg	A	CE <sub>2</sub>	A	ADV/LD	A	$\overline{CE}_3$	A	DQb	DQb
<b>B</b>	DQg	DQg	$\overline{BWS}_c$	$\overline{BWS}_g$	NC	$\overline{WE}$	A	$\overline{BWS}_b$	$\overline{BWS}_f$	DQb	DQb
<b>C</b>	DQg	DQg	$\overline{BWS}_h$	$\overline{BWS}_d$	NC	$\overline{CE}_1$	NC	$\overline{BWS}_e$	$\overline{BWS}_a$	DQb	DQb
<b>D</b>	DQg	DQg	V <sub>SS</sub>	NC	NC	$\overline{OE}$	NC	NC	V <sub>SS</sub>	DQb	DQb
<b>E</b>	DQPg	DQPc	V <sub>DDQ</sub>	V <sub>DDQ</sub>	V <sub>DD</sub>	V <sub>DD</sub>	V <sub>DD</sub>	V <sub>DDQ</sub>	V <sub>DDQ</sub>	DQPf	DQPb
<b>F</b>	DQc	DQc	V <sub>SS</sub>	V <sub>SS</sub>	V <sub>SS</sub>	NC	V <sub>SS</sub>	V <sub>SS</sub>	V <sub>SS</sub>	DQf	DQf
<b>G</b>	DQc	DQc	V <sub>DDQ</sub>	V <sub>DDQ</sub>	V <sub>DD</sub>	NC	V <sub>DD</sub>	V <sub>DDQ</sub>	V <sub>DDQ</sub>	DQf	DQf
<b>H</b>	DQc	DQc	V <sub>SS</sub>	V <sub>SS</sub>	V <sub>SS</sub>	NC	V <sub>SS</sub>	V <sub>SS</sub>	V <sub>SS</sub>	DQf	DQf
<b>J</b>	DQc	DQc	V <sub>DDQ</sub>	V <sub>DDQ</sub>	V <sub>DD</sub>	NC	V <sub>DD</sub>	V <sub>DDQ</sub>	V <sub>DDQ</sub>	DQf	DQf
<b>K</b>	NC	NC	CLK	NC	V <sub>SS</sub>	$\overline{CEN}$	V <sub>SS</sub>	NC	NC	NC	NC
<b>L</b>	DQh	DQh	V <sub>DDQ</sub>	V <sub>DDQ</sub>	V <sub>DD</sub>	NC	V <sub>DD</sub>	V <sub>DDQ</sub>	V <sub>DDQ</sub>	DQa	DQa
<b>M</b>	DQh	DQh	V <sub>SS</sub>	V <sub>SS</sub>	V <sub>SS</sub>	NC	V <sub>SS</sub>	V <sub>SS</sub>	V <sub>SS</sub>	DQa	DQa
<b>N</b>	DQh	DQh	V <sub>DDQ</sub>	V <sub>DDQ</sub>	V <sub>DD</sub>	NC	V <sub>DD</sub>	V <sub>DDQ</sub>	V <sub>DDQ</sub>	DQa	DQa
<b>P</b>	DQh	DQh	V <sub>SS</sub>	V <sub>SS</sub>	V <sub>SS</sub>	ZZ	V <sub>SS</sub>	V <sub>SS</sub>	V <sub>SS</sub>	DQa	DQa
<b>R</b>	DQPd	DQPd	V <sub>DDQ</sub>	V <sub>DDQ</sub>	V <sub>DD</sub>	V <sub>DD</sub>	V <sub>DD</sub>	V <sub>DDQ</sub>	V <sub>DDQ</sub>	DQPa	DQPd
<b>T</b>	DQd	DQd	V <sub>SS</sub>	NC	NC	MODE	NC	NC	V <sub>SS</sub>	DQe	DQe
<b>U</b>	DQd	DQd	NC	A	NC/72M	A	A	A	NC	DQe	DQe
<b>V</b>	DQd	DQd	A	A	A	A1	A	A	A	DQe	DQe
<b>W</b>	DQd	DQd	TMS	TDI	A	A0	A	TDO	TCK	DQe	DQe

**Pin Definitions**

Pin Name	I/O Type	Pin Description
A0 A1 A	Input-Synchronous	<b>Address Inputs used to select one of the address locations.</b> Sampled at the rising edge of the CLK.
$\overline{BW}_a$ $\overline{BW}_b$ $\overline{BW}_c$ $\overline{BW}_d$ $\overline{BW}_e$ $\overline{BW}_f$ $\overline{BW}_g$ $\overline{BW}_h$	Input-Synchronous	<b>Byte Write Select Inputs, active LOW.</b> Qualified with WE to conduct writes to the SRAM. Sampled on the rising edge of CLK. $\overline{BW}_a$ controls DQ <sub>a</sub> and DQP <sub>a</sub> , $\overline{BW}_b$ controls DQ <sub>b</sub> and DQP <sub>b</sub> , $\overline{BW}_c$ controls DQ <sub>c</sub> and DQP <sub>c</sub> , $\overline{BW}_d$ controls DQ <sub>d</sub> and DQP <sub>d</sub> , $\overline{BW}_e$ controls DQ <sub>e</sub> and DQP <sub>e</sub> , $\overline{BW}_f$ controls DQ <sub>f</sub> and DQP <sub>f</sub> , $\overline{BW}_g$ controls DQ <sub>g</sub> and DQP <sub>g</sub> , $\overline{BW}_h$ controls DQ <sub>h</sub> and DQP <sub>h</sub> .
WE	Input-Synchronous	<b>Write Enable Input, active LOW.</b> Sampled on the rising edge of CLK if CEN is active LOW. This signal must be asserted LOW to initiate a write sequence.
A0 A1 A	Input-Synchronous	<b>Address Inputs used to select one of the address locations.</b> Sampled at the rising edge of the CLK.

**Pin Definitions** (continued)

Pin Name	I/O Type	Pin Description
BW <sub>a</sub> BW <sub>b</sub> BW <sub>c</sub> BW <sub>d</sub> BW <sub>e</sub> BW <sub>f</sub> BW <sub>g</sub> BW <sub>h</sub>	Input-Synchronous	<b>Byte Write Select Inputs, active LOW.</b> Qualified with WE to conduct writes to the SRAM. Sampled on the rising edge of CLK. BW <sub>a</sub> controls DQ <sub>a</sub> and DQP <sub>a</sub> , BW <sub>b</sub> controls DQ <sub>b</sub> and DQP <sub>b</sub> , BW <sub>c</sub> controls DQ <sub>c</sub> and DQP <sub>c</sub> , BW <sub>d</sub> controls DQ <sub>d</sub> and DQP <sub>d</sub> , BW <sub>e</sub> controls DQ <sub>e</sub> and DQP <sub>e</sub> , BW <sub>f</sub> controls DQ <sub>f</sub> and DQP <sub>f</sub> , BW <sub>g</sub> controls DQ <sub>g</sub> and DQP <sub>g</sub> , BW <sub>h</sub> controls DQ <sub>h</sub> and DQP <sub>h</sub> .
WE	Input-Synchronous	<b>Write Enable Input, active LOW.</b> Sampled on the rising edge of CLK if CEN is active LOW. This signal must be asserted LOW to initiate a write sequence.
ADV/LD	Input-Synchronous	<b>Advance/Load Input used to advance the on-chip address counter or load a new address.</b> When HIGH (and CEN is asserted LOW) the internal burst counter is advanced. When LOW, a new address can be loaded into the device for an access. After being deselected, ADV/LD should be driven LOW in order to load a new address.
ADV/LD	Input-Synchronous	<b>Advance/Load Input used to advance the on-chip address counter or load a new address.</b> When HIGH (and CEN is asserted LOW) the internal burst counter is advanced. When LOW, a new address can be loaded into the device for an access. After being deselected, ADV/LD should be driven LOW in order to load a new address.
CLK	Input-Clock	<b>Clock Input.</b> Used to capture all synchronous inputs to the device. CLK is qualified with CEN. CLK is only recognized if CEN is active LOW.
CE <sub>1</sub>	Input-Synchronous	<b>Chip Enable 1 Input, active LOW.</b> Sampled on the rising edge of CLK. Used in conjunction with CE <sub>2</sub> and CE <sub>3</sub> to select/deselect the device.
CE <sub>2</sub>	Input-Synchronous	<b>Chip Enable 2 Input, active HIGH.</b> Sampled on the rising edge of CLK. Used in conjunction with CE <sub>1</sub> and CE <sub>3</sub> to select/deselect the device.
CE <sub>3</sub>	Input-Synchronous	<b>Chip Enable 3 Input, active LOW.</b> Sampled on the rising edge of CLK. Used in conjunction with CE <sub>1</sub> and CE <sub>2</sub> to select/deselect the device.
OE	Input-Asynchronous	<b>Output Enable, active LOW.</b> Combined with the synchronous logic block inside the device to control the direction of the I/O pins. When LOW, the I/O pins are allowed to behave as outputs. When deasserted HIGH, I/O pins are tri-stated, and act as input data pins. OE is masked during the data portion of a write sequence, during the first clock when emerging from a deselected state and when the device has been deselected.
CEN	Input-Synchronous	<b>Clock Enable Input, active LOW.</b> When asserted LOW the clock signal is recognized by the SRAM. When deasserted HIGH the clock signal is masked. Since deasserting CEN does not deselect the device, CEN can be used to extend the previous cycle when required.
DQ <sub>a</sub> DQ <sub>b</sub> DQ <sub>c</sub> DQ <sub>d</sub> DQ <sub>e</sub> DQ <sub>f</sub> DQ <sub>g</sub> DQ <sub>h</sub>	I/O-Synchronous	<b>Bidirectional Data I/O lines.</b> As inputs, they feed into an on-chip data register that is triggered by the rising edge of CLK. As outputs, they deliver the data contained in the memory location specified by A <sub>x</sub> during the previous clock rise of the read cycle. The direction of the pins is controlled by OE and the internal control logic. When OE is asserted LOW, the pins can behave as outputs. When HIGH, DQ <sub>a</sub> –DQ <sub>d</sub> are placed in a tri-state condition. The outputs are automatically tri-stated during the data portion of a write sequence, during the first clock when emerging from a deselected state, and when the device is deselected, regardless of the state of OE.
DQP <sub>a</sub> DQP <sub>b</sub> DQP <sub>c</sub> DQP <sub>d</sub> DQP <sub>e</sub> DQP <sub>f</sub> DQP <sub>g</sub> DQP <sub>h</sub>	I/O-Synchronous	<b>Bidirectional Data Parity I/O lines.</b> Functionally, these signals are identical to DQ <sub>[31:0]</sub> . During write sequences, DQP <sub>a</sub> is controlled by BW <sub>a</sub> , DQP <sub>b</sub> is controlled by BW <sub>b</sub> , DQP <sub>c</sub> is controlled by BW <sub>c</sub> , and DQP <sub>d</sub> is controlled by BW <sub>d</sub> , DQP <sub>e</sub> is controlled by BW <sub>e</sub> , DQP <sub>f</sub> is controlled by BW <sub>f</sub> , DQP <sub>g</sub> is controlled by BW <sub>g</sub> , DQP <sub>h</sub> is controlled by BW <sub>h</sub> .
MODE	Input Strap Pin	<b>Mode Input.</b> Selects the burst order of the device. Tied HIGH selects the interleaved burst order. Pulled LOW selects the linear burst order. MODE should not change states during operation. When left floating MODE will default HIGH, to an interleaved burst order.
TDO	JTAG serial output Synchronous	<b>Serial data-out to the JTAG circuit.</b> Delivers data on the negative edge of TCK.
TDI	JTAG serial input Synchronous	<b>Serial data-In to the JTAG circuit.</b> Sampled on the rising edge of TCK.



**Pin Definitions** (continued)

Pin Name	I/O Type	Pin Description
TMS	Test Mode Select Synchronous	<b>This pin controls the Test Access Port state machine.</b> Sampled on the rising edge of TCK.
TCK	JTAG-Clock	<b>Clock input to the JTAG circuitry.</b>
V <sub>DD</sub>	Power Supply	<b>Power supply inputs to the core of the device.</b>
V <sub>DDQ</sub>	I/O Power Supply	<b>Power supply for the I/O circuitry.</b>
V <sub>SS</sub>	Ground	<b>Ground for the device.</b> Should be connected to ground of the system.
NC	N/A	<b>No connects.</b> This pin is not connected to the die.
NC/72M	N/A	<b>Not connected to the die.</b> Can be tied to any voltage level.
NC/144M	N/A	<b>Not connected to the die.</b> Can be tied to any voltage level.
NC/288M	N/A	<b>Not connected to the die.</b> Can be tied to any voltage level.
ZZ	Input-Asynchronous	<b>ZZ “sleep” Input.</b> This active HIGH input places the device in a non-time critical “sleep” condition with data integrity preserved. During normal operation, this pin can be connected to V <sub>ss</sub> or left floating.

**Introduction**
**Functional Overview**

The CY7C1460AV25/CY7C1462AV25/CY7C1464AV25 are synchronous-pipelined Burst NoBL SRAMs designed specifically to eliminate wait states during Write/Read transitions. All synchronous inputs pass through input registers controlled by the rising edge of the clock. The clock signal is qualified with the Clock Enable input signal (CEN). If CEN is HIGH, the clock signal is not recognized and all internal states are maintained. All synchronous operations are qualified with CEN. All data outputs pass through output registers controlled by the rising edge of the clock. Maximum access delay from the clock rise ( $t_{CO}$ ) is 2.6 ns (250-MHz device).

Accesses can be initiated by asserting all three Chip Enables ( $\overline{CE}_1$ ,  $\overline{CE}_2$ ,  $\overline{CE}_3$ ) active at the rising edge of the clock. If Clock Enable (CEN) is active LOW and ADV/LD is asserted LOW, the address presented to the device will be latched. The access can either be a read or write operation, depending on the status of the Write Enable (WE).  $BW_{[x]}$  can be used to conduct byte write operations.

Write operations are qualified by the Write Enable ( $\overline{WE}$ ). All writes are simplified with on-chip synchronous self-timed write circuitry.

Three synchronous Chip Enables ( $\overline{CE}_1$ ,  $\overline{CE}_2$ ,  $\overline{CE}_3$ ) and an asynchronous Output Enable (OE) simplify depth expansion. All operations (Reads, Writes, and Deselects) are pipelined. ADV/LD should be driven LOW once the device has been deselected in order to load a new address for the next operation.

**Single Read Accesses**

A read access is initiated when the following conditions are satisfied at clock rise: (1) CEN is asserted LOW, (2)  $\overline{CE}_1$ ,  $\overline{CE}_2$ , and  $\overline{CE}_3$  are ALL asserted active, (3) the Write Enable input signal WE is deasserted HIGH, and (4) ADV/LD is asserted LOW. The address presented to the address inputs is latched into the Address Register and presented to the memory core and control logic. The control logic determines that a read access is in progress and allows the requested data to propagate to the input of the output register. At the rising edge of the next clock the requested data is allowed to propagate through the output register and onto the data bus within 2.6 ns (200-MHz device) provided OE is active LOW. After the first clock of the read access the output buffers are controlled by

$\overline{OE}$  and the internal control logic.  $\overline{OE}$  must be driven LOW in order for the device to drive out the requested data. During the second clock, a subsequent operation (Read/Write/Deselect) can be initiated. Deselecting the device is also pipelined. Therefore, when the SRAM is deselected at clock rise by one of the chip enable signals, its output will three-state following the next clock rise.

**Burst Read Accesses**

The CY7C1460AV25/CY7C1462AV25/CY7C1464AV25 have an on-chip burst counter that allows the user the ability to supply a single address and conduct up to four Reads without reasserting the address inputs. ADV/LD must be driven LOW in order to load a new address into the SRAM, as described in the Single Read Access section above. The sequence of the burst counter is determined by the MODE input signal. A LOW input on MODE selects a linear burst mode, a HIGH selects an interleaved burst sequence. Both burst counters use A0 and A1 in the burst sequence, and will wrap-around when incremented sufficiently. A HIGH input on ADV/LD will increment the internal burst counter regardless of the state of chip enables inputs or WE. WE is latched at the beginning of a burst cycle. Therefore, the type of access (Read or Write) is maintained throughout the burst sequence.

**Single Write Accesses**

Write access are initiated when the following conditions are satisfied at clock rise: (1) CEN is asserted LOW, (2)  $\overline{CE}_1$ ,  $\overline{CE}_2$ , and  $\overline{CE}_3$  are ALL asserted active, and (3) the write signal WE is asserted LOW. The address presented to the address inputs is loaded into the Address Register. The write signals are latched into the Control Logic block.

On the subsequent clock rise the data lines are automatically three-stated regardless of the state of the OE input signal. This allows the external logic to present the data on DQ and DQP ( $DQ_{a,b,c,d,e,f,g,h}/DQP_{a,b,c,d,e,f,g,h}$  for CY7C1464AV25,  $DQ_{a,b,c,d}/DQP_{a,b,c,d}$  for CY7C1460AV25 and  $DQ_{a,b}/DQP_{a,b}$  for CY7C1462AV25). In addition, the address for the subsequent access (Read/Write/Deselect) is latched into the Address Register (provided the appropriate control signals are asserted).

On the next clock rise the data presented to DQ and DQP ( $DQ_{a,b,c,d,e,f,g,h}/DQP_{a,b,c,d,e,f,g,h}$  for CY7C1464AV25,  $DQ_{a,b,c,d}/DQP_{a,b,c,d}$  for CY7C1460AV25 and  $DQ_{a,b}/DQP_{a,b}$  for CY7C1462AV25) (or a subset for byte write operations, see



Write Cycle Description table for details) inputs is latched into the device and the write is complete.

The data written during the Write operation is controlled by  $\overline{BW}$  ( $BW_{a,b,c,d,e,f,g,h}$  for CY7C1464AV25,  $BW_{a,b,c,d}$  for CY7C1460AV25 and  $BW_{a,b}$  for CY7C1462AV25) signals. The CY7C1460AV25/CY7C1462AV25/CY7C1464AV25 provides byte write capability that is described in the Write Cycle Description table. Asserting the Write Enable input (WE) with the selected Byte Write Select ( $\overline{BW}$ ) input will selectively write to only the desired bytes. Bytes not selected during a byte write operation will remain unaltered. A synchronous self-timed write mechanism has been provided to simplify the write operations. Byte write capability has been included in order to greatly simplify Read/Modify/Write sequences, which can be reduced to simple byte write operations.

Because the CY7C1460AV25/CY7C1462AV25/ CY7C1464AV25 are common I/O devices, data should not be driven into the device while the outputs are active. The Output Enable (OE) can be deasserted HIGH before presenting data to the DQ and DQP ( $DQ_{a,b,c,d,e,f,g,h}/DQP_{a,b,c,d,e,f,g,h}$  for CY7C1464AV25,  $DQ_{a,b,c,d}/DQP_{a,b,c,d}$  for CY7C1460AV25 and  $DQ_{a,b}/DQP_{a,b}$  for CY7C1462AV25) inputs. Doing so will three-state the output drivers. As a safety precaution, DQ and DQP ( $DQ_{a,b,c,d,e,f,g,h}/DQP_{a,b,c,d,e,f,g,h}$  for CY7C1464AV25,  $DQ_{a,b,c,d}/DQP_{a,b,c,d}$  for CY7C1460AV25 and  $DQ_{a,b}/DQP_{a,b}$  for CY7C1462AV25) are automatically three-stated during the data portion of a write cycle, regardless of the state of OE.

**Burst Write Accesses**

The CY7C1460AV25/CY7C1462AV25/CY7C1464AV25 has an on-chip burst counter that allows the user the ability to supply a single address and conduct up to four WRITE operations without reasserting the address inputs. ADV/LD must be driven LOW in order to load the initial address, as described in the Single Write Access section above. When ADV/LD is driven HIGH on the subsequent clock rise, the chip enables ( $CE_1$ ,  $CE_2$ , and  $CE_3$ ) and WE inputs are ignored and the burst counter is incremented. The correct BW ( $BW_{a,b,c,d,e,f,g,h}$  for

CY7C1460AV25,  $\overline{BW}_{a,b,c,d}$  for CY7C1460AV25 and  $\overline{BW}_{a,b}$  for CY7C1462AV25) inputs must be driven in each cycle of the burst write in order to write the correct bytes of data.

**Sleep Mode**

The ZZ input pin is an asynchronous input. Asserting ZZ places the SRAM in a power conservation "sleep" mode. Two clock cycles are required to enter into or exit from this "sleep" mode. While in this mode, data integrity is guaranteed. Accesses pending when entering the "sleep" mode are not considered valid nor is the completion of the operation guaranteed. The device must be deselected prior to entering the "sleep" mode.  $CE_1$ ,  $CE_2$ , and  $CE_3$ , must remain inactive for the duration of  $t_{ZZREC}$  after the ZZ input returns LOW.

**Interleaved Burst Address Table (MODE = Floating or  $V_{DD}$ )**

First Address	Second Address	Third Address	Fourth Address
A1,A0	A1,A0	A1,A0	A1,A0
00	01	10	11
01	00	11	10
10	11	00	01
11	10	01	00

**Linear Burst Address Table (MODE = GND)**

First Address	Second Address	Third Address	Fourth Address
A1,A0	A1,A0	A1,A0	A1,A0
00	01	10	11
01	10	11	00
10	11	00	01
11	00	01	10

**ZZ Mode Electrical Characteristics**

Parameter	Description	Test Conditions	Min.	Max	Unit
$I_{DDZZ}$	Sleep mode standby current	$ZZ \geq V_{DD} - 0.2V$		100	mA
$t_{ZZS}$	Device operation to ZZ	$ZZ \geq V_{DD} - 0.2V$		$2t_{CYC}$	ns
$t_{ZZREC}$	ZZ recovery time	$ZZ \leq 0.2V$	$2t_{CYC}$		ns
$t_{ZZI}$	ZZ active to sleep current	This parameter is sampled		$2t_{CYC}$	ns
$t_{RZZI}$	ZZ Inactive to exit sleep current	This parameter is sampled	0		ns





Truth Table<sup>[1, 2, 3, 4, 5, 6, 7]</sup>

Operation	Address Used	$\overline{CE}$	ZZ	ADV/LD	$\overline{WE}$	$\overline{BW}_x$	$\overline{OE}$	$\overline{CEN}$	CLK	DQ
Deselect Cycle	None	H	L	L	X	X	X	L	L-H	Three-State
Continue Deselect Cycle	None	X	L	H	X	X	X	L	L-H	Three-State
Read Cycle (Begin Burst)	External	L	L	L	H	X	L	L	L-H	Data Out (Q)
Read Cycle (Continue Burst)	Next	X	L	H	X	X	L	L	L-H	Data Out (Q)
NOP/Dummy Read (Begin Burst)	External	L	L	L	H	X	H	L	L-H	Three-State
Dummy Read (Continue Burst)	Next	X	L	H	X	X	H	L	L-H	Three-State
Write Cycle (Begin Burst)	External	L	L	L	L	L	X	L	L-H	Data In (D)
Write Cycle (Continue Burst)	Next	X	L	H	X	L	X	L	L-H	Data In (D)
NOP/WRITE ABORT (Begin Burst)	None	L	L	L	L	H	X	L	L-H	Three-State
WRITE ABORT (Continue Burst)	Next	X	L	H	X	H	X	L	L-H	Three-State
IGNORE CLOCK EDGE (Stall)	Current	X	L	X	X	X	X	H	L-H	-
Sleep MODE	None	X	H	X	X	X	X	X	X	Three-State

Partial Write Cycle Description<sup>[1, 2, 3, 8]</sup>

Function (CY7C1460AV25)	$\overline{WE}$	$\overline{BW}_d$	$\overline{BW}_c$	$\overline{BW}_b$	$\overline{BW}_a$
Read	H	X	X	X	X
Write – No bytes written	L	H	H	H	H
Write Byte a – (DQ <sub>a</sub> and DQP <sub>a</sub> )	L	H	H	H	L
Write Byte b – (DQ <sub>b</sub> and DQP <sub>b</sub> )	L	H	H	L	H
Write Bytes b, a	L	H	H	L	L
Write Byte c – (DQ <sub>c</sub> and DQP <sub>c</sub> )	L	H	L	H	H
Write Bytes c, a	L	H	L	H	L
Write Bytes c, b	L	H	LL	L	H
Write Bytes c, b, a	L	H	L	L	L
Write Byte d – (DQ <sub>d</sub> and DQP <sub>d</sub> )	L	L	H	H	H
Write Bytes d, a	L	L	H	H	L
Write Bytes d, b	L	L	H	L	H
Write Bytes d, b, a	L	L	H	L	L
Write Bytes d, c	L	L	L	H	H
Write Bytes d, c, a	L	L	L	H	L
Write Bytes d, c, b	L	L	L	L	H
Write All Bytes	L	L	L	L	L

Notes:

1. X = "Don't Care", H = Logic HIGH, L = Logic LOW,  $\overline{CE}$  stands for ALL Chip Enables active.  $\overline{BW}_x = L$  signifies at least one Byte Write Select is active,  $\overline{BW}_x = \text{Valid}$  signifies that the desired byte write selects are asserted, see Write Cycle Description table for details.
2. Write is defined by  $\overline{WE}$  and  $\overline{BW}_x$ . See Write Cycle Description table for details.
3. When a write cycle is detected, all I/Os are tri-stated, even during byte writes.
4. The DQ and DQP pins are controlled by the current cycle and the  $\overline{OE}$  signal.
5.  $\overline{CEN} = H$  inserts wait states.
6. Device will power-up deselected and the I/Os in a tri-state condition, regardless of  $\overline{OE}$ .
7.  $\overline{OE}$  is asynchronous and is not sampled with the clock rise. It is masked internally during write cycles. During a read cycle DQ<sub>s</sub> and DQP<sub>x</sub> = Three-state when  $\overline{OE}$  is inactive or when the device is deselected, and DQ<sub>s</sub>=data when  $\overline{OE}$  is active.
8. Table only lists a partial listing of the byte write combinations. Any combination of  $\overline{BW}_x$  is valid. Appropriate write will be done based on which byte write is active.

Function (CY7C1462AV25)	$\overline{WE}$	$\overline{BW}_b$	$\overline{BW}_a$
Read	H	x	x
Write – No Bytes Written	L	H	H
Write Byte a – (DQ <sub>a</sub> and DQP <sub>a</sub> )	L	H	L
Write Byte b – (DQ <sub>b</sub> and DQP <sub>b</sub> )	L	L	H
Write Both Bytes	L	L	L
Function (CY7C1464AV25)	$\overline{WE}$	$\overline{BW}_x$	
Read	H	x	
Write – No Bytes Written	L	H	
Write Byte X – (DQ <sub>x</sub> and DQP <sub>x</sub> )	L	L	
Write All Bytes	L	All $\overline{BW} = L$	

### IEEE 1149.1 Serial Boundary Scan (JTAG)

The CY7C1460AV25/CY7C1462AV25/CY7C1464AV25 incorporates a serial boundary scan test access port (TAP). This part is fully compliant with 1149.1. The TAP operates using JEDEC-standard 2.5V/1.8V I/O logic level.

The CY7C1460AV25/CY7C1462AV25/CY7C1464AV25 contains a TAP controller, instruction register, boundary scan register, bypass register, and ID register.

#### Disabling the JTAG Feature

It is possible to operate the SRAM without using the JTAG feature. To disable the TAP controller, TCK must be tied LOW(V<sub>ss</sub>) to prevent clocking of the device. TDI and TMS are internally pulled up and may be unconnected. They may alternately be connected to V<sub>DD</sub> through a pull-up resistor. TDO should be left unconnected. Upon power-up, the device will come up in a reset state which will not interfere with the operation of the device.

### TAP Controller State Diagram

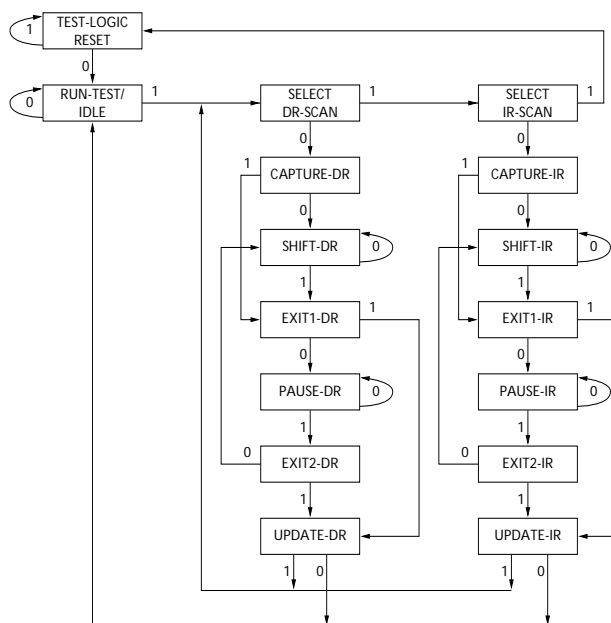

The 0/1 next to each state represents the value of TMS at the rising edge of TCK.

### Test Access Port (TAP)

#### Test Clock (TCK)

The test clock is used only with the TAP controller. All inputs are captured on the rising edge of TCK. All outputs are driven from the falling edge of TCK.

#### Test MODE SELECT (TMS)

The TMS input is used to give commands to the TAP controller and is sampled on the rising edge of TCK. It is allowable to leave this ball unconnected if the TAP is not used. The ball is pulled up internally, resulting in a logic HIGH level.

#### Test Data-In (TDI)

The TDI ball is used to serially input information into the registers. The register between TDI and TDO is chosen by the instruction that is loaded into the TAP instruction register. For information on loading the instruction register, see Figure . TDI is internally pulled up and can be unconnected if the TAP is unused in an application. TDI is connected to the most significant bit (MSB) of any register. (See Tap Controller Block Diagram.)

#### Test Data-Out (TDO)

The TDO output ball is used to serially clock data-out from the registers. The output is active depending upon the current state of the TAP state machine. The output changes on the falling edge of TCK. TDO is connected to the least significant bit (LSB) of any register. (See Tap Controller State Diagram.)

## TAP Controller Block Diagram

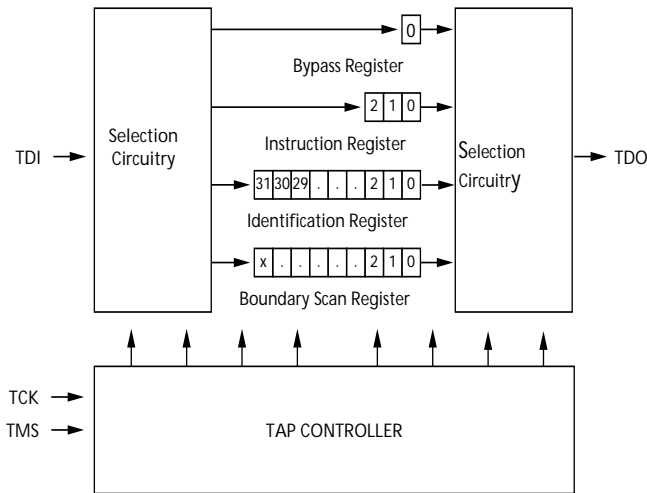

### Performing a TAP Reset

A RESET is performed by forcing TMS HIGH (VDD) for five rising edges of TCK. This RESET does not affect the operation of the SRAM and may be performed while the SRAM is operating.

At power-up, the TAP is reset internally to ensure that TDO comes up in a High-Z state.

### TAP Registers

Registers are connected between the TDI and TDO balls and allow data to be scanned into and out of the SRAM test circuitry. Only one register can be selected at a time through the instruction register. Data is serially loaded into the TDI ball on the rising edge of TCK. Data is output on the TDO ball on the falling edge of TCK.

### Instruction Register

Three-bit instructions can be serially loaded into the instruction register. This register is loaded when it is placed between the TDI and TDO balls as shown in the Tap Controller Block Diagram. Upon power-up, the instruction register is loaded with the IDCODE instruction. It is also loaded with the IDCODE instruction if the controller is placed in a reset state as described in the previous section.

When the TAP controller is in the Capture-IR state, the two least significant bits are loaded with a binary "01" pattern to allow for fault isolation of the board-level serial test data path.

### Bypass Register

To save time when serially shifting data through registers, it is sometimes advantageous to skip certain chips. The bypass register is a single-bit register that can be placed between the TDI and TDO balls. This allows data to be shifted through the SRAM with minimal delay. The bypass register is set LOW (Vss) when the BYPASS instruction is executed.

### Boundary Scan Register

The boundary scan register is connected to all the input and bidirectional balls on the SRAM. The length of the Boundary Scan Register for the SRAM in different packages is listed in the Scan Register Sizes table.

The boundary scan register is loaded with the contents of the RAM I/O ring when the TAP controller is in the Capture-DR state and is then placed between the TDI and TDO balls when the controller is moved to the Shift-DR state. The EXTEST, SAMPLE/PRELOAD and SAMPLE Z instructions can be used to capture the contents of the I/O ring.

The Boundary Scan Order tables show the order in which the bits are connected. Each bit corresponds to one of the bumps on the SRAM package. The MSB of the register is connected to TDI, and the LSB is connected to TDO.

The ID register is loaded with a vendor-specific, 32-bit code during the Capture-DR state when the IDCODE command is loaded in the instruction register. The IDCODE is hardwired into the SRAM and can be shifted out when the TAP controller is in the Shift-DR state. The ID register has a vendor code and other information described in the Identification Register Definitions table.

### Identification (ID) Register

The ID register is loaded with a vendor-specific, 32-bit code during the Capture-DR state when the IDCODE command is loaded in the instruction register. The IDCODE is hardwired into the SRAM and can be shifted out when the TAP controller is in the Shift-DR state. The ID register has a vendor code and other information described in the Identification Register Definitions table.

### TAP Instruction Set

#### Overview

Eight different instructions are possible with the three bit instruction register. All combinations are listed in the Instruction Codes table. Three of these instructions are listed as RESERVED and should not be used. The other five instructions are described in detail below.

Instructions are loaded into the TAP controller during the Shift-IR state when the instruction register is placed between TDI and TDO. During this state, instructions are shifted through the instruction register through the TDI and TDO balls. To execute the instruction once it is shifted in, the TAP controller needs to be moved into the Update-IR state.

#### IDCODE

The IDCODE instruction causes a vendor-specific, 32-bit code to be loaded into the instruction register. It also places the instruction register between the TDI and TDO balls and allows the IDCODE to be shifted out of the device when the TAP controller enters the Shift-DR state.

The IDCODE instruction is loaded into the instruction register upon power-up or whenever the TAP controller is given a test logic reset state.

#### SAMPLE Z

The SAMPLE Z instruction causes the boundary scan register to be connected between the TDI and TDO pins when the TAP controller is in a Shift-DR state. The SAMPLE Z command puts the output bus into a High-Z state until the next command is given during the "Update IR" state.

#### SAMPLE/PRELOAD

SAMPLE/PRELOAD is a 1149.1-mandatory instruction. When the SAMPLE/PRELOAD instructions are loaded into the instruction register and the TAP controller is in the Capture-DR state, a snapshot of data on the inputs and output pins is captured in the boundary scan register.

The user must be aware that the TAP controller clock can only operate at a frequency up to 20 MHz, while the SRAM clock operates more than an order of magnitude faster. Because there is a large difference in the clock frequencies, it is possible that during the Capture-DR state, an input or output will undergo a transition. The TAP may then try to capture a signal while in transition (metastable state). This will not harm the device, but there is no guarantee as to the value that will be captured. Repeatable results may not be possible.

To guarantee that the boundary scan register will capture the correct value of a signal, the SRAM signal must be stabilized long enough to meet the TAP controller's capture set-up plus hold times ( $t_{CS}$  and  $t_{CH}$ ). The SRAM clock input might not be captured correctly if there is no way in a design to stop (or slow) the clock during a SAMPLE/PRELOAD instruction. If this is an issue, it is still possible to capture all other signals and simply ignore the value of the CK and CK# captured in the boundary scan register.

Once the data is captured, it is possible to shift out the data by putting the TAP into the Shift-DR state. This places the boundary scan register between the TDI and TDO pins.

PRELOAD allows an initial data pattern to be placed at the latched parallel outputs of the boundary scan register cells prior to the selection of another boundary scan test operation.

The shifting of data for the SAMPLE and PRELOAD phases can occur concurrently when required - that is, while data captured is shifted out, the preloaded data can be shifted in.

### BYPASS

When the BYPASS instruction is loaded in the instruction register and the TAP is placed in a Shift-DR state, the bypass register is placed between the TDI and TDO pins. The advantage of the BYPASS instruction is that it shortens the boundary scan path when multiple devices are connected together on a board.

### EXTEST

The EXTEST instruction enables the preloaded data to be driven out through the system output pins. This instruction also

selects the boundary scan register to be connected for serial access between the TDI and TDO in the shift-DR controller state.

### EXTEST Output Bus Tri-State

IEEE Standard 1149.1 mandates that the TAP controller be able to put the output bus into a tri-state mode.

The boundary scan register has a special bit located at bit #89 (for 165-FBGA package) or bit #138 (for 209 BGA package). When this scan cell, called the "extest output bus tri-state," is latched into the preload register during the "Update-DR" state in the TAP controller, it will directly control the state of the output (Q-bus) pins, when the EXTEST is entered as the current instruction. When HIGH, it will enable the output buffers to drive the output bus. When LOW, this bit will place the output bus into a High-Z condition.

This bit can be set by entering the SAMPLE/PRELOAD or EXTEST command, and then shifting the desired bit into that cell, during the "Shift-DR" state. During "Update-DR," the value loaded into that shift-register cell will latch into the preload register. When the EXTEST instruction is entered, this bit will directly control the output Q-bus pins. Note that this bit is preset HIGH to enable the output when the device is powered-up, and also when the TAP controller is in the "Test-Logic-Reset" state.

### Reserved

These instructions are not implemented but are reserved for future use. Do not use these instructions.

## TAP Timing

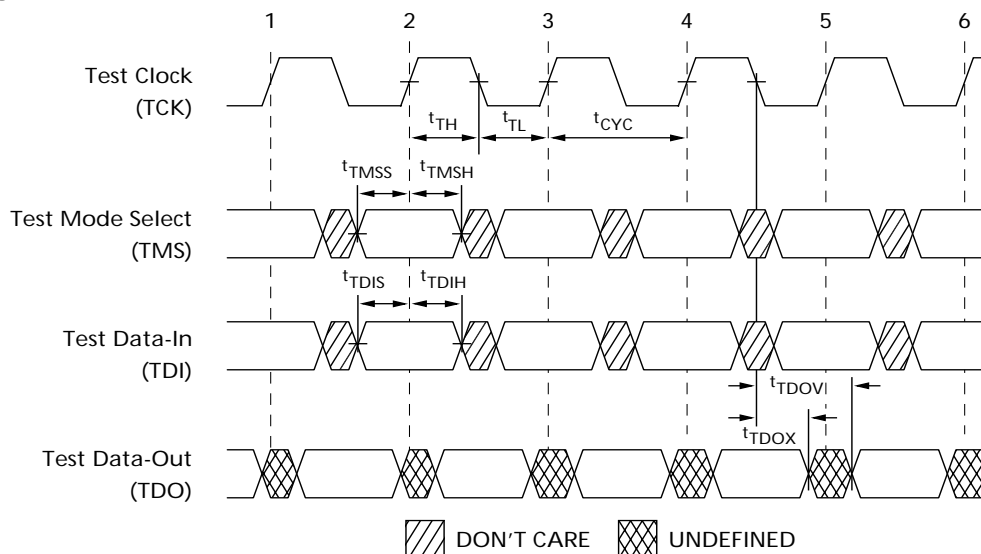



**TAP AC Switching Characteristics** Over the Operating Range<sup>[9, 10]</sup>

Parameter	Description	Min.	Max.	Unit
<b>Clock</b>				
t <sub>TCYC</sub>	TCK Clock Cycle Time	50		ns
t <sub>TF</sub>	TCK Clock Frequency		20	MHz
t <sub>TH</sub>	TCK Clock HIGH time	25		ns
t <sub>TL</sub>	TCK Clock LOW time	25		ns
<b>Output Times</b>				
t <sub>TDOV</sub>	TCK Clock LOW to TDO Valid		5	ns
t <sub>TDOX</sub>	TCK Clock LOW to TDO Invalid	0		ns
<b>Set-up Times</b>				
t <sub>TMSS</sub>	TMS Set-up to TCK Clock Rise	5		ns
t <sub>TDIS</sub>	TDI Set-up to TCK Clock Rise	5		ns
t <sub>CS</sub>	Capture Set-up to TCK Rise	5		ns
<b>Hold Times</b>				
t <sub>TMSH</sub>	TMS hold after TCK Clock Rise	5		ns
t <sub>TDIH</sub>	TDI Hold after Clock Rise	5		ns
t <sub>CH</sub>	Capture Hold after Clock Rise	5		ns

**Notes:**

- 9. t<sub>CS</sub> and t<sub>CH</sub> refer to the set-up and hold time requirements of latching data from the boundary scan register.
- 10. Test conditions are specified using the load in TAP AC test Conditions. t<sub>r</sub>/t<sub>f</sub> = 1 ns.

**2.5V TAP AC Test Conditions**

Input pulse levels .....  $V_{SS}$  to 2.5V  
 Input rise and fall time ..... 1 ns  
 Input timing reference levels ..... 1.25V  
 Output reference levels ..... 1.25V  
 Test load termination supply voltage ..... 1.25V

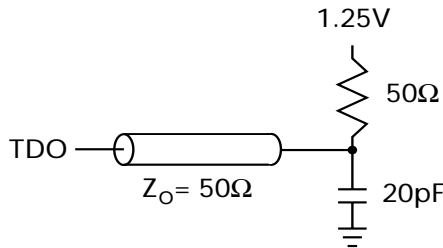
**2.5V TAP AC Output Load Equivalent**

**1.8V TAP AC Test Conditions**

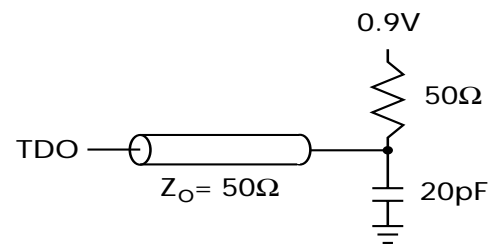
Input pulse levels ..... 0.2V to  $V_{DDQ} - 0.2$   
 Input rise and fall time ..... 1 ns  
 Input timing reference levels ..... 0.9V  
 Output reference levels ..... 0.9V  
 Test load termination supply voltage ..... 0.9V

**1.8V TAP AC Output Load Equivalent**

**TAP DC Electrical Characteristics And Operating Conditions**

( $0^{\circ}\text{C} < T_A < +70^{\circ}\text{C}$ ;  $V_{DD} = 2.5\text{V} \pm 0.125\text{V}$  unless otherwise noted)<sup>[11]</sup>

Parameter	Description	Test Conditions		Min.	Max.	Unit
$V_{OH1}$	Output HIGH Voltage	$I_{OH} = -1.0 \text{ mA}$	$V_{DDQ} = 2.5\text{V}$	1.7		V
$V_{OH2}$	Output HIGH Voltage	$I_{OH} = -100 \mu\text{A}$	$V_{DDQ} = 2.5\text{V}$	2.1		V
			$V_{DDQ} = 1.8\text{V}$	1.6		V
$V_{OL1}$	Output LOW Voltage	$I_{OL} = 1.0 \text{ mA}$	$V_{DDQ} = 2.5\text{V}$		0.4	V
$V_{OL2}$	Output LOW Voltage	$I_{OL} = 100 \mu\text{A}$	$V_{DDQ} = 2.5\text{V}$		0.2	V
			$V_{DDQ} = 1.8\text{V}$		0.2	V
$V_{IH}$	Input HIGH Voltage		$V_{DDQ} = 2.5\text{V}$	1.7	$V_{DD} + 0.3$	V
			$V_{DDQ} = 1.8\text{V}$	1.26	$V_{DD} + 0.3$	V
$V_{IL}$	Input LOW Voltage		$V_{DDQ} = 2.5\text{V}$	-0.3	0.7	V
			$V_{DDQ} = 1.8\text{V}$	-0.3	0.36	V
$I_X$	Input Load Current	$\text{GND} \leq V_I \leq V_{DDQ}$		-5	5	$\mu\text{A}$

**Identification Register Definitions**

Instruction Field	CY7C1460AV25 (1M x36)	CY7C1462AV25 (2M x18)	CY7C1464AV25 (512k x72)	Description
Revision Number (31:29)	000	000	000	Describes the version number
Device Depth (28:24)	01011	01011	01011	Reserved for Internal Use
Architecture/Memory Type(23:18)	001000	001000	001000	Defines memory type and architecture
Bus Width/Density(17:12)	100111	010111	110111	Defines width and density
Cypress JEDEC ID Code (11:1)	00000110100	00000110100	00000110100	Allows unique identification of SRAM vendor
ID Register Presence Indicator (0)	1	1	1	Indicates the presence of an ID register

**Note:**

11. All voltages referenced to  $V_{SS}$  (GND).



**Scan Register Sizes**

Register Name	Bit Size (x36)	Bit Size (x18)	Bit Size (x72)
Instruction	3	3	3
Bypass	1	1	1
ID	32	32	32
Boundary Scan Order–165FBGA	89	89	–
Boundary Scan Order–209BGA	–	–	138

**Identification Codes**

Instruction	Code	Description
EXTEST	000	Captures I/O ring contents. Places the boundary scan register between TDI and TDO. Forces all SRAM outputs to High-Z state.
IDCODE	001	Loads the ID register with the vendor ID code and places the register between TDI and TDO. This operation does not affect SRAM operations.
SAMPLE Z	010	Captures I/O ring contents. Places the boundary scan register between TDI and TDO. Forces all SRAM output drivers to a High-Z state.
RESERVED	011	Do Not Use: This instruction is reserved for future use.
SAMPLE/PRELOAD	100	Captures I/O ring contents. Places the boundary scan register between TDI and TDO. Does not affect SRAM operation.
RESERVED	101	Do Not Use: This instruction is reserved for future use.
RESERVED	110	Do Not Use: This instruction is reserved for future use.
BYPASS	111	Places the bypass register between TDI and TDO. This operation does not affect SRAM operations.



**165-Ball fBGA Boundary Scan Order <sup>[12]</sup>**

<b>CY7C1460AV25 (1 Mbit x 36)</b>			
<b>Bit#</b>	<b>Ball ID</b>	<b>Bit#</b>	<b>Ball ID</b>
1	N6	42	A7
2	N7	43	B7
3	N10	44	B6
4	P11	45	A6
5	P8	46	B5
6	R8	47	A5
7	R9	48	A4
8	P9	49	B4
9	P10	50	B3
10	R10	51	A3
11	R11	52	A2
12	H11	53	B2
13	N11	54	C2
14	M11	55	B1
15	L11	56	A1
16	K11	57	C1
17	J11	58	D1
18	M10	59	E1
19	L10	60	F1
20	K10	61	G1
21	J10	62	D2
22	H9	63	E2
23	H10	64	F2
24	G11	65	G2
25	F11	66	H1
26	E11	67	H3
27	D11	68	J1
28	G10	69	K1
29	F10	70	L1
30	E10	71	M1
31	D10	72	J2
32	C11	73	K2
33	A11	74	L2
34	B11	75	M2
35	A10	76	N1
36	B10	77	N2
37	A9	78	P1
38	B9	79	R1
39	C10	80	R2
40	A8	81	P3
41	B8	82	R3

<b>CY7C1460AV25 (1 Mbit x 36)</b>	
<b>Bit#</b>	<b>Ball ID</b>
83	P2
84	R4
85	P4
86	N5
87	P6
88	R6
89	Internal
<b>CY7C1462AV25 (2 Mbit x 18)</b>	
1	N6
2	N7
3	10N
4	P11
5	P8
6	R8
7	R9
8	P9
9	P10
10	R10
11	R11
12	H11
13	N11
14	M11
15	L11
16	K11
17	J11
18	M10
19	L10
20	K10
21	J10
22	H9
23	H10
24	G11
25	F11
26	E11
27	D11
28	G10
29	F10
30	E10
31	D10
32	C11

**Note:**  
12. Bit# 89 is preset HIGH.



**PRELIMINARY**

**CY7C1460AV25  
CY7C1462AV25  
CY7C1464AV25**

**165-Ball fBGA Boundary Scan Order <sup>[12]</sup>**

CY7C1462AV25 (2 Mbit x 18)			
Bit#	Ball ID	Bit#	Ball ID
33	A11	61	G1
34	B11	62	D2
35	A10	63	E2
36	B10	64	F2
37	A9	65	G2
38	B9	66	H1
39	C10	67	H3
40	A8	68	J1
41	B8	69	K1
42	A7	70	L1
43	B7	71	M1
44	B6	72	J2
45	A6	73	K2
46	B5	74	L2
47	A5	75	M2

**165-Ball fBGA Boundary Scan Order (continued) <sup>[12]</sup>**

CY7C1462AV25 (2 Mbit x 18)			
Bit#	Ball ID	Bit#	Ball ID
48	A4	76	N1
49	B4	77	N2
50	B3	78	P1
51	A3	79	R1
52	A2	80	R2
53	B2	81	P3
54	C2	82	R3
55	B1	83	P2
56	A1	84	R4
57	C1	85	P4
58	D1	86	N5
59	E1	87	P6
60	F1	88	R6
		89	Internal

**209-Ball BGA Boundary Scan Order <sup>[12, 13]</sup>**

CY7C1464AV25 (512K x 72)			
Bit#	Ball ID	Bit#	Ball ID
1	W6	35	J6
2	V6	36	F6
3	U6	37	K8
4	W7	38	K9
5	V7	39	K10
6	U7	40	J11
7	T7	41	J10
8	V8	42	H11
9	U8	43	H10
10	T8	44	G11
11	V9	45	G10
12	U9	46	F11
13	P6	47	F10
14	W11	48	E10
15	W10	49	E11
16	V11	50	D11
17	V10	51	D10
18	U11	52	C11
19	U10	53	C10
20	T11	54	B11
21	T10	55	B10
22	R11	56	A11
23	R10	57	A10
24	P11	58	C9

CY7C1464AV25 (512K x 72)			
Bit#	Ball ID	Bit#	Ball ID
69	D6	104	K1
70	G6	105	N6
71	H6	106	K3
72	C6	107	K4
73	B6	108	K6
74	A6	109	K2
75	A5	110	L2
76	B5	111	L1
77	C5	112	M2
78	D5	113	M1
79	D4	114	N2
80	C4	115	N1
81	A4	116	P2
82	B4	117	P1
83	C3	118	R2
84	B3	119	R1
85	A3	120	T2
86	A2	121	T1
87	A1	122	U2
88	B2	123	U1
89	B1	124	V2
90	C2	125	V1
91	C1	126	W2
92	D2	127	W1

**Note:**  
13. Bit# 138 is preset HIGH.



**PRELIMINARY**

**CY7C1460AV25  
CY7C1462AV25  
CY7C1464AV25**

**209-Ball BGA Boundary Scan Order (continued)<sup>[12, 13]</sup>**

<b>CY7C1464AV25 (512K x 72)</b>			
<b>Bit#</b>	<b>Ball ID</b>	<b>Bit#</b>	<b>Ball ID</b>
25	P10	59	B9
26	N11	60	A9
27	N10	61	D8
28	M11	62	C8
29	M10	63	B8
30	L11	64	A8
31	L10	65	D7
32	K11	66	C7
33	M6	67	B7
34	L6	68	A7

<b>CY7C1464AV25 (512K x 72)</b>			
<b>Bit#</b>	<b>Ball ID</b>	<b>Bit#</b>	<b>Ball ID</b>
93	D1	128	T6
94	E1	129	U3
95	E2	130	V3
96	F2	131	T4
97	F1	132	T5
98	G1	133	U4
99	G2	134	V4
100	H2	135	W5
101	H1	136	V5
102	J2	137	U5
103	J1	138	Internal



**PRELIMINARY**

**CY7C1460AV25  
CY7C1462AV25  
CY7C1464AV25**

**Maximum Ratings**

(Above which the useful life may be impaired. For user guidelines, not tested.)

- Storage Temperature ..... -65°C to +150°C
- Ambient Temperature with Power Applied..... -55°C to +125°C
- Supply Voltage on V<sub>DD</sub> Relative to GND..... -0.5V to +3.6V
- DC to Outputs in Tri-State ..... -0.5V to V<sub>DDQ</sub> + 0.5V
- DC Input Voltage ..... -0.5V to V<sub>DD</sub> + 0.5V

- Current into Outputs (LOW)..... 20 mA
- Static Discharge Voltage..... > 2001V (per MIL-STD-883, Method 3015)
- Latch-up Current..... > 200 mA

**Operating Range**

Range	Ambient Temperature	V <sub>DD</sub>	V <sub>DDQ</sub>
Commercial	0°C to +70°C	2.5V-5%/+5%	1.7V to V <sub>DD</sub>

**Electrical Characteristics** Over the Operating Range<sup>[14, 15]</sup>

Parameter	Description	Test Conditions	Min.	Max.	Unit
V <sub>DD</sub>	Power Supply Voltage		2.375	2.625	V
V <sub>DDQ</sub>	I/O Supply Voltage	V <sub>DDQ</sub> = 2.5V	2.375	V <sub>DD</sub>	V
		V <sub>DDQ</sub> = 1.8V	1.7	1.9	V
V <sub>OH</sub>	Output HIGH Voltage	V <sub>DD</sub> = Min., I <sub>OH</sub> = -1.0 mA, V <sub>DDQ</sub> = 2.5V	2.0		V
		V <sub>DD</sub> = Min., I <sub>OH</sub> = -100 μA, V <sub>DDQ</sub> = 1.8V	1.6		V
V <sub>OL</sub>	Output LOW Voltage	V <sub>DD</sub> = Max., I <sub>OL</sub> = 1.0 mA, V <sub>DDQ</sub> = 2.5V		0.4	V
		V <sub>DD</sub> = Max., I <sub>OL</sub> = 100 μA, V <sub>DDQ</sub> = 1.8V		0.2	V
V <sub>IH</sub>	Input HIGH Voltage <sup>[14]</sup>	V <sub>DDQ</sub> = 2.5V	1.7	V <sub>DD</sub> + 0.3V	V
		V <sub>DDQ</sub> = 1.8V	1.26	V <sub>DD</sub> + 0.3V	V
V <sub>IL</sub>	Input LOW Voltage <sup>[14]</sup>	V <sub>DDQ</sub> = 2.5V	-0.3	0.7	V
		V <sub>DDQ</sub> = 1.8V	-0.3	0.36	V
I <sub>X</sub>	Input Load Current except ZZ and MODE	GND ≤ V <sub>I</sub> ≤ V <sub>DDQ</sub>	-5	5	μA
		Input = V <sub>SS</sub>	-5		μA
	Input Current of MODE	Input = V <sub>DD</sub>		30	μA
		Input = V <sub>SS</sub>	-30		μA
Input Current of ZZ	Input = V <sub>SS</sub>		5	μA	
	Input = V <sub>DD</sub>				μA
I <sub>OZ</sub>	Output Leakage Current	GND ≤ V <sub>I</sub> ≤ V <sub>DDQ</sub> , Output Disabled	-5	5	μA
I <sub>DD</sub>	V <sub>DD</sub> Operating Supply	V <sub>DD</sub> = Max., I <sub>OUT</sub> = 0 mA, f = f <sub>MAX</sub> = 1/t <sub>CYC</sub>	4.0-ns cycle, 250 MHz	435	mA
			5.0-ns cycle, 200 MHz	385	mA
			6.0-ns cycle, 167 MHz	335	mA
I <sub>SB1</sub>	Automatic CE Power-down Current—TTL Inputs	Max. V <sub>DD</sub> , Device Deselected, V <sub>IN</sub> ≥ V <sub>IH</sub> or V <sub>IN</sub> ≤ V <sub>IL</sub> , f = f <sub>MAX</sub> = 1/t <sub>CYC</sub>	4.0-ns cycle, 250 MHz	185	mA
			5.0-ns cycle, 200 MHz	185	mA
			6.0-ns cycle, 167 MHz	185	mA
I <sub>SB2</sub>	Automatic CE Power-down Current—CMOS Inputs	Max. V <sub>DD</sub> , Device Deselected, V <sub>IN</sub> ≤ 0.3V or V <sub>IN</sub> ≥ V <sub>DDQ</sub> - 0.3V, f = 0	All speed grades	100	mA
I <sub>SB3</sub>	Automatic CE Power-down Current—CMOS Inputs	Max. V <sub>DD</sub> , Device Deselected, V <sub>IN</sub> ≤ 0.3V or V <sub>IN</sub> ≥ V <sub>DDQ</sub> - 0.3V, f = f <sub>MAX</sub> = 1/t <sub>CYC</sub>	4.0-ns cycle, 250 MHz	160	mA
			5.0-ns cycle, 200 MHz	160	mA
			6.0-ns cycle, 167 MHz	160	mA
I <sub>SB4</sub>	Automatic CE Power-down Current—TTL Inputs	Max. V <sub>DD</sub> , Device Deselected, V <sub>IN</sub> ≥ V <sub>IH</sub> or V <sub>IN</sub> ≤ V <sub>IL</sub> , f = 0	All speed grades	110	mA

Shaded areas contain advance information.

**Notes:**

- 14. Overshoot: V<sub>IH</sub>(AC) < V<sub>DD</sub> + 1.5V (Pulse width less than tcyc/2), undershoot: V<sub>IL</sub>(AC) > -2V (Pulse width less than tcyc/2).
- 15. T<sub>Power-up</sub>: Assumes a linear ramp from 0V to V<sub>DD</sub> (min.) within 200ms. During this time V<sub>IH</sub> < V<sub>DD</sub> and V<sub>DDQ</sub> < V<sub>DD</sub>.

**Thermal Resistance<sup>[16]</sup>**

Parameters	Description	Test Conditions	100 TQFP	165 FBGA	209 FBGA	Unit
$\Theta_{JA}$	Thermal Resistance (Junction to Ambient)	Test conditions follow standard test methods and procedures for measuring thermal impedance, per EIA/JESD51.	25.21	20.8	25.31	°C/W
$\Theta_{JC}$	Thermal Resistance (Junction to Case)		2.58	3.2	4.48	°C/W

**Capacitance<sup>[16]</sup>**

Parameter	Description	Test Conditions	100 TQFP	165 FBGA	209 FBGA	Unit
$C_{IN}$	Input Capacitance	$T_A = 25^\circ\text{C}$ , $f = 1\text{ MHz}$ , $V_{DD} = 2.5\text{V}$ $V_{DDQ} = 2.5\text{V}$	6.5	5	5	pF
$C_{CLK}$	Clock Input Capacitance		3	5	5	pF
$C_{I/O}$	Input/Output Capacitance		5.5	7	7	pF

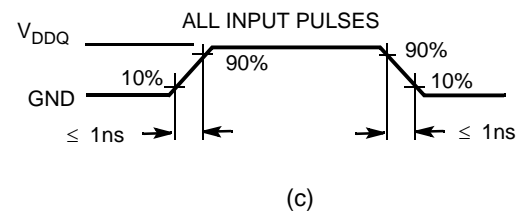
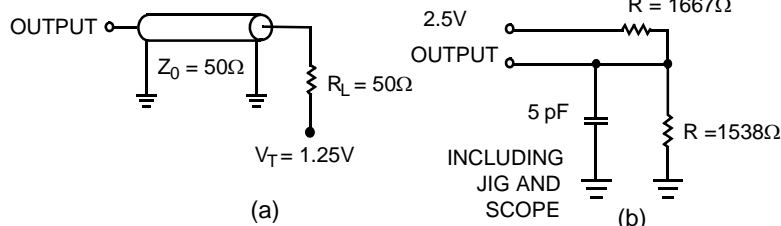
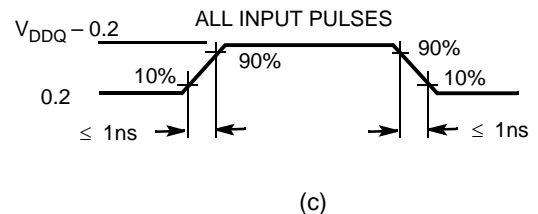
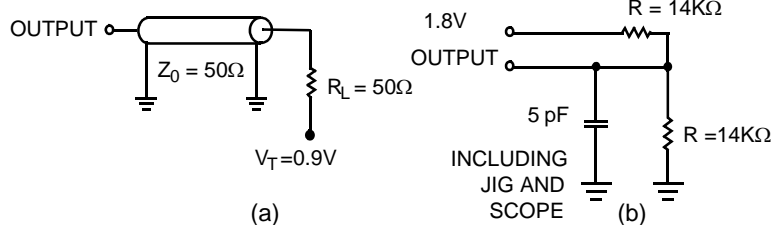
**AC Test Loads and Waveforms**
**2.5V I/O Test Load**

**1.8V I/O Test Load**

**Switching Characteristics Over the Operating Range [ 21, 22]**

Parameter	Description	250		200		167		Unit
		Min.	Max.	Min.	Max.	Min.	Max.	
$t_{Power}^{[17]}$	$V_{CC}$ (typical) to the first access read or write	1		1		1		ms
<b>Clock</b>								
$t_{CYC}$	Clock Cycle Time	4.0		5.0		6.0		ns
$F_{MAX}$	Maximum Operating Frequency		250		200		167	MHz
$t_{CH}$	Clock HIGH	1.5		2.0		2.4		ns
$t_{CL}$	Clock LOW	1.5		2.0		2.4		ns
<b>Output Times</b>								
$t_{CO}$	Data Output Valid After CLK Rise		2.6		3.2		3.4	ns
$t_{EOV}$	OE LOW to Output Valid		2.6		3.0		3.4	ns
$t_{DOH}$	Data Output Hold After CLK Rise	1.0		1.5		1.5		ns
$t_{CHZ}$	Clock to High-Z <sup>[18, 19, 20]</sup>		2.6		3.0		3.4	ns

**Notes:**

16. Tested initially and after any design or process changes that may affect these parameters.
17. This part has a voltage regulator internally;  $t_{power}$  is the time power needs to be supplied above  $V_{dd}$  minimum initially, before a Read or Write operation can be initiated.
18.  $t_{CHZ}$ ,  $t_{CLZ}$ ,  $t_{EOLZ}$ , and  $t_{EOHZ}$  are specified with AC test conditions shown in (b) of AC Test Loads. Transition is measured  $\pm 200\text{ mV}$  from steady-state voltage.
19. At any given voltage and temperature,  $t_{EOHZ}$  is less than  $t_{EOLZ}$  and  $t_{CHZ}$  is less than  $t_{CLZ}$  to eliminate bus contention between SRAMs when sharing the same data bus. These specifications do not imply a bus contention condition, but reflect parameters guaranteed over worst case user conditions. Device is designed to achieve High-Z prior to Low-Z under the same system conditions.
20. This parameter is sampled and not 100% tested.
21. Timing reference is 1.25V when  $V_{DDQ} = 2.5\text{V}$  and 0.9V when  $V_{DDQ} = 1.8\text{V}$ .
22. Test conditions shown in (a) of AC Test Loads unless otherwise noted.



**Switching Characteristics** Over the Operating Range (continued)<sup>[21, 22]</sup>

Parameter	Description	250		200		167		Unit
		Min.	Max.	Min.	Max.	Min.	Max.	
$t_{CLZ}$	Clock to Low-Z <sup>[18, 19, 20]</sup>	1.0		1.3		1.5		ns
$t_{EOHZ}$	$\overline{OE}$ HIGH to Output High-Z <sup>[18, 19, 20]</sup>		2.6		3.0		3.4	ns
$t_{EOLZ}$	$\overline{OE}$ LOW to Output Low-Z <sup>[18, 19, 20]</sup>	0		0		0		ns
<b>Set-up Times</b>								
$t_{AS}$	Address Set-up Before CLK Rise	1.2		1.4		1.5		ns
$t_{DS}$	Data Input Set-up Before CLK Rise	1.2		1.4		1.5		ns
$t_{CENS}$	$\overline{CEN}$ Set-up Before CLK Rise	1.2		1.4		1.5		ns
$t_{WES}$	$\overline{WE}$ , $\overline{BW}_x$ Set-up Before CLK Rise	1.2		1.4		1.5		ns
$t_{ALS}$	ADV/LD Set-up Before CLK Rise	1.2		1.4		1.5		ns
$t_{CES}$	Chip Select Set-up	1.2		1.4		1.5		ns
<b>Hold Times</b>								
$t_{AH}$	Address Hold After CLK Rise	0.3		0.4		0.5		ns
$t_{DH}$	Data Input Hold After CLK Rise	0.3		0.4		0.5		ns
$t_{CENH}$	$\overline{CEN}$ Hold After CLK Rise	0.3		0.4		0.5		ns
$t_{WEH}$	$\overline{WE}$ , $\overline{BW}_x$ Hold After CLK Rise	0.3		0.4		0.5		ns
$t_{ALH}$	ADV/LD Hold after CLK Rise	0.3		0.4		0.5		ns
$t_{CEH}$	Chip Select Hold After CLK Rise	0.3		0.4		0.5		ns

Shaded areas contain advance information.

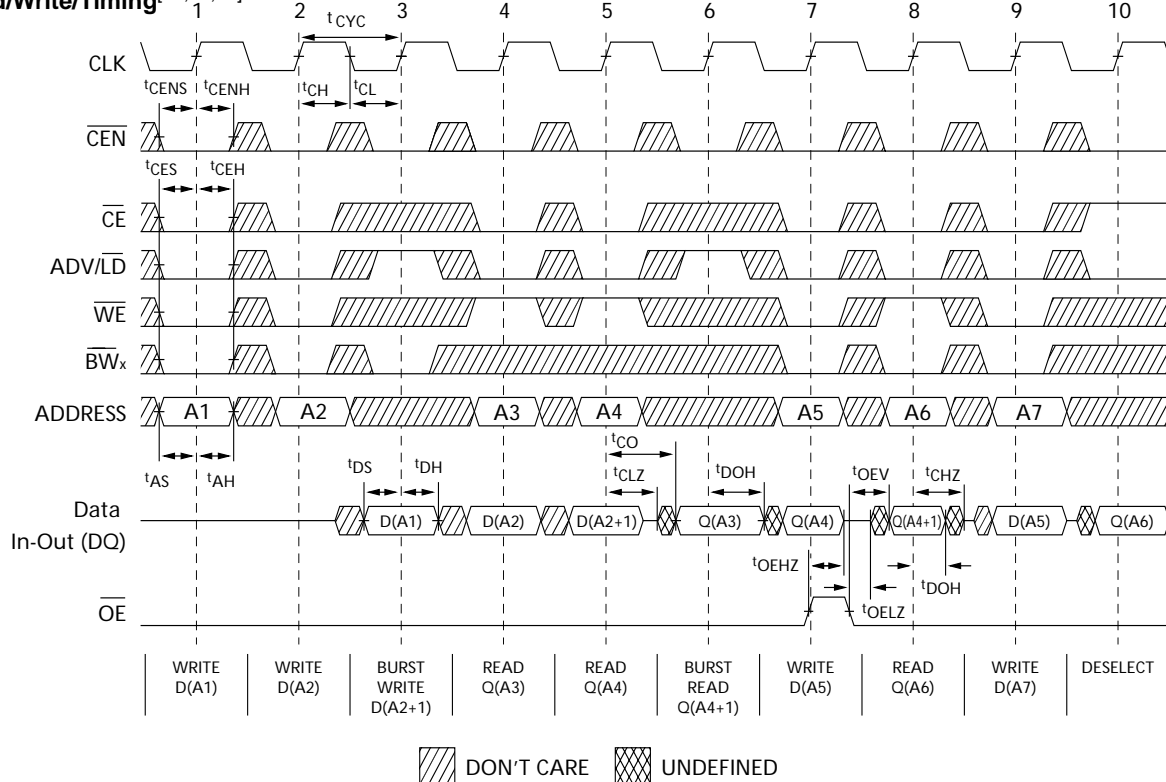
**Switching Waveforms**
**Read/Write/Timing**<sup>[23,24,25]</sup>

**Notes:**

23. For this waveform ZZ is tied low.

24. When CE is LOW,  $\overline{CE}_1$  is LOW,  $\overline{CE}_2$  is HIGH and  $\overline{CE}_3$  is LOW. When  $\overline{CE}$  is HIGH,  $\overline{CE}_1$  is HIGH or  $\overline{CE}_2$  is LOW or  $\overline{CE}_3$  is HIGH.

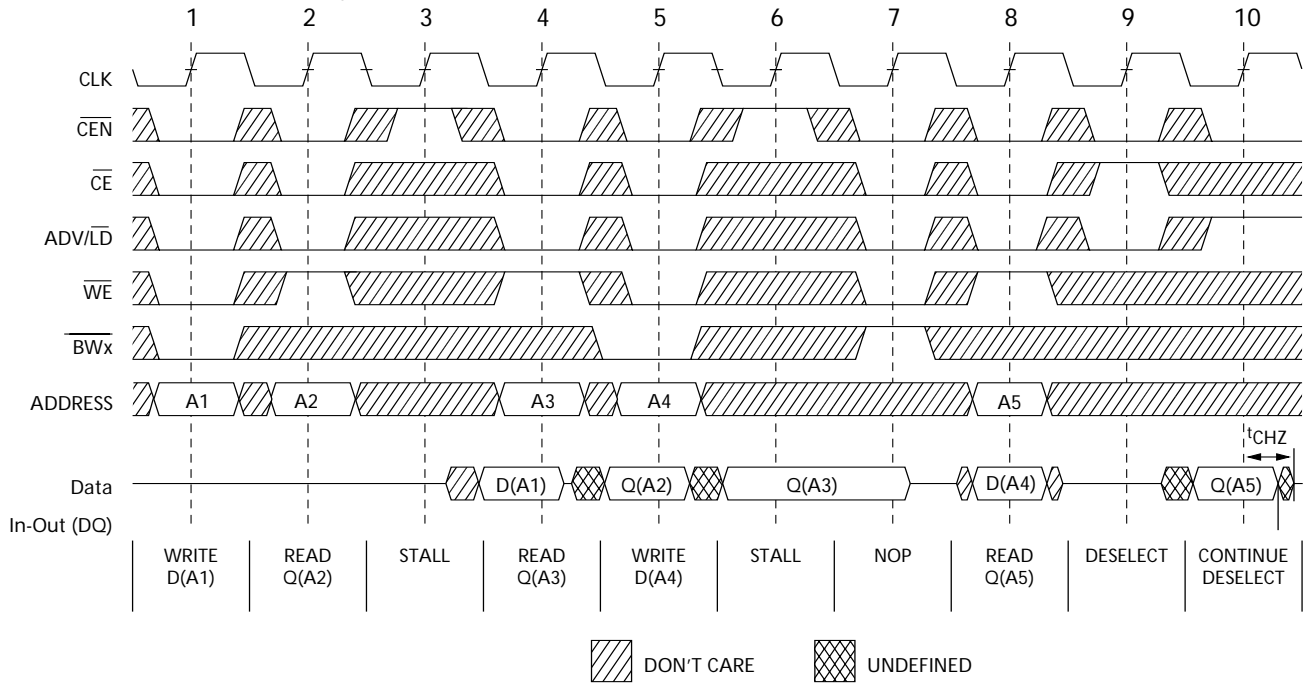
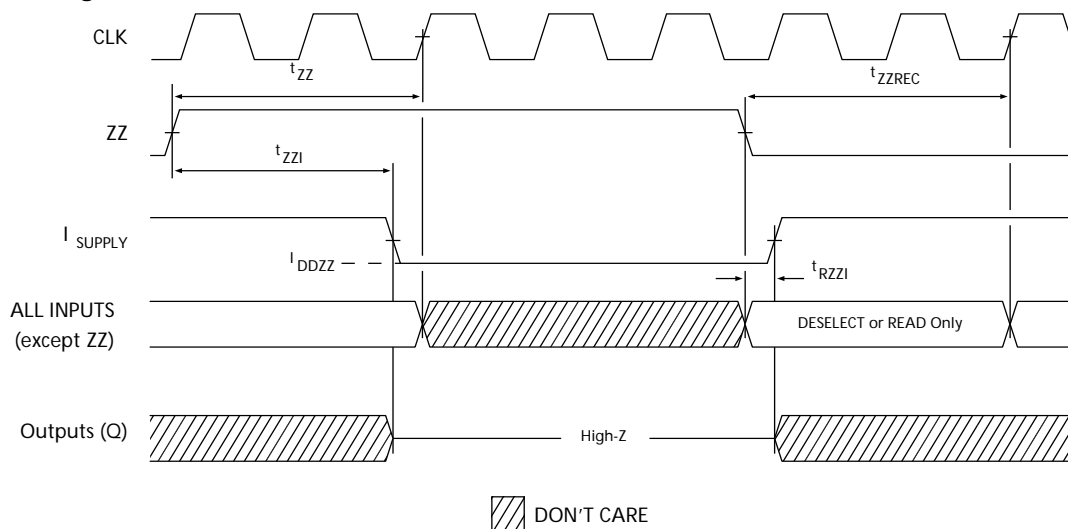
25. Order of the Burst sequence is determined by the status of the MODE (0=Linear, 1=Interleaved).Burst operations are optional.

**Switching Waveforms (continued)**
**NOP, STALL and DESELECT Cycles** <sup>[23,24,25]</sup>

**ZZ Mode Timing** <sup>[27,28]</sup>

**Ordering Information**

Speed (MHz)	Ordering Code	Package Name	Package Type	Operating Range
250	CY7C1460AV25-250AXC CY7C1462AV25-250AXC	A101	Lead-Free 100-lead Thin Quad Flat Pack (14 x 20 x 1.4 mm)	Commercial
	CY7C1460AV25-250BZC CY7C1462AV25-250BZC	BB165C	165-ball Fine Pitch Ball Grid Array (15 x 17 x 1.4 mm)	
	CY7C1464AV25-250BGC	BB209A	209-ball Ball Grid Array (14 x 22 x 1.76 mm)	
	CY7C1460AV25-250BZXC CY7C1462AV25-250BZXC	BB165C	Lead-Free 165-ball Fine Pitch Ball Grid Array (15 x 17 x 1.4 mm)	
	CY7C1464AV25-250BGXC	BB209A	Lead-Free 209-ball Ball Grid Array (14 x 22 x 1.76 mm)	
200	CY7C1460AV25-200AXC CY7C1462AV25-200AXC	A101	Lead-Free 100-lead Thin Quad Flat Pack (14 x 20 x 1.4 mm)	
	CY7C1460AV25-200BZC CY7C1462AV25-200BZC	BB165C	165-ball Fine Pitch Ball Grid Array (15 x 17 x 1.4 mm)	
	CY7C1464AV25-200BGC	BB209A	209-ball Ball Grid Array (14 x 22 x 1.76 mm)	
	CY7C1460AV25-200BZXC CY7C1462AV25-200BZXC	BB165C	Lead-Free 165-ball Fine Pitch Ball Grid Array (15 x 17 x 1.4 mm)	
	CY7C1464AV25-200BGXC	BB209A	Lead-Free 209-ball Ball Grid Array (14 x 22 x 1.76 mm)	
	167	CY7C1460AV25-167AXC CY7C1462AV25-167AXC	A101	
CY7C1460AV25-167BZC CY7C1462AV25-167BZC		BB165C	165-ball Fine Pitch Ball Grid Array (15 x 17 x 1.4 mm)	
CY7C1464AV25-167BGC		BB209A	209-ball Ball Grid Array (14 x 22 x 1.76 mm)	
CY7C1460AV25-167BZXC CY7C1462AV25-167BZXC		BB165C	Lead-Free 165-ball Fine Pitch Ball Grid Array (15 x 17 x 1.4 mm)	
CY7C1464AV25-167BGXC		BB209A	Lead-Free 209-ball Ball Grid Array (14 x 22 x 1.76 mm)	

Shaded areas contain advance information. Please contact your local Cypress sales representative for availability of these parts

**Notes:**

26. The IGNORE CLOCK EDGE or STALL cycle (Clock 3) illustrated  $\overline{\text{CEN}}$  being used to create a pause. A write is not performed during this cycle  
 27. Device must be deselected when entering ZZ mode. See cycle description table for all possible signal conditions to deselect the device.  
 28. I/Os are in High-Z when exiting ZZ sleep mode.

**Package Diagrams**

**100-pin Thin Plastic Quad Flatpack (14 x 20 x 1.4 mm) A101**

DIMENSIONS ARE IN MILLIMETERS.

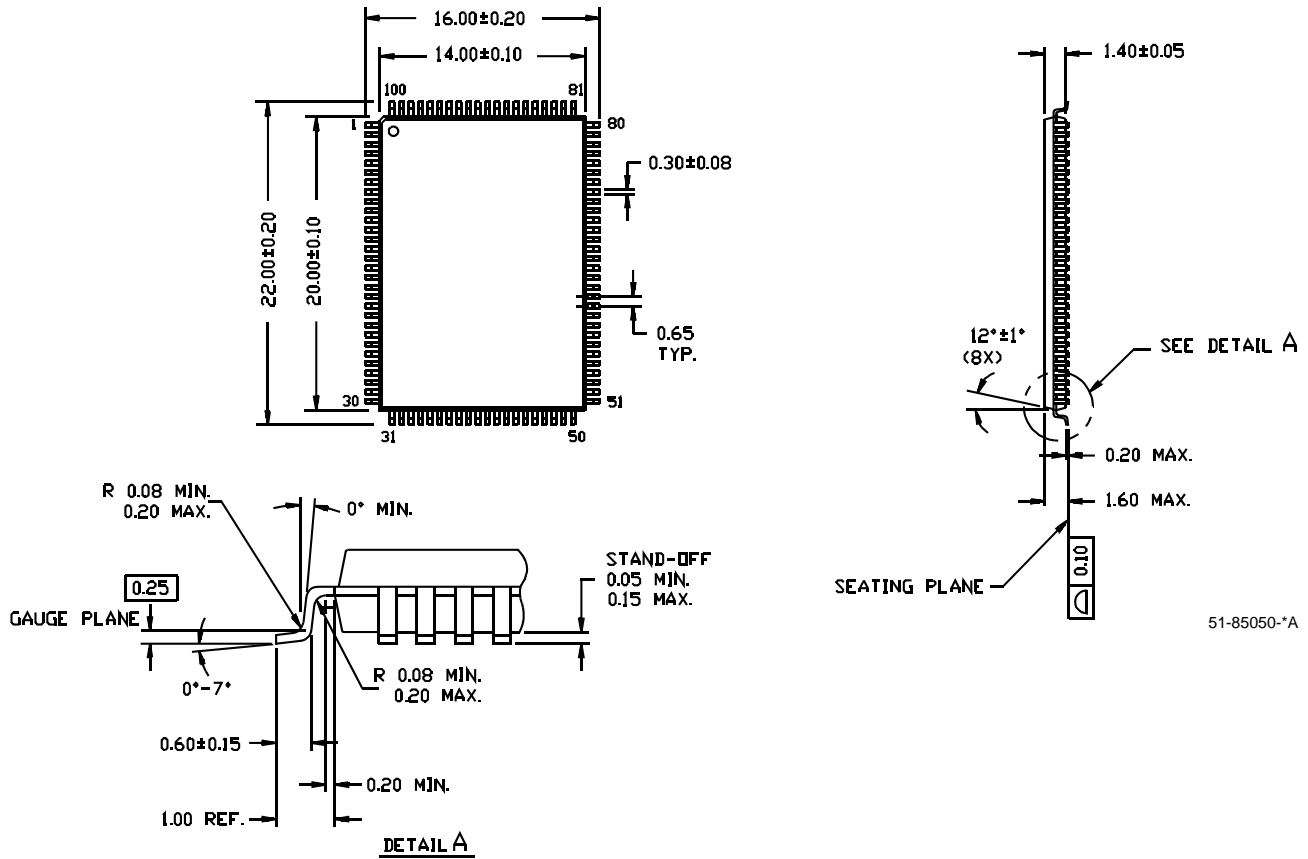

51-85050-\*A

Package Diagrams (continued)

**165-Ball FBGA (15 x 17 x 1.40 mm) BB165C**

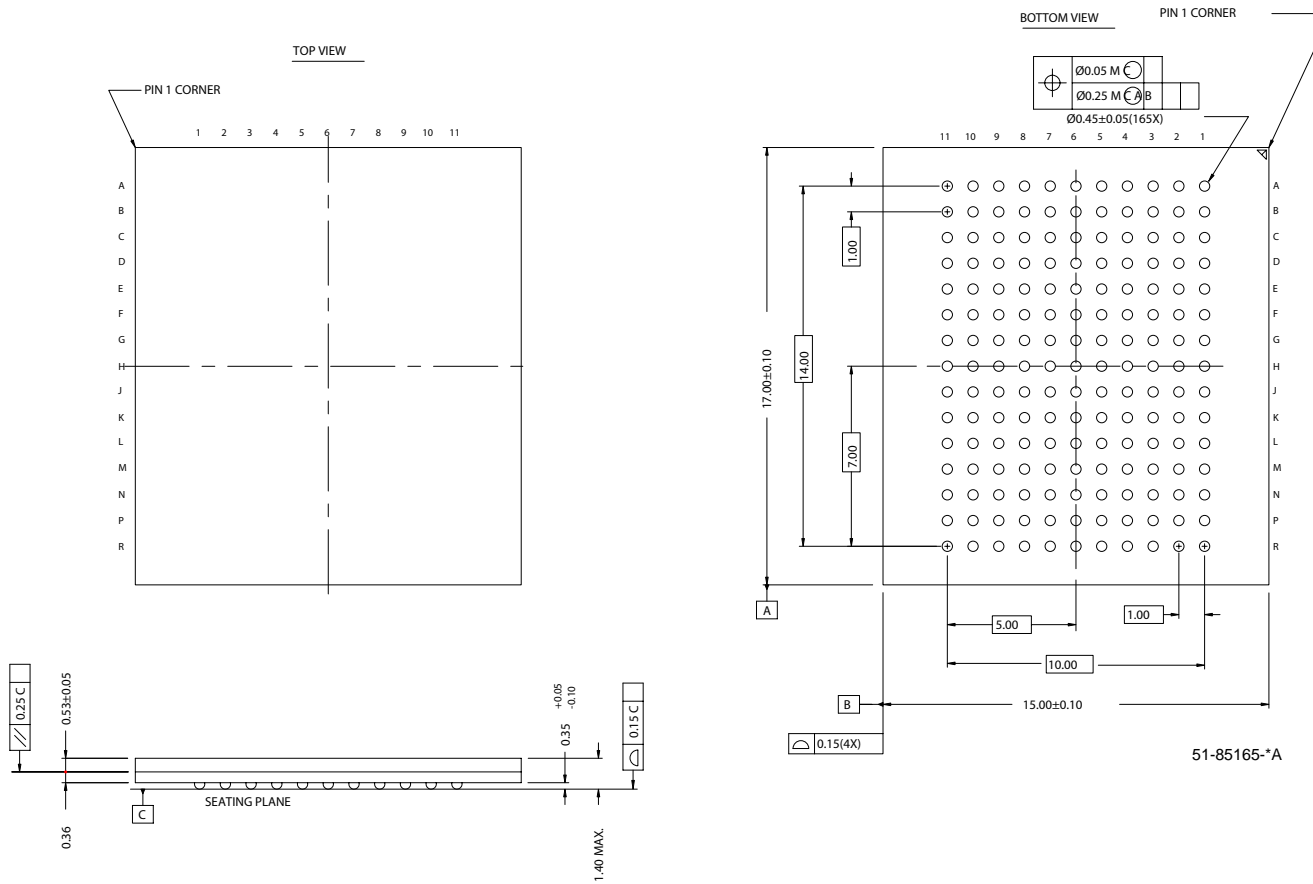

Package Diagrams (continued)

**209-Ball FBGA (14 x 22 x 1.76 mm) BB209A**

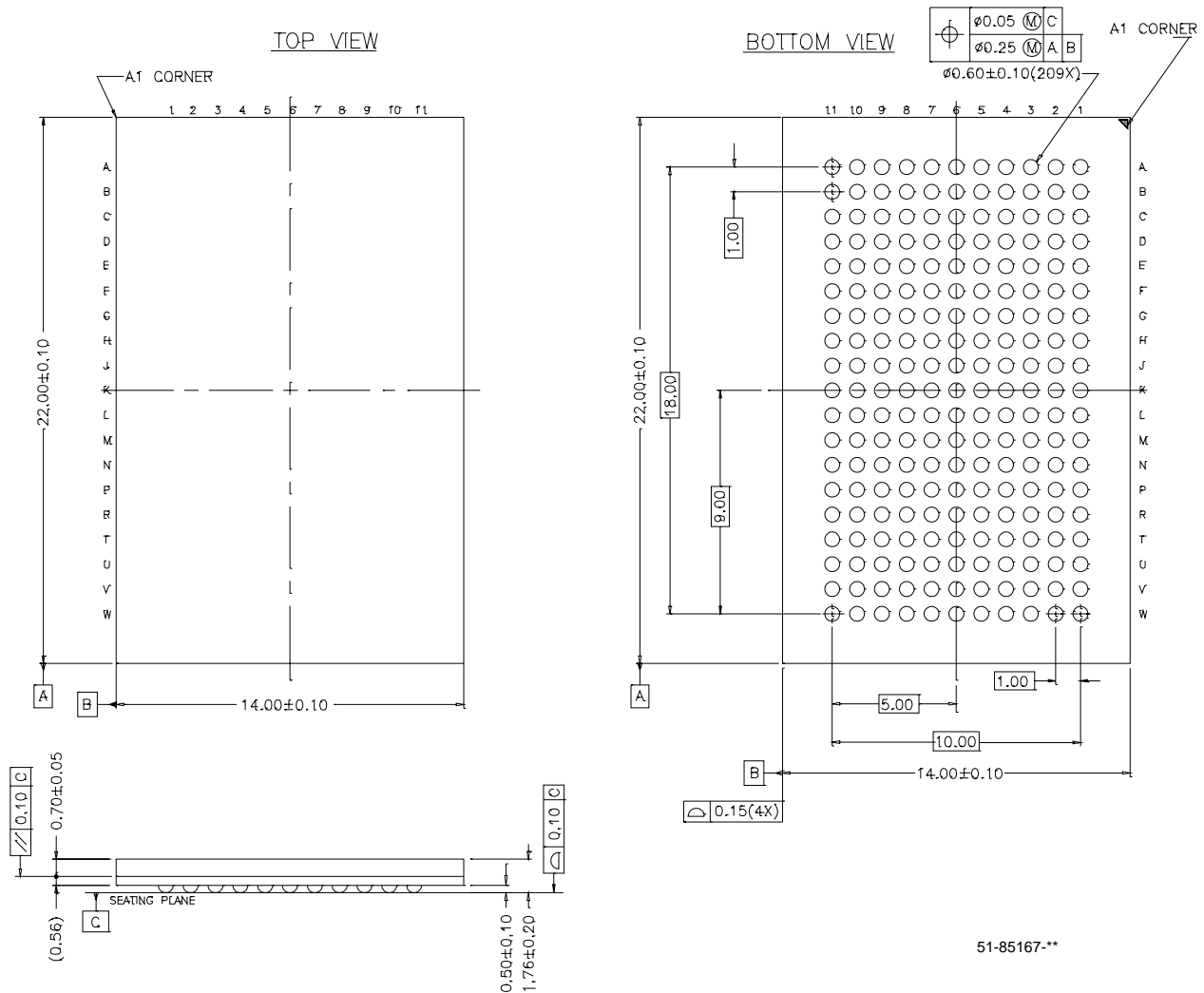

51-85167-\*\*

ZBT is a registered trademark of Integrated Device Technology. No Bus Latency and NoBL are trademarks of Cypress Semiconductor Corporation. All product and company names mentioned in this document are trademarks of their respective holders.



**Document History Page**

Document Title: CY7C1460AV25/CY7C1462AV25/CY7C1464AV25 36-Mbit (1-Mbit x 36/2-Mbit x 18/512K x 72) Pipelined SRAM with NoBL™ Architecture Document Number: 38-05354				
REV.	ECN No.	Issue Date	Orig. of Change	Description of Change
**	254911	See ECN	SYT	New data sheet Part number changed from previous revision (ew and old part number differ by the letter "A")
*A	303533	See ECN	SYT	<p>Changed H9 pin from <math>V_{SSQ}</math> to <math>V_{SS}</math> on the Pin Configuration table for 209 FBGA on Page # 5</p> <p>Changed the test condition from <math>V_{DD} = \text{Min}</math> to <math>V_{DD} = \text{Max}</math> for <math>V_{OL}</math> in the Electrical Characteristics table.</p> <p>Replaced <math>\Theta_{JA}</math> and <math>\Theta_{JC}</math> from TBD to respective Thermal Values for All Packages on the Thermal Resistance Table</p> <p>Changed <math>I_{DD}</math> from 450, 400 &amp; 350 mA to 435, 385 &amp; 335 mA for 250, 200 and 167 Mhz respectively</p> <p>Changed <math>I_{SB1}</math> from 190, 180 and 170 mA to 185 mA for 250, 200 and 167 Mhz respectively</p> <p>Changed <math>I_{SB2}</math> from 80 mA to 100 mA for all frequencies</p> <p>Changed <math>I_{SB3}</math> from 180, 170 &amp; 160 mA to 160 mA for 250, 200 and 167 Mhz respectively.</p> <p>Changed <math>I_{SB4}</math> from 100 mA to 110 mA for all frequencies</p> <p>Changed <math>C_{IN}</math>, <math>C_{CLK}</math> and <math>C_{IO}</math> to 6.5, 3 and 5.5 pF from 5, 5 and 7 pF for TQFP Package.</p> <p>Changed <math>t_{CO}</math> from 3.0 to 3.2 ns and <math>t_{DOH}</math> from 1.3 ns to 1.5 ns for 200 Mhz Speed Bin</p> <p>Added lead-free information for 100 TQFP, 165 FBGA and 209 BGA packages</p>