

PA16 • PA16A

FEATURES

- HIGH POWER BANDWIDTH — 350kHz
- HIGH SLEW RATE — 20V/ μ s
- FAST SETTLING TIME — 600ns
- LOW CROSSOVER DISTORTION — Class A/B
- LOW INTERNAL LOSSES — 1.2V at 2A
- HIGH OUTPUT CURRENT — \pm 5A PEAK
- LOW INPUT BIAS CURRENT — FET Input
- ISOLATED CASE — 300 VDC

APPLICATIONS

- MOTOR, VALVE AND ACTUATOR CONTROL
- MAGNETIC DEFLECTION CIRCUITS UP TO 5A
- POWER TRANSDUCERS UP TO 350 kHz
- AUDIO AMPLIFIERS UP TO 44W RMS

DESCRIPTION

The PA16 and PA16A are wideband, high output current operational amplifiers designed to drive resistive, inductive and capacitive loads. Their complementary “collector output” stage can swing close to the supply rails and is protected against inductive kickback. For optimum linearity, the output stage is biased for class A/B operation. The safe operating area (SOA) can be observed for all operating conditions by selection of user programmable, current limiting resistors (down to 10mA). Both amplifiers are internally compensated but are not recommended for use as unity gain followers. For continuous operation under load, mounting on a heatsink of proper rating is recommended.

These hybrid integrated circuits utilize thick film (cermet) resistors, ceramic capacitors and semiconductor chips to maximize reliability, minimize size and give top performance. Ultrasonically bonded aluminum wires provide reliable interconnections at all operating temperatures. The Power SIP package is electrically isolated.

EQUIVALENT SCHEMATIC

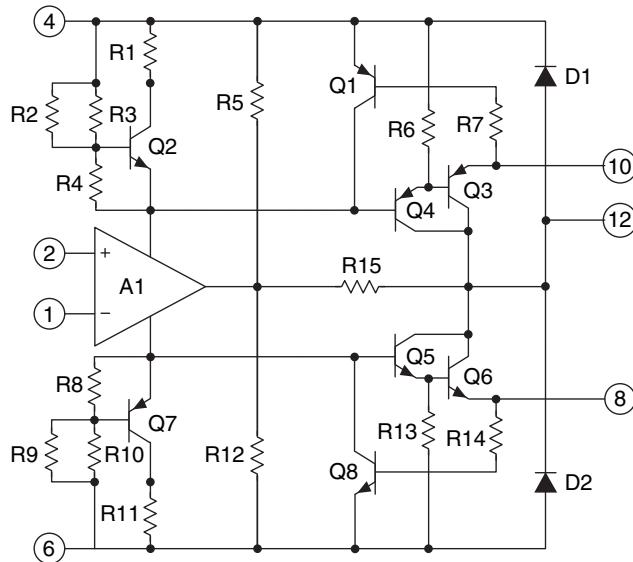

**12-PIN SIP
PACKAGE STYLE DP**

Formed leads available
See package style s ED & EE

TYPICAL APPLICATION

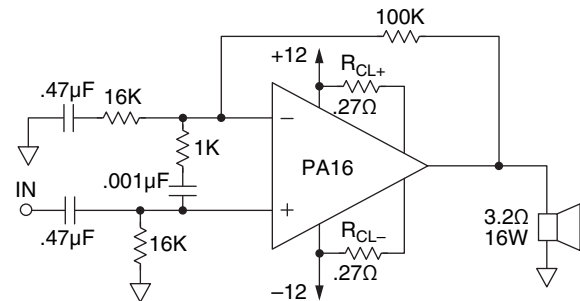

LOW INTERNAL LOSS MAXIMIZES EFFICIENCY

Vehicular Sound System Power Stage

When system voltages are low and power is at a premium, the PA16 is a natural choice. The circuit above utilizes not only the feature of low internal loss of the PA16, but also its very low distortion level to implement a crystal clear audio amplifier suitable even for airborne applications. This circuit uses AC coupling of both the input signal and the gain circuit to render DC voltage across the speaker insignificant. The resistor and capacitor across the inputs form a stability enhancement network. The 0.27 ohm current limit resistors provide protection in the event of an output short circuit.

EXTERNAL CONNECTIONS

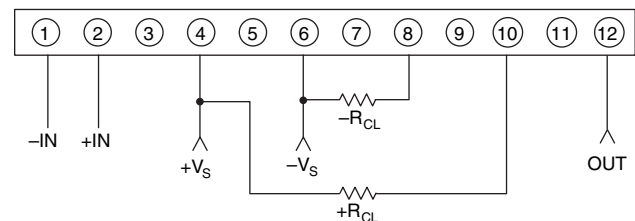

PA16 • PA16A

ABSOLUTE MAXIMUM RATINGS SPECIFICATIONS

ABSOLUTE MAXIMUM RATINGS

SUPPLY VOLTAGE, +V _S to -V _S	38V
OUTPUT CURRENT, within SOA	5A
POWER DISSIPATION, internal ¹	62.5W
INPUT VOLTAGE, differential	±V _S -5V
INPUT VOLTAGE, common mode	±V _S -2V
TEMPERATURE, pin solder - 10s max.	260°C
TEMPERATURE, junction ¹	150°C
TEMPERATURE RANGE, storage	-40 to +85°C
OPERATING TEMPERATURE RANGE, case	-25 to +85°C

SPECIFICATIONS

PARAMETER	TEST CONDITIONS ^{2,6}	PA16			PA16A			UNITS
		MIN	TYP	MAX	MIN	TYP	MAX	
INPUT								
OFFSET VOLTAGE, initial	T _C = 25°C		±5	±10		±1	±3	mV
OFFSET VOLTAGE, vs. temperature	Full temperature range		±10	±50		*	±25	μV/°C
OFFSET VOLTAGE, vs. supply	T _C = 25°C		±10			*		μV/V
OFFSET VOLTAGE, vs. power	T _C = 25°C		±6			*		μV/W
BIAS CURRENT, initial	T _C = 25°C		50	200		25	100	pA
BIAS CURRENT, vs. temperature	T _C = 85°C			200		*	*	pA/°C
BIAS CURRENT, vs. supply	T _C = 25°C		.01			*		pA/V
OFFSET CURRENT, initial	T _C = 25°C		25	100		15	50	pA
OFFSET CURRENT, vs. temperature	T _C = 85°C			100		*	*	pA/°C
INPUT IMPEDANCE, DC	T _C = 25°C		1000			*		GΩ
INPUT CAPACITANCE	T _C = 25°C		3			*		pF
COMMON MODE VOLT. RANGE ⁵ , Pos.	Full temperature range	+V _S -6	+V _S -3		*	*		V
COMMON MODE VOLT. RANGE ⁵ , Neg.	Full temperature range	-V _S +6	-V _S +5		*	*		V
COMMON MODE REJECTION, DC	Full temperature range	70	100		*	*		dB
GAIN								
OPEN LOOP GAIN at 10Hz	T _C = 25°C, 1kΩ load		103			*		dB
OPEN LOOP GAIN at 10Hz	Full temp. range, 10kΩ load	86	100		*	*		dB
GAIN BANDWIDTH PRODUCT at 1MHz	T _C = 25°C, 10Ω load		4.5			*		MHz
POWER BANDWIDTH	T _C = 25°C, 10Ω load		350			*		kHz
PHASE MARGIN	Full temp. range, 10Ω load		30			*		°
OUTPUT								
VOLTAGE SWING ³	T _C = 25°C, I _O = 5A, R _{CL} = .08Ω	±V _S -4	±V _S -3		±V _S -3	*		V
VOLTAGE SWING ³	Full temp. range, I _O = 2A	±V _S -2	±V _S -1.2		±V _S -1.2	*		V
CURRENT, peak	T _C = 25°C	5			*			A
SETTLING TIME to .1%	T _C = 25°C, 2V step		.6			*		μs
SLEW RATE	T _C = 25°C	13	20		*	*		V/μs
CAPACITIVE LOAD	Full temp. range, A _V > 10		SOA			*		
HARMONIC DISTORTION	P _O = 5W, F = 1kHz, R _L = 4Ω		.028			*		%
SMALL SIGNAL rise/fall time	R _L = 10Ω, A _V = 1		100			*		ns
SMALL SIGNAL overshoot	R _L = 10Ω, A _V = 1		10			*		%
POWER SUPPLY								
VOLTAGE	Full temperature range	±7	±15	±19	*	*	*	V
CURRENT, quiescent	T _C = 25°C		27	40		*	*	mA
THERMAL								
RESISTANCE, AC junction to case ⁴	F > 60Hz		1.4	1.6		*	*	°C/W
RESISTANCE, DC junction to case	F < 60Hz		1.8	2.0		*	*	°C/W
RESISTANCE, junction to air			30			*		°C/W
TEMPERATURE RANGE, case	Meets full range specifications	-25		+85	*		*	°C

NOTES: * The specification of PA16A is identical to the specification for PA16 in applicable column to the left.

1. Long term operation at the maximum junction temperature will result in reduced product life. Derate internal power dissipation to achieve high MTTF.
2. The power supply voltage for all specifications is the TYP rating unless otherwise noted as a test condition.
3. +V_S and -V_S denote the positive and negative supply rail respectively. Total V_S is measured from +V_S to -V_S.
4. Rating applies if the output current alternates between both output transistors at a rate faster than 60Hz.
5. Exceeding CMV range can cause the output to latch.
6. Full temperature specifications are guaranteed but not 100% tested.

CAUTION

The exposed substrate contains beryllia (BeO). Do not crush, machine, or subject to temperatures in excess of 850°C to avoid generating toxic fumes.

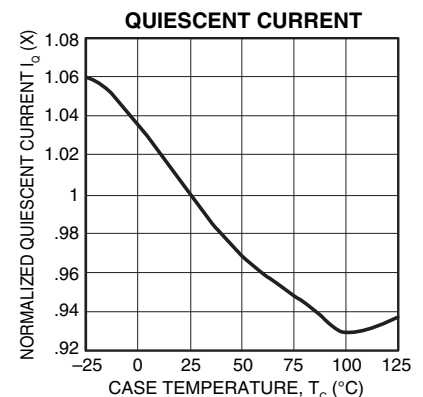
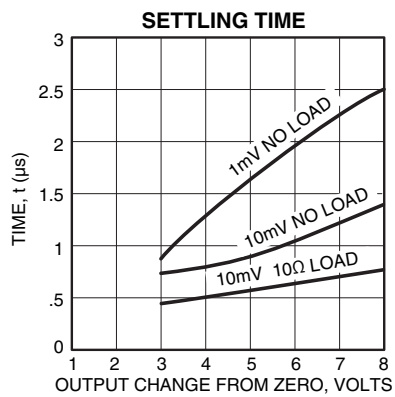
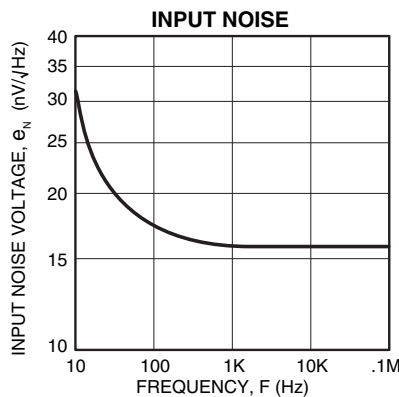
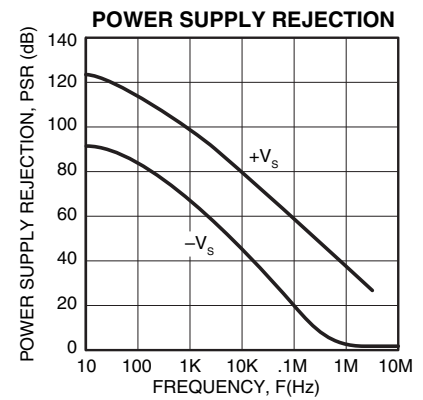
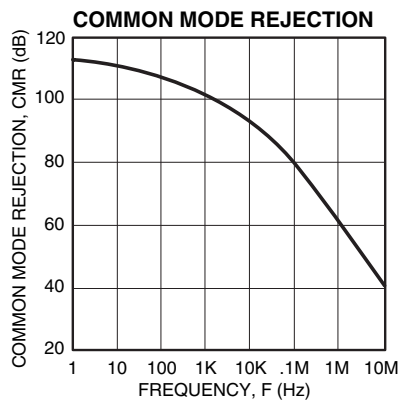
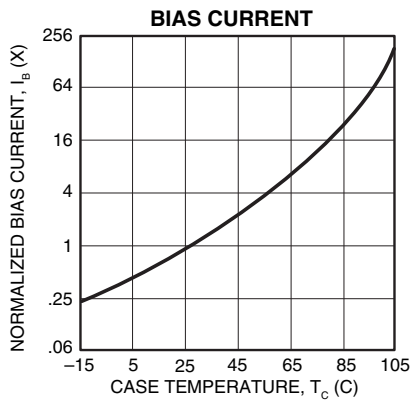
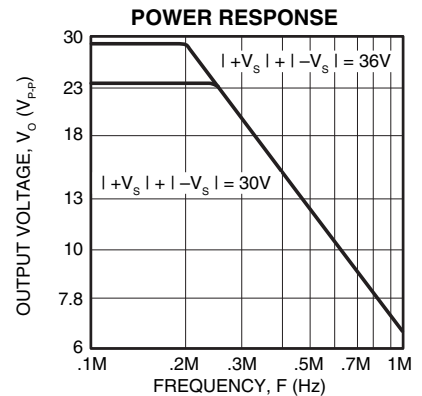
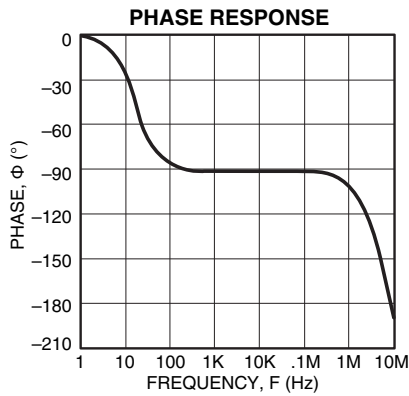
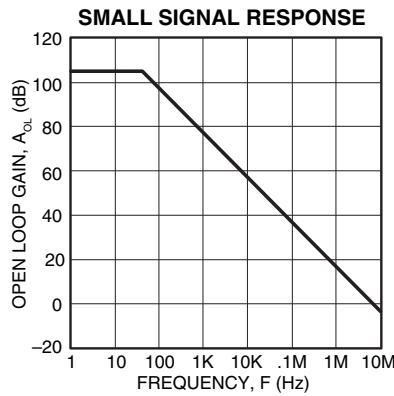
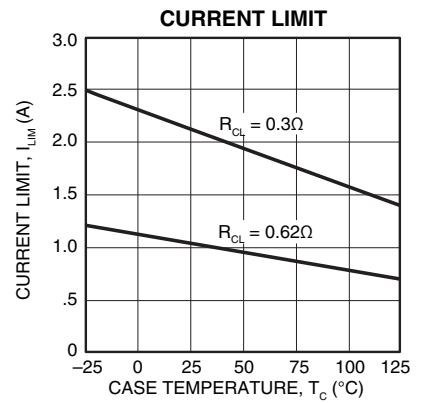
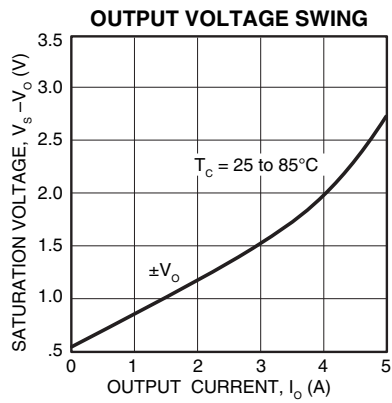
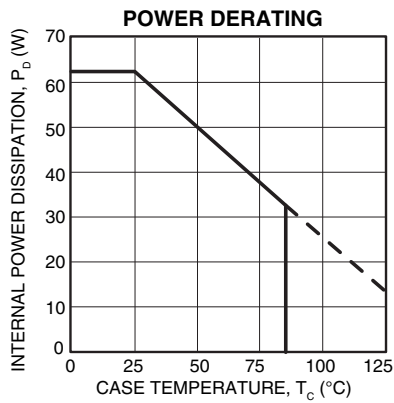

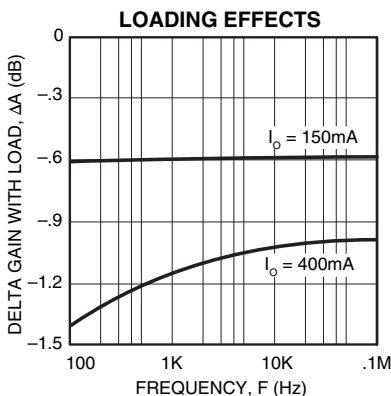
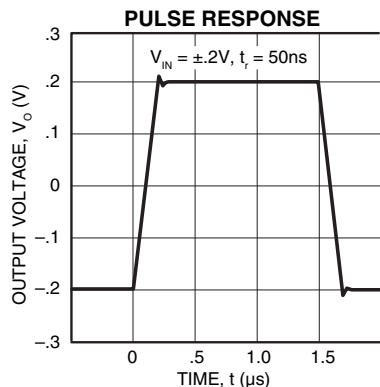
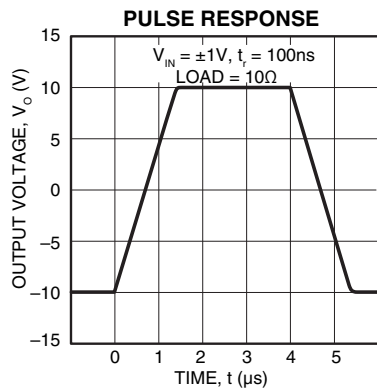
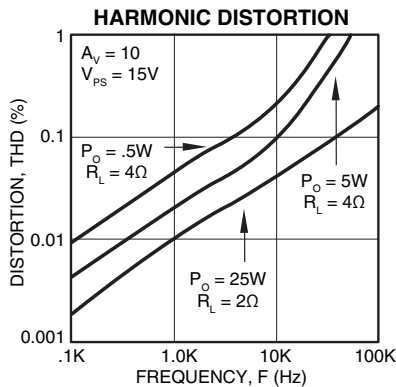

GENERAL

Please read Application Note 1 "General Operating Considerations" which covers stability, supplies, heat sinking, mounting, current limit, SOA interpretation, and specification interpretation. Visit www.apexmicrotech.com for design tools that help automate tasks such as calculations for stability, internal power dissipation, current limit; heat sink selection; Apex's complete Application Notes library; Technical Seminar Workbook; and Evaluation Kits.

SAFE OPERATING AREA (SOA)

The SOA curves combine the effect of all limits for this Power Op Amp. For a given application, the direction and magnitude of the output current should be calculated or measured and checked against the SOA curves. This is simple for resistive loads but more complex for reactive and EMF generating loads. The following guidelines may save extensive analytical efforts:

The amplifier can handle any EMF generating or reactive load and short circuits to the supply rails or shorts to common if the current limits are set as follows at $T_c = 85^\circ C$.

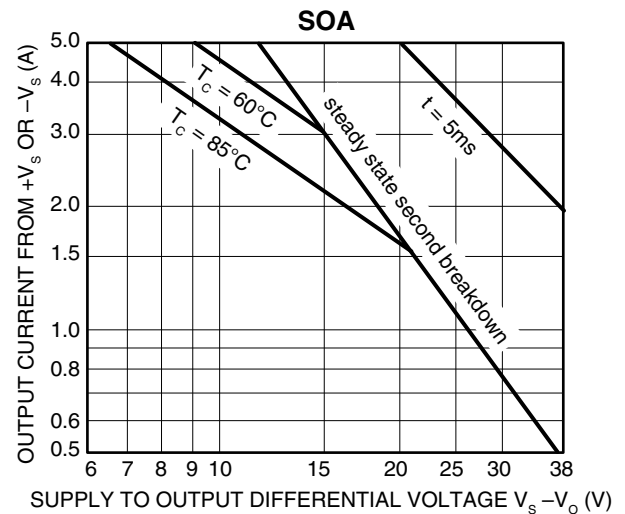

$\pm V_s$	SHORT TO $\pm V_s$ C, L OR EMF LOAD	SHORT TO COMMON
18V	.9A	1.8A
15V	1.0A	2.1A
10V	1.6A	3.2A

These simplified limits may be exceeded with further analysis using the operating conditions for a specific application.

CURRENT LIMIT

Proper operation requires the use of two current limit resistors, connected as shown in the external connection diagram. The minimum value for R_{CL} is 0.12 ohm, however for optimum reliability it should be set as high as possible. Refer to the "General Operating Considerations" section of the handbook for current limit adjust details.

$$R_{CL} = \frac{.65}{I_{LIM} (A)} - 0.01$$

DEVICE MOUNTING

The case (mounting flange) is electrically isolated and should be mounted directly to a heatsink with thermal compound. Screws with Belleville spring washers are recommended to maintain positive clamping pressure on heatsink mounting surfaces. Long periods of thermal cycling can loosen mounting screws and increase thermal resistance.

Since the case is electrically isolated (floating) with respect to the internal circuits it is recommended to connect it to common or other convenient AC ground potential.