

Technical Data Sheet

Photo link Light Receiver Unit

PLR253 Series

Features

1. High speed signal transmission (25Mbps NRZ Signal)
2. High PD sensitivity optimized for red light
3. Data : NRZ signal
4. Low power consumption for extended battery life
5. Built-in threshold control for improved noise Margin
6. Good ESD protection: up to 8KV
7. Pb Free
8. The product itself will remain within RoHS compliant version.
9. Receiver sensitivity: up to -28dBm (Min. for 16Mbps)
up to -26dBm (Min. for 25Mbps)



Descriptions

The optical receiver is packaged with custom optic data link interface, integrated on a proprietary CMOS PDIC process.

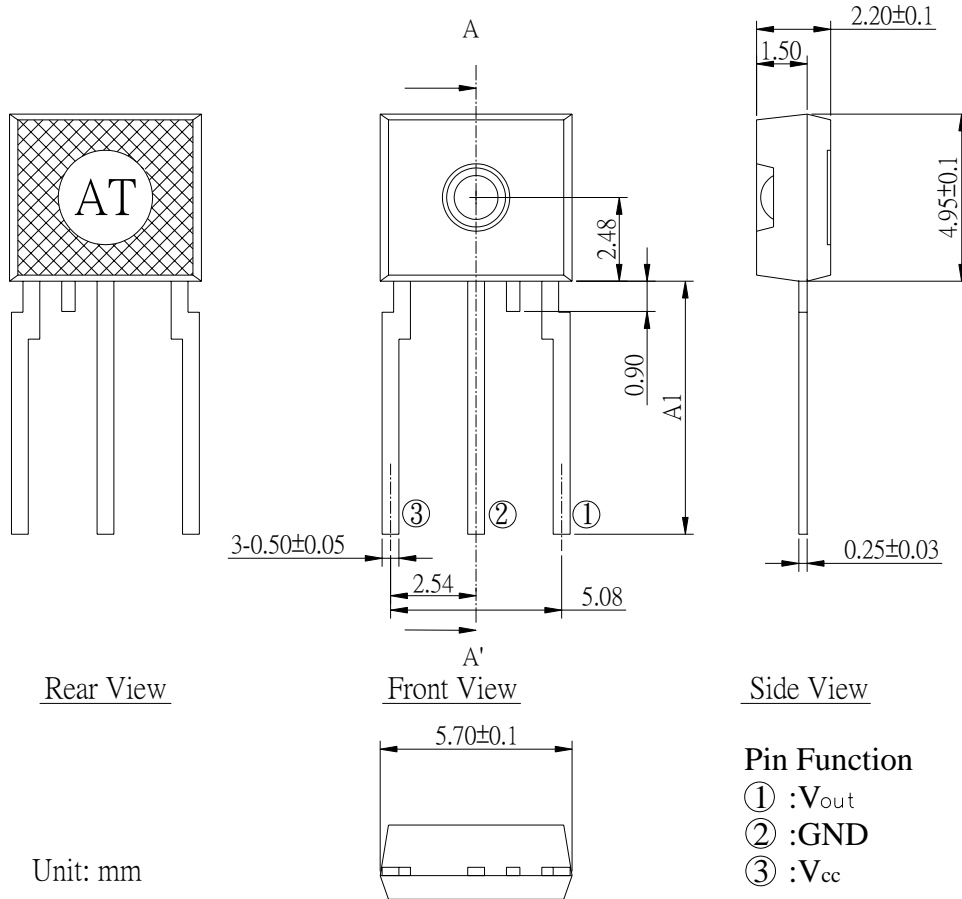
The unit functions by converting optical signals into electric ones.

The unit is operated at 2.4 ~ 5.5 V and the signal output interface is TTL compatible with high performance at low power consumption.

Applications

1. Digital Optical Data-Link
2. Dolby AC-3 Digital Audio Interface
3. HDMI Digital (192kHz) Audio Interface

Package Dimensions



- Notes:**
- 1.All dimensions are in mm.
 - 2.General Tolerance: Tolerance is ± 0.20 mm
 - 3.Plating Thickness: Tin Layer $> 2\mu\text{m}$
 - 4.It must be placed a $0.1\mu\text{F}$ capacitor in the between of V_{cc} and GND within 7mm.
 - 5.Device Selection Table:

Device Name	Pin Length A1 (mm)
PLR253	12.55 ± 0.5
PLR253/S1	7.50 ± 0.25
PLR253/S5	16.50 Min

Absolute Maximum Ratings(Ta = 25 °C)

Parameter	Symbol	Rating	Unit
Supply Voltage	Vcc	-0.5 ~ +6.0	V
Output Voltage	Vout	Vcc -0.1	V
Storage Temperature	Tstg	-40 to 85	°C
Operating Temperature	Topr	-25 to 80	°C
Soldering Temperature	Tsol	260*	°C

* Soldering time ≤ 10 s.

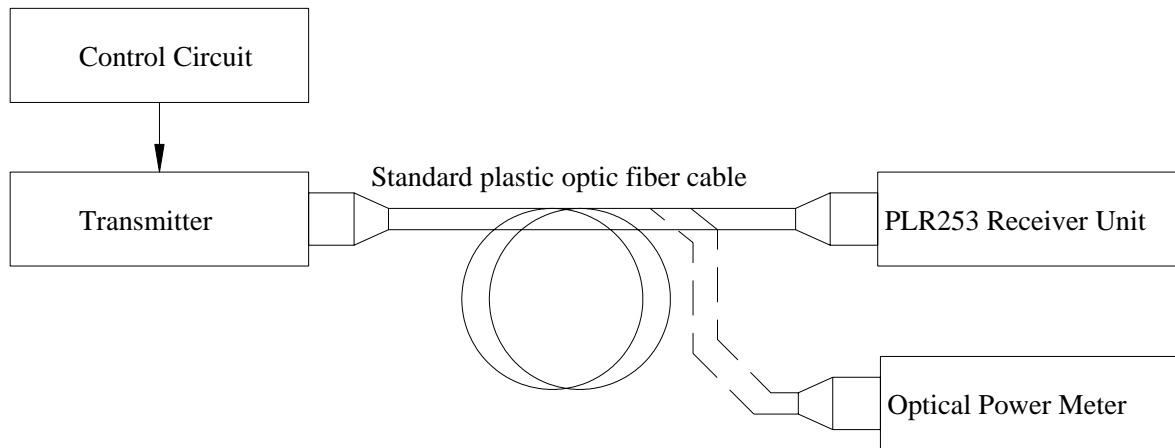
Electro-Optical Characteristics(Ta=-20~70°C, Vcc=3.3V)

Parameter	Symbol	Conditions	MIN.	TYP.	MAX.	Unit
Power supply voltage	Vcc	-	2.40	3.30	5.50	V
Peak sensitivity wavelength	λ_p	-	-	660	-	nm
Maximum receiver power	Pc,max	Refer to Fig.1	-	-	-14	dBm
Minimum receiver power	Pc,min	Refer to Fig.1	-26	-	-	dBm
Dissipation current	Icc	Vcc=3V; Refer to Fig.2	-	2	4	mA
		Vcc=5V; Refer to Fig.2	-	3	6	mA
High level output voltage	VOH	Refer to Fig.3	3.0	3.2	-	V
Low level output voltage	VOL	Refer to Fig.3	-	0.2	0.4	V
Rise time	tr	Refer to Fig.3	-	10	14	ns
Fall time	tf	Refer to Fig.3	-	10	14	ns
Propagation delay Low to High	t _{PLH}	Refer to Fig.3	-	-	80	ns
Propagation delay High to Low	t _{PHL}	Refer to Fig.3	-	-	80	ns
Pulse Width Distortion	Δtw	Refer to Fig.3	-15	-	+15	ns
Jitter	Δtj	Refer to Fig.3, Pc=-14dBm	-	1	5	ns
		Refer to Fig.3, Pc=-26dBm	-	5	10	ns
Transfer rate	T	NRZ signal	0.1	-	25	Mb/s

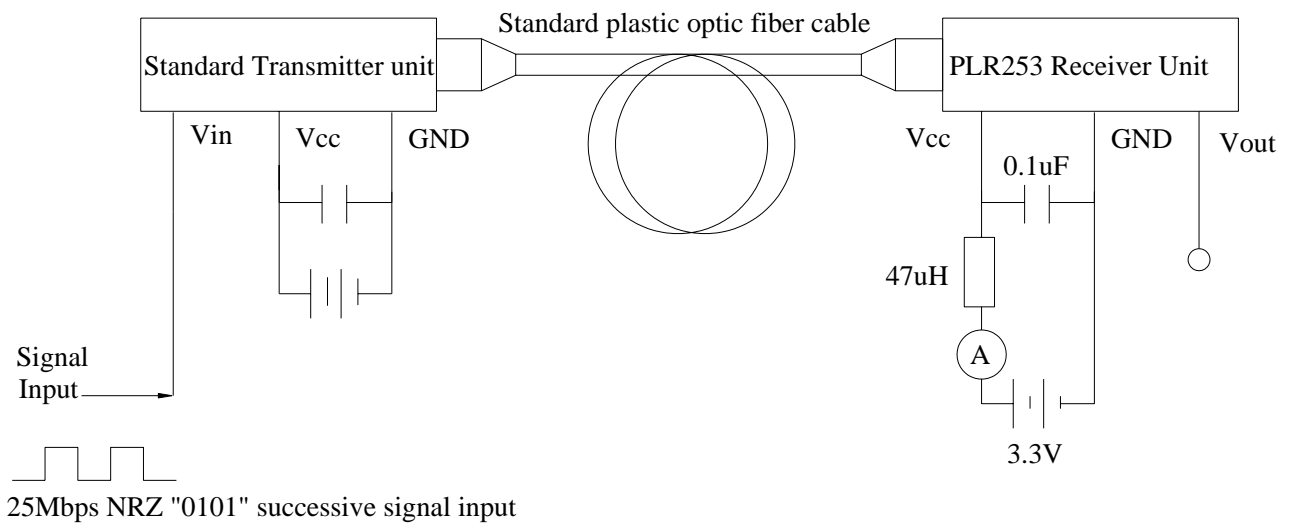
*Standard plastic optic fiber cable : 1m

Measuring Method

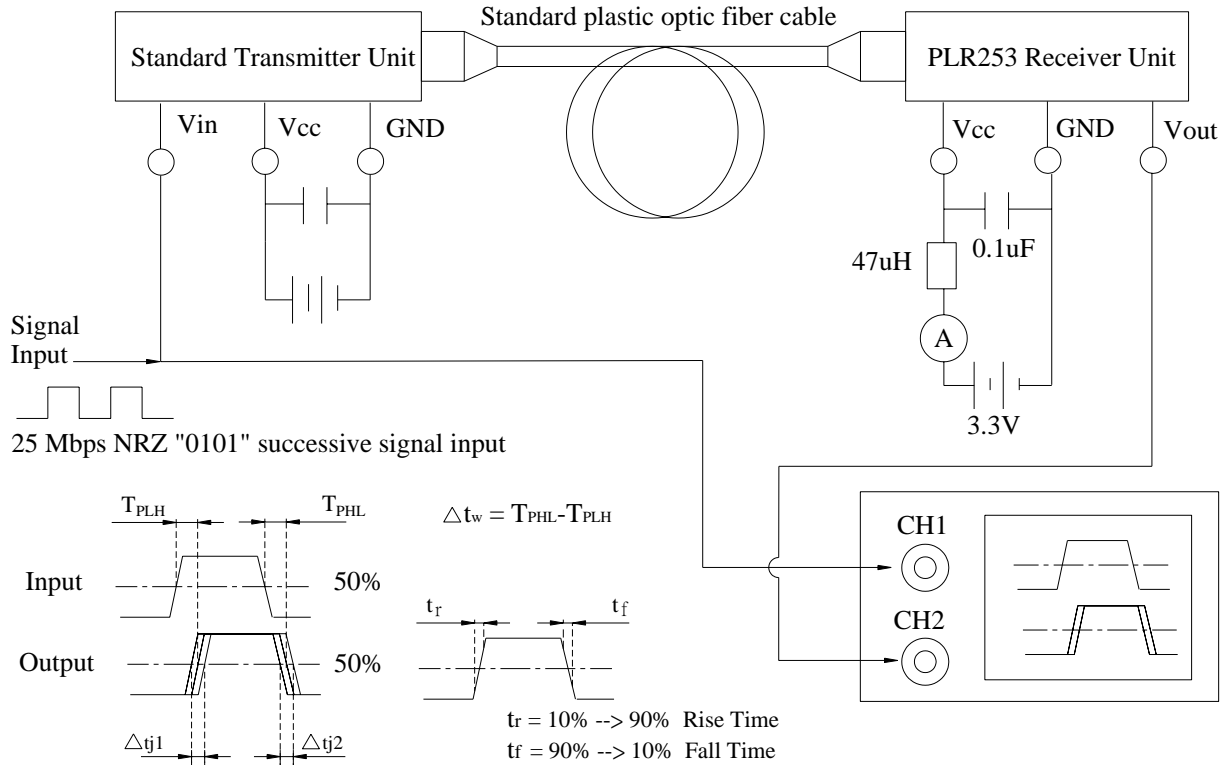
*Fig.1 Measuring Method of Maximum and Minimum Input Power that Receiver Unit Need



*Fig.2 Measuring Method of Dissipation Current

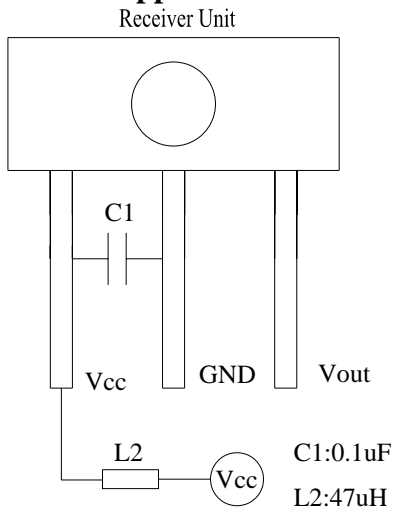


*Fig.3 Measuring Method of Output Voltage, Pulse and Jitter



Application Circuit

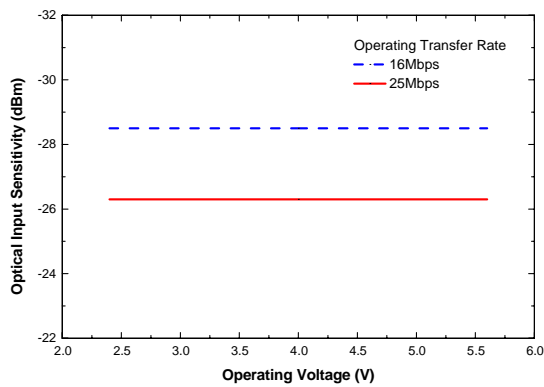
(1) General application circuit



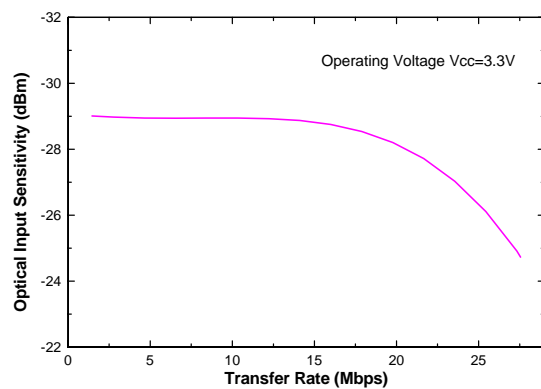
- Note:**
1. For having good coupling, the C1 capacitor must be placed within 7mm
 2. For having good signal waveform, the V_{out}-GND circuit capacitor shall be smaller than 30pF.

Typical Electro-Optical Characteristics Curves

*Fig.4 Power supply voltage vs. Minimum receiver power



*Fig.5 Transfer rate vs. Minimum receiver power

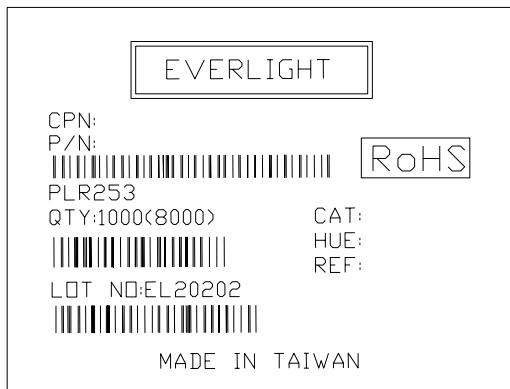


Note: Before using the PLR253 device, please confirm the minimum sensitivity at different operating voltage and transmission rate.

Packing Quantity Specification

- 1. 1000 pcs/bag
- 2. 8 bag/box

Label Form Specification



CPN: Customer's Production Number

P/N : Production Number

QTY: Packing Quantity

CAT: Ranks

HUE: None

REF: Reference

LOT No: Lot Number

MADE IN TAIWAN: Production Place

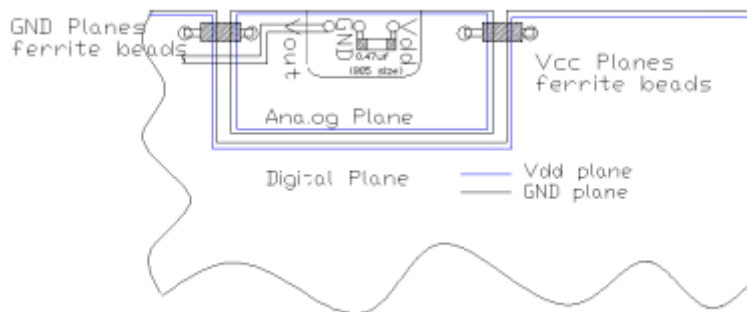
Notes

- 1. Above specification may be changed without notice. EVERLIGHT will reserve authority on material change for above specification.
- 2. When using this product, please observe the absolute maximum ratings and the instructions for using outlined in these specification sheets. EVERLIGHT assumes no responsibility for any damage resulting from use of the product that does not comply with the absolute maximum ratings and the instructions included in these specification sheets.
- 3. These specification sheets include materials protected under copyright of EVERLIGHT Corporation. Please don't reproduce or cause anyone to reproduce them without EVERLIGHT's consent.

Application Notes: PLR253 Series PCB layout for motherboard integration

To achieve better jitter and low input optical power performances, several PCB layout guidelines must be followed. These guidelines ensure the most reliable PLR253 POF performance for the motherboard integration. Failed to implement these PCB guidelines may affect the PLR253 jitter and low input power performances.

1. Careful decoupling of the power supplies is very important. Place a 0.1uF surface mount (size 805 or smaller) capacitor as close as (less than 2cm) to the POF Vdd and Gnd leads. The 0.1uF act as a low impedance path to ground for any stray high frequency transient noises.
2. To reduce the digital noises form the digital IC on the motherboard, the planar capacitance formed by an isolated Vcc and Gnd planes is critical. The POF device must be mounted directly on these two planes to reduce the lead parasitic inductance.
3. The isolated Vdd and Gnd planes must be connected to the main Vcc and Gnd (digital) planes at a single point using ferrite beads. The beads are used to block the high frequency noises from the digital planes while still allowing the DC connections between the planes



EVERLIGHT ELECTRONICS CO., LTD.
 Office: No 25, Lane 76, Sec 3, Chung Yang Rd,
 Tucheng, Taipei 236, Taiwan, R.O.C

Tel: 886-2-2267-2000, 2267-9936
 Fax: 886-2-2269-8114, 2267-6189, 2267-6306
<http://www.everlight.com>