

LOW NOISE 200mA LDO REGULATOR

NO.EA-140-070831

OUTLINE

The RP100x Series are CMOS-based voltage regulator ICs with high output voltage accuracy, extremely low supply current, low ON-resistance, and high ripple rejection. Each of these ICs consists of a voltage reference unit, an error amplifier, resistor-net for voltage setting, a current limit circuit, and a chip enable circuit.

These ICs perform with low dropout voltage and a chip enable function. The line transient response and load transient response of the RP100x Series are excellent, thus these ICs are very suitable for the power supply for hand-held communication equipment.

The output voltage of these ICs is fixed with high accuracy. Since the packages for these ICs are SOT-23-5 and PLP1612-4, therefore high density mounting of the ICs on boards is possible.

FEATURES

- Supply Current Typ. 18 μ A
- Standby Current Typ. 0.1 μ A
- Dropout Voltage Typ. 0.13V ($I_{OUT}=150mA$, $V_{OUT}=2.8V$)
- Ripple Rejection Typ. 75dB ($f=1kHz$)
- Temperature-Drift Coefficient of Output Voltage ... Typ. $\pm 30ppm/^{\circ}C$
- Line Regulation Typ. 0.02%/V
- Output Voltage Accuracy $\pm 0.8\%$
- Packages PLP1612-4, SOT-23-5
- Input Voltage Range 1.7V to 5.25V
- Output Voltage 1.2V, 1.3V, 1.5V, 1.8V, 1.85V, 1.9V, 2.0V, 2.1V, 2.5V,
2.6V, 2.7V, 2.8V, 2.85V, 2.9V, 3.0V, 3.1V, 3.3V
- Built-in Fold Back Protection Circuit Typ. 40mA (Current at short mode)
- Ceramic capacitors are recommended to be used with this IC 1.0 μ F or more

APPLICATIONS

- Power source for portable communication equipment.
- Power source for electrical appliances such as cameras, VCRs and camcorders.
- Power source for battery-powered equipment.

RP100x

BLOCK DIAGRAMS

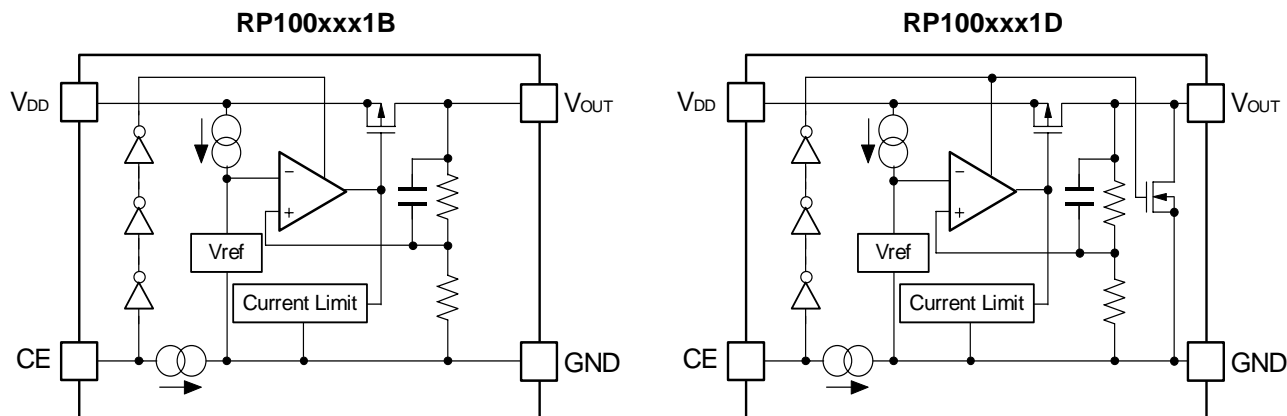

SELECTION GUIDE

The output voltage, auto discharge function*, and the taping type for the ICs can be selected at the user's request.

The selection can be made with designating the part number as shown below;

RP100xxx1x-xx-x ← Part Number
 ↑ ↑ ↑ ↑ ↑
 a b c d e

Code	Contents
a	Designation of Package Type: K: PLP1612-4 N: SOT-23-5
b	Setting Output Voltage (V_{OUT}): The following 16 kinds of voltage are standard. 1.2V, 1.3V, 1.5V, 1.8V, 1.85V, 1.9V, 2.0V, 2.1V, 2.5V, 2.6V, 2.7V, 2.8V, 2.85V, 2.9V, 3.0V, 3.1V, 3.3V Exceptions: 1.85V=RP100x181x5-xx-x, 2.85V=RP100x281x5-xx-x
c	Designation of Mask Option B: active high, without auto discharge function* at OFF state. D: active high, with auto discharge function* at OFF state.
d	Designation of Taping Type: Ex. TR (refer to Taping Specifications; TR type is the standard direction.)
e	Designation of composition of pin plating: -F: Lead free plating (SOT-23-5) None: Au plating (PLP1612-4)

*) When the mode is into standby with CE signal, auto discharge transistor turns on, and it makes the turn-off speed faster than normal type.

PIN CONFIGURATIONS

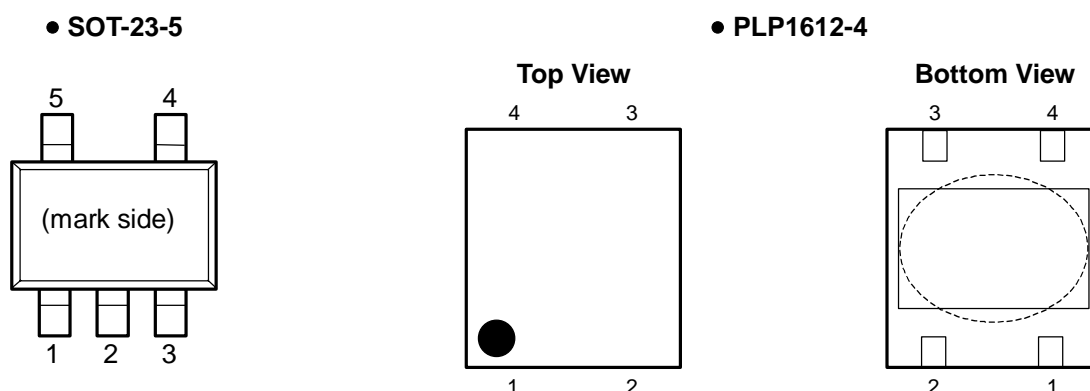

PIN DESCRIPTIONS

• SOT-23-5

Pin No.	Symbol	Description
1	V _{DD}	Input Pin
2	GND	Ground Pin
3	CE	Chip Enable Pin ("H" Active)
4	NC	No Connection
5	V _{OUT}	Output Pin

• PLP1612-4*

Pin No.	Symbol	Description
1	V _{OUT}	Output Pin
2	GND	Ground Pin
3	CE	Chip Enable Pin ("H" Active)
4	V _{DD}	Input Pin

*) Tab in the  parts have GND level.
(They are connected to the back side of this IC.)
Do not connect to other wires or land patterns.

ABSOLUTE MAXIMUM RATINGS

Symbol	Item	Rating	Unit
V _{IN}	Input Voltage	6.0	V
V _{CE}	Input Voltage (CE Pin)	6.0	V
V _{OUT}	Output Voltage	-0.3 to V _{IN} +0.3	V
I _{OUT}	Output Current	300	mA
P _D	Power Dissipation (SOT-23-5) *1	420	mW
	Power Dissipation (PLP1612-4) *1	610	
T _{opt}	Operating Temperature Range	-40 to 85	°C
T _{stg}	Storage Temperature Range	-55 to 125	°C

*1) For Power Dissipation, please refer to PACKAGE INFORMATION to be described.

RP100x**ELECTRICAL CHARACTERISTICS**● **RP100xxx1B/D**

$V_{IN} = \text{Set } V_{OUT} + 1V$, $I_{OUT} = 1mA$, $C_{IN} = C_{OUT} = 1\mu F$, unless otherwise noted.

$T_{opt} = 25^{\circ}C$

Symbol	Item	Conditions	Min.	Typ.	Max.	Unit	
V_{OUT}	Output Voltage	$V_{IN} = \text{Set } V_{OUT} + 1V$ $I_{OUT} = 1mA$	$V_{OUT} > 2.0V$	$\times 0.992$		$\times 1.008$	V
			$V_{OUT} \leq 2.0V$	-16		+16	mV
I_{OUT}	Output Current		200			mA	
$\frac{\Delta V_{OUT}}{\Delta I_{OUT}}$	Load Regulation	$1mA \leq I_{OUT} \leq 150mA$		20	40	mV	
V_{DIF}	Dropout Voltage	$I_{OUT} = 150mA$	$1.2V \leq V_{OUT} < 1.5V$		0.40	0.50	V
			$1.5V \leq V_{OUT} < 1.7V$		0.24	0.38	
			$1.7V \leq V_{OUT} < 2.0V$		0.21	0.34	
			$2.0V \leq V_{OUT} < 2.5V$		0.17	0.30	
			$2.5V \leq V_{OUT} < 2.8V$		0.14	0.25	
			$2.8V \leq V_{OUT} \leq 3.3V$		0.13	0.23	
I_{SS}	Supply Current	$I_{OUT} = 0mA$		18	25	μA	
$I_{standby}$	Standby Current	$V_{CE} = 0V$		0.1	2.0	μA	
$\frac{\Delta V_{OUT}}{\Delta V_{IN}}$	Line Regulation	$\text{Set } V_{OUT} + 0.5V \leq V_{IN} \leq 5.0V$		0.02	0.10	%/V	
RR	Ripple Rejection	$f = 1kHz$, Ripple 0.2Vp-p $V_{IN} = \text{Set } V_{OUT} + 1V$, $I_{OUT} = 30mA$ (In case that $V_{OUT} \leq 2.0V$, $V_{IN} = 3V$)		75		dB	
V_{IN}	Input Voltage*1		1.7		5.25	V	
$\frac{\Delta V_{OUT}}{\Delta T_{opt}}$	Output Voltage Temperature Coefficient	$-40^{\circ}C \leq T_{opt} \leq 85^{\circ}C$		± 30		ppm/ $^{\circ}C$	
I_{lim}	Short Current Limit	$V_{OUT} = 0V$		40		mA	
I_{PD}	CE Pull-down Current			0.3		μA	
V_{CEH}	CE Input Voltage "H"		1.5			V	
V_{CEL}	CE Input Voltage "L"				0.3	V	
en	Output Noise	$BW = 10Hz$ to $100kHz$ $I_{OUT} = 30mA$		30		μV_{rms}	
R_{LOW}	Low Output Nch Tr. ON Resistance (of D version)	$V_{IN} = 4.0V$, $V_{CE} = 0V$		30		Ω	

*1) Max. Input Voltage is 5.5V during 500hours.

TYPICAL APPLICATION

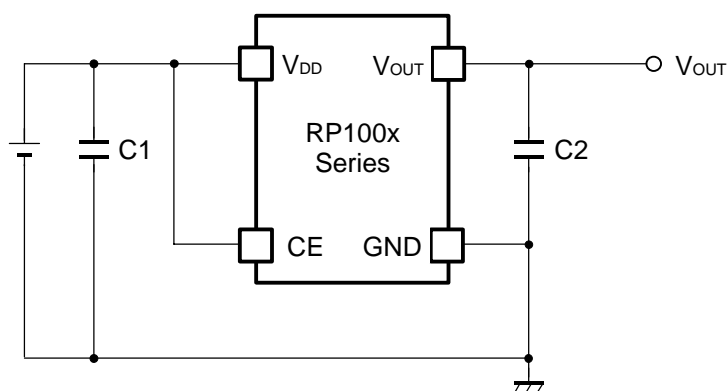

(External Components)

C2 1.0 μ F MURATA: GRM155B31A105KE15

TECHNICAL NOTES

When using these ICs, consider the following points:

Phase Compensation

In these ICs, phase compensation is made for securing stable operation even if the load current is varied. For this purpose, use a capacitor C2 with good frequency characteristics and ESR (Equivalent Series Resistance).

Ceramic capacitors have different temperature characteristics and bias characteristics depending on their dimensions and manufacturers. If the setting voltage is 2.5V or more and the capacitor's dimensions for V_{OUT} equal to 1.0mm by 0.5mm or smaller than that, the capacitance value might be extremely low. As a result, the capacitance might be much less than expected value. In such cases, the operation might be unstable at low temperature. (-20°C or less) In that case, use a larger capacity, or a large dimensions' capacitor. (For example 1.6mm by 0.8mm)

If a tantalum capacitor is selected as an output capacitor, large ESR may be a cause of unstable operation. Evaluate the operation of PCB with considerable frequency characteristics.

PCB Layout

Make V_{DD} and GND lines sufficient. If their impedance is high, noise pickup or unstable operation may result. Connect a capacitor C1 with a capacitance value as much as 1.0 μ F or more between V_{DD} and GND pin, and as close as possible to the pins.

Set external components, especially the output capacitor C2, as close as possible to the ICs, and make wiring as short as possible.

RP100x

TEST CIRCUITS

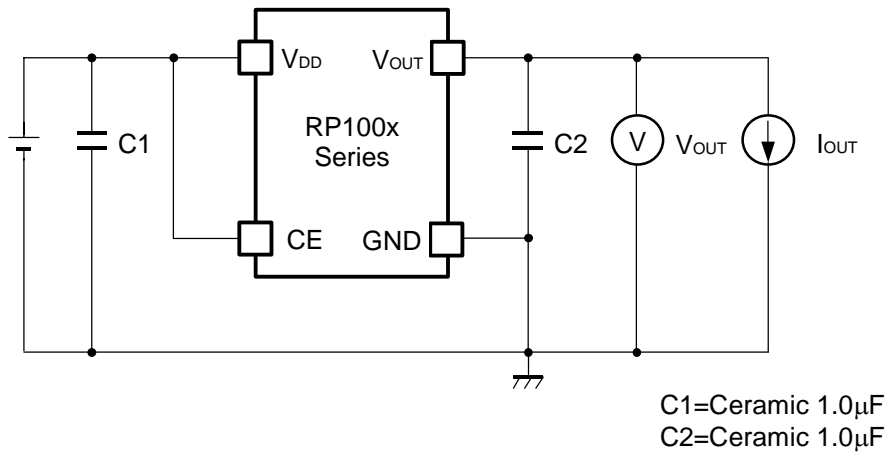

Basic Test Circuit

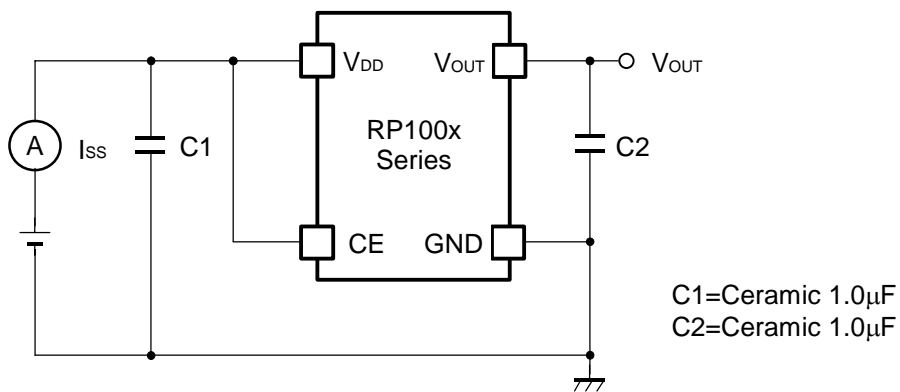

Test Circuit for Supply Current

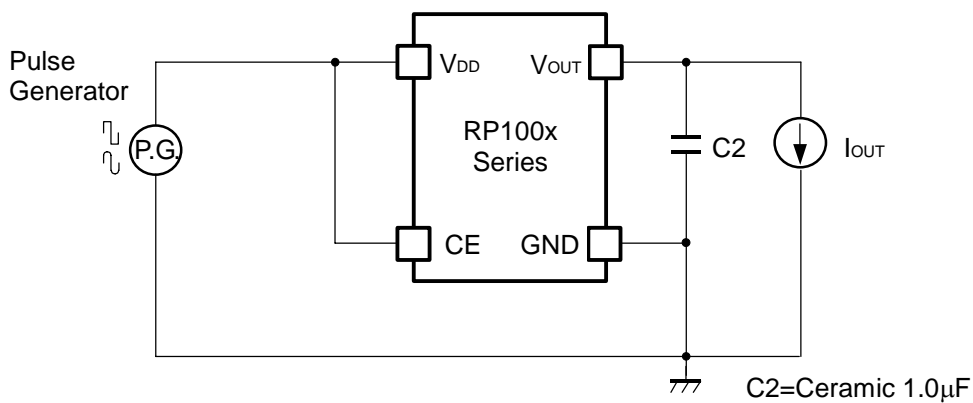

Test Circuit for Ripple Rejection

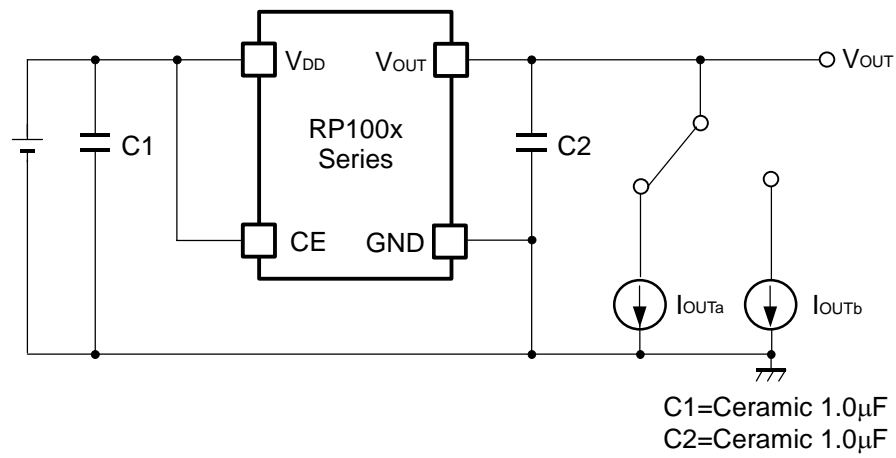

Test Circuit for Load Transient Response

RP100x

TYPICAL CHARACTERISTICS

1) Output Voltage vs. Output Current ($C_1=1.0\mu\text{F}$, $C_2=1.0\mu\text{F}$, $T_{\text{opt}}=25^\circ\text{C}$)

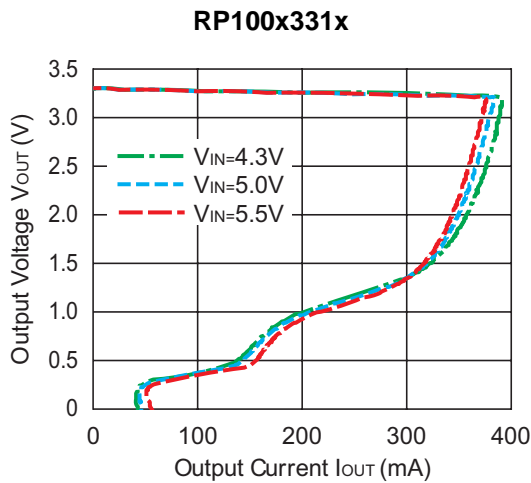
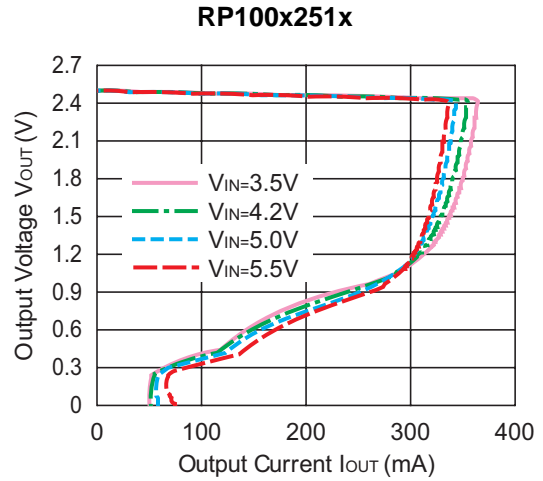
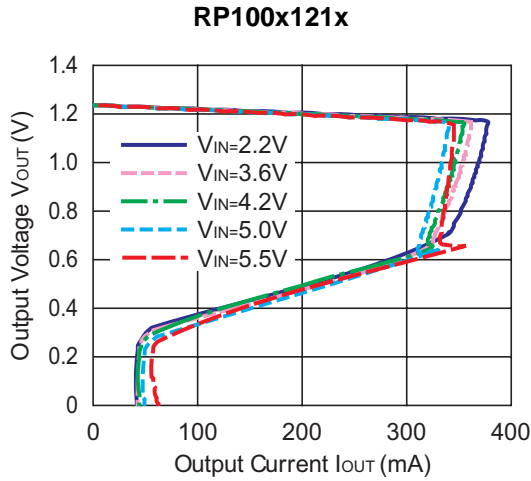

2) Output Voltage vs. Input Voltage ($C_1=1.0\mu\text{F}$, $C_2=1.0\mu\text{F}$, $T_{\text{opt}}=25^\circ\text{C}$)

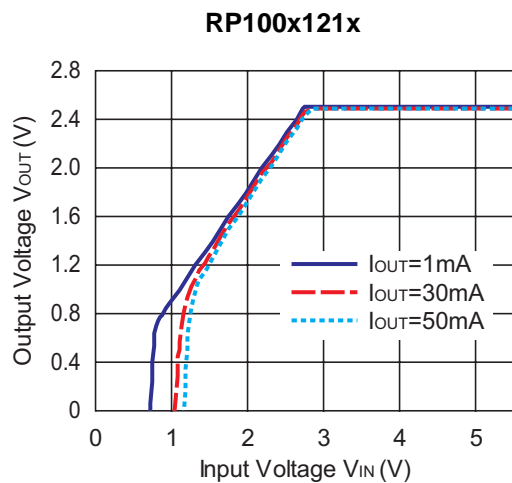
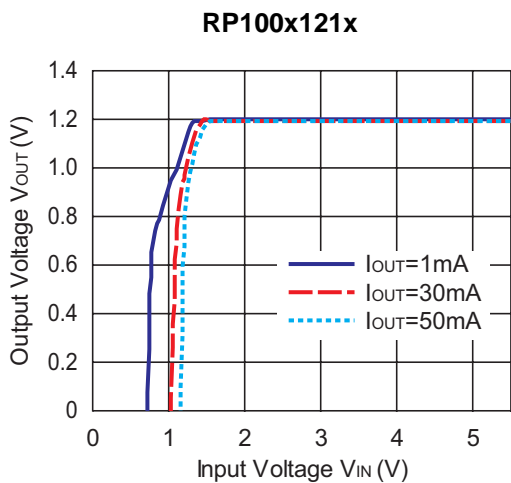

RP100x121x

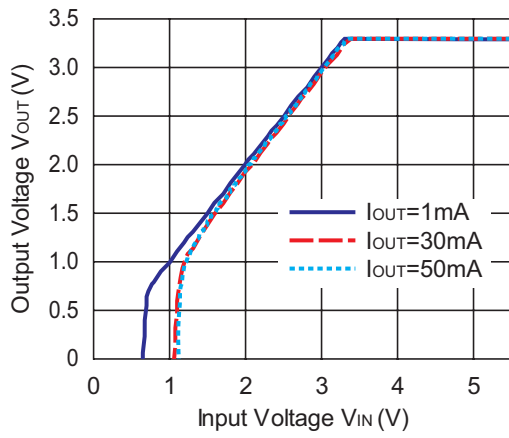

3) Supply Current vs. Input Voltage ($C1=1.0\mu F$, $C2=1.0\mu F$, $T_{opt}=25^{\circ}C$)

RP100x121x

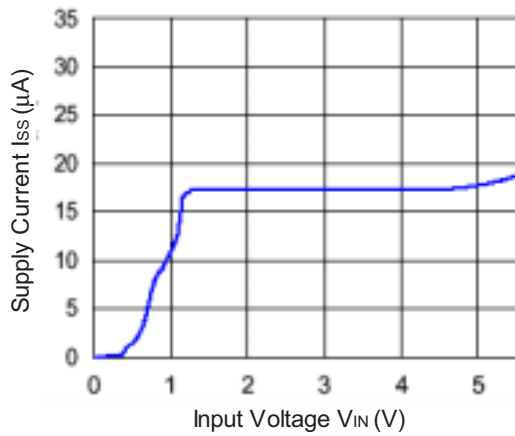

RP100x251x

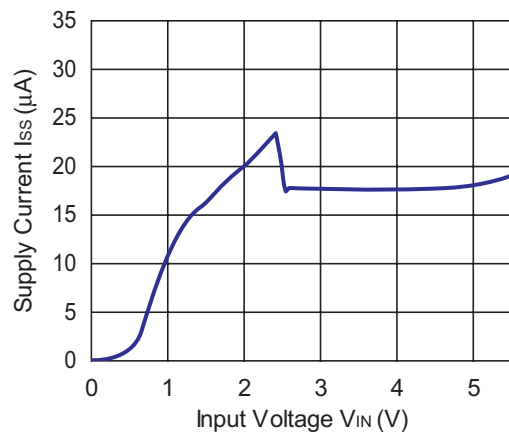

RP100x331x

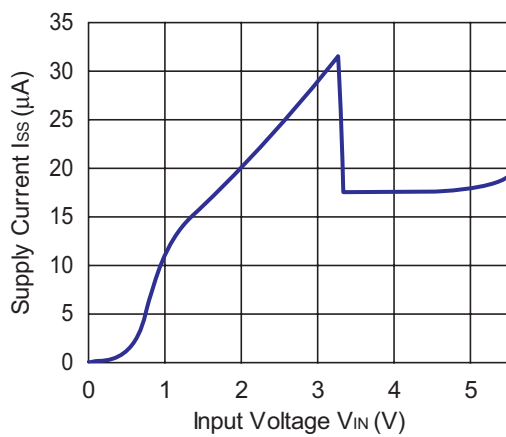

RP100x

4) Output Voltage vs. Temperature (C1=1.0μF, C2=1.0μF, I_{OUT}=1mA)

RP100x121x

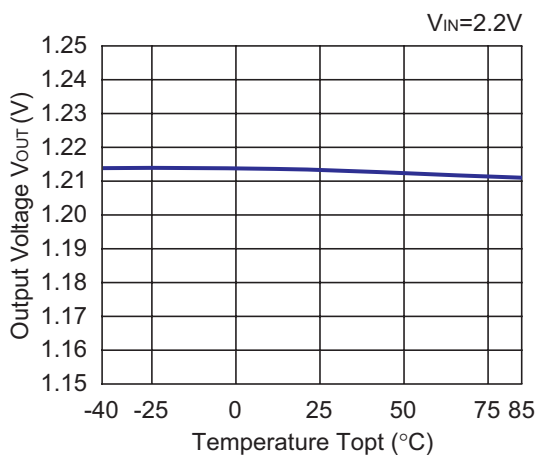

RP100x251x

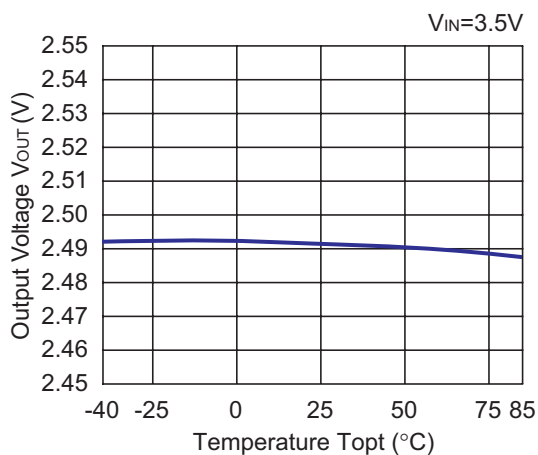

RP100x331x

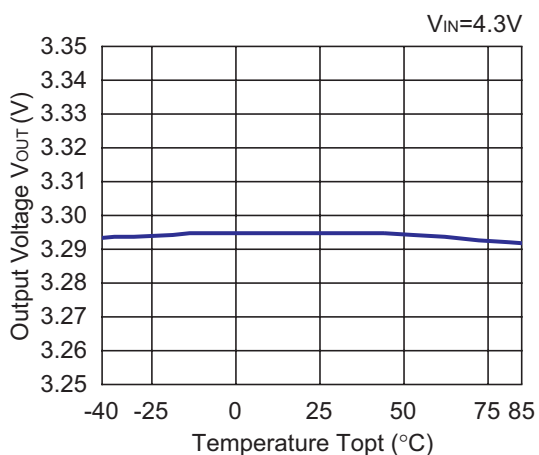

5) Supply Current vs. Temperature (C1=1.0μF, C2=1.0μF, I_{OUT}=0mA)

RP100x121x

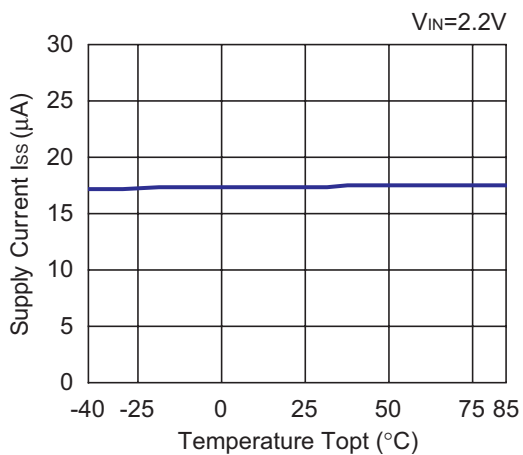

RP100x251x

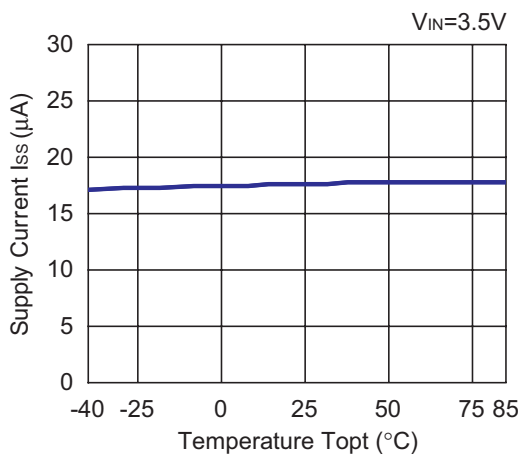

RP100x331x

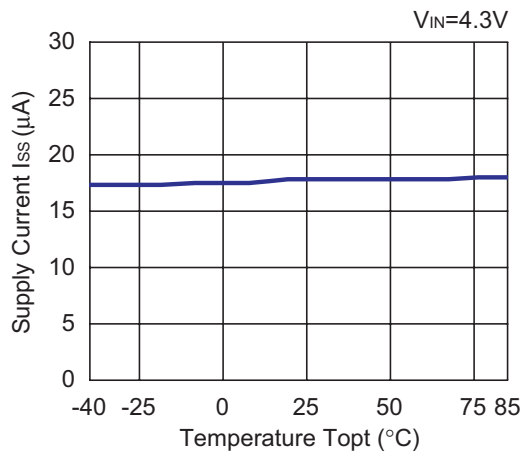

6) Dropout Voltage vs. Output Current (C1=1.0µF,C2=1.0µF)

RP100x121x

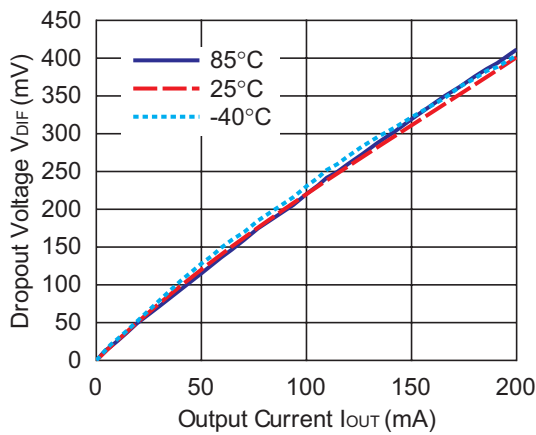

RP100x151x

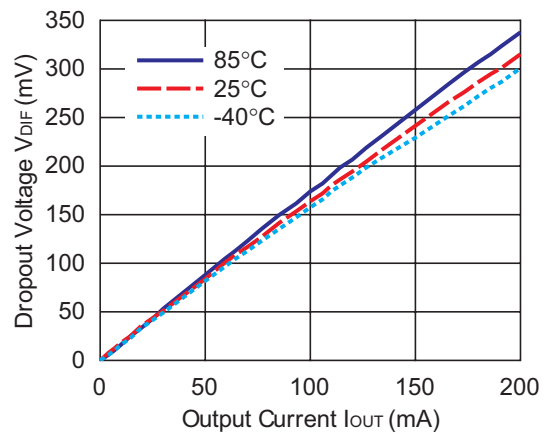

RP100x171x

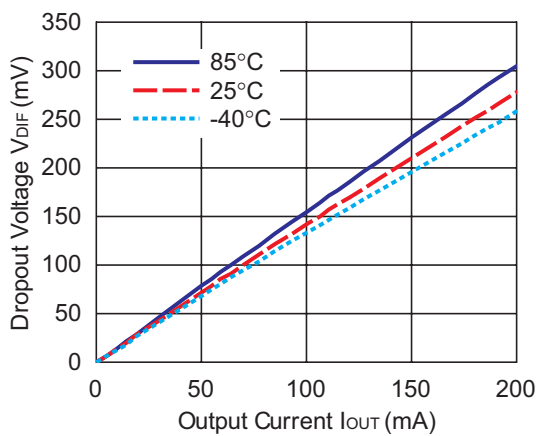

RP100x201x

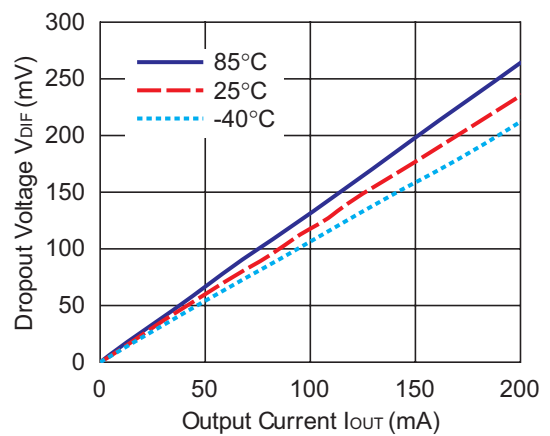

RP100x

RP100x251x

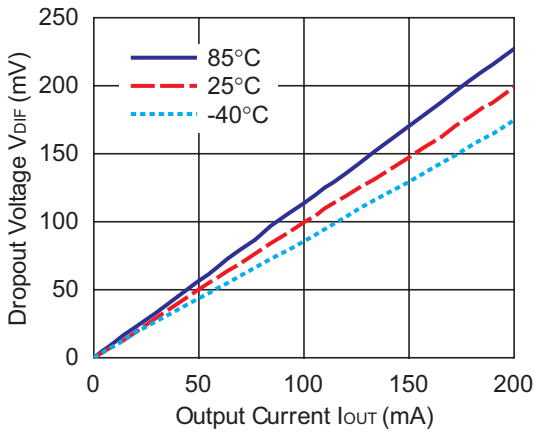

RP100x281x

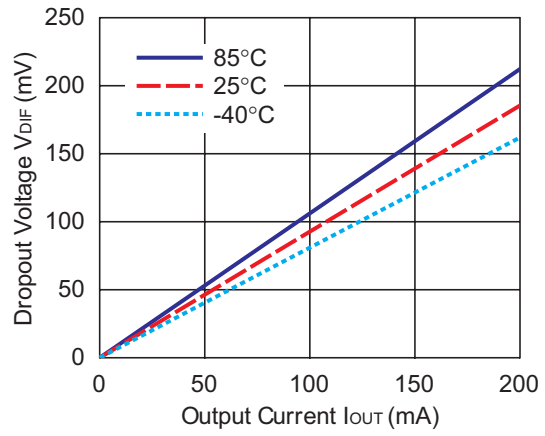

RP100x331x

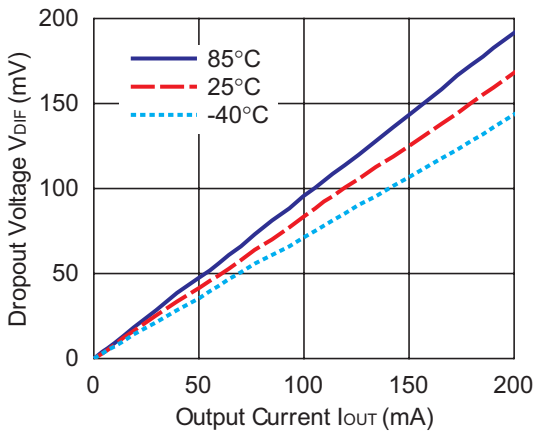

7) Dropout Voltage vs Set Output Voltage ($C1=1.0\mu F$, $C2=1.0\mu F$, $T_{opt}=25^\circ C$)

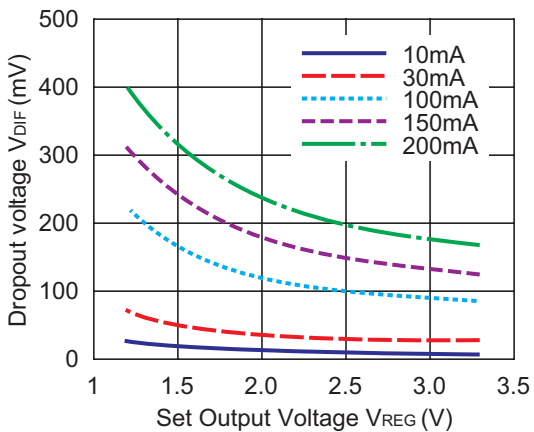

8) Ripple Rejection vs. Input Bias Voltage (C1=none, C2=1.0μF, Ripple=0.2V_{P-P}, T_{opt}=25°C)

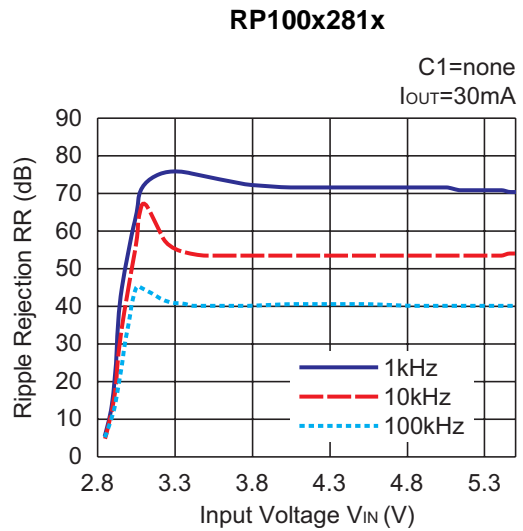
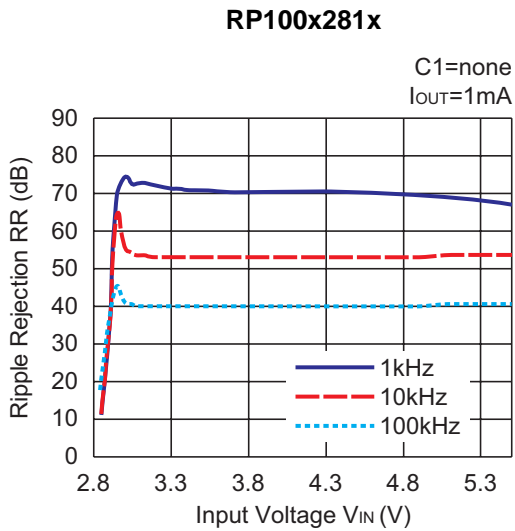
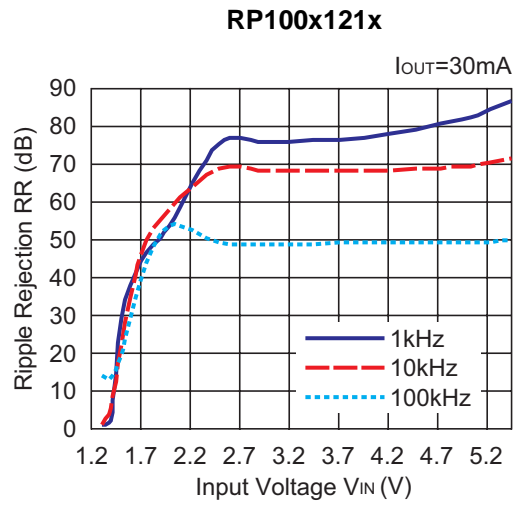
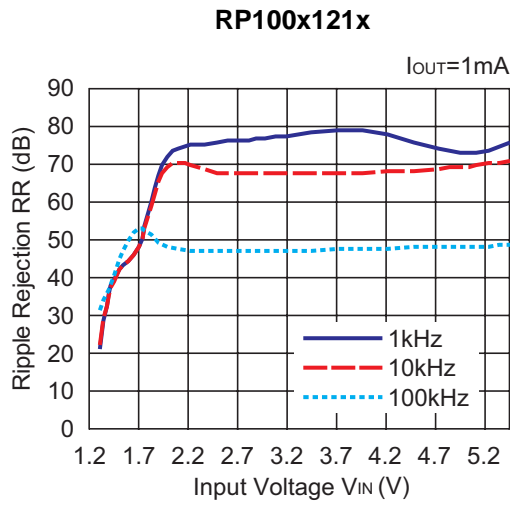

9) Ripple Rejection vs. Frequency (C1=none, C2=1.0μF, Ripple=0.2V_{P-P})

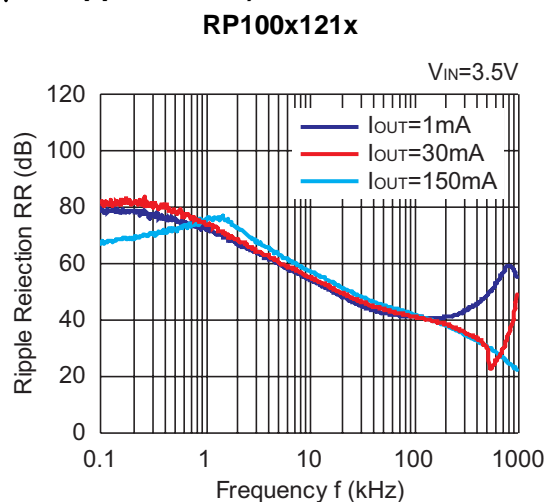
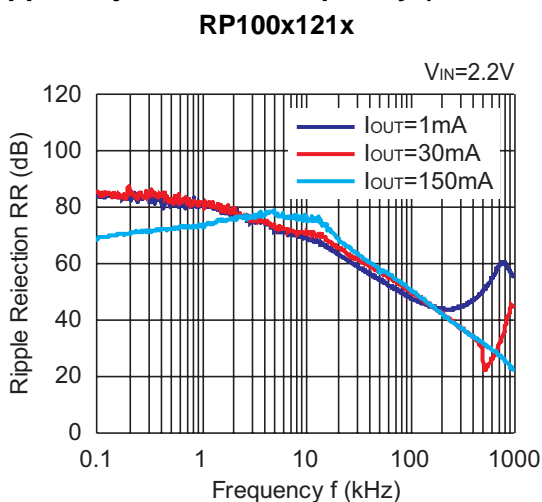

RP100x

RP100x331x

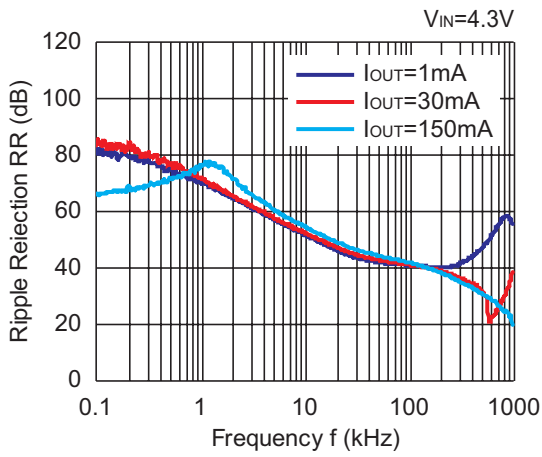

RP100x121x

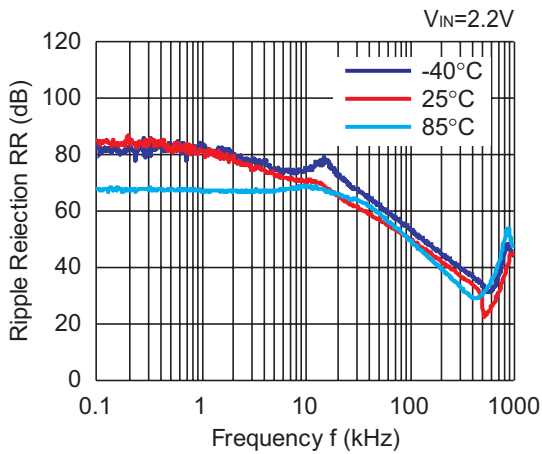

RP100x251x

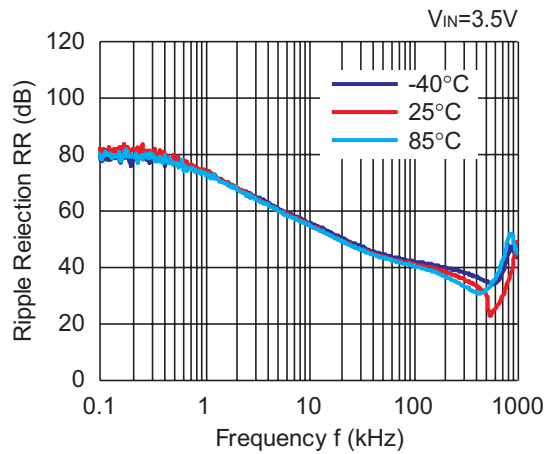

RP100x331x

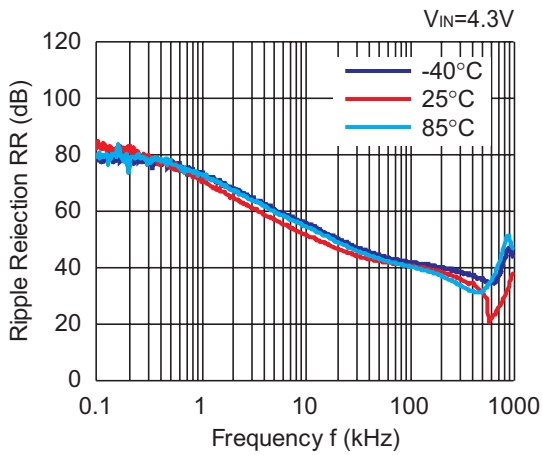

10) Input Transient Response ($I_{OUT}=30mA$, $t_r=t_f=5\mu s$, $T_{opt}=25^\circ C$)

RP100x121x

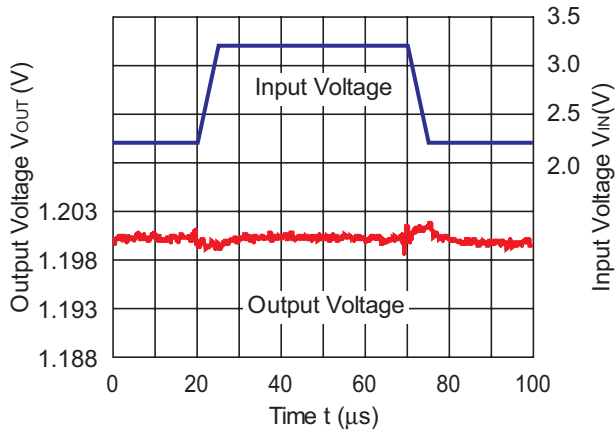

RP100x251x

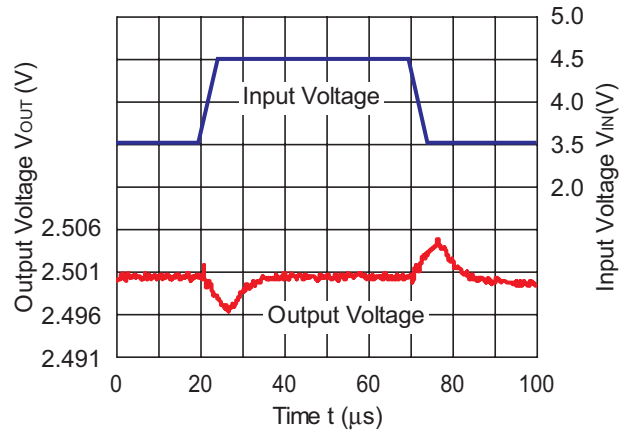

RP100x331x

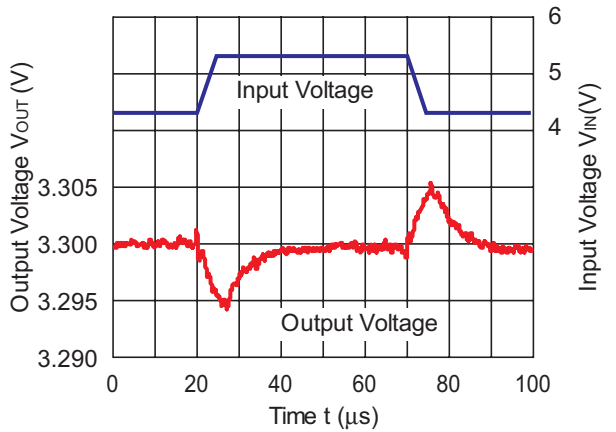

11) Load Transient Response ($C_2=1.0\mu F$, $T_{opt}=25^\circ C$)

RP100x121x

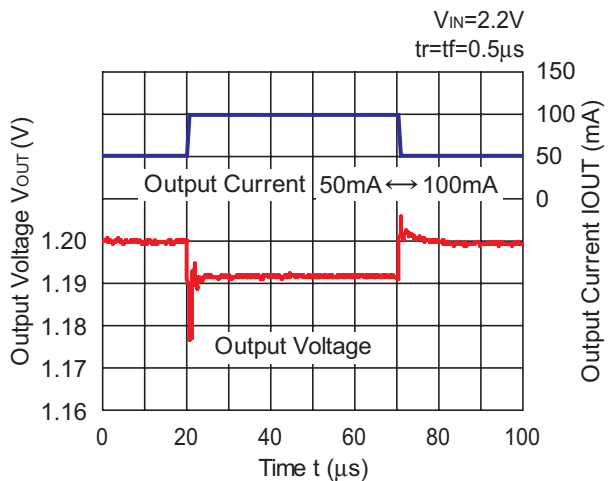

RP100x251x

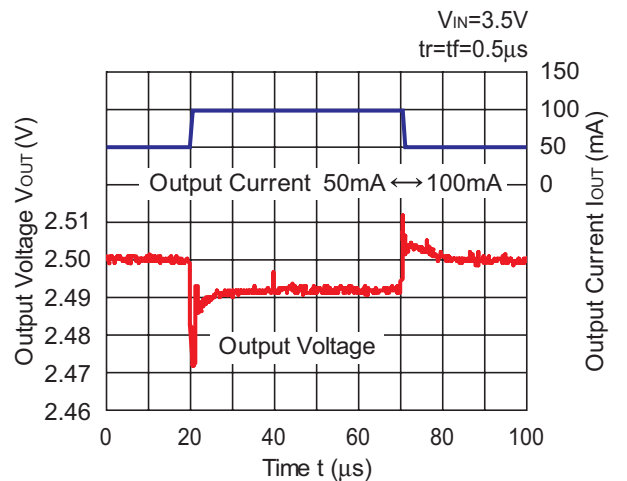

RP100x

RP100x331x

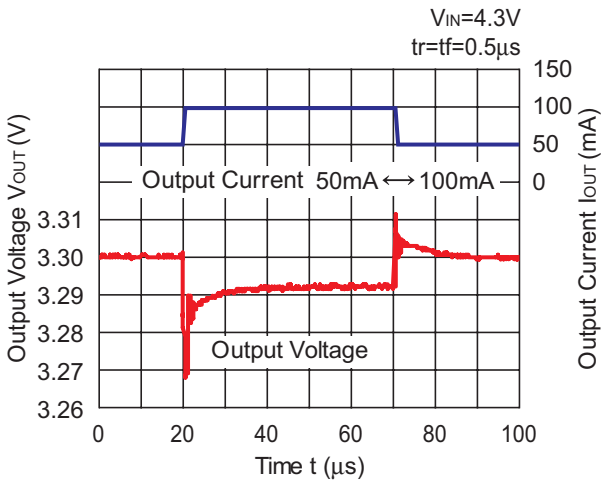

RP100x121x

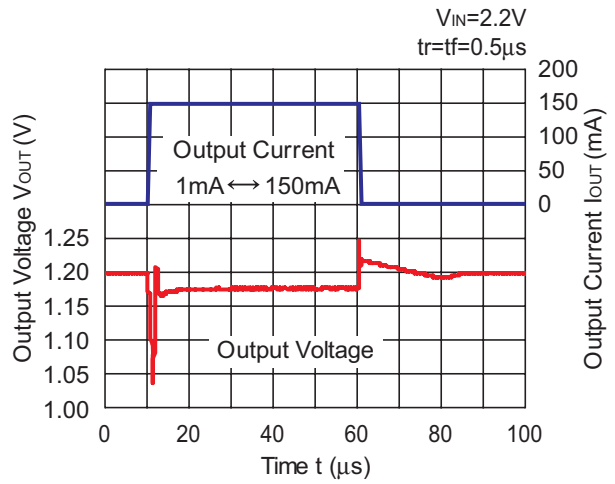

RP100x251x

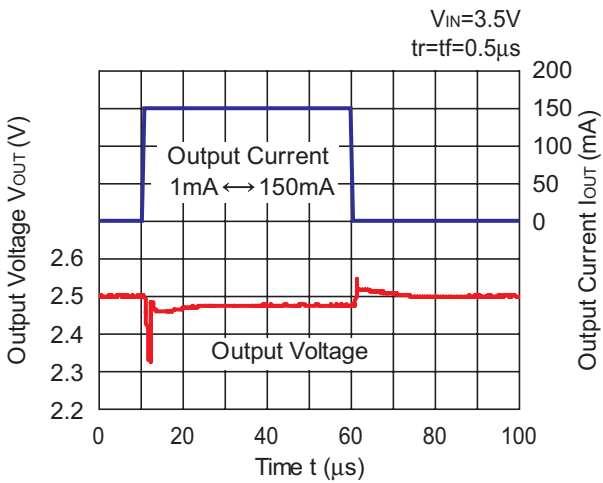

RP100x331x

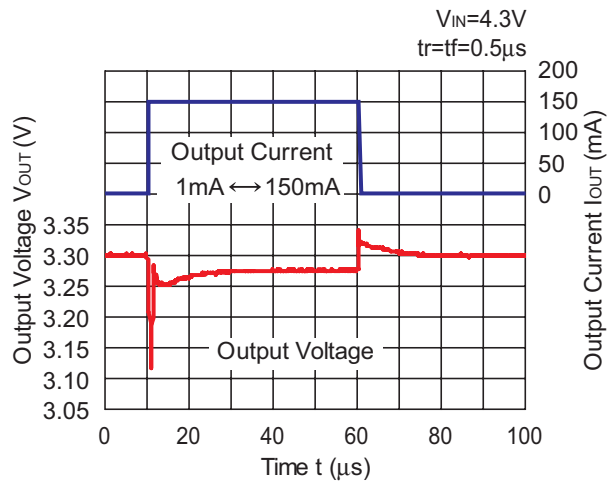

RP100x121x

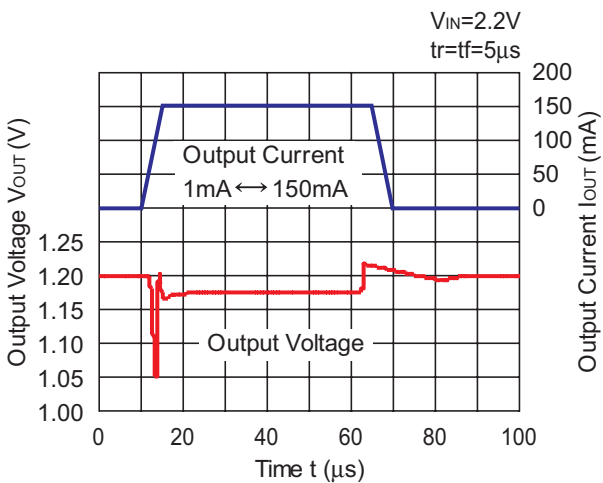

RP100x251x

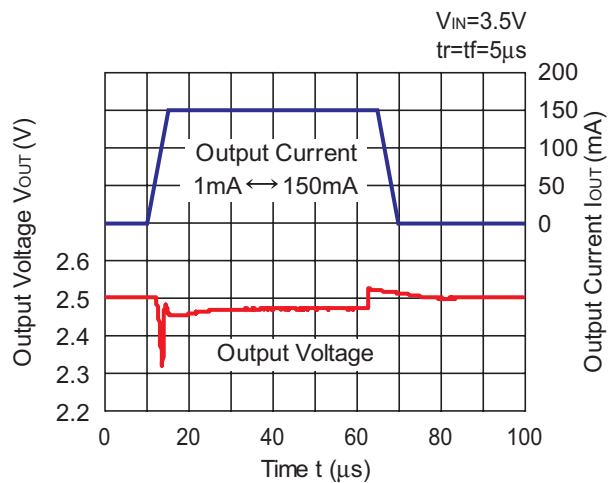

RP100x331x

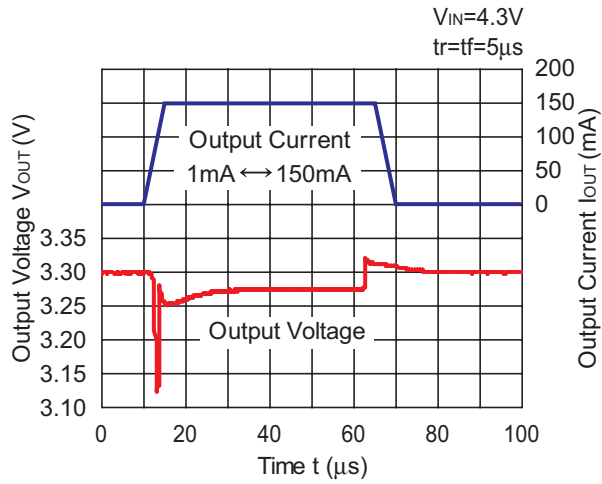

12) Turn On Speed with CE pin ($C1=1.0\mu F$, $C2=1.0\mu F$, $T_{opt}=25^{\circ}C$)

RP100x121x

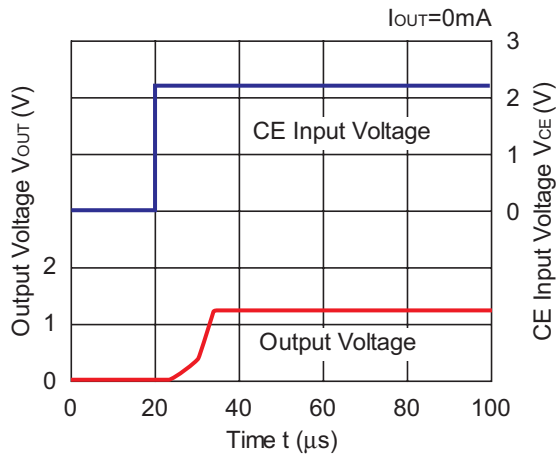

RP100x121x

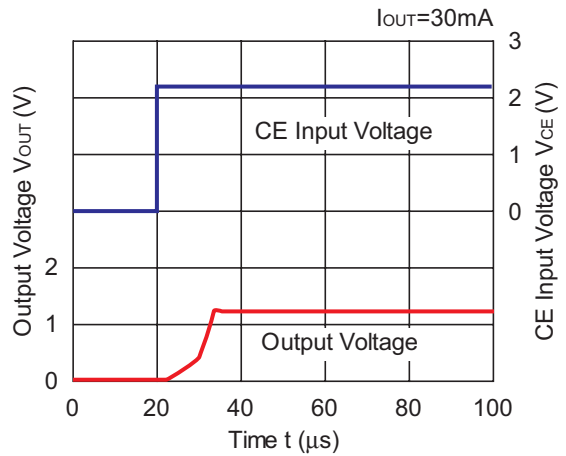

RP100x121x

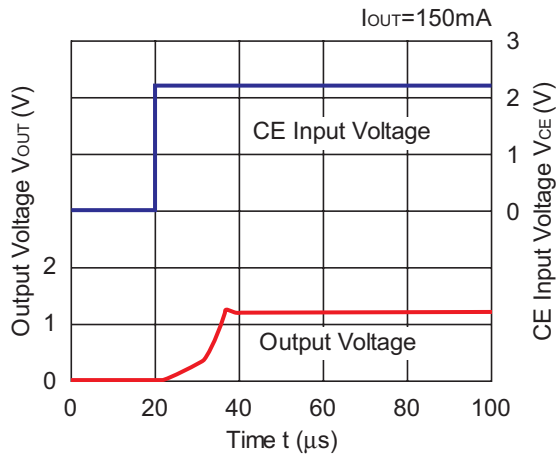

RP100x

RP100x251x

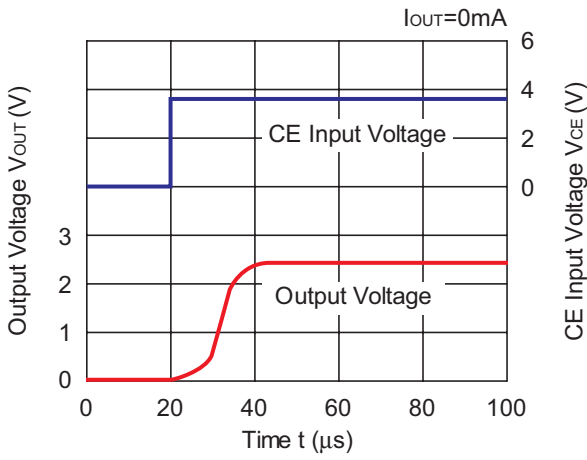

RP100x251x

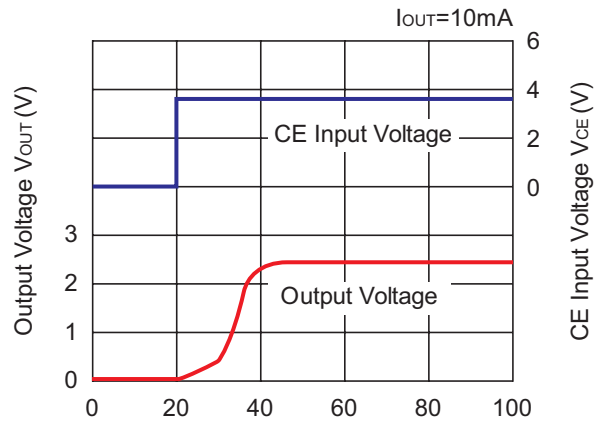

RP100x251x

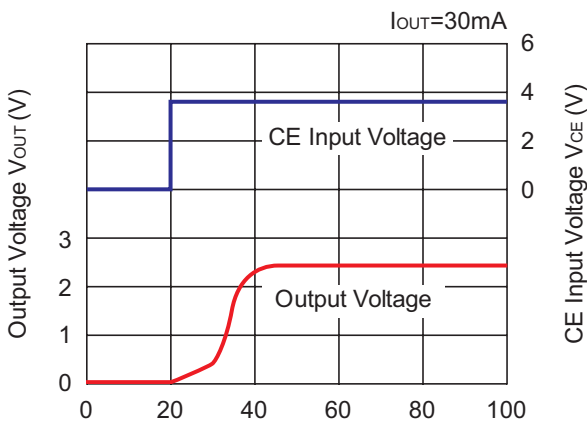

RP100x251x

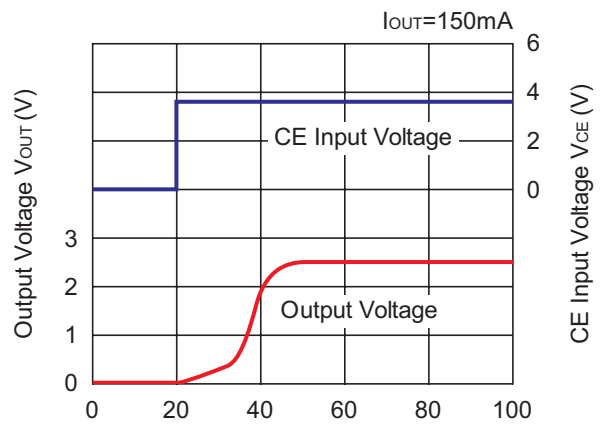

RP100x331x

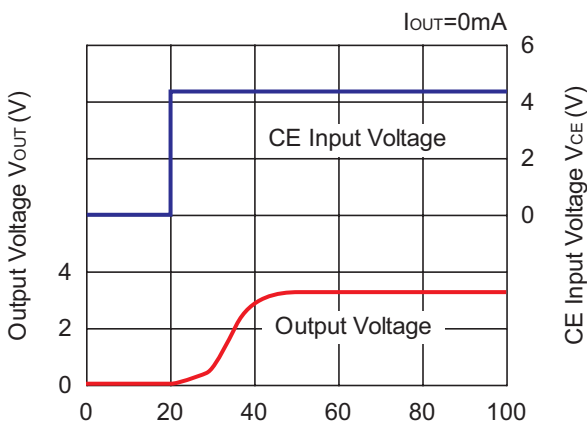

RP100x331x

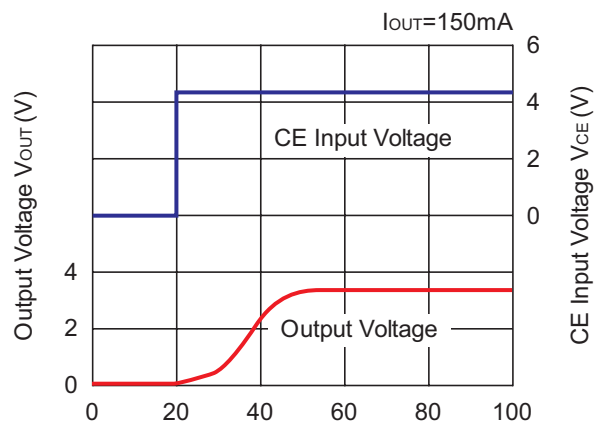

13) Turn Off Speed with CE pin (D Version) (C1=1.0μF, C2=1.0μF, T_{opt}=25°C)

RP100x121D

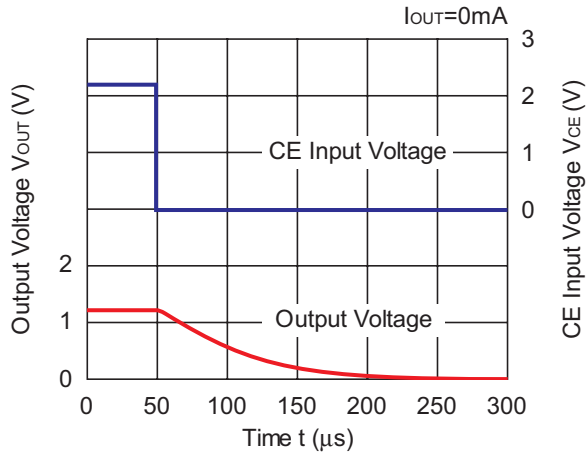

RP100x121D

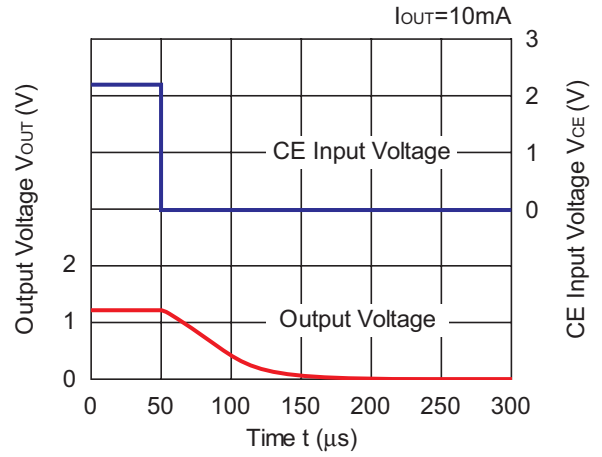

RP100x121D

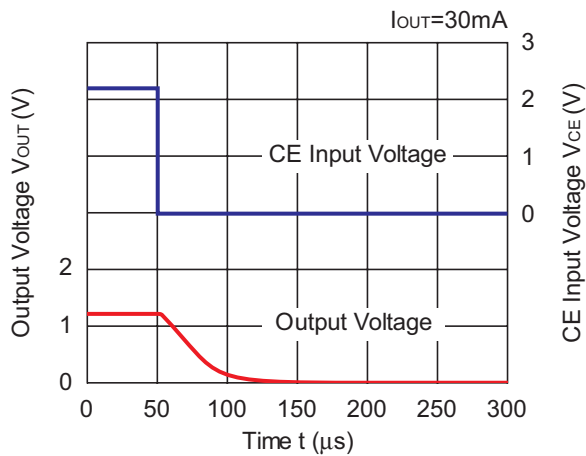

RP100x121D

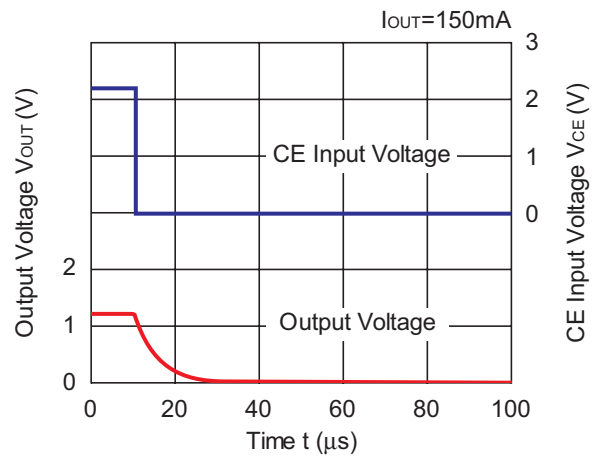

RP100x251D

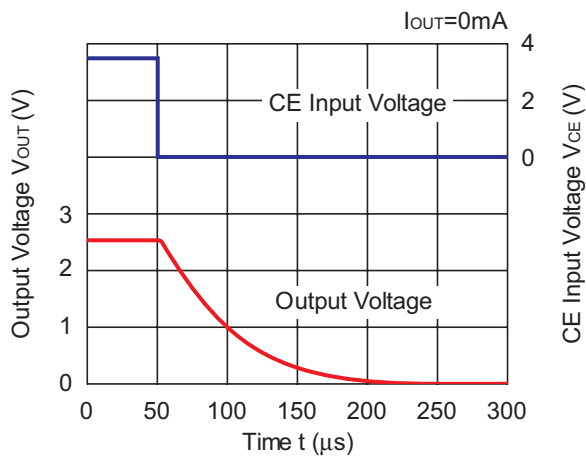

RP100x251D

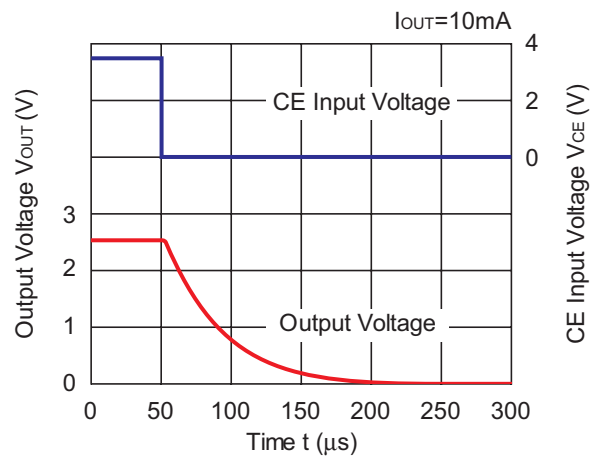

RP100x

RP100x251D

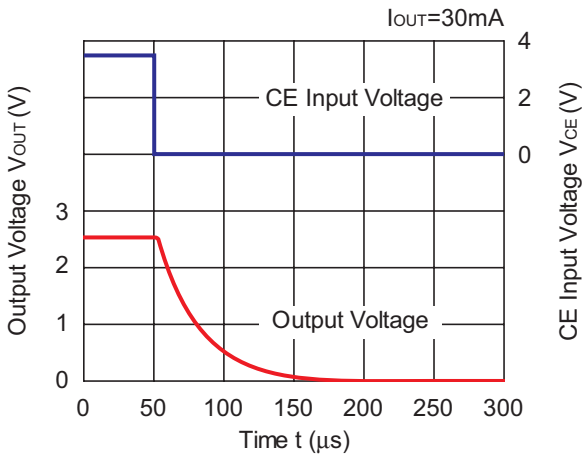

RP100x251D

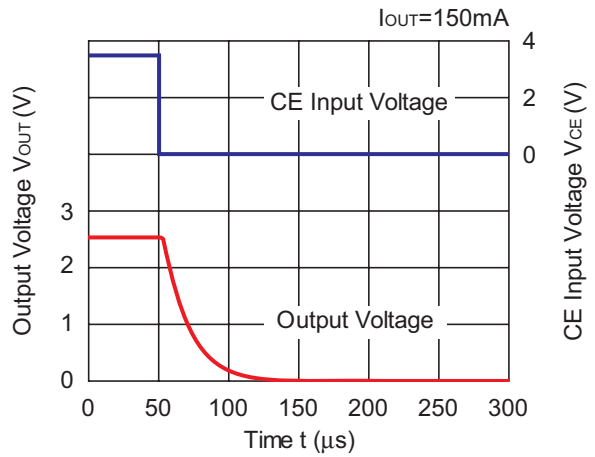

RP100x331D

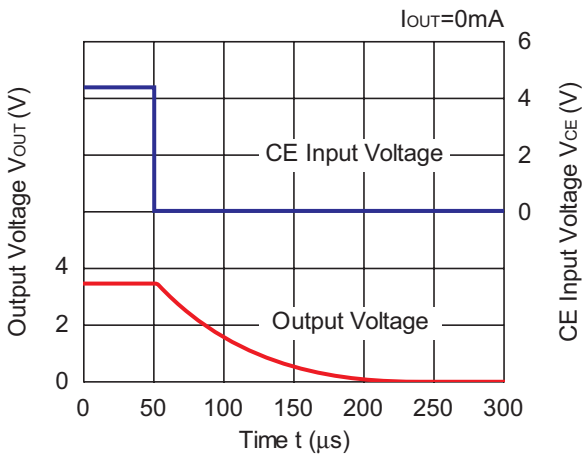

RP100x331D

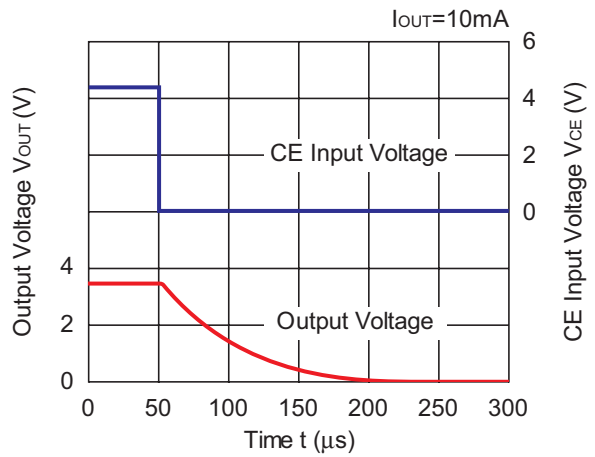

RP100x331D

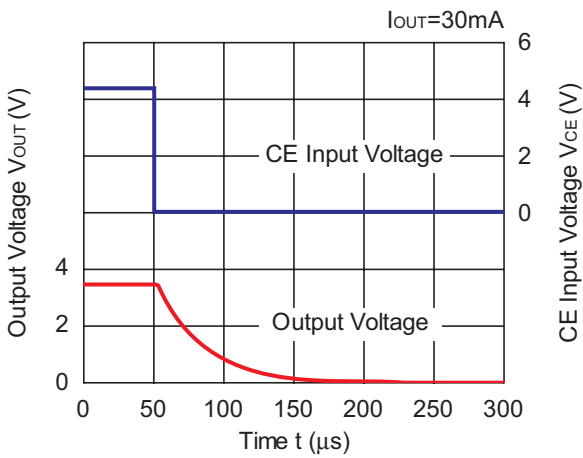

RP100x331Dx

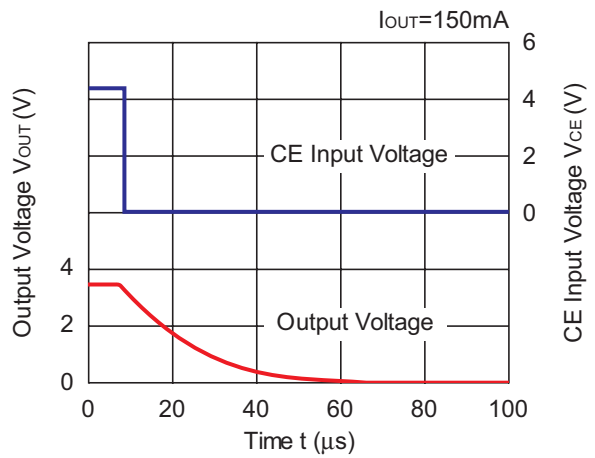

14) Dropout Voltage vs Temperature (C1=1.0μF, C2=1.0μF)

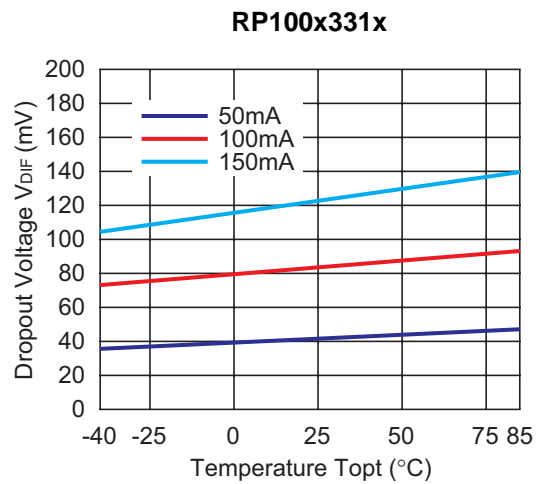
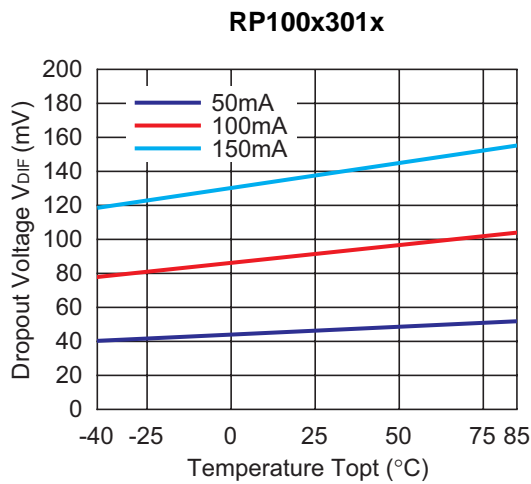
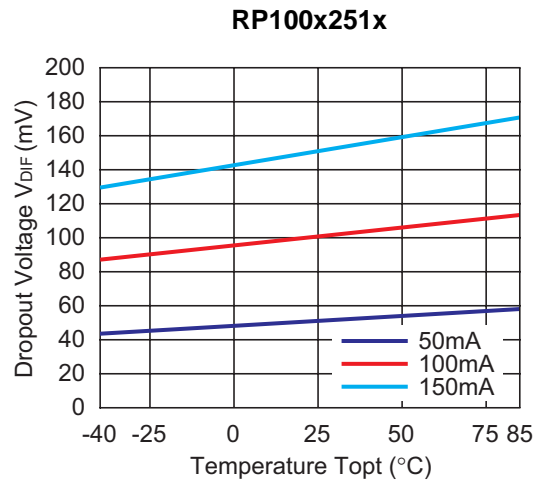
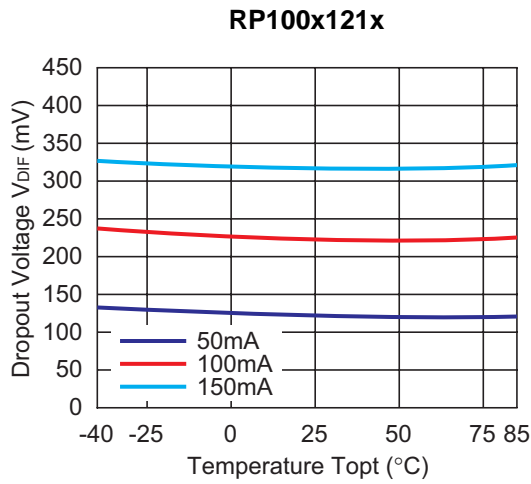

15) Output Voltage vs. Input Voltage (C1=1.0μF, C2=1.0μF)

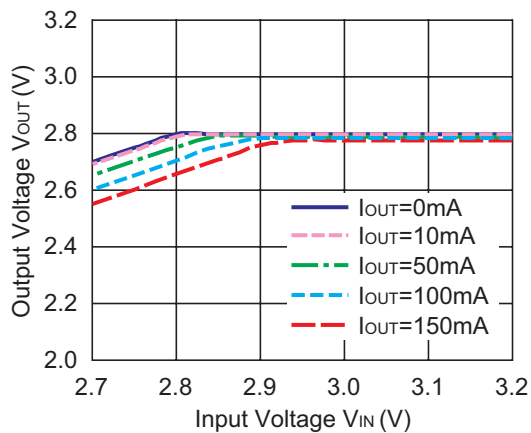

RP100x

ESR vs. Output Current

When using these ICs, consider the following points:

The relations between I_{OUT} (Output Current) and ESR of an output capacitor are shown below.

The conditions when the white noise level is under $40\mu\text{V}$ (Avg.) are marked as the hatched area in the graph.

Measurement conditions

Frequency Band: 10Hz to 2MHz

Temperature: -40°C to 85°C

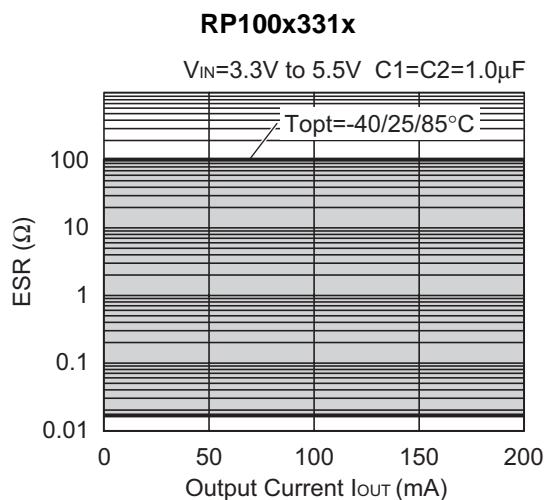
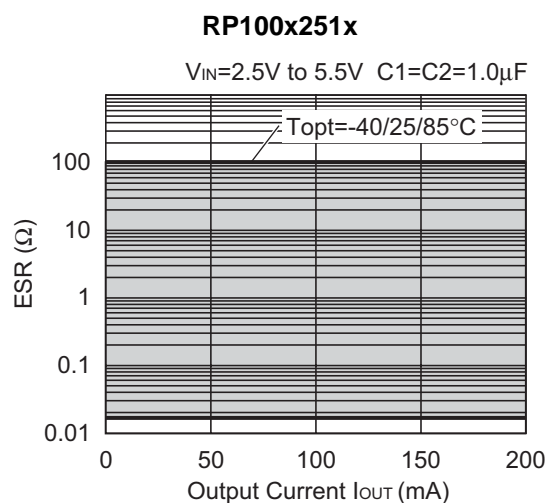
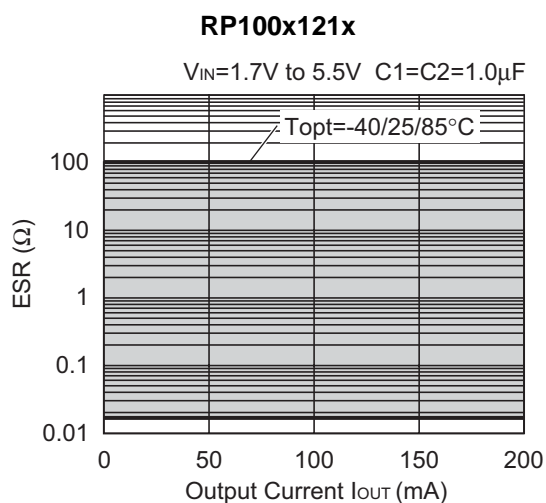

• PLP1612-4

Unit: mm

PACKAGE DIMENSIONS

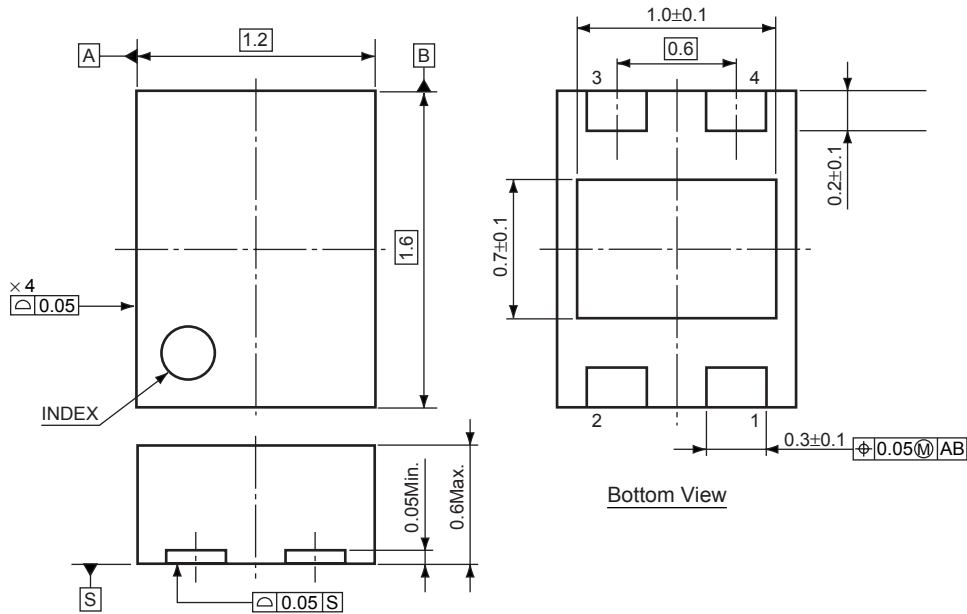

TAPING SPECIFICATION

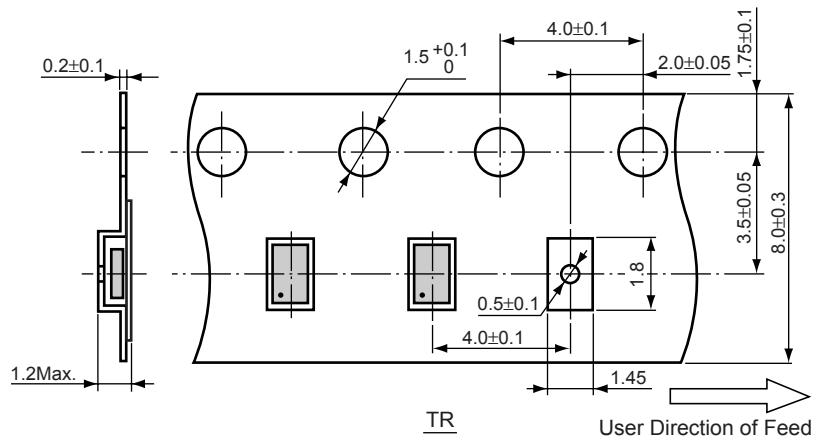

TAPING REEL DIMENSIONS REUSE REEL (EIAJ-RRM-08Bc)

(1reel=5000pcs)

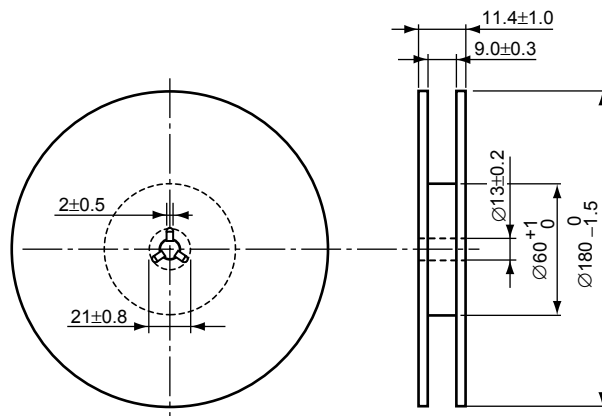

POWER DISSIPATION (PLP1612-4)

This specification is at mounted on board. Power Dissipation (P_D) depends on conditions of mounting on board. This specification is based on the measurement at the condition below:

Measurement Conditions

	Standard Land Pattern
Environment	Mounting on Board (Wind velocity=0m/s)
Board Material	Glass cloth epoxy plastic (Double sided)
Board Dimensions	40mm × 40mm × 1.6mm
Copper Ratio	Top side : Approx. 50% , Back side : Approx. 50%
Through-hole	φ0.54mm × 24pcs

Measurement Result ($T_{opt}=25^{\circ}\text{C}$, $T_{jmax}=125^{\circ}\text{C}$)

	Standard Land Pattern
Power Dissipation	610mW
Thermal Resistance	$\theta_{ja}=(125-25^{\circ}\text{C})/0.61\text{W}=164^{\circ}\text{C/W}$

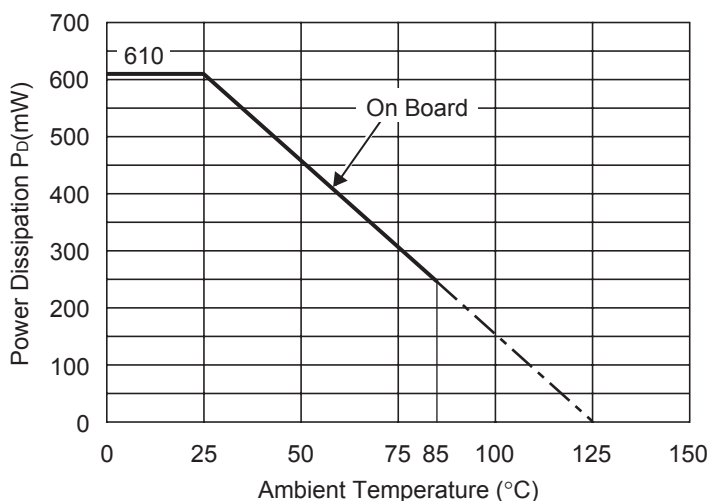

Power Dissipation

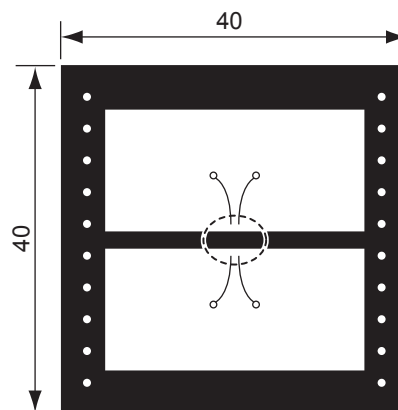

Measurement Board Pattern

○ IC Mount Area Unit : mm

RECOMMENDED LAND PATTERN

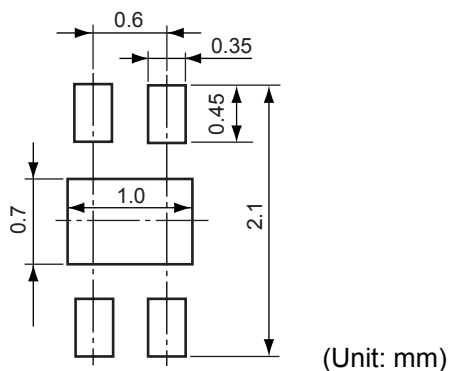

- SOT-23-5 (SC-74A)

Unit: mm

PACKAGE DIMENSIONS

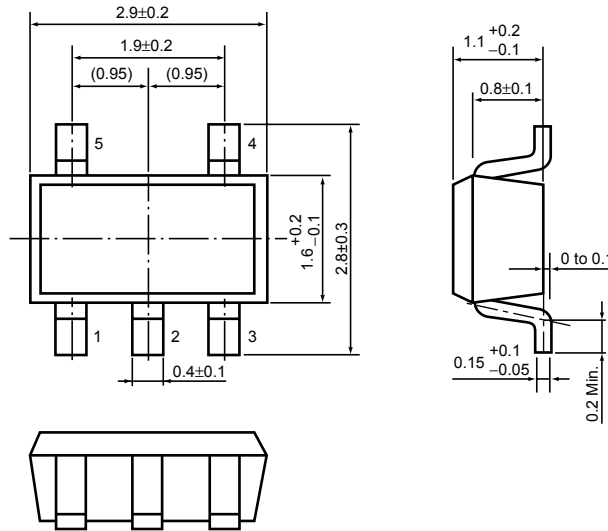

TAPING SPECIFICATION

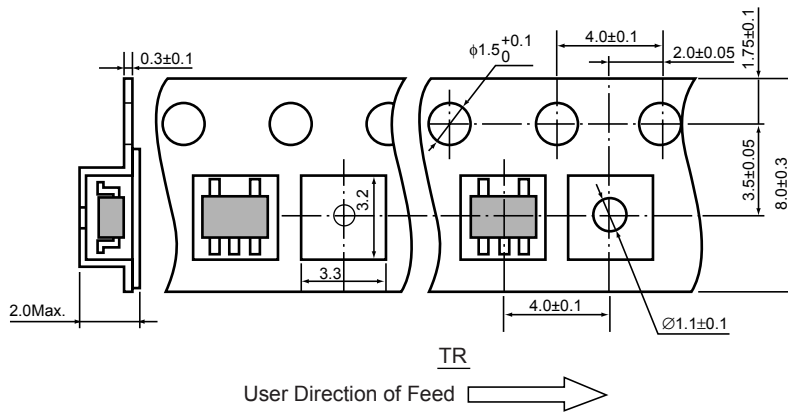

TAPING REEL DIMENSIONS REUSE REEL (EIAJ-RRM-08Bc)

(1reel=3000pcs)

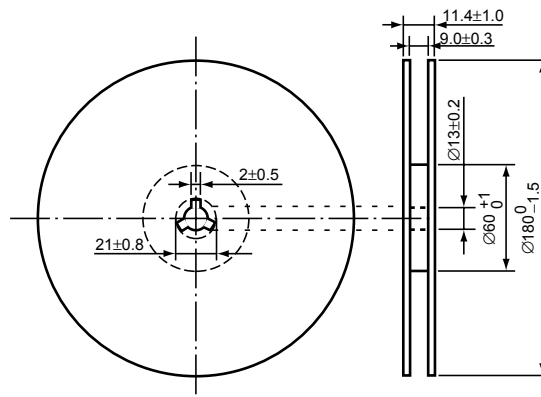

POWER DISSIPATION (SOT-23-5)

This specification is at mounted on board. Power Dissipation (P_D) depends on conditions of mounting on board. This specification is based on the measurement at the condition below:

(Power Dissipation (SOT-23-5) is substitution of SOT-23-6.)

Measurement Conditions

	Standard Land Pattern
Environment	Mounting on Board (Wind velocity=0m/s)
Board Material	Glass cloth epoxy plactic (Double sided)
Board Dimensions	40mm × 40mm × 1.6mm
Copper Ratio	Top side : Approx. 50% , Back side : Approx. 50%
Through-hole	φ0.5mm × 44pcs

Measurement Result

($T_{opt}=25^{\circ}\text{C}$, $T_{jmax}=125^{\circ}\text{C}$)

	Standard Land Pattern	Free Air
Power Dissipation	420mW	250mW
Thermal Resistance	$\theta_{ja}=(125-25^{\circ}\text{C})/0.42\text{W}=263^{\circ}\text{C/W}$	400 $^{\circ}\text{C/W}$

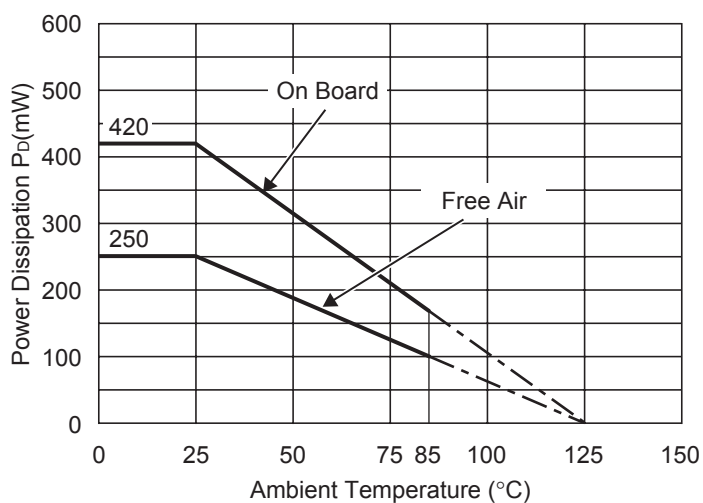

Power Dissipation

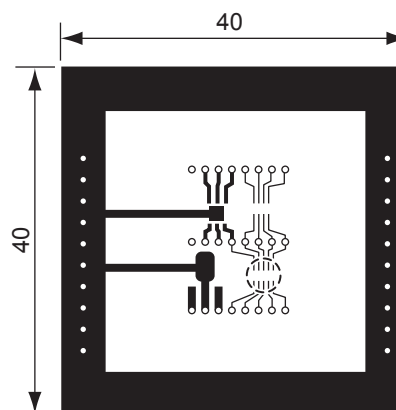

Measurement Board Pattern

○ IC Mount Area Unit : mm

RECOMMENDED LAND PATTERN

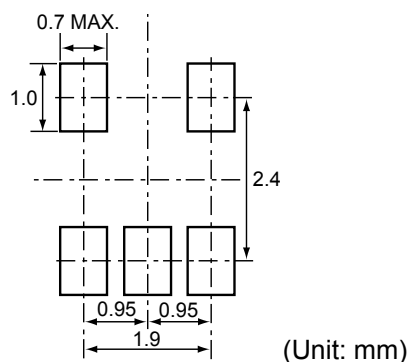

RP100K SERIES MARK SPECIFICATION

● PLP1612-4

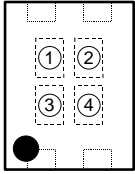

①, ② : Product Code (refer to Part Number vs. Product Code)

③, ④ : Lot Number

● Part Number vs. Product Code

Part Number	Product Code	
	①	②
RP100K121B	1	A
RP100K131B	1	B
RP100K151B	1	C
RP100K181B	1	D
RP100K181B5	1	E
RP100K191B	1	F
RP100K201B	1	G
RP100K251B	1	H
RP100K261B	1	J
RP100K271B	1	K
RP100K281B	1	L
RP100K281B5	1	M
RP100K291B	1	N
RP100K301B	1	P
RP100K311B	1	Q
RP100K331B	1	R
RP100K211B	1	S

Part Number	Product Code	
	①	②
RP100K121D	2	A
RP100K131D	2	B
RP100K151D	2	C
RP100K181D	2	D
RP100K181D5	2	E
RP100K191D	2	F
RP100K201D	2	G
RP100K251D	2	H
RP100K261D	2	J
RP100K271D	2	K
RP100K281D	2	L
RP100K281D5	2	M
RP100K291D	2	N
RP100K301D	2	P
RP100K311D	2	Q
RP100K331D	2	R
RP100K211D	2	S

RP100N SERIES MARK SPECIFICATION

• SOT-23-5 (SC-74A)

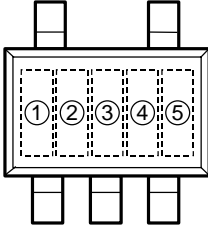

①, ②, ③ : Product Code (refer to Part Number vs. Product Code)

④, ⑤ : Lot Number

• Part Number vs. Product Code

Part Number	Product Code		
	①	②	③
RP100N121B	5	0	A
RP100N131B	5	0	B
RP100N151B	5	0	C
RP100N181B	5	0	D
RP100N181B5	5	0	E
RP100N191B	5	0	F
RP100N201B	5	0	G
RP100N251B	5	0	H
RP100N261B	5	0	J
RP100N271B	5	0	K
RP100N281B	5	0	L
RP100N281B5	5	0	M
RP100N291B	5	0	N
RP100N301B	5	0	P
RP100N311B	5	0	Q
RP100N331B	5	0	R
RP100N211B	5	0	S

Part Number	Product Code		
	①	②	③
RP100N121D	5	1	A
RP100N131D	5	1	B
RP100N151D	5	1	C
RP100N181D	5	1	D
RP100N181D5	5	1	E
RP100N191D	5	1	F
RP100N201D	5	1	G
RP100N251D	5	1	H
RP100N261D	5	1	J
RP100N271D	5	1	K
RP100N281D	5	1	L
RP100N281D5	5	1	M
RP100N291D	5	1	N
RP100N301D	5	1	P
RP100N311D	5	1	Q
RP100N331D	5	1	R
RP100N211D	5	1	S