

Operational Amplifiers / Comparators

High Speed with High Voltage Operational Amplifiers



BA3472F,BA3472FV,BA3472FVM,BA3472RFVM
BA3474F,BA3474FV,BA3474RFV

No.11049EBT17

●Description

General-purpose BA3472 / BA3474 family integrate two/four Independent Op-amps and phase compensation capacitors on a single chip and have some features of high-gain, low power consumption, and wide operating voltage range of +3[V] ~ +36[V](single power supply). Especially, characteristics are high slew rate (10V/μs) and high Maximum frequency (4MHz).

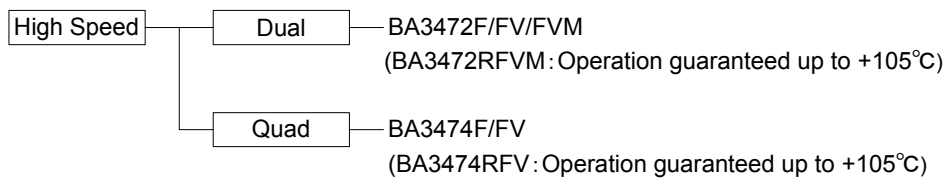

●Features

- 1) Operable with a single power supply
- 2) Wide operating supply voltage
+3.0 [V] ~ +36.0 [V] (single supply)
±1.5 [V] ~ ±18.0 [V] (split supply)
- 3) Standard Op-Amp. Pin-assignments
- 4) Internal phase compensation
- 5) High slew rate: 10[V/μs]
- 6) Maximum frequency: 4[MHz]
- 7) High open loop voltage gain
- 8) Internal ESD protection
Human body model (HBM) ±5000 [V] (Typ.)
- 9) Operable low input voltage around GND level
- 10) Wide output voltage range
VEE+0.3[V] ~ VCC-1.0[V](Typ.)
with VCC-VEE=30[V]

●Pin Assignment

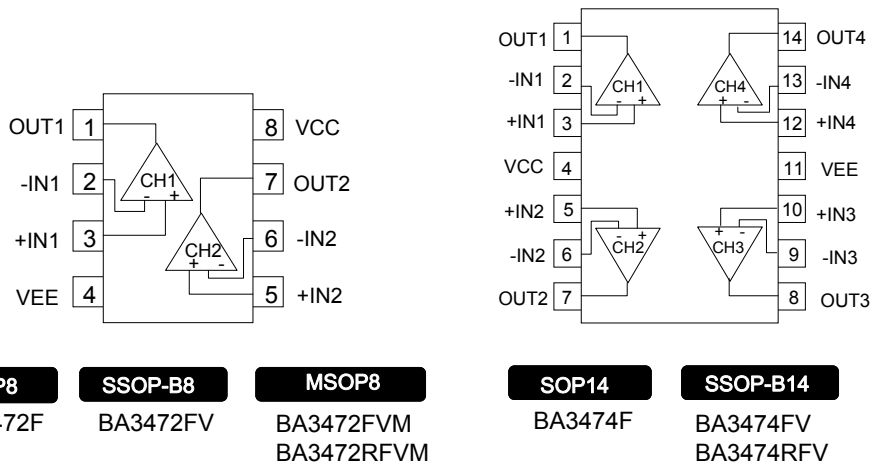

●Absolute Maximum Ratings (Ta=25°C)

Parameter	Symbol	Ratings		Unit
		BA3472 family BA3474 family	BA3472R family BA3474R family	
Supply Voltage	VCC-VEE	+36		V
Differential Input Voltage (*1)	Vid	36		V
Input Common-mode Voltage Range	Vicm	(VEE - 0.3) ~ VEE + 36		V
Operating Temperature Range	Topr	-40 ~ +85(SOP14:+75)	-40 ~ +105	°C
Storage Temperature Range	Tstg	-55 ~ +150		°C
Maximum Junction Temperature	Tjmax	+150		°C

Note: Absolute maximum rating item indicates the condition which must not be exceeded.

Application if voltage in excess of absolute maximum rating or use out of absolute maximum rated temperature environment may cause deterioration of characteristics.

(*1) The voltage difference between inverting input and non-inverting input is the differential input voltage. Then input terminal voltage is set to more than VEE.

●Electric Characteristics

OBA3472 family (Unless otherwise specified VCC=+15[V], VEE=-15[V], Ta=25°C)

Parameter	Symbol	Temperature range	Limits			Unit	Condition
			BA3472F/FV/FVM				
			Min.	Typ.	Max.		
Input Offset Voltage (*2)	Vio	25°C	-	1	10	mV	Vicm=0[V], VOUT=0[V]
			-	1.5	10		VCC=5[V], VEE=0[V], Vicm=0[V], VOUT=VCC/2
Input Offset Current (*2)	Iio	25°C	-	6	75	nA	Vicm=0[V], VOUT=0[V]
Input Bias Current (*2)	Ib	25°C	-	100	500	nA	Vicm=0[V], VOUT=0[V]
Supply Current	ICC	25°C	-	4	5.5	mA	RL=∞
High Level Output Voltage	VOH	25°C	3.7	4	-	V	VCC=5[V], RL=2[kΩ]
			13.7	14	-		RL=10[kΩ]
			13.5	-	-		RL=2[kΩ]
Low Level Output Voltage	VOL	25°C	-	0.1	0.3	V	VCC=5[V], RL=2[kΩ]
			-	-14.7	-14.3		RL=10[kΩ]
			-	-	-13.5		RL=2[kΩ]
Large Signal Voltage Gain	AV	25°C	80	100	-	dB	RL ≥ 2[kΩ], VOUT=±10 [V]
Input Common-mode Voltage Range	Vicm	25°C	0	-	VCC-2.0	V	VCC=5[V], VEE=0[V], VOUT=VCC/2
Common-mode Rejection Ratio	CMRR	25°C	60	97	-	dB	Vicm=0[V], VOUT=0[V]
Power Supply Rejection Ratio	PSRR	25°C	60	97	-	dB	Vicm=0[V], VOUT=0[V]
Output Source Current (*3)	IOH	25°C	10	30	-	mA	VIN+=1[V], VIN-=0[V], VOUT=0[V] Only 1ch is short circuit
Output Sink Current (*3)	IOL	25°C	20	30	-	mA	VIN+=0[V], VIN-=1[V], VOUT=5[V], Only 1ch is short circuit
Maximum Frequency	ft	25°C	-	4	-	MHz	-
Slew Rate	SR	25°C	-	10	-	V/μs	Av=1, Vin=-10 to +10[V], RL=2[kΩ]
Channel Separation	CS	25°C	-	120	-	dB	-

(*2) Absolute value

(*3) Under high temperatures, please consider the power dissipation when selecting the output current.

When the output terminal is continuously shorted the output current reduces the internal temperature by flushing.

OBA3472R family (Unless otherwise specified VCC=+15[V], VEE=-15[V], Ta=25[°C])

Parameter	Symbol	Temperature range	Limits			Unit	Condition
			BA3472RFVM				
			Min.	Typ.	Max.		
Input Offset Voltage ^(*4)	Vio	25°C	-	1	10	mV	Vicm=0[V], VOUT=0[V]
			-	1.5	10		VCC=5[V], VEE=0[V], Vicm=0[V], VOUT=VCC/2
Input Offset Current ^(*4)	Iio	25°C	-	6	75	nA	Vicm=0[V], VOUT=0[V]
Input Bias Current ^(*4)	Ib	25°C	-	100	500	nA	Vicm=0[V], VOUT=0[V]
Supply Current	ICC	25°C	-	4	5.5	mA	RL=∞
High Level Output Voltage	VOH	25°C	3.7	4	-	V	VCC=5[V], RL=2[kΩ]
			13.7	14	-		RL=10[kΩ]
			13.5	-	-		RL=2[kΩ]
Low Level Output Voltage	VOL	25°C	-	0.1	0.3	V	VCC=5[V], RL=2[kΩ]
			-	-14.7	-14.3		RL=10[kΩ]
			-	-	-13.5		RL=2[kΩ]
Large Signal Voltage Gain	AV	25°C	80	100	-	dB	RL ≥ 2[kΩ], VOUT=±10 [V]
Input Common-mode Voltage Range	Vicm	25°C	0	-	VCC-2.0	V	VCC=5[V], VEE=0[V], VOUT=VCC/2
Common-mode Rejection Ratio	CMRR	25°C	60	97	-	dB	Vicm=0[V], VOUT=0[V]
Power Supply Rejection Ratio	PSRR	25°C	60	97	-	dB	Vicm=0[V], VOUT=0[V]
Output Source Current ^(*5)	IOH	25°C	10	30	-	mA	VIN+=1[V], VIN-=0[V], VOUT=0[V] Only 1ch is short circuit
Output Sink Current ^(*5)	IOL	25°C	20	30	-	mA	VIN+=0[V], VIN-=1[V], VOUT=5[V] Only 1ch is short circuit
Maximum Frequency	ft	25°C	-	4	-	MHz	-
Slew Rate	SR	25°C	-	10	-	V/μs	Av=1, Vin=-10 to +10[V], RL=2[kΩ]
Channel Separation	CS	25°C	-	120	-	dB	-

(*4) Absolute value

(*5) Under high temperatures, please consider the power dissipation when selecting the output current.

When the output terminal is continuously shorted the output current reduces the internal temperature by flushing.

OBA3474 family (Unless otherwise specified VCC=+15[V], VEE=-15[V], Ta=25[°C])

Parameter	Symbol	Temperature range	Limits			Unit	Condition
			BA3474F/FV				
			Min.	Typ.	Max.		
Input Offset Voltage ^(*6)	Vio	25°C	-	1	10	mV	Vicm=0[V],VOUT=0[V]
			-	1.5	10		VCC=5[V],VEE=0[V], Vicm=0[V] VOUT=VCC/2
Input Offset Current ^(*6)	Iio	25°C	-	6	75	nA	Vicm=0[V],VOUT=0[V]
Input Bias Current ^(*6)	Ib	25°C	-	100	500	nA	Vicm=0[V],VOUT=0[V]
Supply Current	ICC	25°C	-	8	11	mA	RL=∞
High Level Output Voltage	VOH	25°C	3.7	4	-	V	VCC=5[V],RL=2[kΩ]
			13.7	14	-		RL=10[kΩ]
			13.5	-	-		RL=2[kΩ]
Low Level Output Voltage	VOL	25°C	-	0.1	0.3	V	VCC=5[V],RL=2[kΩ]
			-	-14.7	-14.3		RL=10[kΩ]
			-	-	-13.5		RL=2[kΩ]
Large Signal Voltage Gain	AV	25°C	80	100	-	dB	RL ≥ 2[kΩ], VOUT=±10 [V]
Input Common-mode Voltage Range	Vicm	25°C	0	-	VCC-2.0	V	VCC=5[V],VEE=0[V], VOUT=VCC/2
Common-mode Rejection Ratio	CMRR	25°C	60	97	-	dB	Vicm=0[V],VOUT=0[V]
Power Supply Rejection Ratio	PSRR	25°C	60	97	-	dB	Vicm=0[V],VOUT=0[V]
Output Source Current ^(*7)	IOH	25°C	10	30	-	mA	VIN+=1[V],VIN-=0[V], VOUT=0[V] Only 1ch is short circuit
Output Sink Current ^(*7)	IOL	25°C	20	30	-	mA	VIN+=0[V],VIN-=1[V], VOUT=5[V] Only 1ch is short circuit
Maximum Frequency	ft	25°C	-	4	-	MHz	-
Slew Rate	SR	25°C	-	10	-	V/μs	Av=1,Vin=-10 to +10[V], RL=2[kΩ]
Channel Separation	CS	25°C	-	120	-	dB	-

(*6) Absolute value

(*7) Under high temperatures, please consider the power dissipation when selecting the output current.

When the output terminal is continuously shorted the output current reduces the internal temperature by flushing.

OBA3474R family (Unless otherwise specified VCC=+15[V], VEE=-15[V], Ta=25[°C])

Parameter	Symbol	Temperature range	Limits			Unit	Condition
			BA3474RFV				
			Min.	Typ.	Max.		
Input Offset Voltage ^(*8)	Vio	25°C	-	1	10	mV	Vicm=0[V],VOUT=0[V]
			-	1.5	10		VCC=5[V],VEE=0[V],Vicm=0[V], VOUT=VCC/2
Input Offset Current ^(*8)	lio	25°C	-	6	75	nA	Vicm=0[V],VOUT=0[V]
Input Bias Current ^(*8)	Ib	25°C	-	100	500	nA	Vicm=0[V],VOUT=0[V]
Supply Current	ICC	25°C	-	8	11	mA	RL=∞
High Level Output Voltage	VOH	25°C	3.7	4	-	V	VCC=5[V],RL=2[kΩ]
			13.7	14	-		RL=10[kΩ]
			13.5	-	-		RL=2[kΩ]
Low Level Output Voltage	VOL	25°C	-	0.1	0.3	V	VCC=5[V],RL=2[kΩ]
			-	-14.7	-14.3		RL=10[kΩ]
			-	-	-13.5		RL=2[kΩ]
Large Signal Voltage Gain	AV	25°C	80	100	-	dB	RL ≥ 2[kΩ],VOUT=±10 [V]
Input Common-mode Voltage Range	Vicm	25°C	0	-	VCC-2.0	V	VCC=5[V],VEE=0[V], VOUT=VCC/2
Common-mode Rejection Ratio	CMRR	25°C	60	97	-	dB	Vicm=0[V],VOUT=0[V]
Power Supply Rejection Ratio	PSRR	25°C	60	97	-	dB	Vicm=0[V],VOUT=0[V]
Output Source Current ^(*9)	IOH	25°C	10	30	-	mA	VIN+=1[V],VIN-=0[V],VOUT=0[V], Only 1ch is short circuit
Output Sink Current ^(*9)	IOL	25°C	20	30	-	mA	VIN+=0[V],VIN-=1[V],VOUT=5[V], Only 1ch is short circuit
Maximum Frequency	ft	25°C	-	4	-	MHz	-
Slew Rate	SR	25°C	-	10	-	V/μs	Av=1,Vin=-10 to +10[V],RL=2[kΩ]
Channel Separation	CS	25°C	-	120	-	dB	-

(*8) Absolute value

(*9) Under high temperatures, please consider the power dissipation when selecting the output current.

When the output terminal is continuously shorted the output current reduces the internal temperature by flushing.

●Reference Data BA3472 family

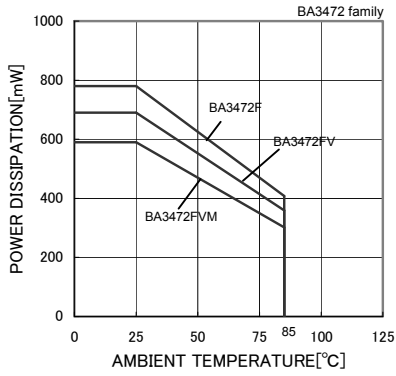

Fig.1 Derating Curve

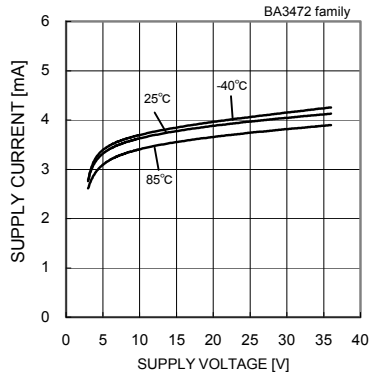

Fig.2 Supply Current - Supply Voltage

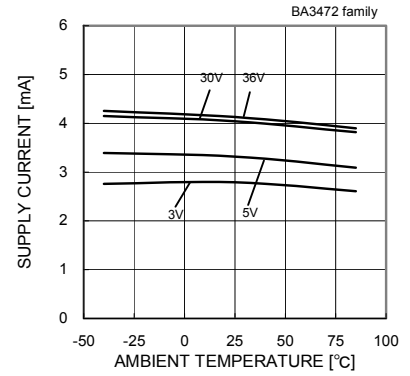

Fig.3 Supply Current - Ambient Temperature

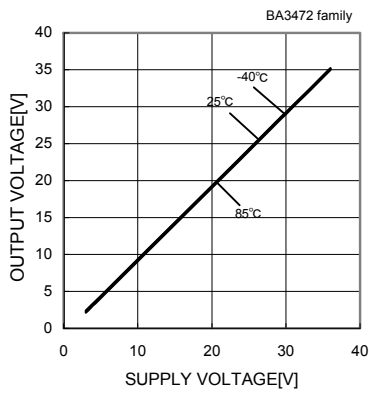

Fig.4 High level Output Voltage - Supply Voltage (RL=10[kΩ])

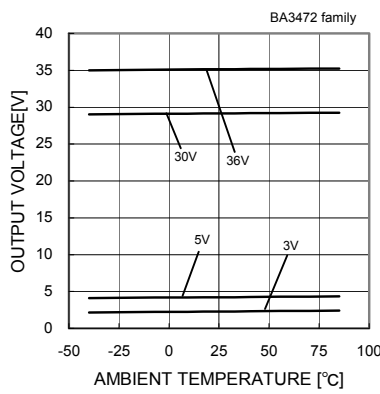

Fig.5 High level Output Voltage - Ambient Temperature (RL=10[kΩ])

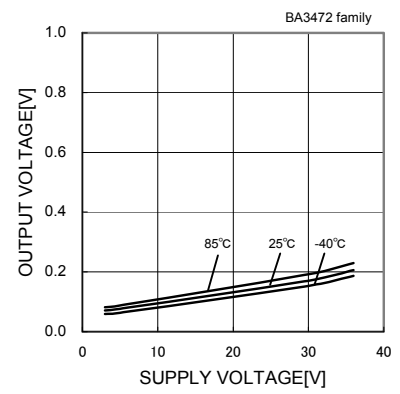

Fig.6 Low level Output Voltage - Supply Voltage (RL=10[kΩ])

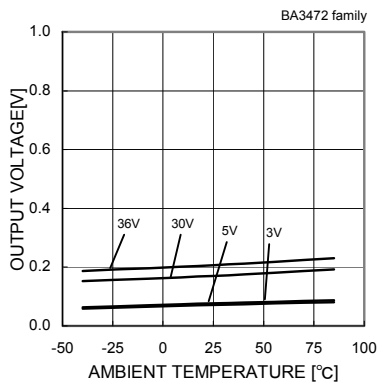

Fig.7 Low level Output Voltage - Ambient Temperature (RL=10[kΩ])

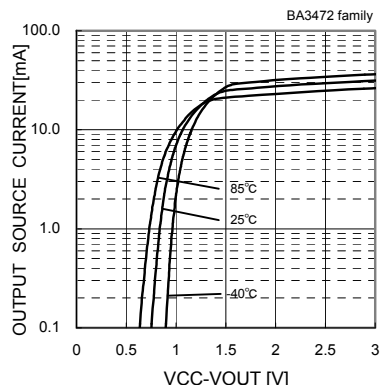

Fig.8 Output Source Current - (VCC-VOUT) (VCC/VEE=5[V]/0[V])

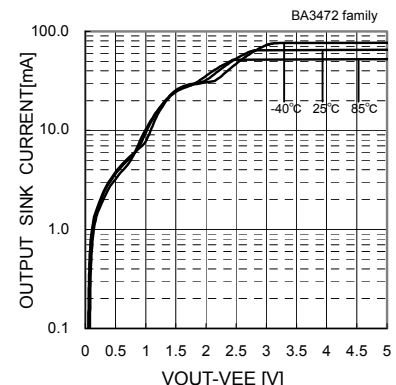

Fig.9 Output Source Current - (VOUT-VEE) (VCC/VEE=5[V]/0[V])

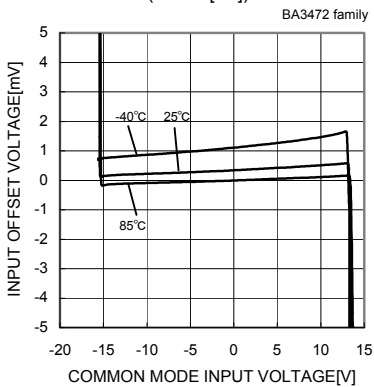

Fig.10 Input Offset Voltage - Common Mode Input Voltage (VCC/VEE=15[V]/-15[V])

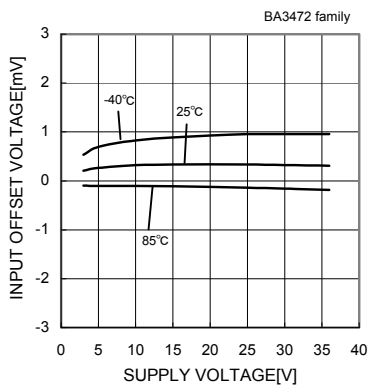

Fig.11 Input Offset Voltage - Supply Voltage

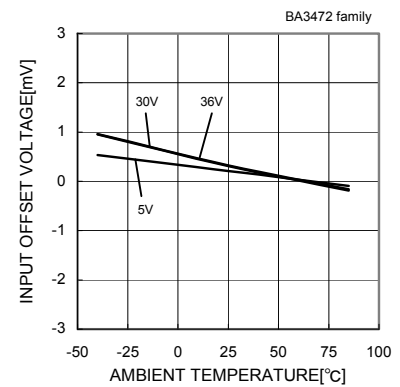

Fig.12 Input Offset Voltage - Ambient Temperature

(*)The data above is ability value of sample, it is not guaranteed

●Reference Data BA3472 family

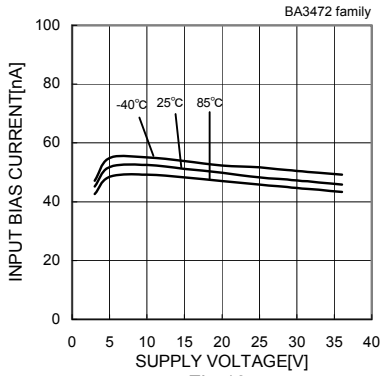

Fig.13
Input Bias Current - Supply voltage

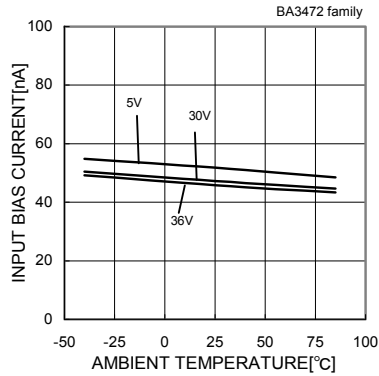

Fig.14
Input Bias Current - Ambient Temperature

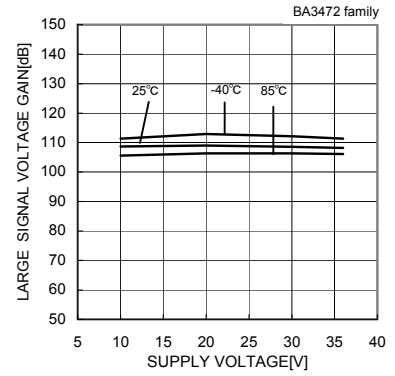

Fig.15
Large Signal Voltage Gain
-Supply Voltage

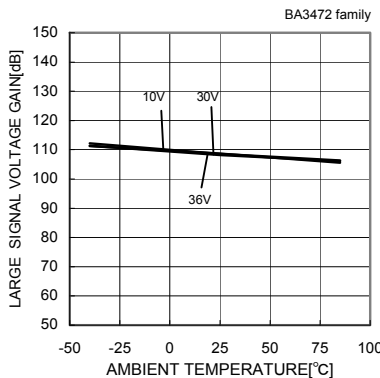

Fig.16
Large Signal Voltage Gain
-Ambient Temperature

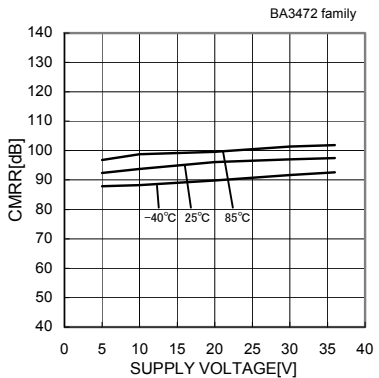

Fig.17
Common Mode Rejection Ratio
-Supply Voltage

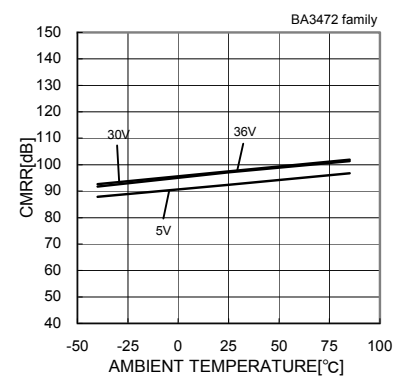

Fig.18
Common Mode Rejection Ratio
-Ambient Temperature

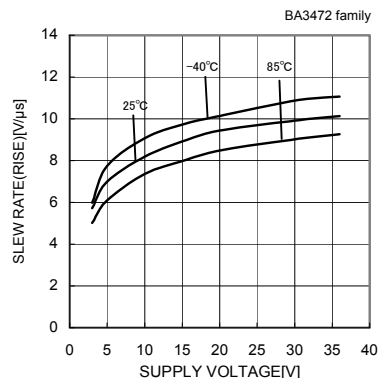

Fig.19
Slew Rate L-H - Supply Voltage
(RL=10[kΩ])

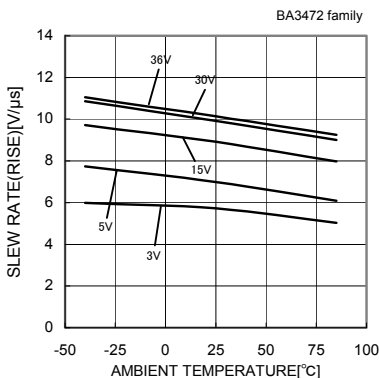

Fig.20
Slew Rate L-H - Ambient Temperature
(RL=10[kΩ])

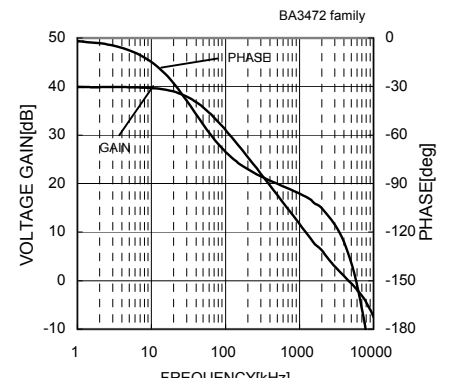

Fig.21
Voltage Gain - Frequency
(VCC=7.5[V]/-7.5[V], Av=40[dB],
RL=2[kΩ], CL=100[pF], Ta=25[°C])

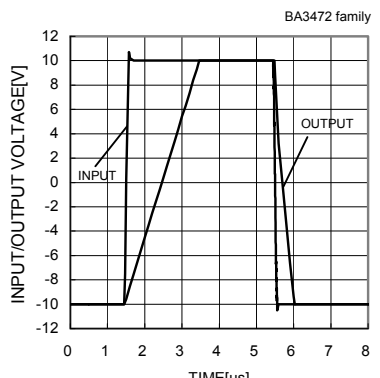

Fig.22
Input / Output Voltage - Time
(VCC/VEE=15[V]/-15[V], Av=0[dB],
RL=2[kΩ], CL=100[pF], Ta=25[°C])

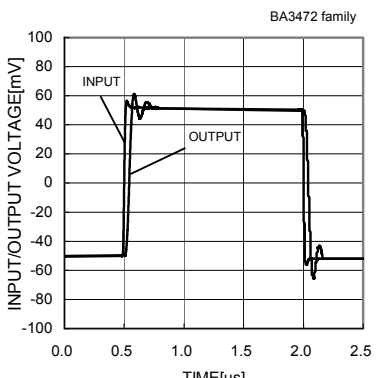

Fig.23
Input / Output Voltage - Time
(VCC/VEE=15[V]/-15[V], Av=0[dB],
RL=2[kΩ], CL=100[pF], Ta=25[°C])

(*)The data above is ability value of sample, it is not guaranteed

●Reference Data BA3474 family

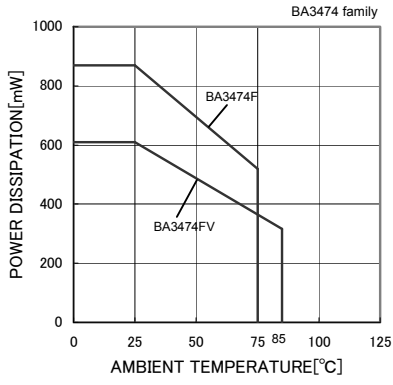

Fig.24
Derating Curve

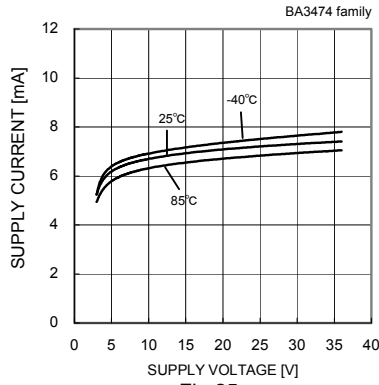

Fig.25
Supply Current - Supply Voltage

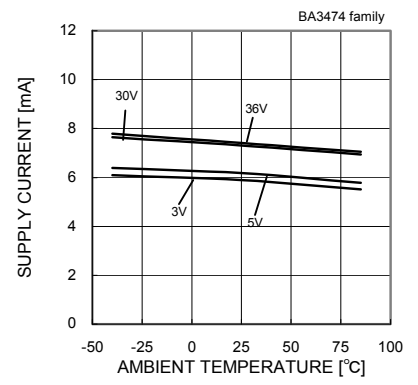

Fig.26
Supply Current - Ambient Temperature

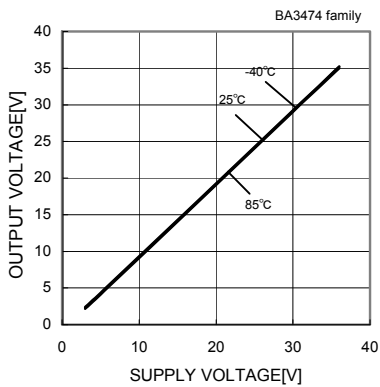

Fig.27
High level Output Voltage
- Supply Voltage
($R_L=10[k\Omega]$)

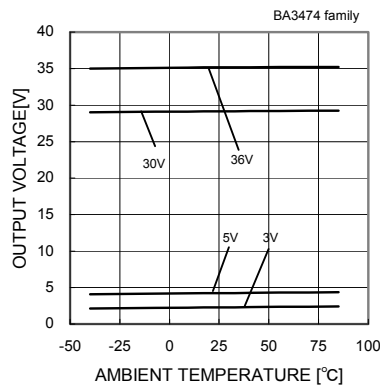

Fig.28
High level Output Voltage
- Ambient Temperature
($R_L=10[k\Omega]$)

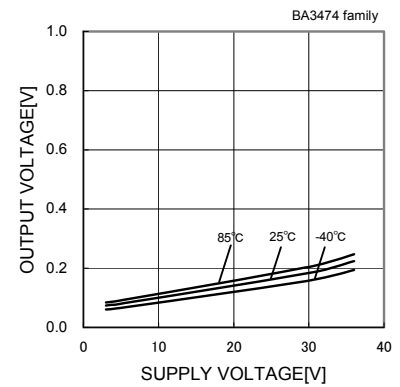

Fig.29
Low level Output Voltage
- Supply Voltage
($R_L=10[k\Omega]$)

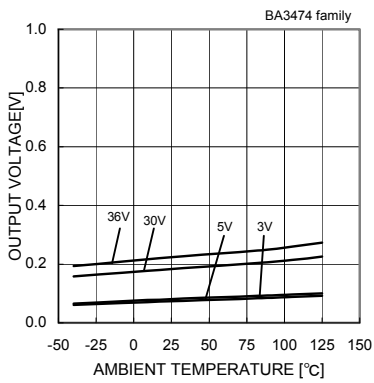

Fig.30
Low level Output Voltage
- Ambient Temperature
($R_L=10[k\Omega]$)

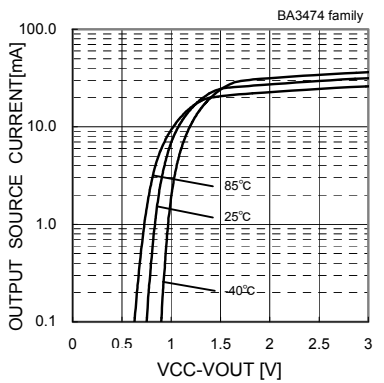

Fig.31
Output Source Current - (VCC-VOUT)
($V_{CC}/V_{EE}=5[V]/0[V]$)

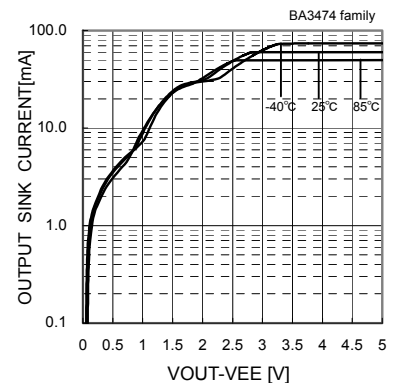

Fig.32
Output Sink Current - (VOUT-VEE)
($V_{CC}/V_{EE}=5[V]/0[V]$)

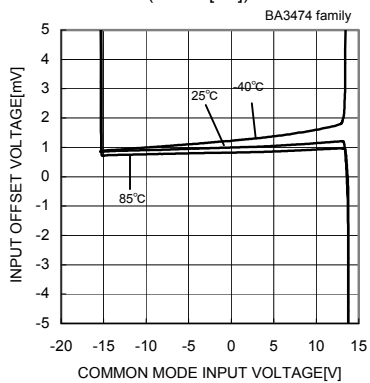

Fig.33
Input Offset Voltage
- Common Model Input Voltage
($V_{CC}/V_{EE}=15[V]/-15[V]$)

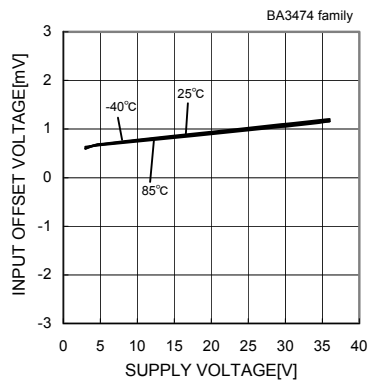

Fig.34
Input Offset Voltage - Supply voltage

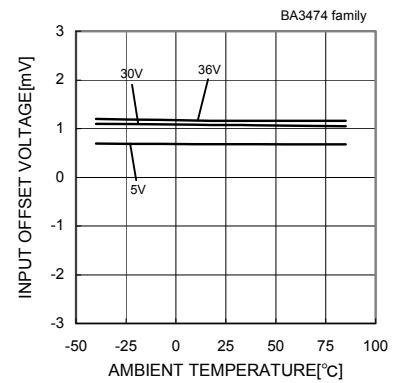

Fig.35
Input Offset Voltage - Ambient Temperature

(*)The data above is ability value of sample, it is not guaranteed

●Reference Data BA3474 family

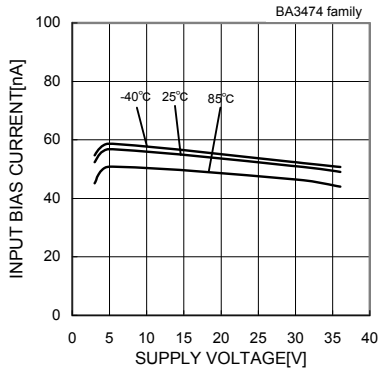

Fig.36
Input Bias Current - Supply voltage

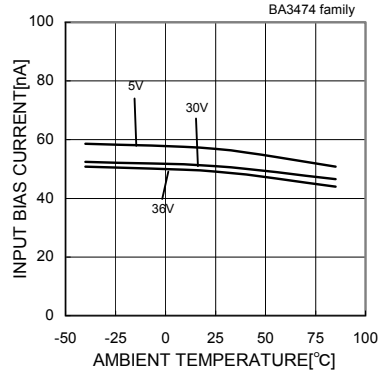

Fig.37
Input Bias Current - Ambient Temperature

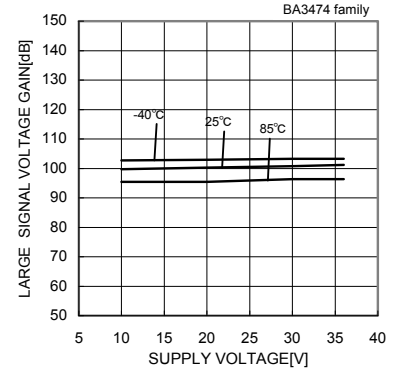

Fig.38
Large Signal Voltage Gain - Supply Voltage

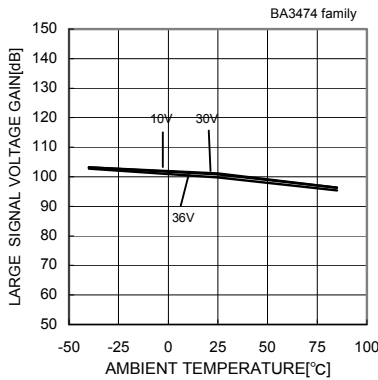

Fig.39
Large Signal Voltage Gain - Ambient Temperature

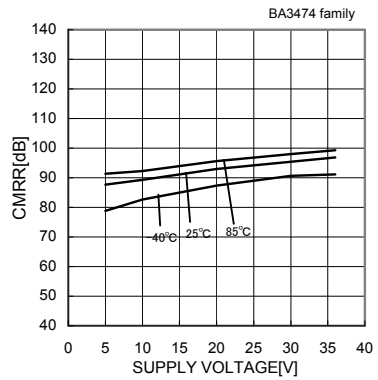

Fig.40
Common Mode Rejection Ratio - Supply Voltage

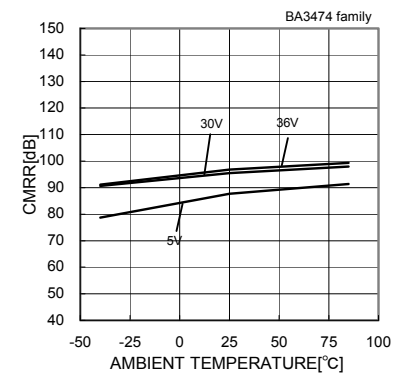

Fig.41
Common Mode Rejection Ratio - Ambient Temperature

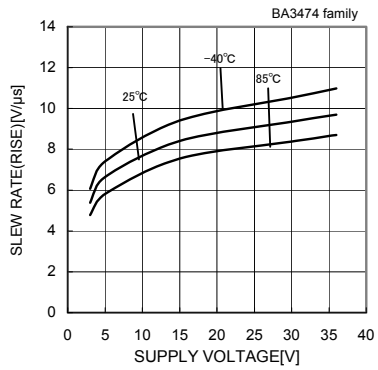

Fig.42
Slew Rate L-H - Supply Voltage
(RL=10[kΩ])

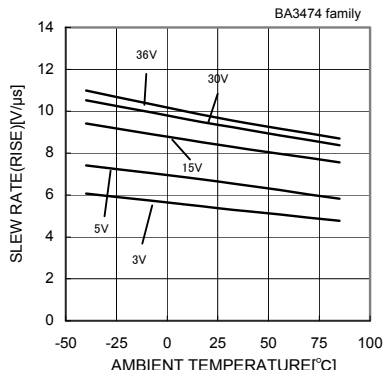

Fig.43
Slew Rate L-H - Ambient Temperature
(RL=10[kΩ])

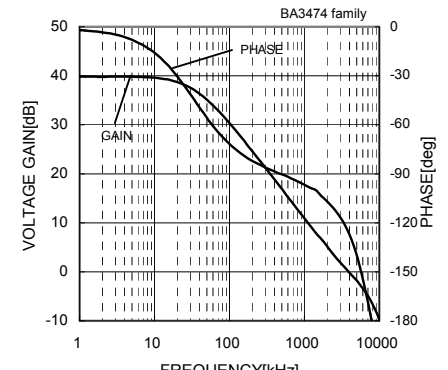

Fig.44
Voltage Gain - Frequency
(VCC=7.5[V]/-7.5[V], Av=40[dB],
RL=2[kΩ], CL=100[pF], Ta=25[°C])

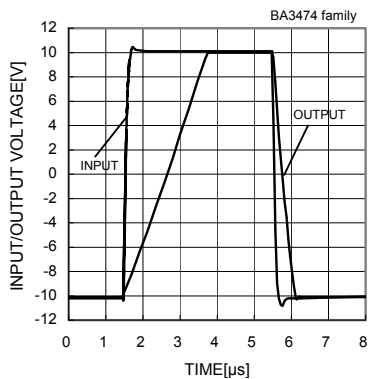

Fig.45
Input / Output Voltage - Time
(VCC/VEE=15[V]/-15[V], Av=0[dB],
RL=2[kΩ], CL=100[pF], Ta=25[°C])

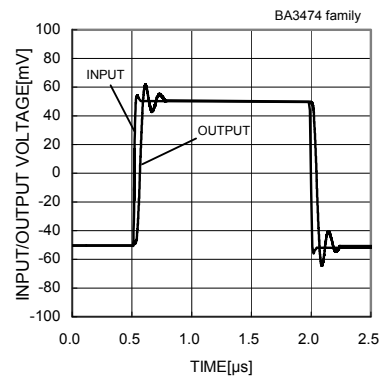

Fig.46
Input / Output Voltage - Time
(VCC/VEE=15[V]/-15[V], Av=0[dB],
RL=2[kΩ], CL=100[pF], Ta=25[°C])

(*)The data above is ability value of sample, it is not guaranteed

●Reference Data BA3472R family

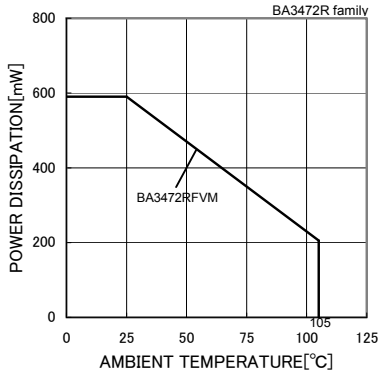

Fig.47 Derating Curve

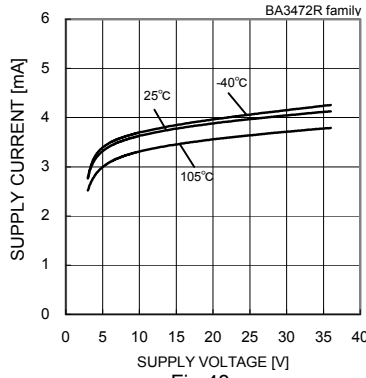

Fig.48 Supply Current - Supply Voltage

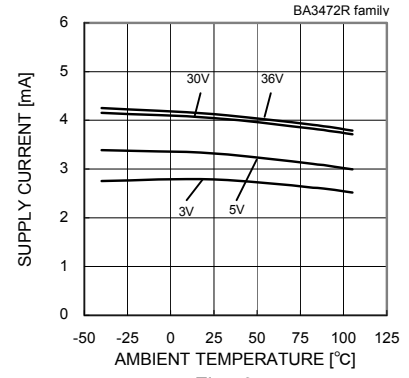

Fig.49 Supply Current - Ambient Temperature

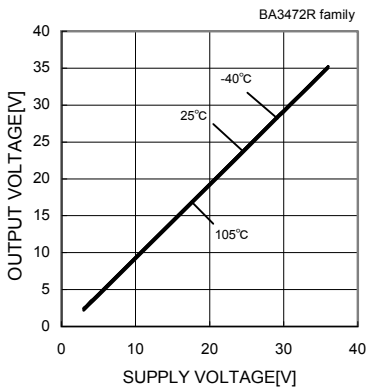

Fig.50 High level Output Voltage - Supply Voltage (RL=10[kΩ])

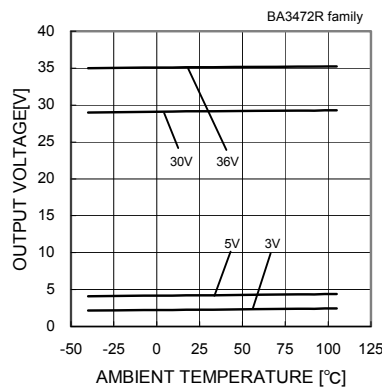

Fig.51 High level Output Voltage - Ambient Temperature (RL=10[kΩ])

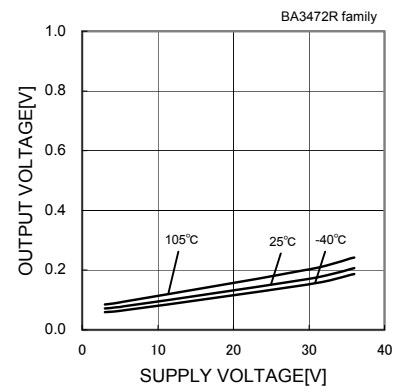

Fig.52 Low level Output Voltage - Supply Voltage (RL=10[kΩ])

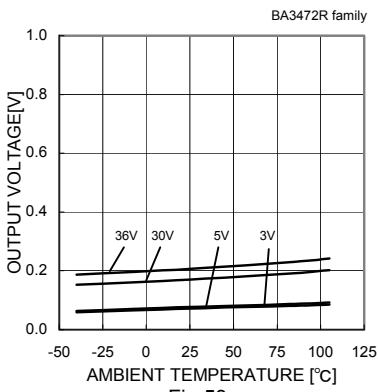

Fig.53 Low level Output Voltage - Ambient Temperature (RL=10[kΩ])

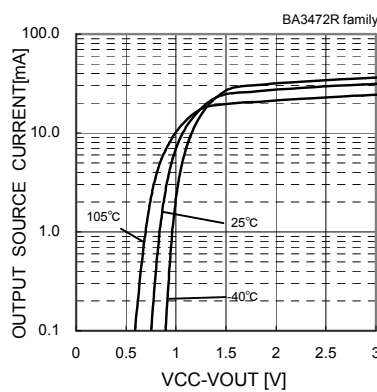

Fig.54 Output Source Current - (VCC-VOUT) (VCC/VEE=5[V]/0[V])

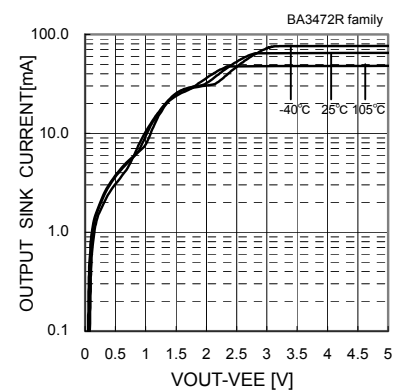

Fig.55 Output Source Current - (VOUT-VEE) (VCC/VEE=5[V]/0[V])

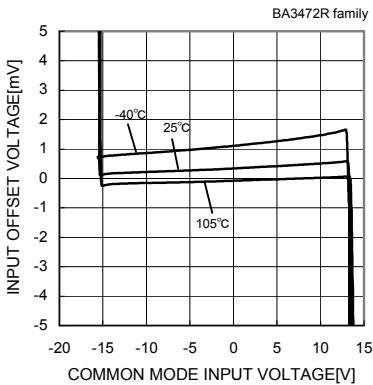

Fig.56 Input Offset Voltage - Common Mode Input Voltage (VCC/VEE=15[V]/-15[V])

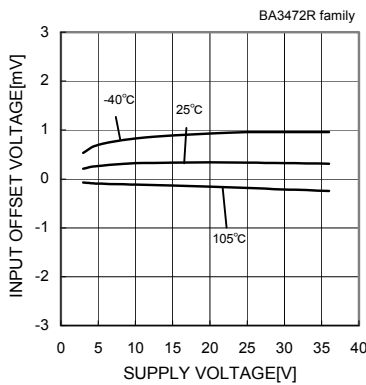

Fig.57 Input Offset Voltage - Supply voltage

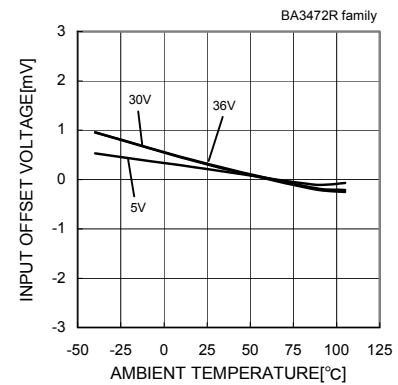

Fig.58 Input Offset Voltage - Ambient Temperature

(*)The data above is ability value of sample, it is not guaranteed

●Reference Data BA3472R family

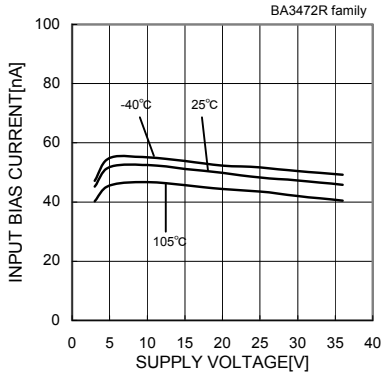

Fig.59
Input Bias Current - Supply Voltage

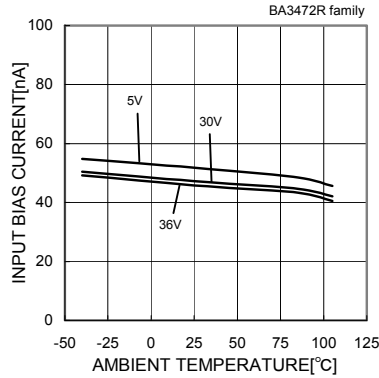

Fig.60
Input Bias Current - Ambient Temperature

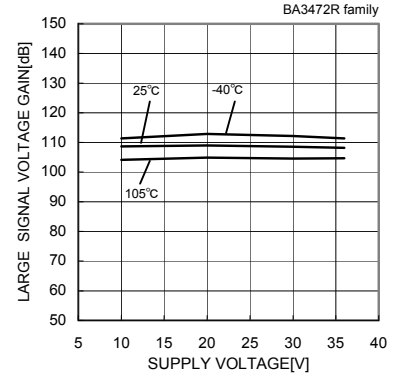

Fig.61
Large Signal Voltage Gain - Supply Voltage

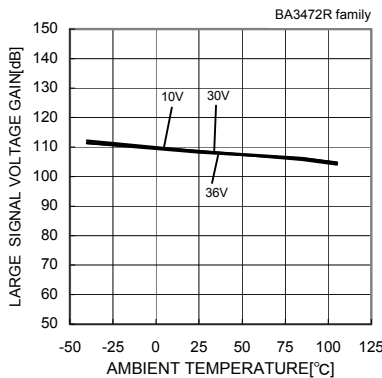

Fig.62
Large Signal Voltage Gain - Ambient Temperature

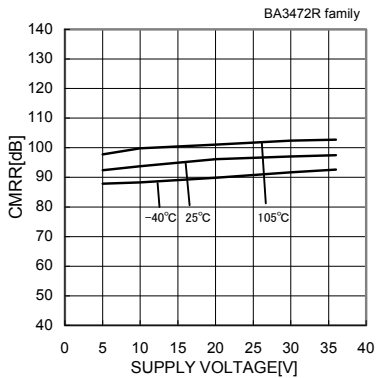

Fig.63
Common Mode Rejection Ratio - Supply Voltage

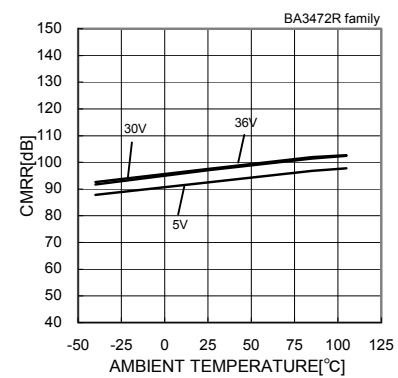

Fig.64
Common Mode Rejection Ratio - Ambient Temperature

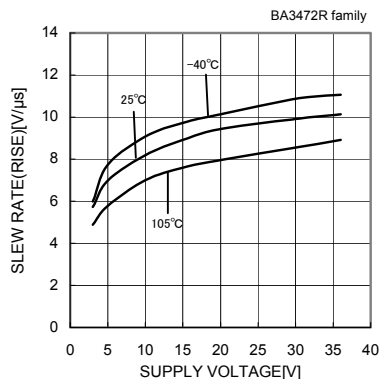

Fig.65
Slew Rate L-H - Supply Voltage
(RL=10[kΩ])

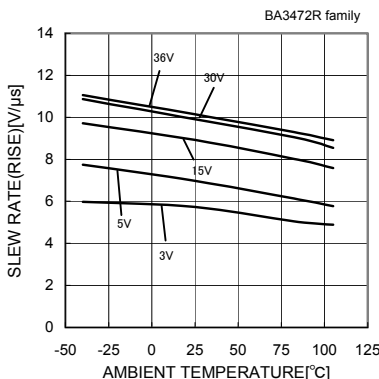

Fig.66
Slew Rate L-H - Ambient Temperature
(RL=10[kΩ])

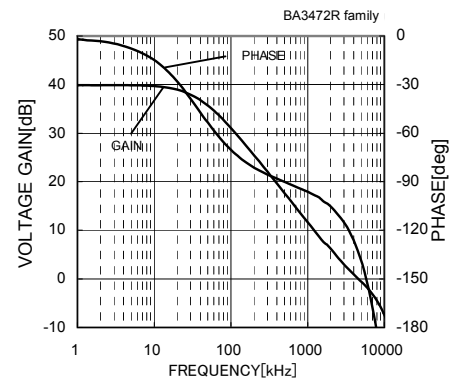

Fig.67
Voltage Gain - Frequency
(VCC=7.5[V]/-7.5[V], Av=40[dB],
RL=2[kΩ], CL=100[pF], Ta=25[°C])

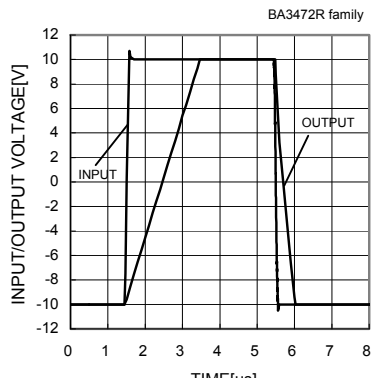

Fig.68
Input / Output Voltage - Time
(VCC/VEE=15[V]/-15[V], Av=0[dB],
RL=2[kΩ], CL=100[pF], Ta=25[°C])

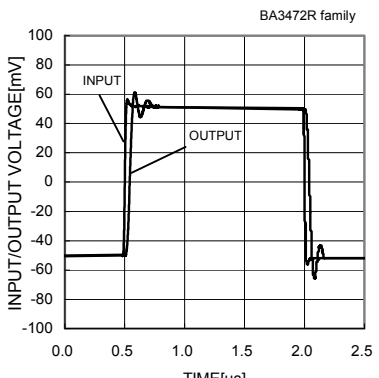

Fig.69
Input / Output Voltage - Time
(VCC/VEE=15[V]/-15[V], Av=0[dB],
RL=2[kΩ], CL=100[pF], Ta=25[°C])

(*)The data above is ability value of sample, it is not guaranteed

●Reference Data BA3474R family

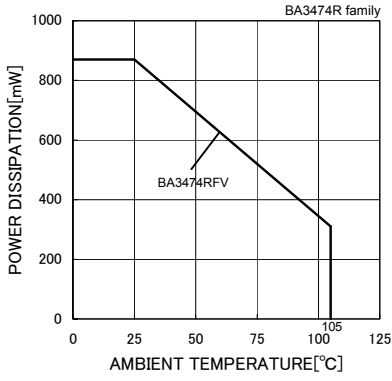

Fig.70
Derating Curve

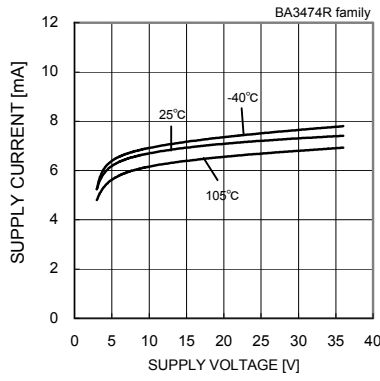

Fig.71
Supply Current - Supply Voltage

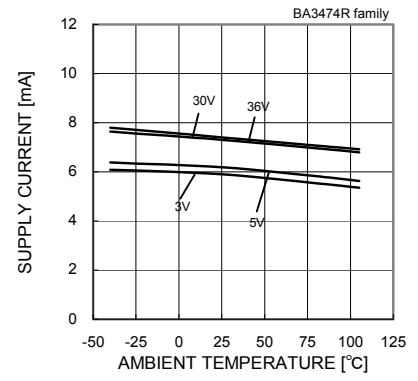

Fig.72
Supply Current - Ambient Temperature

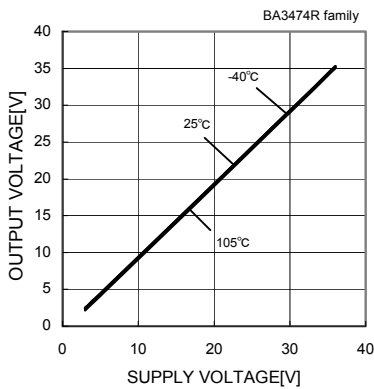

Fig.73
High level Output Voltage
- Supply Voltage
(RL=10[kΩ])

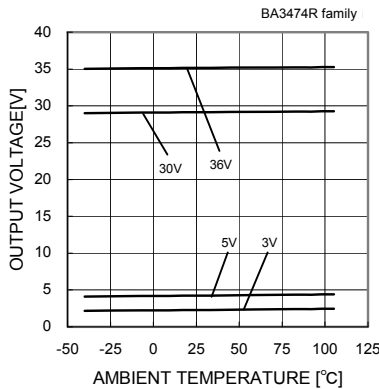

Fig.74
High level Output Voltage
- Ambient Temperature
(RL=10[kΩ])

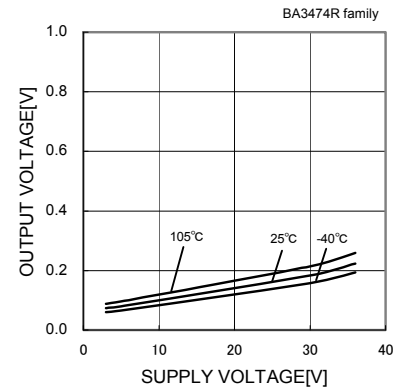

Fig.75
Low level Output Voltage
- Supply Voltage
(RL=10[kΩ])

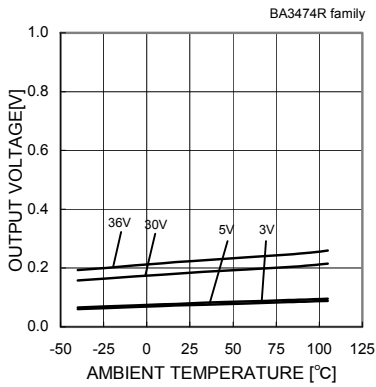

Fig.76
Low level Output Voltage
- Ambient Temperature
(RL=10[kΩ])

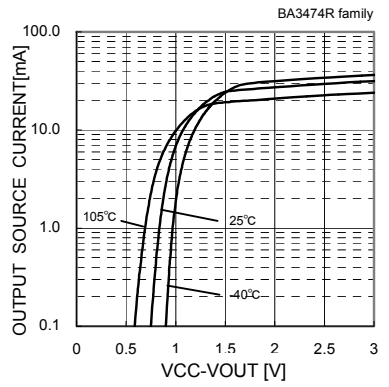

Fig.77
Output Source Current - (VCC-VOUT)
(VCC/VEE=5[V]/0[V])

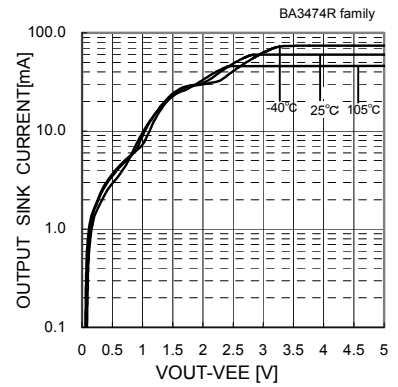

Fig.78
Output Source Current - (VOUT-VEE)
(VCC/VEE=5[V]/0[V])

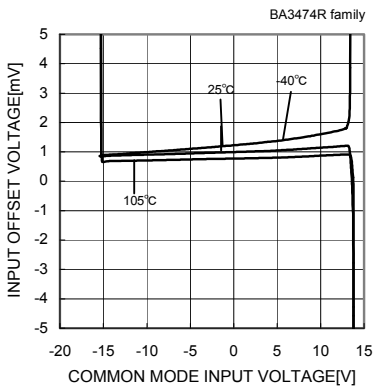

Fig.79
Input Offset Voltage
- Common Model Input Voltage
(VCC/VEE=15[V]/-15[V])

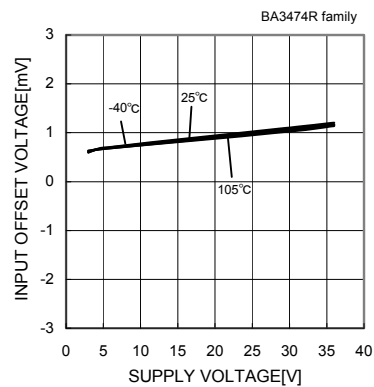

Fig.80
Input Offset Voltage - Supply voltage

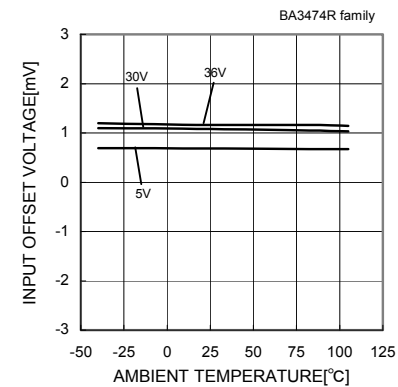
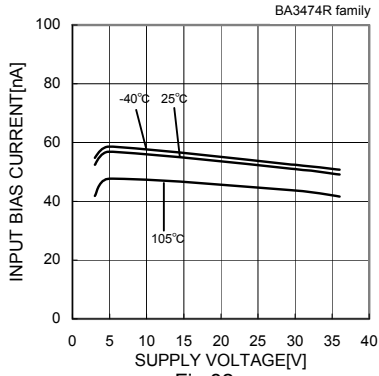

Fig.81
Input Offset Voltage - Ambient Temperature

(*)The data above is ability value of sample, it is not guaranteed

●Reference Data BA3474R family



Input Bias Current - Supply voltage

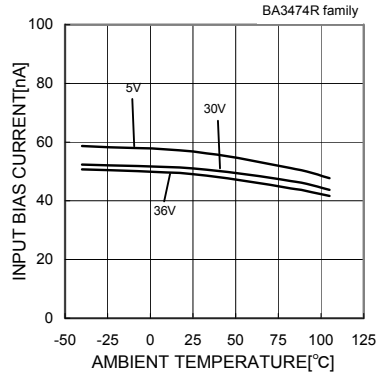

Input Bias Current - Ambient Temperature

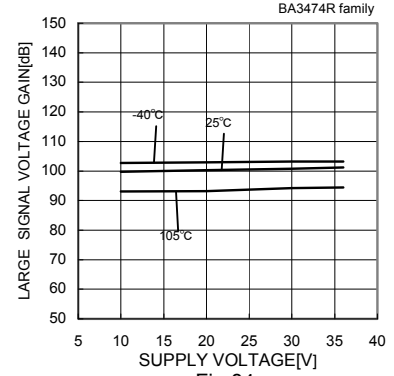

Large Signal Voltage Gain - Supply Voltage

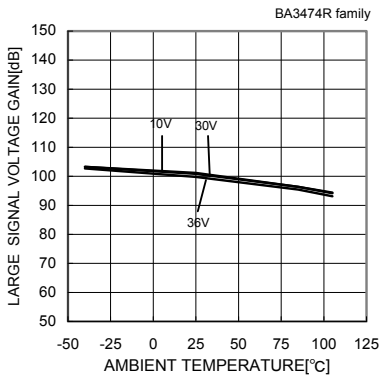

Large Signal Voltage Gain - Ambient Temperature

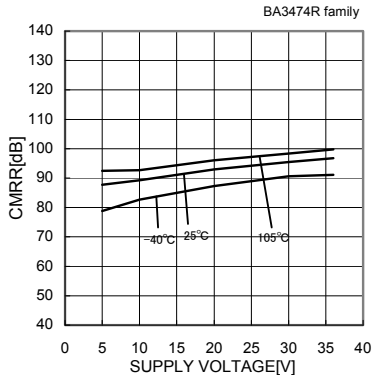

Common Mode Rejection Ratio - Supply Voltage

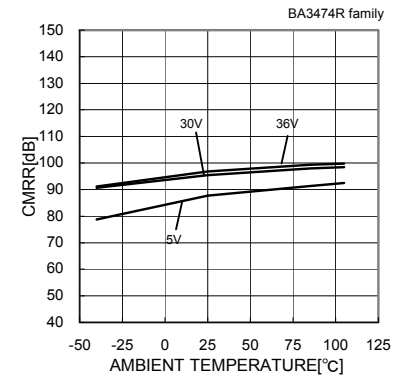

Common Mode Rejection Ratio - Ambient Temperature

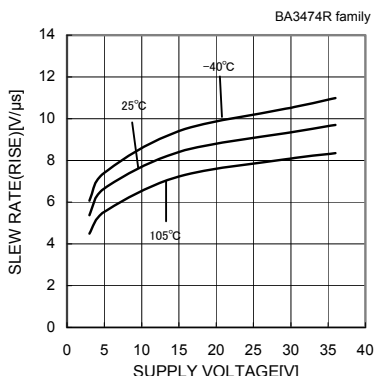

Slew Rate L-H - Supply Voltage (RL=10[kΩ])

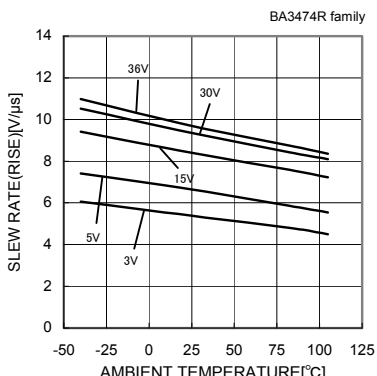

Slew Rate L-H - Ambient Temperature (RL=10[kΩ])

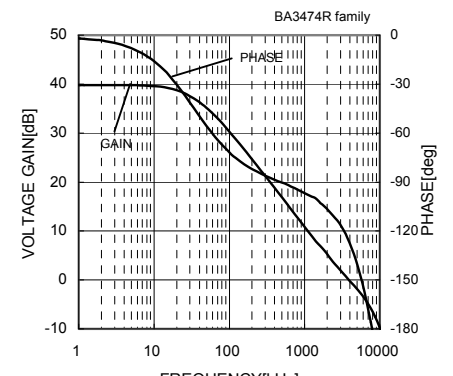

Voltage Gain - Frequency (VCC=7.5[V], VEE=-7.5[V], Av=40[dB], RL=2[kΩ], CL=100[pF], Ta=25[°C])

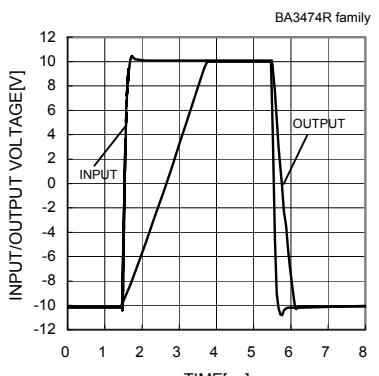

Input / Output Voltage - Time (VCC/VEE=15[V]/-15[V], Av=0[dB], RL=2[kΩ], CL=100[pF], Ta=25[°C])

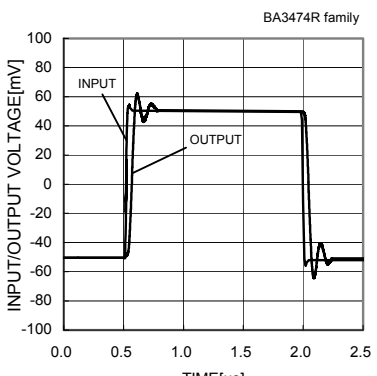

Input / Output Voltage - Time (VCC/VEE=15[V]/-15[V], Av=0[dB], RL=2[kΩ], CL=100[pF], Ta=25[°C])

(*)The data above is ability value of sample, it is not guaranteed

● Schematic diagram

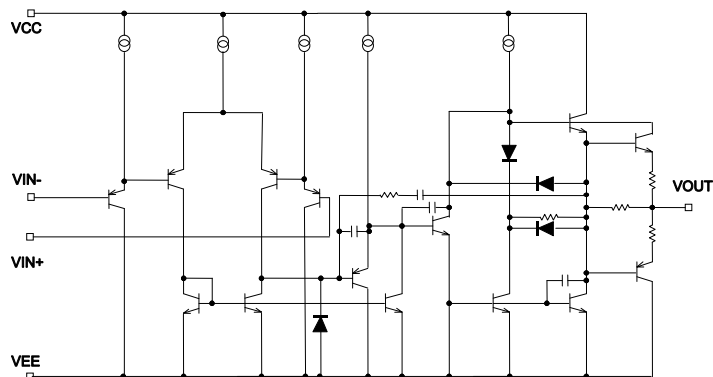

Fig.93 Schematic diagram (one channel only)

● Test circuit 1 NULL method

VCC, VEE, EK, Vicm Unit : [V]

Parameter	VF	S1	S2	S3	VCC	VEE	EK	Vicm	Calculation
Input Offset Voltage	VF1	ON	ON	OFF	15	-15	0	0	1
Input Offset Current	VF2	OFF	OFF	OFF	15	-15	0	0	2
Input Bias Current	VF3	OFF	ON	OFF	15	-15	0	0	3
	VF4	ON	OFF						
Large Signal Voltage Gain	VF5	ON	ON	ON	15	-15	+10	0	4
	VF6				15	-15	-10	0	
Common-mode Rejection Ratio (Input Common-mode Voltage Range)	VF7	ON	ON	OFF	15	-15	0	-15	5
	VF8				15	-15	0	13	
Power Supply Rejection Ratio	VF9	ON	ON	OFF	2	-2	0	0	6
	VF10				18	-18	0	0	

—Calculation—

1. Input Offset Voltage (Vio)

$$V_{io} = \frac{|VF1|}{1 + R_f / R_s} \text{ [V]}$$

2. Input Offset Current (Iio)

$$I_{io} = \frac{|VF2 - VF1|}{R_i \times (1 + R_f / R_s)} \text{ [A]}$$

3. Input Bias Current (Ib)

$$I_b = \frac{|VF4 - VF3|}{2 \times R_i \times (1 + R_f / R_s)} \text{ [A]}$$

4. Large Signal Voltage Gain (Av)

$$A_v = 20 \times \text{Log} \frac{\Delta E_K \times (1 + R_f / R_s)}{|VF5 - VF6|} \text{ [dB]}$$

5. Common-mode Rejection Ratio (CMRR)

$$\text{CMRR} = 20 \times \text{Log} \frac{\Delta V_{icm} \times (1 + R_f / R_s)}{|VF8 - VF7|} \text{ [dB]}$$

6. Power Supply Rejection Ratio (PSRR)

$$\text{PSRR} = 20 \times \text{Log} \frac{\Delta V_{cc} \times (1 + R_f / R_s)}{|VF10 - VF9|} \text{ [dB]}$$

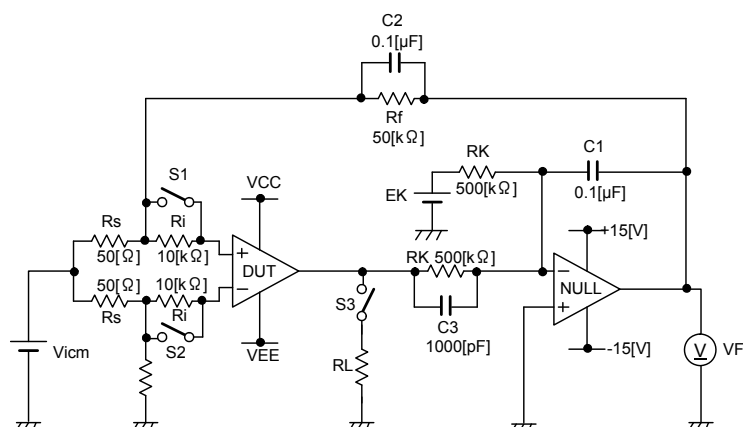

Fig.94 Test circuit 1 (one channel only)

● Test circuit2 switch condition

SW No.	SW 1	SW 2	SW 3	SW 4	SW 5	SW 6	SW 7	SW 8	SW 9	SW 10	SW 11	SW 12	SW 13	SW 14
Supply Current	OFF	OFF	OFF	ON	OFF	ON	OFF	OFF	OFF	OFF	OFF	OFF	OFF	OFF
High Level Output Voltage	OFF	OFF	ON	OFF	OFF	ON	OFF	OFF	ON	OFF	OFF	OFF	ON	OFF
Low Level Output Voltage	OFF	OFF	ON	OFF	OFF	ON	OFF	OFF	OFF	OFF	OFF	OFF	ON	OFF
Output Source Current	OFF	OFF	ON	OFF	OFF	ON	OFF	OFF	OFF	OFF	OFF	OFF	OFF	ON
Output Sink Current	OFF	OFF	ON	OFF	OFF	ON	OFF	OFF	OFF	OFF	OFF	OFF	OFF	ON
Slew Rate	OFF	OFF	OFF	ON	OFF	OFF	OFF	ON	ON	ON	OFF	OFF	OFF	OFF
Gain Bandwidth Product	OFF	ON	OFF	OFF	ON	ON	OFF	OFF	ON	ON	OFF	OFF	OFF	OFF
Equivalent Input Noise Voltage	ON	OFF	OFF	OFF	ON	ON	OFF	OFF	OFF	OFF	ON	OFF	OFF	OFF

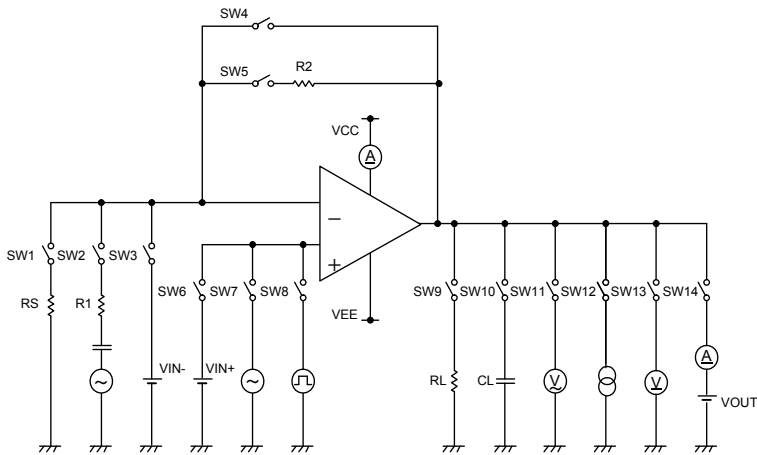

Fig.95 Test circuit 2 (one channel only)

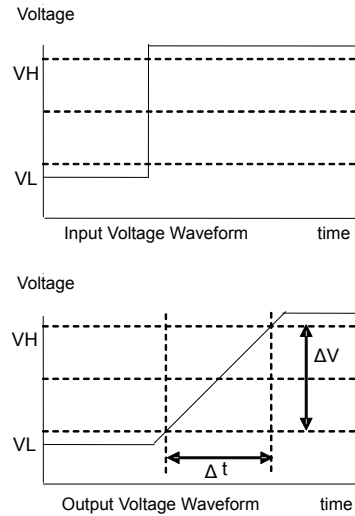

Fig.96 Slew rate input output wave

● Test circuit 3 Channel separation

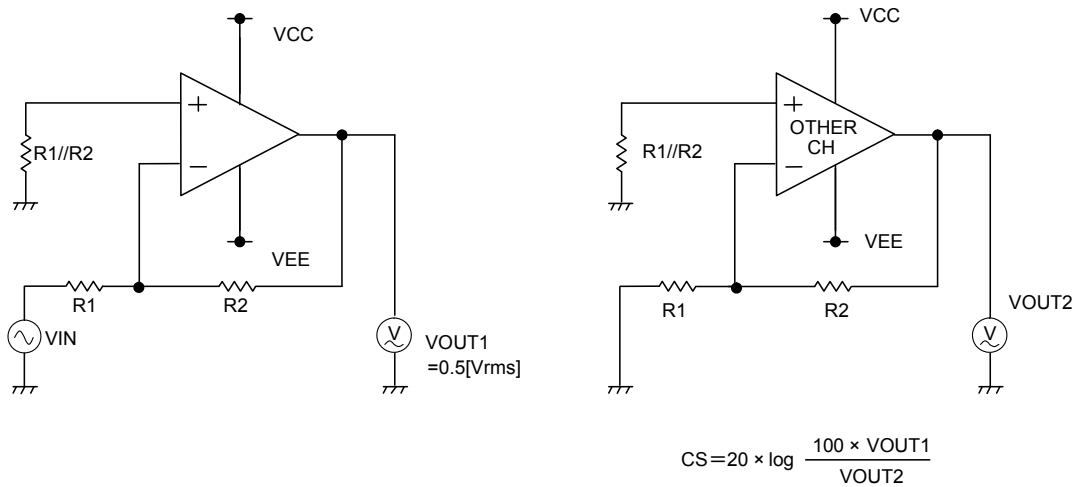

Fig.97 Test circuit 3

●Notes for use

1) Unused circuits

When there are unused circuits it is recommended that they are connected as in Fig.98, setting the non-inverting input terminal to a potential within input common-mode voltage range (V_{icm}).

2) Input terminal voltage

Applying GND + 36V to the input terminal is possible without causing deterioration of the electrical characteristics or destruction, irrespective of the supply voltage. However, this does not ensure normal circuit operation. Please note that the circuit operates normally only when the input voltage is within the common mode input voltage range of the electric characteristics.

3) Power supply (single / dual)

The op-amp operates when the specified voltage supplied is between VCC and VEE. Therefore, the single supply op-amp can be used as dual supply op-amp as well.

4) Power dissipation P_d

Using the unit in excess of the rated power dissipation may cause deterioration in electrical characteristics due to a rise in chip temperature, including reduced current capability. Therefore, please take into consideration the power dissipation (P_d) under actual operating conditions and apply a sufficient margin in thermal design. Refer to the thermal derating curves for more information.

5) Short-circuit between pins and erroneous mounting

Incorrect mounting may damage the IC. In addition, the presence of foreign particles between the outputs, the output and the power supply, or the output and GND may result in IC destruction.

6) Operation in a strong electromagnetic field

Operation in a strong electromagnetic field may cause malfunctions.

7) Radiation

This IC is not designed to withstand radiation.

8) IC handling

Applying mechanical stress to the IC by deflecting or bending the board may cause fluctuations in the electrical characteristics due to piezoelectric (piezo) effects.

9) Board inspection

Connecting a capacitor to a pin with low impedance may stress the IC. Therefore, discharging the capacitor after every process is recommended. In addition, when attaching and detaching the jig during the inspection phase, ensure that the power is turned OFF before inspection and removal. Furthermore, please take measures against ESD in the assembly process as well as during transportation and storage.

10) Output capacitor

Discharge of the external output capacitor to VCC is possible via internal parasitic elements when VCC is shorted to VEE, causing damage to the internal circuitry due to thermal stress. Therefore, when using this IC in circuits where oscillation due to output capacitive load does not occur, such as in voltage comparators, use an output capacitor with a capacitance less than 0.1 μ F.

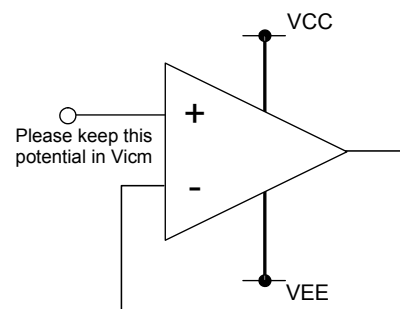

Fig.98 Unused circuit example

●Derating curves

Power dissipation(total loss) indicates the power that can be consumed by IC at Ta=25°C(normal temperature). IC is heated when it consumed power, and the temperature of IC chip becomes higher than ambient temperature. The temperature that can be accepted by IC chip depends on circuit configuration, manufacturing process, and consumable power is limited. Power dissipation is determined by the temperature allowed in IC chip (maximum junction temperature) and thermal resistance of package (heat dissipation capability). The maximum junction temperature is typically equal to the maximum value in the storage temperature range. Heat generated by consumed power of IC radiates from the mold resin or lead frame of the package. The parameter which indicates this heat dissipation capability(hardness of heat release)is called thermal resistance, represented by the symbol θ_{ja} [°C/W].The temperature of IC inside the package can be estimated by this thermal resistance. Fig.99 (a) shows the model of thermal resistance of the package. Thermal resistance θ_{ja} , ambient temperature Ta, junction temperature Tj, and power dissipation Pd can be calculated by the equation below:

$$\theta_{ja} = (T_j - T_a) / P_d \quad [^{\circ}\text{C}/\text{W}] \quad \dots \dots \quad (I)$$

Derating curve in Fig.99 (b) indicates power that can be consumed by IC with reference to ambient temperature. Power that can be consumed by IC begins to attenuate at certain ambient temperature. This gradient is determined by thermal resistance θ_{ja} . Thermal resistance θ_{ja} depends on chip size, power consumption, package, ambient temperature, package condition, wind velocity, etc even when the same of package is used. Thermal reduction curve indicates a reference value measured at a specified condition. Fig.100(c) ~ (f) shows a derating curve for an example of BA3472, BA3474, BA3472R, BA3474R.

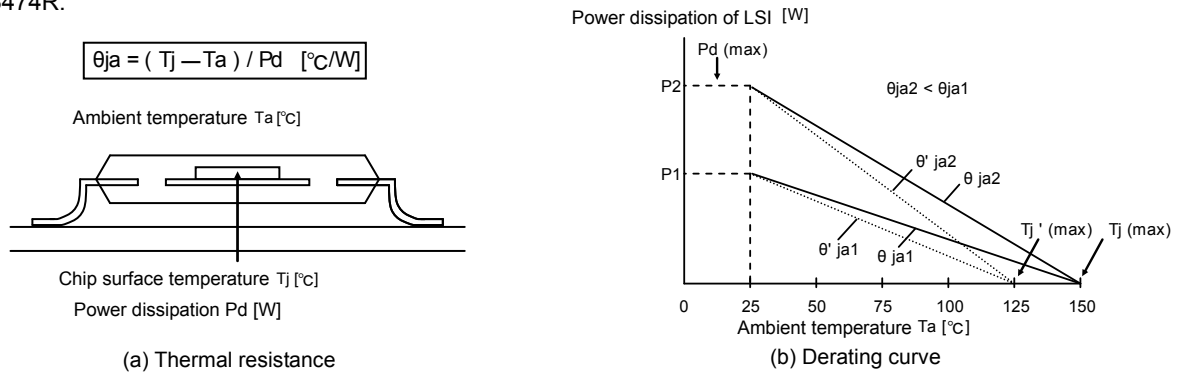
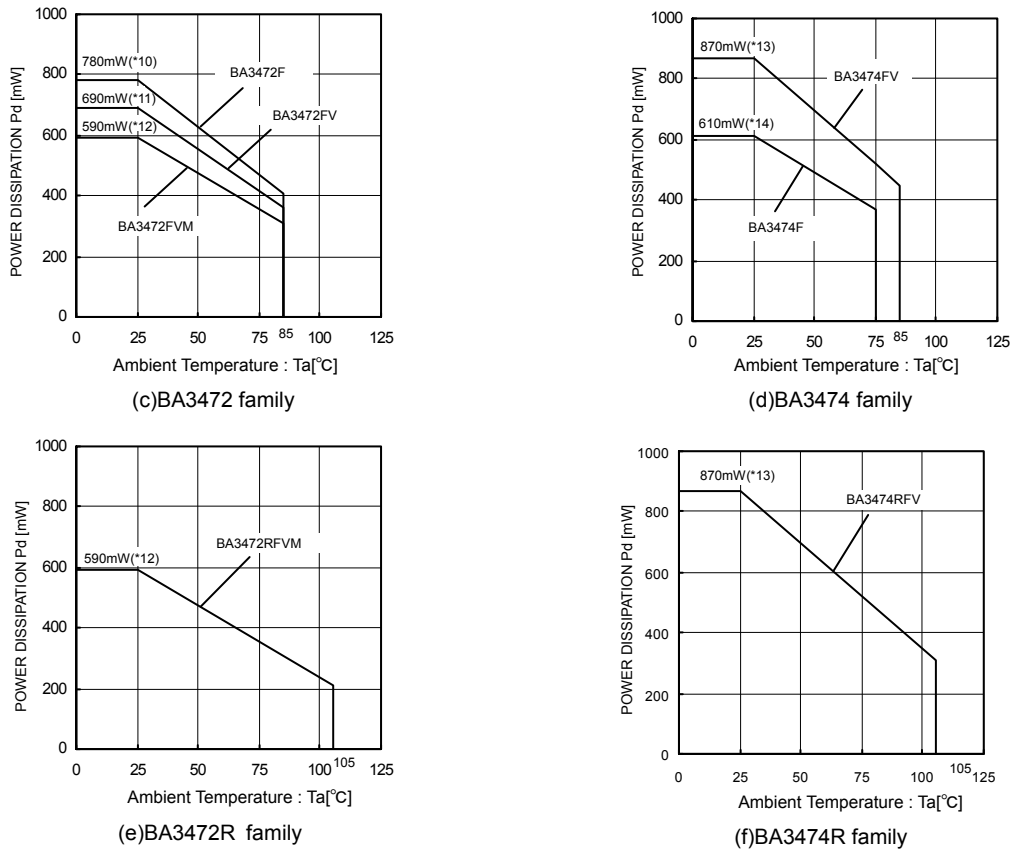

Fig. 99 Thermal resistance and derating curve



(*10)	(*11)	(*12)	(*13)	(*14)	Unit
6.2	5.5	4.7	7.0	4.9	[mW/°C]

When using the unit above Ta=25[°C], subtract the value above per degree[°C].
Permissible dissipation is the value when FR4 glass epoxy board 70[mm]×70[mm]×1.6[mm](cooper foil area below 3[%]) is mounted.

Fig. 100 Derating curve

●Description of Electrical Characteristics

Described below are descriptions of the relevant electrical terms

Please note that item names, symbols and their meanings may differ from those on another manufacturer's documents.

1. Absolute maximum ratings

The absolute maximum ratings are values that should never be exceeded, since doing so may result in deterioration of electrical characteristics or damage to the part itself as well as peripheral components.

1.1 Power supply voltage (VCC-VEE)

Expresses the maximum voltage that can be supplied between the positive and negative supply terminals without causing deterioration of the electrical characteristics or destruction of the internal circuitry.

1.2 Differential input voltage (V_{id})

Indicates the maximum voltage that can be supplied between the non-inverting and inverting terminals without damaging the IC.

1.3 Input common-mode voltage range (V_{icm})

Signifies the maximum voltage that can be supplied to non-inverting and inverting terminals without causing deterioration of the characteristics or damage to the IC itself. Normal operation is not guaranteed within the common-mode voltage range of the maximum ratings – use within the input common-mode voltage range of the electric characteristics instead.

1.4 Power dissipation (P_d)

Indicates the power that can be consumed by a particular mounted board at ambient temperature (25°C). For packaged products, P_d is determined by the maximum junction temperature and the thermal resistance.

2. Electrical characteristics**2.1 Input offset voltage (V_{io})**

Signifies the voltage difference between the non-inverting and inverting terminals. It can be thought of as the input voltage difference required for setting the output voltage to 0 V.

2.2 Input offset current (I_{io})

Indicates the difference of input bias current between the non-inverting and inverting terminals.

2.3 Input bias current (I_b)

Denotes the current that flows into or out of the input terminal, it is defined by the average of the input bias current at the non-inverting terminal and the input bias current at the inverting terminal.

2.4 Circuit current (I_{CC})

Indicates the current of the IC itself that flows under specified conditions and during no-load steady state.

2.5 maximum output voltage (V_{OM})

Indicates the voltage range that can be output by the IC under specified load condition. It is typically divided into high-level output voltage and low-level output voltage.

2.6 Large signal voltage gain (A_V)

The amplifying rate (gain) of the output voltage against the voltage difference between non-inverting and inverting terminals, it is (normally) the amplifying rate (gain) with respect to DC voltage.

$$A_V = (\text{output voltage fluctuation}) / (\text{input offset fluctuation})$$

2.7 Input common-mode voltage range (V_{icm})

Indicates the input voltage range under which the IC operates normally.

2.8 Common-mode rejection ratio (CMRR)

Signifies the ratio of fluctuation of the input offset voltage when the in-phase input voltage is changed (DC fluctuation).

$$CMRR = (\text{change in input common-mode voltage}) / (\text{input offset fluctuation})$$

2.9 Power supply rejection ratio (PSRR)

Denotes the ratio of fluctuation of the input offset voltage when supply voltage is changed (DC fluctuation).

$$PSRR = (\text{change in power supply voltage}) / (\text{input offset fluctuation})$$

2.10 Channel separation (CS)

Expresses the amount of fluctuation of the input offset voltage or output voltage with respect to the change in the output voltage of a driven channel.

2.11 Slew rate (SR)

Indicates the time fluctuation ratio of the output voltage when an input step signal is supplied.

2.12 Maximum frequency (f_t)

Indicates a frequency where the voltage gain of Op-Amp is 1.

2.13 Total harmonic distortion + Noise (THD+N)

Indicates the fluctuation of input offset voltage or that of output voltage with reference to the change of output voltage of driven channel.

2.14 Input referred noise voltage (V_n)

Indicates a noise voltage generated inside the operational amplifier equivalent by ideal voltage source connected in series with input terminal.

●Ordering part number

B	A
---	---

Part No.

3	4	7	2
---	---	---	---

Part No.

- 3472 • 3472R
- 3474 • 3474R

F	V
---	---

Package

- F : SOP8
SOP14
- FV : SSOP-B8
SSOP-B14
- FVM : MSOP8

E	2
---	---

Packaging and forming specification

- E2: Embossed tape and reel
(SOP8/SOP14/SSOP-B8/SSOP-B14)
- TR: Embossed tape and reel
(MSOP8)

SOP8

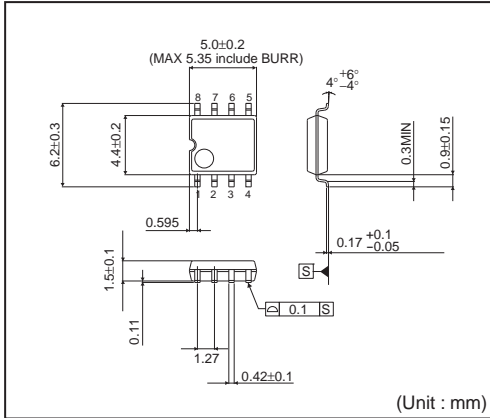

<Tape and Reel information>

Tape	Embossed carrier tape
Quantity	2500pcs
Direction of feed	E2 (The direction is the 1pin of product is at the upper left when you hold reel on the left hand and you pull out the tape on the right hand)

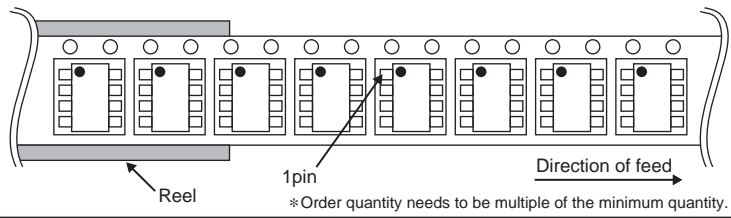

SOP14

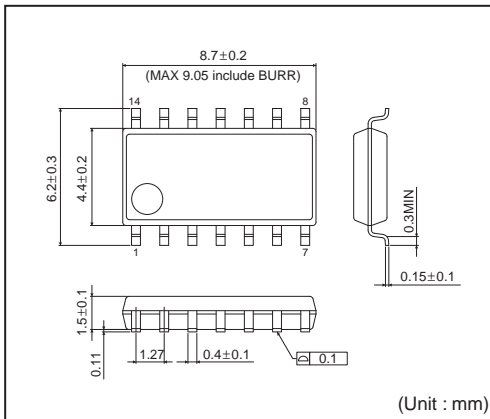

<Tape and Reel information>

Tape	Embossed carrier tape
Quantity	2500pcs
Direction of feed	E2 (The direction is the 1pin of product is at the upper left when you hold reel on the left hand and you pull out the tape on the right hand)

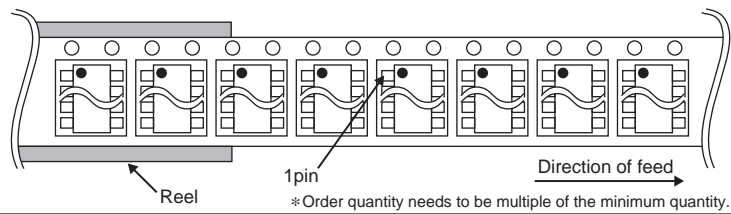

SSOP-B8

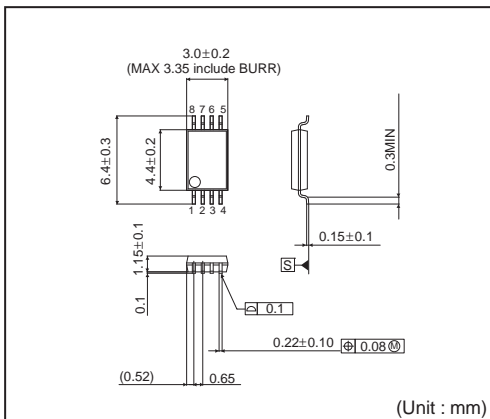

<Tape and Reel information>

Tape	Embossed carrier tape
Quantity	2500pcs
Direction of feed	E2 (The direction is the 1pin of product is at the upper left when you hold reel on the left hand and you pull out the tape on the right hand)

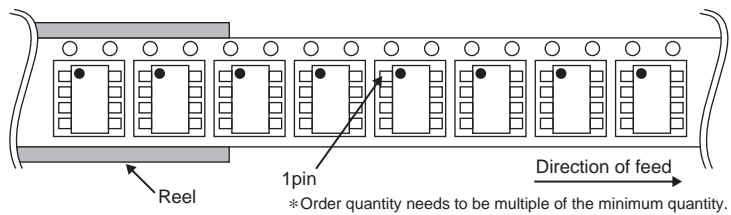

SSOP-B14

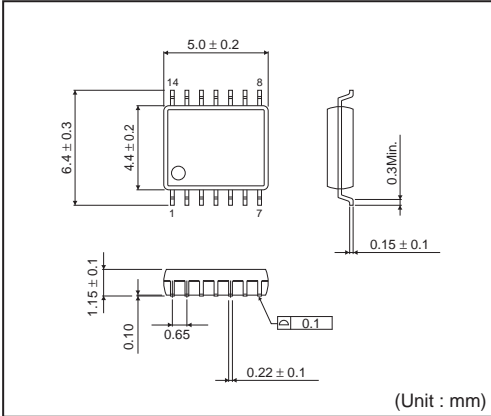

<Tape and Reel information>

Tape	Embossed carrier tape
Quantity	2500pcs
Direction of feed	E2 (The direction is the 1pin of product is at the upper left when you hold reel on the left hand and you pull out the tape on the right hand)

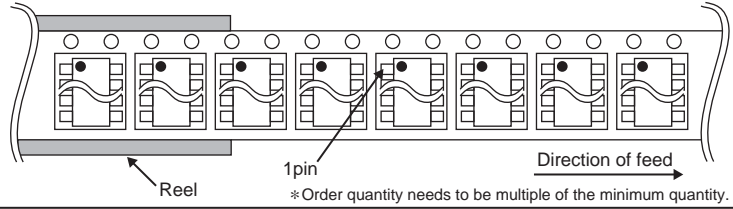

MSOP8

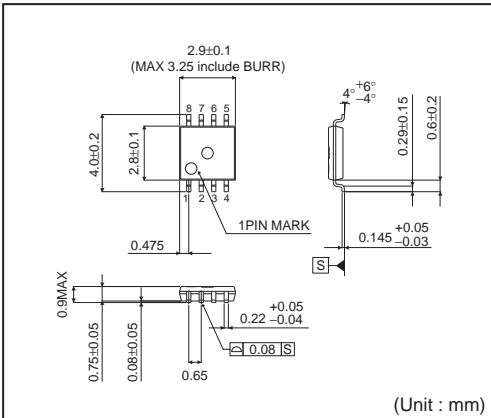

<Tape and Reel information>

Tape	Embossed carrier tape
Quantity	3000pcs
Direction of feed	TR (The direction is the 1pin of product is at the upper right when you hold reel on the left hand and you pull out the tape on the right hand)

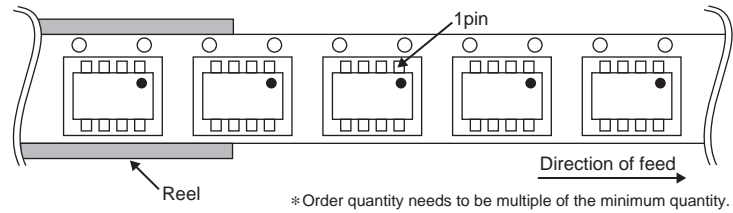

Notes

No copying or reproduction of this document, in part or in whole, is permitted without the consent of ROHM Co.,Ltd.

The content specified herein is subject to change for improvement without notice.

The content specified herein is for the purpose of introducing ROHM's products (hereinafter "Products"). If you wish to use any such Product, please be sure to refer to the specifications, which can be obtained from ROHM upon request.

Examples of application circuits, circuit constants and any other information contained herein illustrate the standard usage and operations of the Products. The peripheral conditions must be taken into account when designing circuits for mass production.

Great care was taken in ensuring the accuracy of the information specified in this document. However, should you incur any damage arising from any inaccuracy or misprint of such information, ROHM shall bear no responsibility for such damage.

The technical information specified herein is intended only to show the typical functions of and examples of application circuits for the Products. ROHM does not grant you, explicitly or implicitly, any license to use or exercise intellectual property or other rights held by ROHM and other parties. ROHM shall bear no responsibility whatsoever for any dispute arising from the use of such technical information.

The Products specified in this document are intended to be used with general-use electronic equipment or devices (such as audio visual equipment, office-automation equipment, communication devices, electronic appliances and amusement devices).

The Products specified in this document are not designed to be radiation tolerant.

While ROHM always makes efforts to enhance the quality and reliability of its Products, a Product may fail or malfunction for a variety of reasons.

Please be sure to implement in your equipment using the Products safety measures to guard against the possibility of physical injury, fire or any other damage caused in the event of the failure of any Product, such as derating, redundancy, fire control and fail-safe designs. ROHM shall bear no responsibility whatsoever for your use of any Product outside of the prescribed scope or not in accordance with the instruction manual.

The Products are not designed or manufactured to be used with any equipment, device or system which requires an extremely high level of reliability the failure or malfunction of which may result in a direct threat to human life or create a risk of human injury (such as a medical instrument, transportation equipment, aerospace machinery, nuclear-reactor controller, fuel-controller or other safety device). ROHM shall bear no responsibility in any way for use of any of the Products for the above special purposes. If a Product is intended to be used for any such special purpose, please contact a ROHM sales representative before purchasing.

If you intend to export or ship overseas any Product or technology specified herein that may be controlled under the Foreign Exchange and the Foreign Trade Law, you will be required to obtain a license or permit under the Law.



Thank you for your accessing to ROHM product informations.
More detail product informations and catalogs are available, please contact us.

ROHM Customer Support System

<http://www.rohm.com/contact/>