

< Silicon RF Power MOS FET (Discrete) >

RD01MUS2

RoHS Compliance, Silicon MOSFET Power Transistor 520MHz,1W

DESCRIPTION

RD01MUS2 is a MOS FET type transistor specifically designed for VHF/UHF RF amplifiers applications. This device has an internal monolithic zener diode from gate to source for ESD protection.

FEATURES

- High power gain:
Pout>0.8W, Gp>14dB @Vdd=7.2V,f=520MHz
- High Efficiency: 65%typ.
- Integrated gate protection diode

APPLICATION

For output stage of high power amplifiers in VHF/UHF Band mobile radio sets.

RoHS COMPLIANT

RD01MUS2-101,T113 is a RoHS compliant products.

This product includes the lead in high melting temperature type solders.

However, it is applicable to the following exceptions of RoHS Directions.

- 1.Lead in high melting temperature type solders (i.e.tin-lead solder alloys containing more than85% lead.)

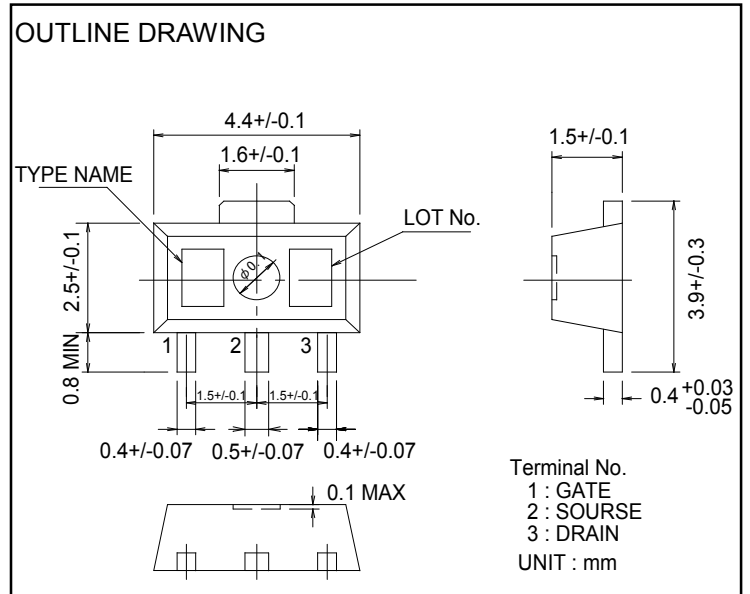

ABSOLUTE MAXIMUM RATINGS (Tc=25°C UNLESS OTHERWISE NOTED)

SYMBOL	PARAMETER	CONDITIONS	RATINGS	UNIT
VDSS	Drain to source voltage	Vgs=0V	30	V
VGSS	Gate to source voltage	Vds=0V	-5/+10	V
Pch	Channel dissipation	Tc=25°C	3.6	W
Pin	Input Power	Zg=Zl=50Ω	100	mW
ID	Drain Current	-	600	mA
Tch	Channel Temperature	-	150	°C
Tstg	Storage temperature	-	-40 to +125	°C
Rth j-c	Thermal resistance	Junction to case	34.5	°C/W

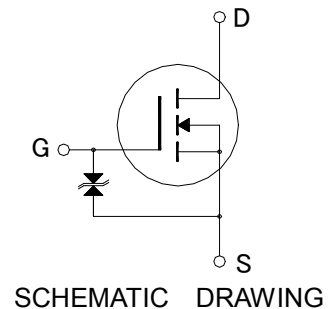

Note: Above parameters are guaranteed independently.

ELECTRICAL CHARACTERISTICS (Tc=25°C, UNLESS OTHERWISE NOTED)

SYMBOL	PARAMETER	CONDITIONS	LIMITS			UNIT
			MIN	TYP	MAX	
IDSS	Zero gate voltage drain current	VDS=17V, VGS=0V	-	-	50	uA
IGSS	Gate to source leak current	VGS=10V, VDS=0V	-	-	1	uA
Vth	Gate threshold Voltage	VDS=12V, IDS=1mA	1.3	1.8	2.3	V
Pout	Output power	VDD=7.2V, Pin=30mW	0.8	1.4	-	W
ηd	Drain efficiency	f=520MHz, Idq=100mA	50	65	-	%

Note: Above parameters, ratings, limits and conditions are subject to change.

RD01MUS2

RoHS Compliance, Silicon MOSFET Power Transistor 520MHz,1W

TYPICAL CHARACTERISTICS

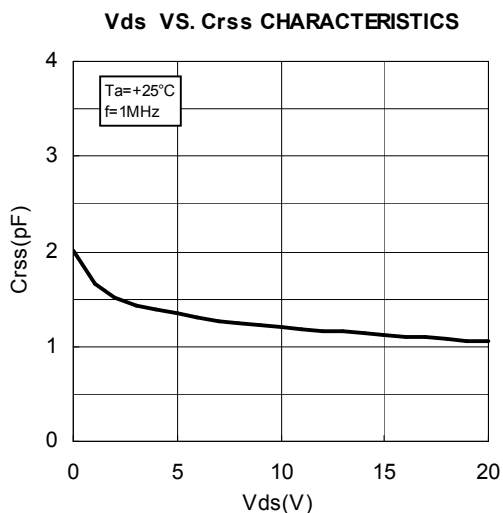
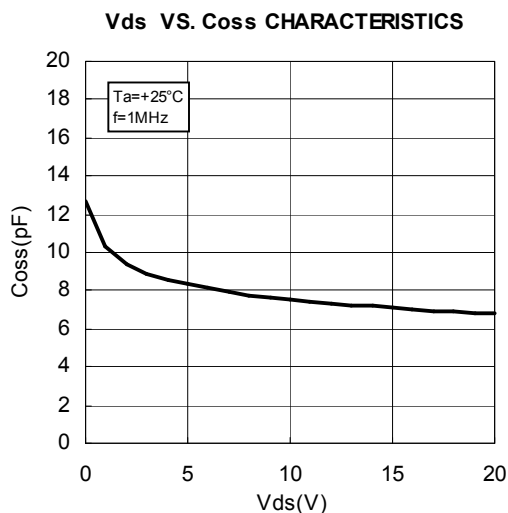
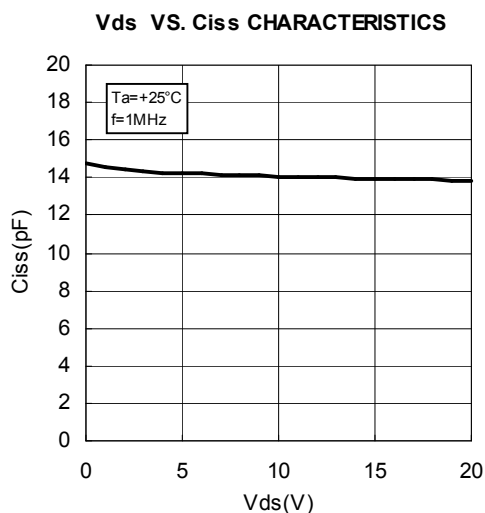
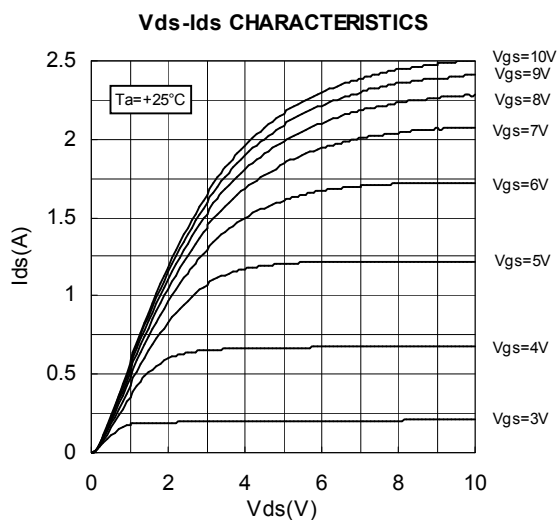
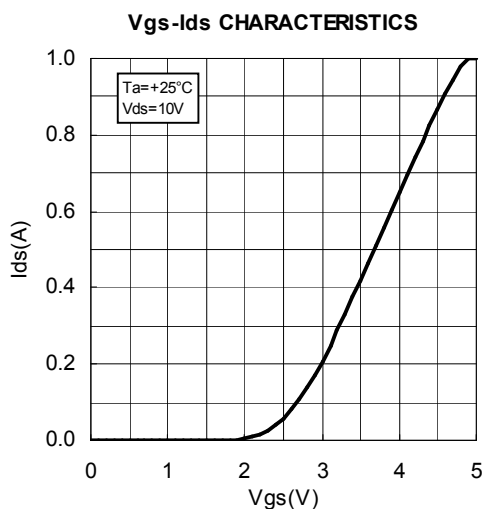
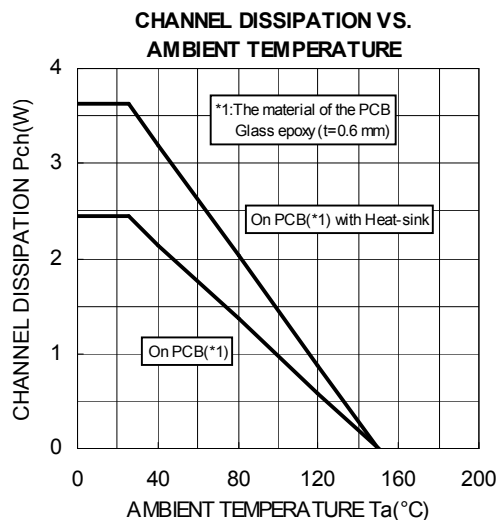

RD01MUS2

RoHS Compliance, Silicon MOSFET Power Transistor 520MHz,1W

TYPICAL CHARACTERISTICS

Pin-Po CHARACTERISTICS

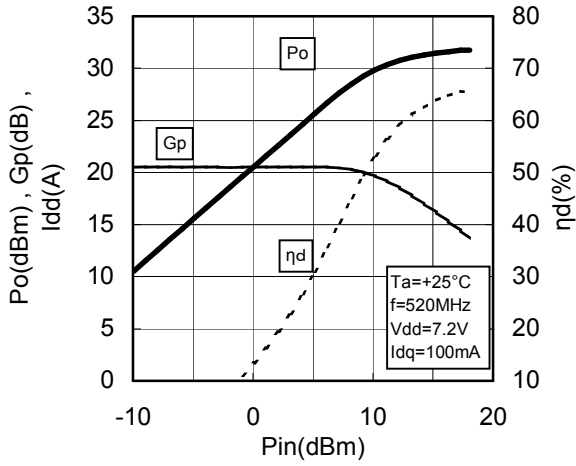

Pin-Po CHARACTERISTICS

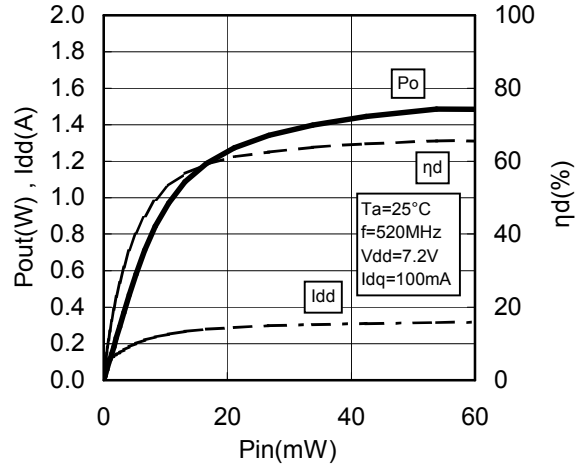

Vdd-Po CHARACTERISTICS

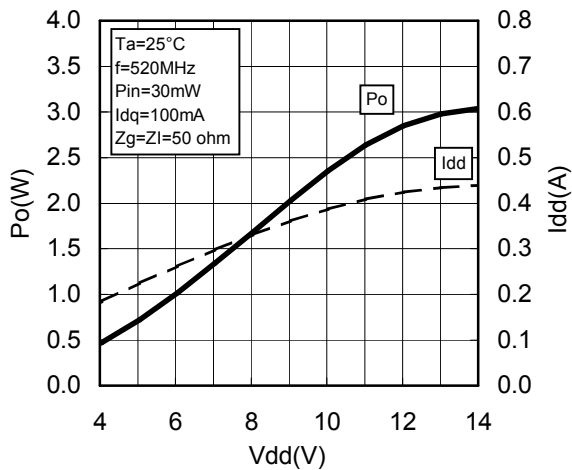

Vgs-Ids CHARACTERISTICS 2

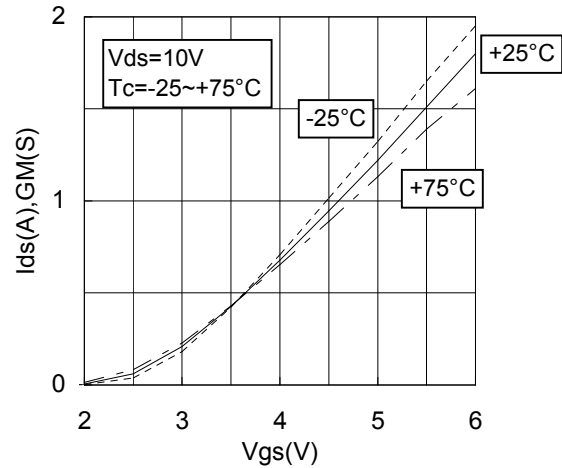

RD01MUS2

RoHS Compliance, Silicon MOSFET Power Transistor 520MHz,1W

TEST CIRCUIT(f=520MHz)

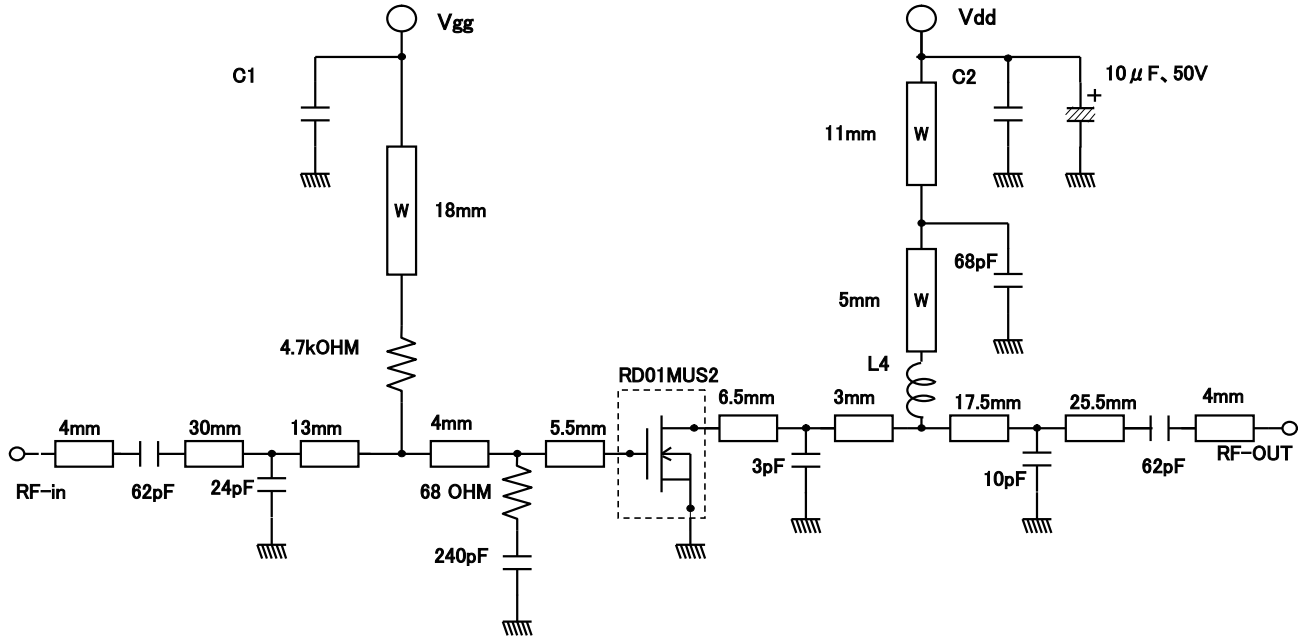

L1: Enameled wire 5 Turns, D: 0.43mm, 2.46mm O.D

C1, C2: 1000pF, 0.022 µF in parallel

Note: Board material Glass epoxy substrate
Micro strip line width=1.0mm, 50 OHM, er:4.8, t=0.6mm

INPUT/OUTPUT IMPEDANCE VS. FREQUENCY CHARACTERISTICS

520MHz Z_{in}^* Z_{out}^*
 $Z_0=50\Omega$

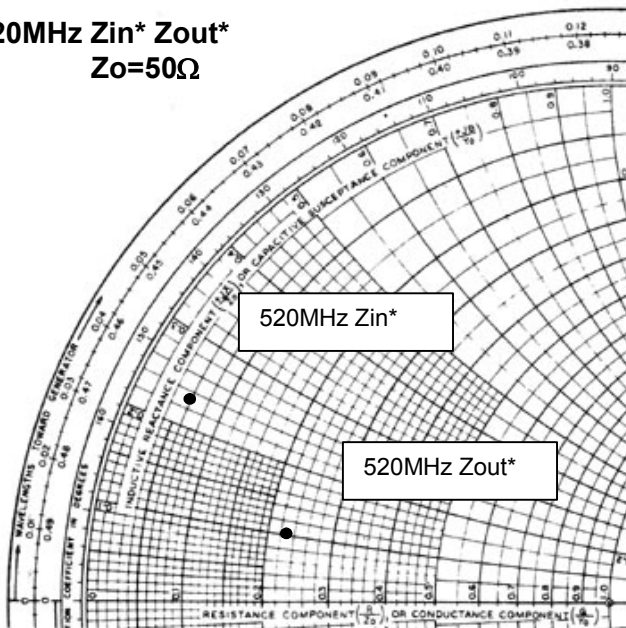

Vdd=7.2V, Idq=100mA(Vgg adj.), Pin=0.03W

$Z_{in}^* = 3.11 + j11.56$
 $Z_{out}^* = 11.64 + j4.74$

Z_{in}^* : Complex conjugate of input impedance
 Z_{out}^* : Complex conjugate of output impedance

RD01MUS2

RoHS Compliance, Silicon MOSFET Power Transistor 520MHz,1W

RD01MSU2 S-PARAMETER DATA (@Vdd=7.2V, Id=100mA)

Freq. [MHz]	S11		S21		S12		S22	
	(mag)	(ang)	(mag)	(ang)	(mag)	(ang)	(mag)	(ang)
100	0.941	-83.9	18.598	128.5	0.046	36.0	0.761	-65.2
150	0.881	-107.9	14.425	112.0	0.052	21.1	0.660	-85.2
175	0.863	-116.7	12.863	105.7	0.054	15.3	0.632	-92.3
200	0.844	-123.9	11.496	100.2	0.054	10.8	0.606	-98.0
250	0.820	-134.4	9.351	91.4	0.054	3.0	0.575	-107.2
300	0.813	-142.3	7.854	84.1	0.053	-4.3	0.566	-114.1
350	0.807	-148.3	6.682	77.7	0.053	-7.8	0.569	-119.4
400	0.807	-152.7	5.797	72.5	0.051	-12.7	0.574	-123.7
450	0.809	-156.9	5.096	67.0	0.048	-17.1	0.588	-127.7
500	0.810	-160.0	4.487	62.7	0.047	-20.0	0.604	-131.0
520	0.812	-161.2	4.286	61.0	0.046	-21.0	0.609	-132.4
550	0.813	-163.1	3.996	58.1	0.045	-24.7	0.620	-134.3
600	0.820	-165.6	3.595	54.1	0.041	-25.0	0.637	-137.2
650	0.822	-168.0	3.231	50.4	0.040	-29.2	0.653	-139.7
700	0.831	-170.1	2.944	46.8	0.038	-31.4	0.672	-142.4
750	0.837	-172.1	2.686	43.2	0.035	-33.6	0.686	-144.6
800	0.842	-174.0	2.451	40.0	0.033	-35.2	0.703	-147.1
850	0.847	-176.0	2.255	36.6	0.030	-37.7	0.717	-149.3
900	0.853	-177.9	2.076	33.6	0.027	-37.8	0.731	-151.3
950	0.857	-179.6	1.915	30.7	0.025	-37.4	0.742	-153.6
1000	0.862	-178.9	1.769	28.0	0.022	-37.8	0.757	-155.5
1050	0.865	-177.2	1.645	25.5	0.020	-37.5	0.766	-157.6
1100	0.870	-175.6	1.526	23.2	0.017	-34.9	0.778	-159.3

RD01MSU2 S-PARAMETER DATA (@Vdd=12.5V, Id=100mA)

Freq. [MHz]	S11		S21		S12		S22	
	(mag)	(ang)	(mag)	(ang)	(mag)	(ang)	(mag)	(ang)
100	0.957	-79.3	18.576	131.4	0.041	40.9	0.740	-59.4
150	0.902	-103.4	14.762	114.9	0.049	24.5	0.642	-78.6
175	0.884	-112.7	13.236	108.3	0.049	17.9	0.615	-85.4
200	0.867	-120.1	11.888	102.6	0.051	13.0	0.592	-91.3
250	0.843	-131.4	9.751	93.5	0.051	6.1	0.559	-100.5
300	0.831	-139.8	8.210	86.0	0.050	-1.5	0.553	-107.6
350	0.824	-146.1	7.005	79.5	0.050	-6.4	0.553	-112.9
400	0.821	-150.9	6.079	74.1	0.048	-11.2	0.559	-117.9
450	0.823	-155.3	5.343	68.6	0.046	-14.5	0.573	-122.0
500	0.824	-158.6	4.726	64.2	0.043	-19.2	0.589	-125.5
520	0.826	-160.0	4.523	62.2	0.044	-19.3	0.594	-127.1
550	0.825	-161.9	4.226	59.6	0.042	-21.9	0.605	-129.0
600	0.829	-164.4	3.792	55.6	0.040	-23.9	0.622	-132.0
650	0.833	-167.2	3.429	51.5	0.037	-27.8	0.639	-134.9
700	0.839	-169.4	3.117	47.7	0.035	-30.5	0.656	-137.8
750	0.843	-171.5	2.837	44.2	0.033	-31.2	0.675	-140.1
800	0.849	-173.6	2.597	41.1	0.030	-34.9	0.691	-143.0
850	0.854	-175.4	2.397	37.6	0.028	-35.3	0.705	-145.2
900	0.858	-177.2	2.196	34.7	0.026	-35.7	0.718	-147.6
950	0.862	-179.0	2.034	31.8	0.022	-37.5	0.732	-149.6
1000	0.869	-179.4	1.890	29.0	0.020	-37.4	0.745	-151.9
1050	0.870	-177.6	1.745	26.2	0.018	-37.7	0.757	-154.1
1100	0.876	-175.9	1.625	23.4	0.017	-33.9	0.770	-156.0

RD01MUS2

RoHS Compliance, Silicon MOSFET Power Transistor 520MHz,1W

ATTENTION:

- 1.High Temperature ; This product might have a heat generation while operation,Please take notice that have a possibility to receive a burn to touch the operating product directly or touch the product until cold after switch off. At the near the product,do not place the combustible material that have possibilities to arise the fire.
- 2.Generation of High Frequency Power ; This product generate a high frequency power. Please take notice that do not leakage the unnecessary electric wave and use this products without cause damage for human and property per normal operation.
- 3.Before use; Before use the product,Please design the equipment in consideration of the risk for human and electric wave obstacle for equipment.

PRECAUTIONS FOR THE USE OF MITSUBISHI SILICON RF POWER DEVICES:

1. The specifications of mention are not guarantee values in this data sheet. Please confirm additional details regarding operation of these products from the formal specification sheet. For copies of the formal specification sheets, please contact one of our sales offices.
- 2.RA series products (RF power amplifier modules) and RD series products (RF power transistors) are designed for consumer mobile communication terminals and were not specifically designed for use in other applications. In particular, while these products are highly reliable for their designed purpose, they are not manufactured under a quality assurance testing protocol that is sufficient to guarantee the level of reliability typically deemed necessary for critical communications elements and In the application, which is base station applications and fixed station applications that operate with long term continuous transmission and a higher on-off frequency during transmitting, please consider the derating, the redundancy system, appropriate setting of the maintain period and others as needed. For the reliability report which is described about predicted operating life time of Mitsubishi Silicon RF Products , please contact Mitsubishi Electric Corporation or an authorized Mitsubishi Semiconductor product distributor.
3. RD series products use MOSFET semiconductor technology. They are sensitive to ESD voltage therefore appropriate ESD precautions are required.
4. In the case of use in below than recommended frequency, there is possibility to occur that the device is deteriorated or destroyed due to the RF-swing exceed the breakdown voltage.
5. In order to maximize reliability of the equipment, it is better to keep the devices temperature low. It is recommended to utilize a sufficient sized heat-sink in conjunction with other cooling methods as needed (fan, etc.) to keep the channel temperature for RD series products lower than 120deg/C(in case of Tchmax=150deg/C) ,140deg/C(in case of Tchmax=175deg/C) under standard conditions.
6. Do not use the device at the exceeded the maximum rating condition. In case of plastic molded devices, the exceeded maximum rating condition may cause blowout, smoldering or catch fire of the molding resin due to extreme short current flow between the drain and the source of the device. These results causes in fire or injury.
7. For specific precautions regarding assembly of these products into the equipment, please refer to the supplementary items in the specification sheet.
8. Warranty for the product is void if the products protective cap (lid) is removed or if the product is modified in any way from it's original form.
9. For additional "Safety first" in your circuit design and notes regarding the materials, please refer the last page of this data sheet.
10. Please refer to the additional precautions in the formal specification sheet.

RD01MUS2

RoHS Compliance, Silicon MOSFET Power Transistor 520MHz,1W

Keep safety first in your circuit designs!

Mitsubishi Electric Corporation puts the maximum effort into making semiconductor products better and more reliable, but there is always the possibility that trouble may occur with them. Trouble with semiconductors may lead to personal injury, fire or property damage. Remember to give due consideration to safety when making your circuit designs, with appropriate measures such as (i) placement of substitutive, auxiliary circuits, (ii) use of non-flammable material or (iii) prevention against any malfunction or mishap.

Notes regarding these materials

- These materials are intended as a reference to assist our customers in the selection of the Mitsubishi semiconductor product best suited to the customer's application; they do not convey any license under any intellectual property rights, or any other rights, belonging to Mitsubishi Electric Corporation or a third party.
- Mitsubishi Electric Corporation assumes no responsibility for any damage, or infringement of any third-party's rights, originating in the use of any product data, diagrams, charts, programs, algorithms, or circuit application examples contained in these materials.
- All information contained in these materials, including product data, diagrams, charts, programs and algorithms represents information on products at the time of publication of these materials, and are subject to change by Mitsubishi Electric Corporation without notice due to product improvements or other reasons. It is therefore recommended that customers contact Mitsubishi Electric Corporation or an authorized Mitsubishi Semiconductor product distributor for the latest product information before purchasing a product listed herein.
The information described here may contain technical inaccuracies or typographical errors. Mitsubishi Electric Corporation assumes no responsibility for any damage, liability, or other loss rising from these inaccuracies or errors.
Please also pay attention to information published by Mitsubishi Electric Corporation by various means, including the Mitsubishi Semiconductor home page (<http://www.MitsubishiElectric.com/>).
- When using any or all of the information contained in these materials, including product data, diagrams, charts, programs, and algorithms, please be sure to evaluate all information as a total system before making a final decision on the applicability of the information and products. Mitsubishi Electric Corporation assumes no responsibility for any damage, liability or other loss resulting from the information contained herein.
- Mitsubishi Electric Corporation semiconductors are not designed or manufactured for use in a device or system that is used under circumstances in which human life is potentially at stake. Please contact Mitsubishi Electric Corporation or an authorized Mitsubishi Semiconductor product distributor when considering the use of a product contained herein for any specific purposes, such as apparatus or systems for transportation, vehicular, medical, aerospace, nuclear, or undersea repeater use.
- The prior written approval of Mitsubishi Electric Corporation is necessary to reprint or reproduce in whole or in part these materials.
- If these products or technologies are subject to the Japanese export control restrictions, they must be exported under a license from the Japanese government and cannot be imported into a country other than the approved destination.
Any diversion or re-export contrary to the export control laws and regulations of Japan and/or the country of destination is prohibited.
- Please contact Mitsubishi Electric Corporation or an authorized Mitsubishi Semiconductor product distributor for further details on these materials or the products contained therein.