



## HIGH IP3 GaAs MMIC MIXER with INTEGRATED LO AMPLIFIER, 400 - 650 MHz

### Typical Applications

The HMC585MS8G / HMC585MS8GE are ideal for:

- Basestations & Repeaters
- GSM, GPRS & EDGE
- CDMA & W-CDMA
- Cable Modem Termination Systems

### Features

- High Input IP3: +33 dBm
- Conversion Loss: 9 dB
- Low LO Drive: -2 to +4 dBm
- Single Supply: +5V @ 50 mA
- Compact MSOP Package: 14.8mm<sup>2</sup>

### Functional Diagram

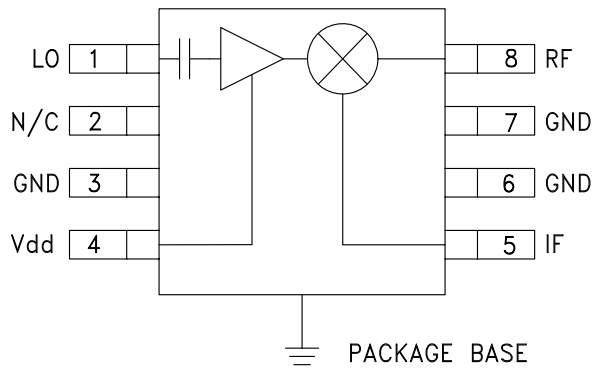

### General Description

The HMC585MS8G & HMC585MS8GE are high dynamic range passive MMIC mixers with integrated LO amplifiers in plastic surface mount 8 lead Mini Small Outline Packages (MSOP) covering an RF range of 400 MHz to 650 MHz. The LO range of 300 MHz to 750 MHz supports both high side and low side LO applications. Excellent input IP3 performance of +33 dBm for down conversion and +27 dBm for up conversion is provided for 2.5G & 3G applications at an LO drive of 0 dBm. RF conversion loss is 9 dB typical. The DC to 250 MHz IF frequency response will satisfy a wide range of Tx and Rx frequency plans.

### Electrical Specifications, $T_A = +25^\circ\text{C}$ , LO = 0 dBm, IF = 50 MHz\*, Vdd = 5V

Parameter	Min.	Typ.	Max.	Units
Frequency Range, RF		400 - 650		MHz
Frequency Range, LO		300 - 750		MHz
Frequency Range, IF		DC - 0.25		GHz
Conversion Loss		9.0	11	dB
LO to RF Isolation		7		dB
LO to IF Isolation	10	15		dB
IP3 (Input)	30	33		dBm
1 dB Gain Compression (Input)		22		dBm
LO Input Drive Level (Typical)		-2 to +4		dBm
Supply Current		50		mA

\*Unless otherwise noted, all measurements performed as a downconverter, with high side LO & IF = 50 MHz.

**Conversion Gain vs. Temperature @ LO = 0 dBm**

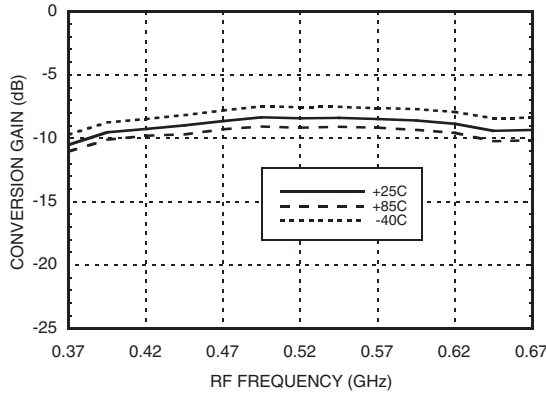

**Isolation @ LO = 0 dBm**

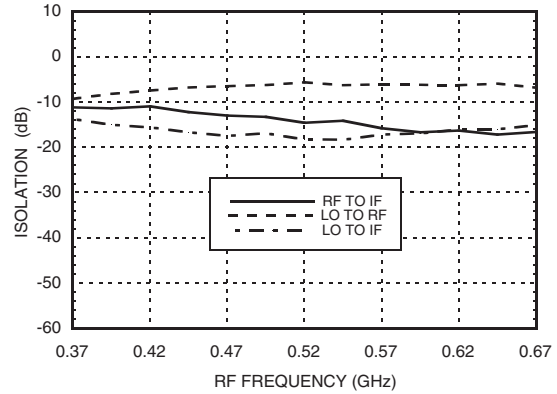

**Conversion Gain vs. LO Drive**

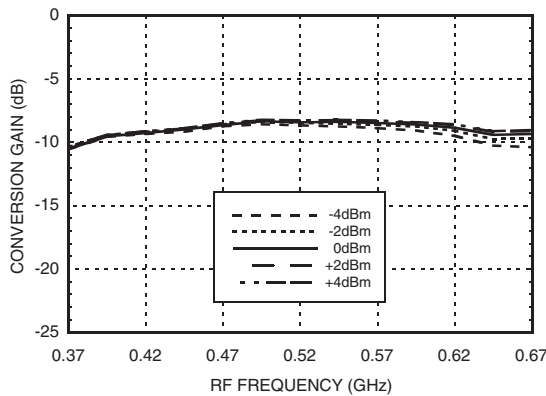

**Return Loss @ LO = 0 dBm**

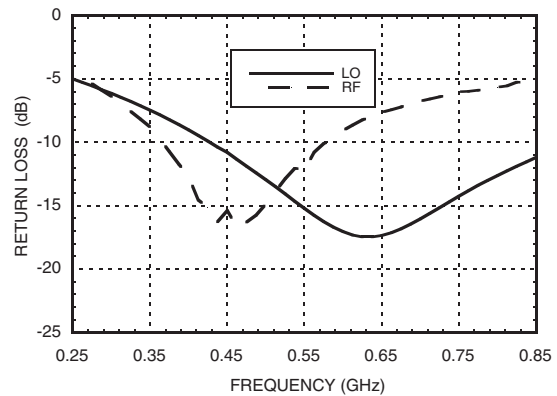

**Upconverter Performance Conversion Gain @ LO = 0 dBm**

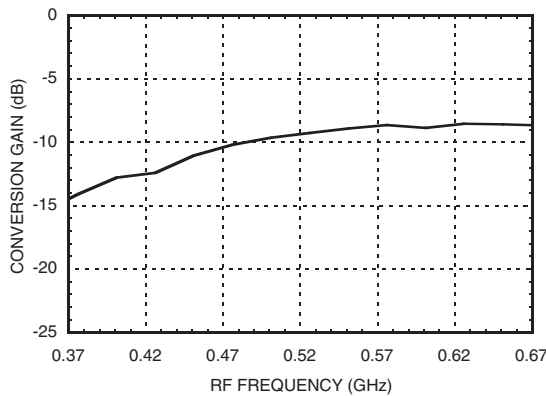

**IF Bandwidth @ LO = 0 dBm**

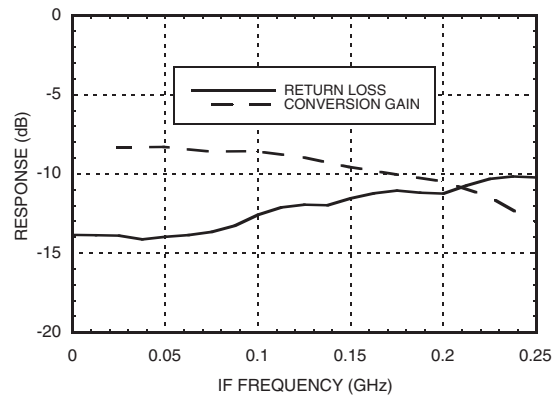

Unless otherwise noted, all measurements performed as a downconverter, with high side LO & IF = 50 MHz.

For price, delivery, and to place orders, please contact Hittite Microwave Corporation:  
 20 Alpha Road, Chelmsford, MA 01824 Phone: 978-250-3343 Fax: 978-250-3373  
 Order On-line at [www.hittite.com](http://www.hittite.com)

## HIGH IP3 GaAs MMIC MIXER with INTEGRATED LO AMPLIFIER, 400 - 650 MHz



**Input IP3 vs. Temperature @ LO= 0 dBm**

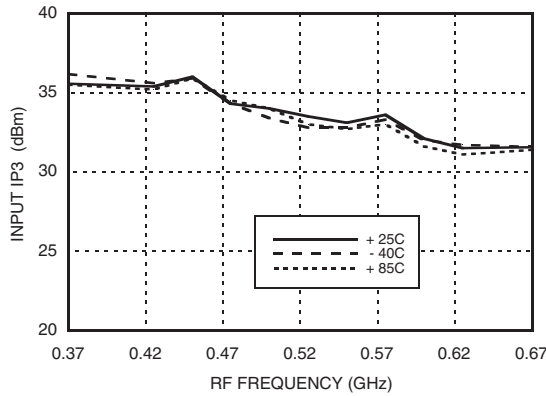

**Input IP3 vs. LO Drive**

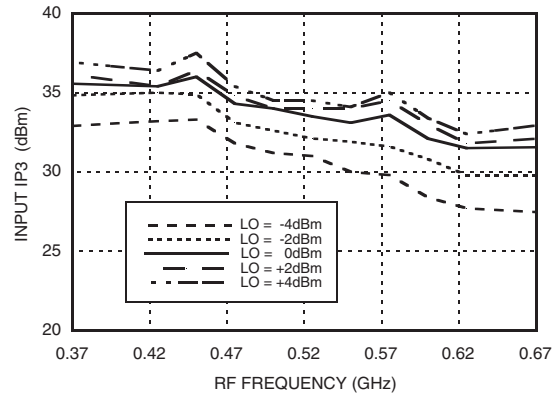

**Input IP2 vs. Temperature @ LO= 0 dBm**

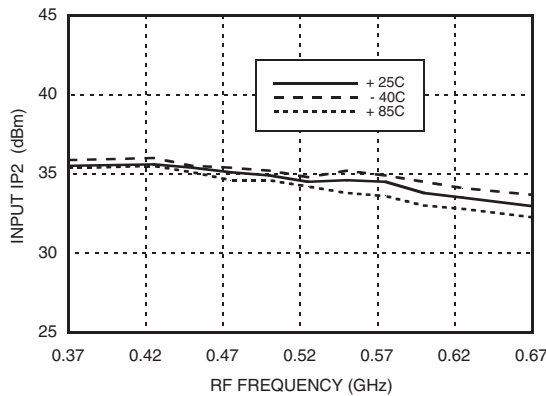

**Input IP2 vs. LO Drive**

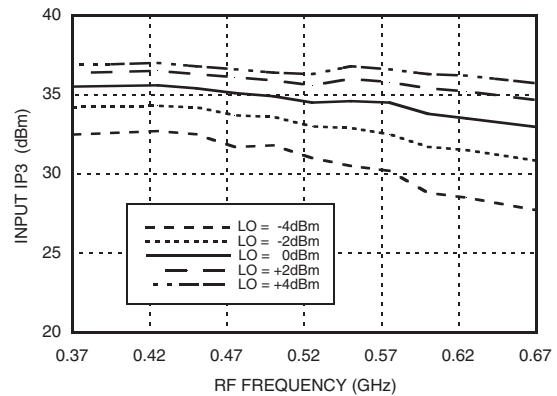

**Input P1dB vs. Temperature @ LO= 0 dBm**

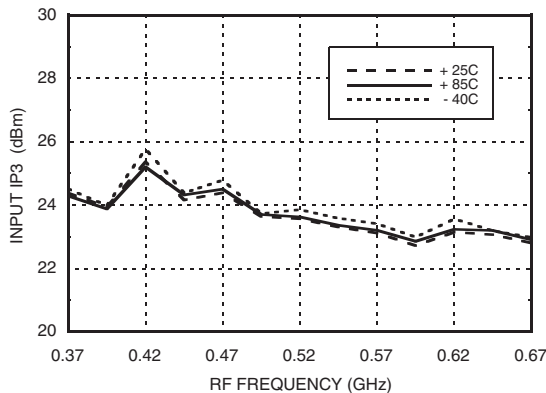

**Upconverter IP3 vs. LO Drive, IF= 50 MHz**

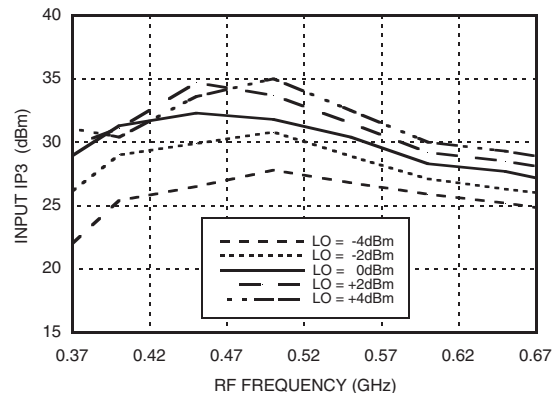

Unless otherwise noted, all measurements performed as a downconverter, with high side LO & IF = 50 MHz.

For price, delivery, and to place orders, please contact Hittite Microwave Corporation:  
 20 Alpha Road, Chelmsford, MA 01824 Phone: 978-250-3343 Fax: 978-250-3373  
 Order On-line at [www.hittite.com](http://www.hittite.com)



## HIGH IP3 GaAs MMIC MIXER with INTEGRATED LO AMPLIFIER, 400 - 650 MHz

**Input IP3 vs. LO Drive, IF= 100 MHz**

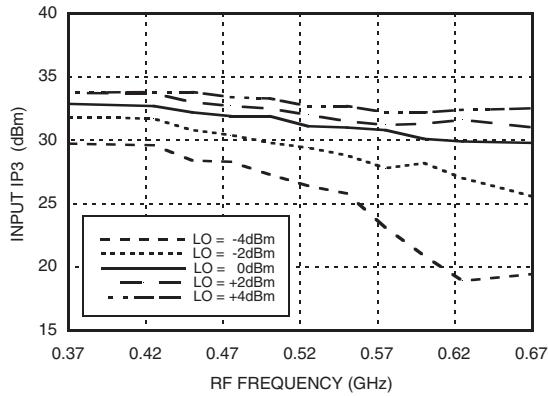

**Input IP3 vs. LO Drive, IF= 150 MHz**

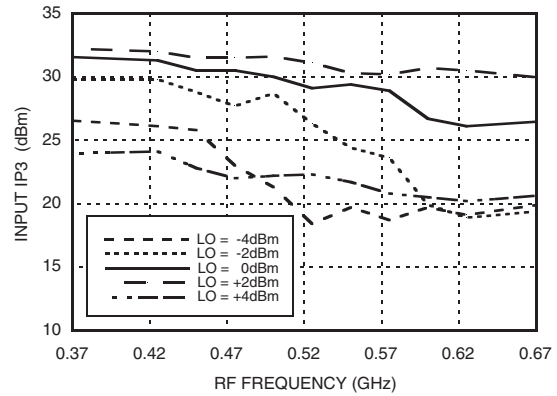

**Input IP3 vs. LO Drive, IF= 200 MHz**

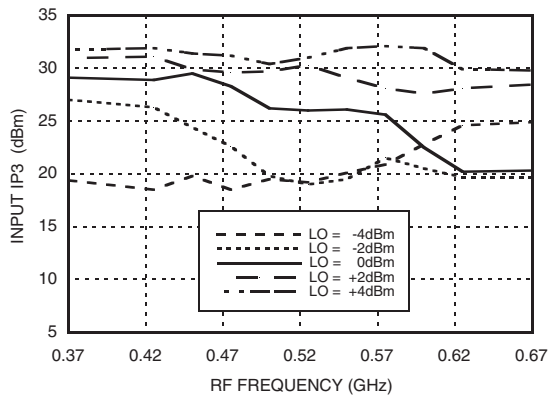

**Conversion Gain vs. LO Drive, IF= 200 MHz**

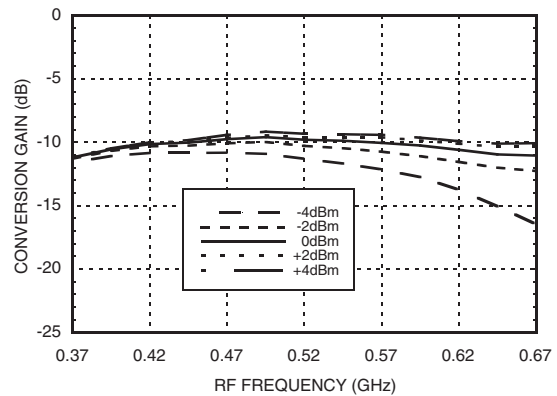

Unless otherwise noted, all measurements performed as a downconverter, with high side LO & IF = 50 MHz.

For price, delivery, and to place orders, please contact Hittite Microwave Corporation:  
 20 Alpha Road, Chelmsford, MA 01824 Phone: 978-250-3343 Fax: 978-250-3373  
 Order On-line at [www.hittite.com](http://www.hittite.com)



MICROWAVE CORPORATION v01.0907



# HMC585MS8G / 585MS8GE

## HIGH IP3 GaAs MMIC MIXER with INTEGRATED LO AMPLIFIER, 400 - 650 MHz

### MxN Spurious Outputs

mRF	nLO				
	0	1	2	3	4
0	xx	-4	26	-1	8
1	5	0	27	22	24
2	61	63	50	50	63
3	20	24	22	27	0
4	7	8	-1	26	-4

RF Freq = 0.5 GHz @ -10 dBm  
 LO Freq = 0.4 GHz @ 0 dBm  
 All values in dBc below IF power level (RF - LO).

### Harmonics of LO

LO Freq GHz	nLO Spur at RF Port			
	1	2	3	4
0.3	17	36	31	39
0.4	10	40	20	33
0.5	6	32	18	31
0.6	6	34	23	33
0.7	6	28	34	41
0.8	6	26	48	xx

LO power = 0 dBm  
 All values in dBc below input LO level measured at RF port.

### Absolute Maximum Ratings

RF/IF Input	+27 dBm
LO Drive	+10 dBm
Bias Supply (Vdd)	+7 Vdc
Channel Temperature	150 °C
Continuous Pdiss (T = 85°C) (Derate 13.2 mW/°C above 85°C)	0.85 W
Storage Temperature	-65 to +150 °C
Operating Temperature	-40 to +85 °C
IF DC Current	±40 mA



ELECTROSTATIC SENSITIVE DEVICE  
OBSERVE HANDLING PRECAUTIONS

### Outline Drawing

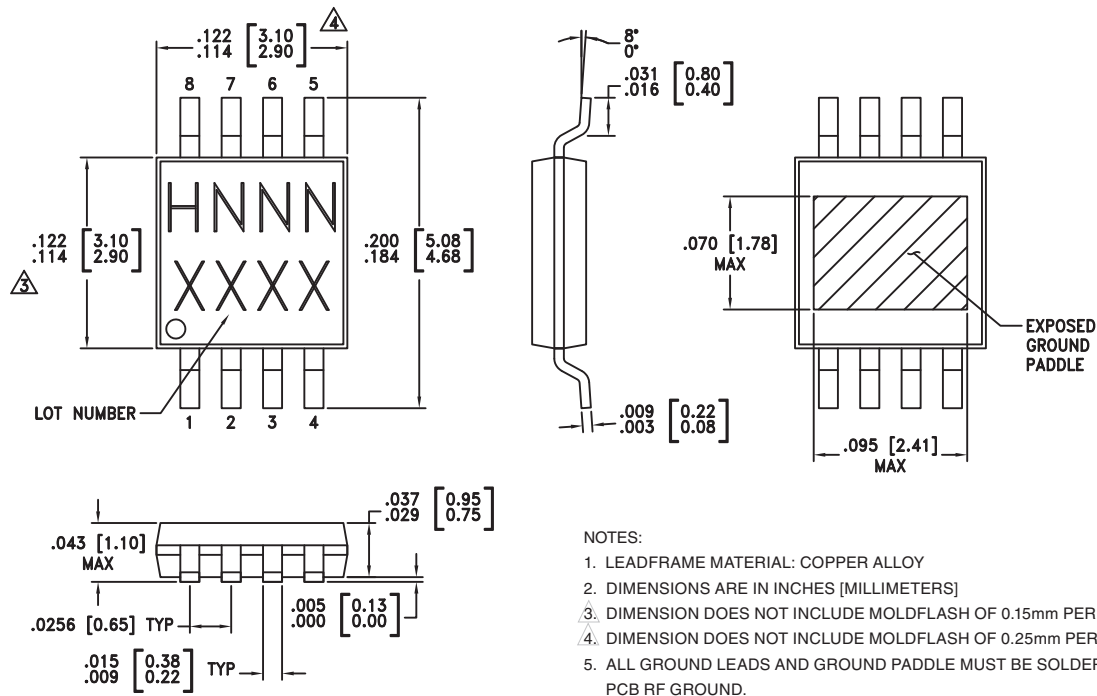

### Package Information

Part Number	Package Body Material	Lead Finish	MSL Rating	Package Marking <sup>[3]</sup>
HMC585MS8G	Low Stress Injection Molded Plastic	Sn/Pb Solder	MSL1 <sup>[1]</sup>	H585 XXXX
HMC585MS8GE	RoHS-compliant Low Stress Injection Molded Plastic	100% matte Sn	MSL1 <sup>[2]</sup>	H585 XXXX

[1] Max peak reflow temperature of 235 °C



[2] Max peak reflow temperature of 260 °C

[3] 4-Digit lot number XXXX

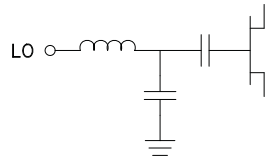

## HIGH IP3 GaAs MMIC MIXER with INTEGRATED LO AMPLIFIER, 400 - 650 MHz

### Pin Descriptions

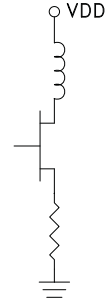
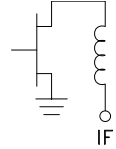
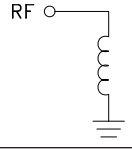
Pin Number	Function	Description	Interface Schematic
1	LO	This pin is AC coupled and matched to 50 Ohm.	
2	N/C	Not connected.	
3, 6, 7	GND	This pin must be connected to RF ground.	
4	Vdd	Power supply for LO amplifier. An external RF bypass capacitor is required.	
5	IF Port	This pin is DC coupled. For applications not requiring operation to DC this port should be DC blocked externally using a series capacitor. Choose value of capacitor to pass IF frequency desired. For operation to DC, this pin must not sink/source more than 40 mA of current or failure may result.	
8	RF Port	This pin is DC coupled and matched to 50 Ohm.	

**Evaluation PCB**

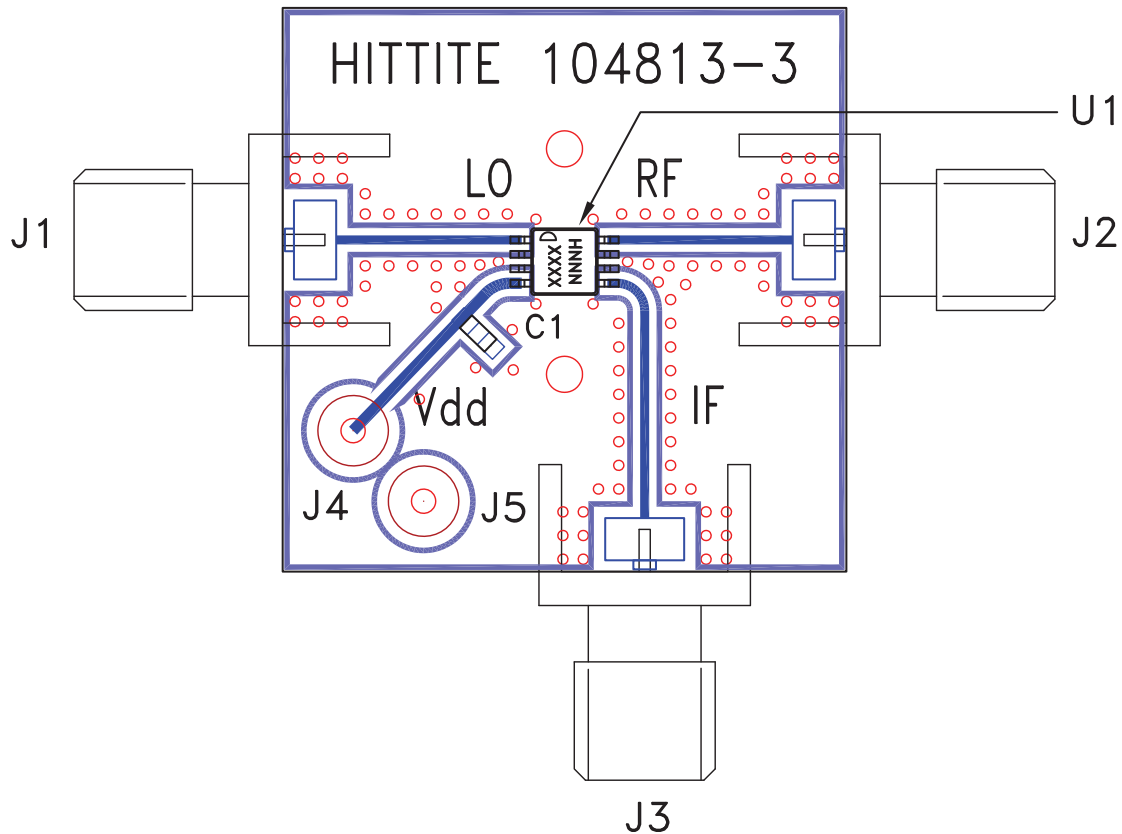

**List of Materials for Evaluation PCB 114445 [1]**

Item	Description
J1 - J3	PCB Mount SMA RF Connector
J4 - J5	DC Pin
C1	10,000 pF Chip Capacitor, 0603 Pkg.
U1	HMC585MS8G / HMC585MS8GE Mixer
PCB [2]	104813 Evaluation Board, 1.0" x 1.0"

[1] Reference this number when ordering complete evaluation PCB

[2] Circuit Board Material: Rogers 4350

The circuit board used in the final application should use RF circuit design techniques. Signal lines should have 50 ohm impedance while the package ground leads and exposed paddle should be connected directly to the ground plane similar to that shown. A sufficient number of via holes should be used to connect the top and bottom ground planes. The evaluation circuit board shown is available from Hittite upon request.