

THESE DRAWINGS ARE THE PROPERTY OF QUALTEK ELECTRONICS AND NOT TO BE REPRODUCED FOR OR COMMUNICATED TO A THIRD PARTY WITHOUT THE EXPRESS WRITTEN PERMISSION OF AN OFFICER OF QUALTEK ELECTRONICS.

REVISION			
REV.	DESCRIPTION	DATE	APPROVED
A	RoHS Compliancy	06-01-06	DP

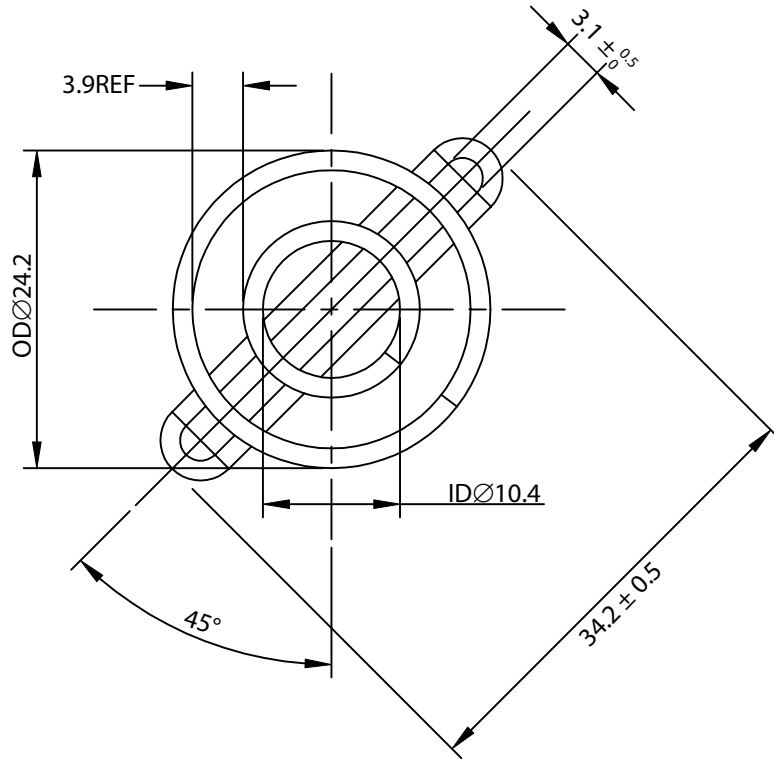

NOTES:

1. MATERIAL: C1008 BRIGHT BASIC WIRE
2. FINISH: BRIGHT NICKEL CHROME PLATING
3. 0.30 ± 0.05 DEPTH OF SERRATIONS ON WIRE
4. RING: $\varnothing 1.5 \pm 0.1\text{mm}$
RIB: $\varnothing 1.5 \pm 0.1\text{mm}$
5. GENERAL TOLERANCE UNLESS NOTED IS $\pm 0.5\text{mm}$
6. RoHS COMPLIANT

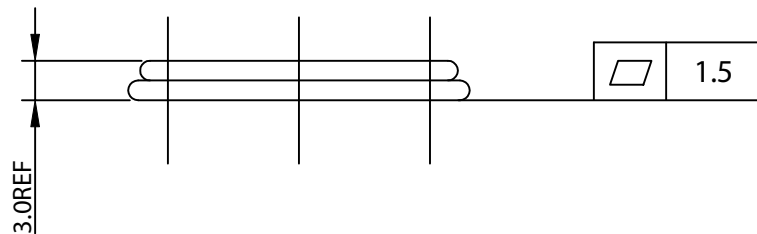

CONTROLLED

Dim range (mm)	Tolerance +/- (mm)	Qualtek Electronics Corp. FAN-S DIVISION		
		Part Number:	RoHS Compliant	
0-5	0.1	08245		
5-16	0.15	Description:	WIRE FORM FAN GUARD (25mm)	
16-64	0.2		UNIT: mm	REV: A
64-250	0.4			
250-1000	0.5	Drawn / Date	Checked / Date	Approved / Date
1000-1500	1.0	B. ZHANG 07-09-04	07-09-04	JJH / 07-09-04