

36-44GHz Variable Attenuator

GaAs Monolithic Microwave IC

Description

The CHT4699-QDG is a monolithic 36-44GHz Variable Voltage Attenuator.

It is designed for a wide range of applications, from military to commercial communication systems.

The circuit is manufactured with a MESFET process, 0.7 μ m gate length, via holes through the substrate, air bridges.

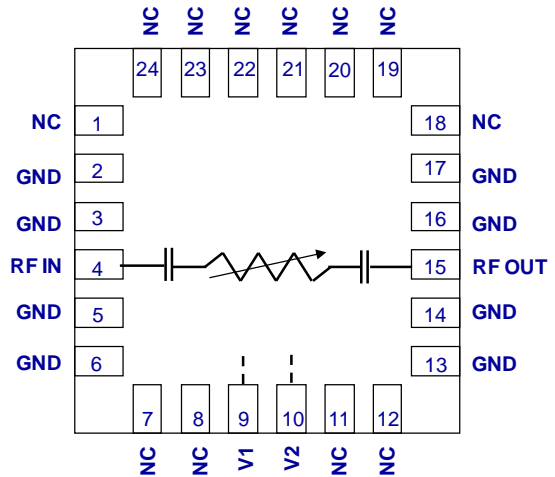

Main Features

- Broadband performances: 36-44GHz
- Minimum attenuation: 4dB
- 30dB dynamic range
- 27dBm input IP3
- DC bias: -5 to 0V
- 24L QFN4x4

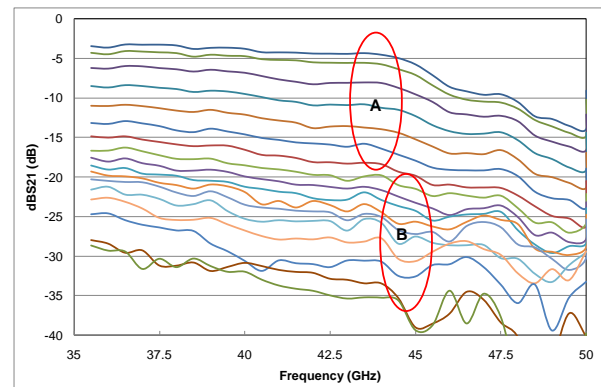

Main Electrical Characteristics

Tamb.= +25°C

Symbol	Parameter	Min	Typ	Max	Unit
Freq	Frequency range	36.0		44.0	GHz
Min Att	Minimum attenuation with V1=V2= -5V		-4		dB
Dyn	Dynamic range of attenuation		30		dB
IIP3	Input IP3 all attenuation		27		dBm

Electrical Characteristics

Tamb.= +25°C,

Symbol	Parameter	Min	Typ	Max	Unit
Freq	Frequency range	36		44	GHz
Min Att.	S21 (V1=-5V;V2=-5V)		-4		dB
Dyn	Attenuation dynamic		30		dB
RLin	Input Return loss (any attenuation)		-10		dB
RLout	Output Return loss (any attenuation)		-10		dB
Pin1dB	Input 1dB compression point (any attenuation)		20		dBm
IIP3	Input 3 rd order Intercept Point (any attenuation)		27		dBm

These values are representative of onboard measurements as defined on the drawing in paragraph "Evaluation mother board".

Absolute Maximum Ratings ⁽¹⁾

Tamb.= +25°C

Symbol	Parameter	Values	Unit
V1	V1 control voltage	-6 to +0.6	V
V2	V2 control voltage	-6 to +0.6	V
Pin	RF input power overdrive ⁽²⁾	+33	dBm
Ta	Operating temperature range	-40 to +85	°C
Tstg	Storage temperature range	-55 to +150	°C

⁽¹⁾ Operation of this device above anyone of these parameters may cause permanent damage.

⁽²⁾ Duration < 1s.

Typical Bias Conditions

Tamb.= +25°C

Symbol	Pad N°	Parameter	Values	Unit
V1	9	V1 control voltage	-5 to 0	V
V2	10	V2 control voltage	-5 to 0	V

For optimum linearity V1& V2 should be tuned in sequence.

Typical Package Sij parameters

Tamb.= +25°C, V1= -5V, V2= -5V, Minimum attenuation

Freq (GHz)	S11 (dB)	PhS11 (°)	S21 (dB)	PhS21 (°)	S12 (dB)	PhS12 (°)	S22 (dB)	PhS22 (°)
25	-12.6	-106	-3.2	176	-3.2	176	-12.9	-103
25.5	-11.0	-124	-3.5	156	-3.5	156	-11.2	-122
26	-9.8	-140	-3.6	137	-3.6	137	-9.8	-140
26.5	-8.8	-157	-3.8	118	-3.8	118	-8.9	-158
27	-8.3	-174	-3.9	99	-3.9	99	-8.3	-177
27.5	-7.9	170	-4.0	81	-4.0	81	-7.9	165
28	-7.8	154	-4.1	62	-4.1	62	-7.8	147
28.5	-7.8	139	-4.1	44	-4.1	44	-7.8	130
29	-7.9	124	-4.1	25	-4.1	25	-7.9	113
29.5	-8.1	108	-3.9	7	-3.9	7	-8.1	95
30	-8.4	92	-3.8	-13	-3.8	-13	-8.4	77
30.5	-9.1	76	-3.7	-33	-3.7	-33	-9.1	60
31	-10.0	59	-3.6	-52	-3.6	-52	-10.0	42
31.5	-11.3	43	-3.6	-73	-3.6	-73	-11.3	24
32	-12.7	27	-3.6	-92	-3.6	-92	-13.0	8
32.5	-14.7	11	-3.7	-112	-3.7	-112	-14.9	-6
33	-17.1	-4	-3.6	-131	-3.6	-131	-16.8	-18
33.5	-20.5	-21	-3.5	-151	-3.5	-151	-19.1	-29
34	-25.9	140	-3.5	-171	-3.4	-171	-21.7	146
34.5	-39.6	98	-3.4	168	-3.4	168	-24.4	143
35	-31.7	-51	-3.3	148	-3.3	148	-27.3	142
35.5	-25.6	-72	-3.3	127	-3.3	127	-29.9	139
36	-23.1	-81	-3.1	106	-3.1	106	-34.9	110
36.5	-21.2	-88	-3.1	84	-3.1	84	-33.3	-13
37	-19.4	-93	-3.2	63	-3.2	63	-25.9	-53
37.5	-17.4	-102	-3.2	40	-3.2	40	-20.7	-76
38	-15.7	-111	-3.3	18	-3.3	18	-17.2	-97
38.5	-14.1	-122	-3.4	-4	-3.5	-4	-14.9	-117
39	-12.8	-135	-3.8	-26	-3.8	-26	-13.1	-133
39.5	-11.7	-148	-4.0	-47	-4.0	-47	-11.6	-151
40	-10.6	-162	-4.1	-69	-4.1	-69	-10.4	-168
40.5	-9.8	-178	-4.3	-90	-4.3	-90	-9.5	174
41	-9.4	165	-4.4	-112	-4.4	-112	-9.1	158
41.5	-9.4	148	-4.7	-133	-4.7	-133	-9.2	142
42	-9.5	133	-4.6	-154	-4.6	-154	-9.2	128
42.5	-10.1	117	-4.5	-177	-4.5	-176	-9.8	112
43	-11.3	103	-4.5	160	-4.5	160	-10.9	99
43.5	-13.1	95	-4.5	136	-4.5	136	-12.7	92
44	-14.6	98	-4.7	109	-4.7	109	-14.2	98
44.5	-13.7	110	-5.3	84	-5.3	84	-12.8	113
45	-10.9	108	-6.0	59	-5.9	59	-9.6	111
45.5	-8.5	96	-6.9	35	-6.9	35	-7.3	99
46	-6.9	79	-7.9	13	-7.9	13	-5.7	85
46.5	-5.7	64	-8.9	-6	-8.9	-6	-4.6	70
47	-4.9	-134	-9.7	-26	-9.7	-26	-3.7	-127
47.5	-4.3	-152	-10.5	-46	-10.5	-46	-3.2	-144
48	-4.1	-169	-11.3	-64	-11.3	-64	-2.9	-158
48.5	-3.7	176	-11.6	-82	-11.5	-81	-2.3	-172
49	-3.6	159	-12.1	-101	-12.1	-102	-2.3	173
49.5	-3.6	143	-12.7	-119	-12.7	-119	-2.4	159
50	-3.8	127	-13.0	-138	-13.0	-138	-2.3	146

Refer to the "definition of Sij reference planes" section below

Typical Package Sij parameters

Tamb.= +25°C, V1= 0V, V2= 0V, Maximum attenuation

Freq (GHz)	S11 (dB)	PhS11 (°)	S21 (dB)	PhS21 (°)	S12 (dB)	PhS12 (°)	S22 (dB)	PhS22 (°)
25	-12.5	-150	-29.2	178	-29.1	178	-12.7	-153
25.5	-12.2	-161	-29.3	162	-29.3	162	-12.6	-165
26	-12.0	-173	-29.1	142	-29.2	142	-12.4	-177
26.5	-11.8	176	-29.3	125	-29.2	125	-12.3	171
27	-11.8	165	-29.2	107	-28.9	107	-12.3	158
27.5	-11.9	153	-29.2	88	-29.2	88	-12.4	145
28	-12.0	142	-29.4	71	-29.4	71	-12.6	132
28.5	-12.3	131	-29.1	53	-29.1	53	-12.8	120
29	-12.7	121	-29.1	36	-29.1	35	-13.1	108
29.5	-13.0	111	-29.5	18	-29.4	18	-13.4	95
30	-13.4	101	-29.3	2	-29.2	2	-13.9	84
30.5	-14.1	90	-28.9	-15	-29.0	-16	-14.3	72
31	-14.8	80	-29.2	-33	-29.2	-33	-15.1	60
31.5	-15.8	71	-29.2	-50	-29.1	-50	-16.0	49
32	-16.8	65	-29.3	-66	-29.2	-66	-17.2	39
32.5	-17.8	59	-29.2	-83	-29.3	-83	-18.5	30
33	-18.9	55	-29.3	-98	-29.2	-99	-19.7	24
33.5	-20.0	53	-29.4	-118	-29.5	-117	-20.9	19
34	-20.9	-125	-29.8	-131	-29.7	-131	-21.5	-161
34.5	-21.1	-124	-29.6	-148	-29.7	-148	-22.3	-164
35	-21.1	-122	-29.7	-166	-29.4	-165	-23.4	-163
35.5	-20.6	-120	-30.1	177	-29.9	176	-24.0	-159
36	-19.7	-121	-30.9	156	-30.7	156	-24.1	-152
36.5	-19.1	-127	-31.6	144	-31.8	145	-23.9	-146
37	-18.8	-130	-31.9	129	-32.1	129	-22.7	-144
37.5	-17.9	-134	-32.3	112	-32.3	112	-21.3	-146
38	-17.2	-139	-33.7	97	-33.5	94	-20.0	-149
38.5	-16.3	-146	-34.1	80	-34.1	79	-18.4	-154
39	-15.6	-154	-35.9	70	-35.8	70	-17.2	-160
39.5	-15.0	-161	-36.4	55	-37.0	55	-16.2	-168
40	-14.3	-169	-38.6	45	-38.6	44	-15.1	-176
40.5	-13.7	-178	-39.3	28	-39.2	32	-14.2	176
41	-13.0	174	-43.1	32	-42.9	27	-13.2	169
41.5	-12.4	165	-46.0	55	-45.2	43	-12.5	161
42	-11.6	156	-41.5	55	-41.7	55	-11.3	154
42.5	-10.7	145	-38.8	49	-39.0	48	-10.3	143
43	-9.9	133	-36.4	30	-37.0	35	-9.5	131
43.5	-9.3	120	-35.7	13	-36.1	13	-8.7	120
44	-8.9	106	-35.0	-11	-34.6	-10	-8.2	107
44.5	-8.8	95	-35.4	-36	-35.4	-36	-7.8	97
45	-8.4	83	-38.0	-63	-37.5	-58	-7.2	86
45.5	-8.1	72	-39.6	-61	-39.0	-67	-6.9	76
46	-7.5	60	-40.9	-76	-39.7	-77	-6.3	66
46.5	-7.0	50	-42.3	-76	-42.3	-81	-5.8	56
47	-6.4	-143	-43.4	-71	-42.4	-68	-5.2	-136
47.5	-6.0	-158	-40.3	-87	-40.9	-78	-4.7	-150
48	-5.7	-171	-39.9	-90	-41.0	-82	-4.3	-162
48.5	-5.2	176	-38.0	-105	-37.8	-103	-3.7	-172
49	-5.0	161	-38.9	-119	-38.2	-126	-3.5	174
49.5	-4.8	146	-38.2	-135	-37.9	-138	-3.4	162
50	-4.7	132	-37.7	-160	-38.4	-159	-3.2	149

Refer to the "definition of Sij reference planes" section below

Typical Board Measurements

Tamb.= +25°C

Measurements in the package access planes

Gain versus control voltage

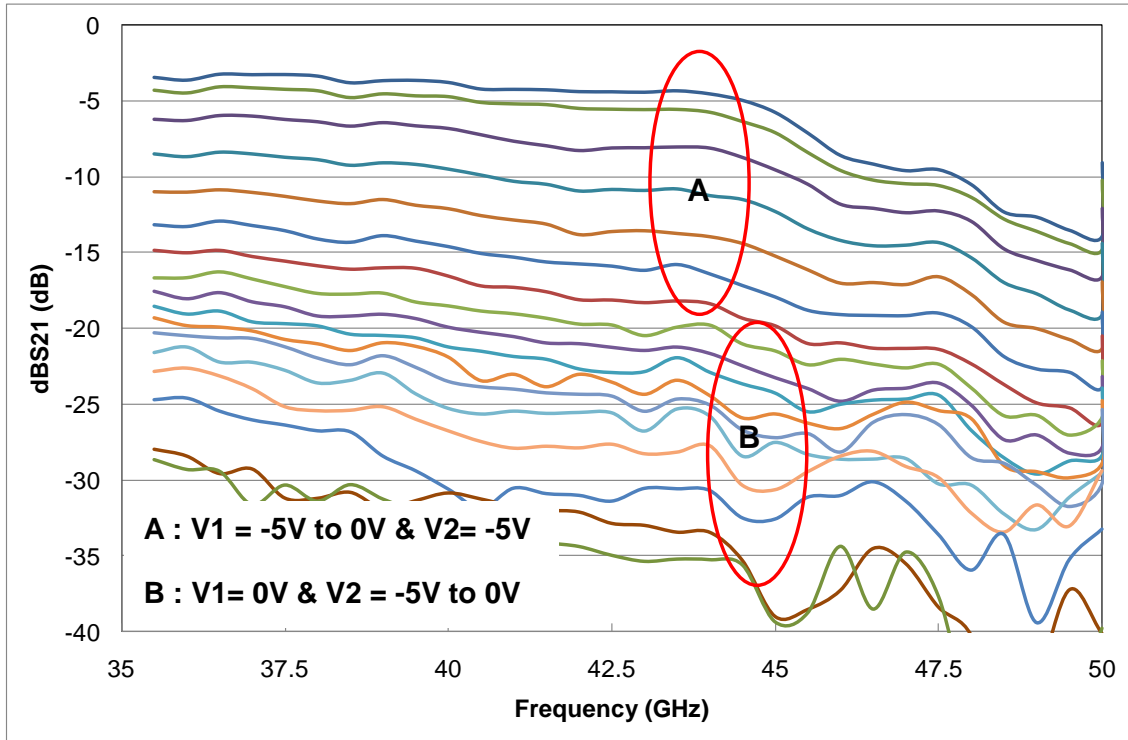

S11 versus control voltage

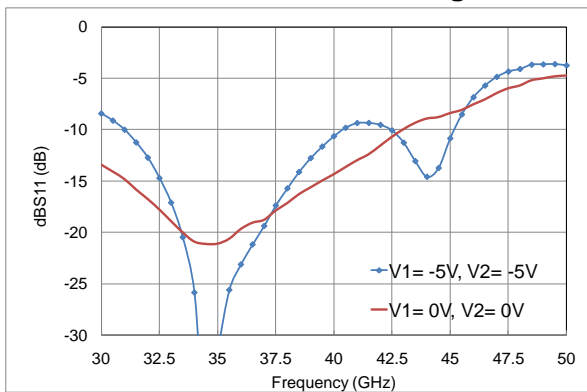

S22 versus control voltage

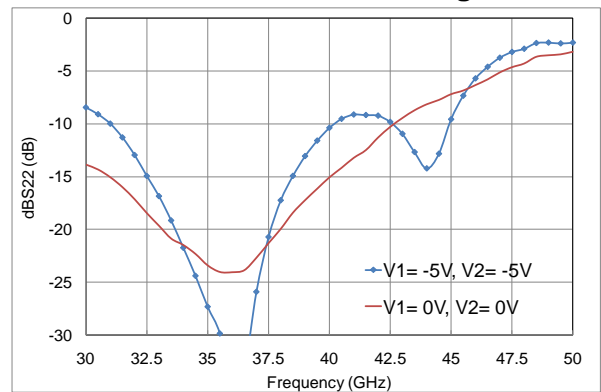

Typical Board Measurements

Tamb.= +25°C

Measurements in the package access planes

Gain versus control voltage

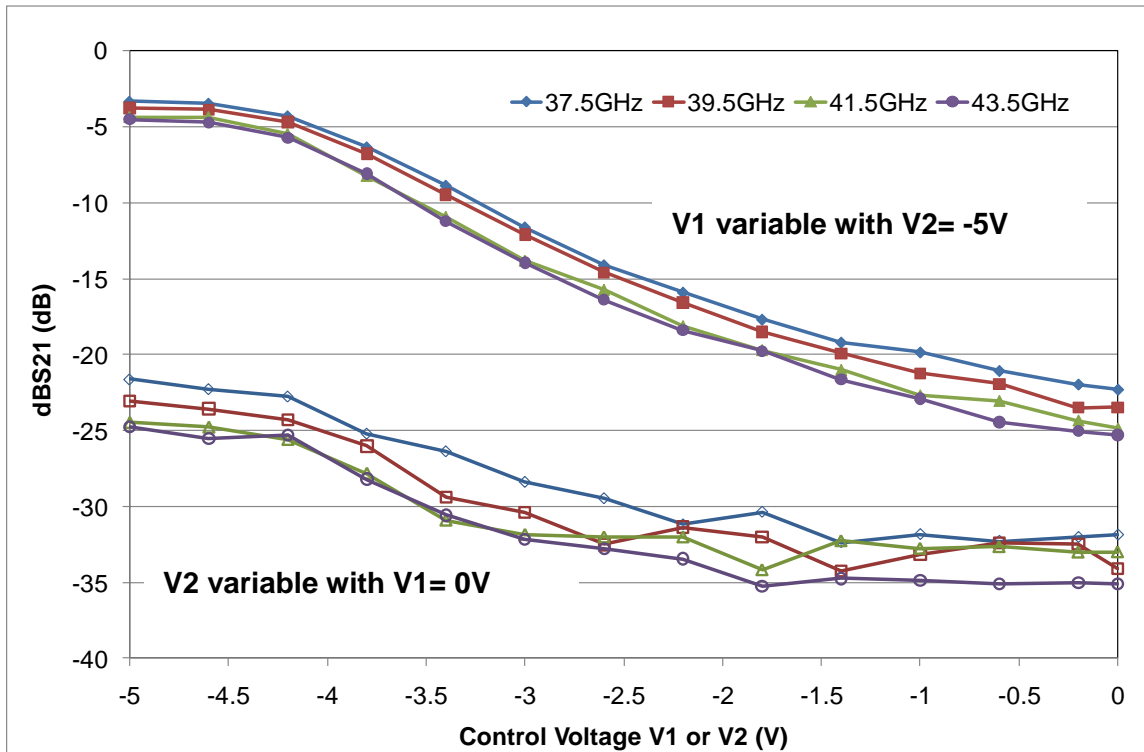

Gain versus input power & V1 control voltage with V2 = -5V
38GHz 42GHz

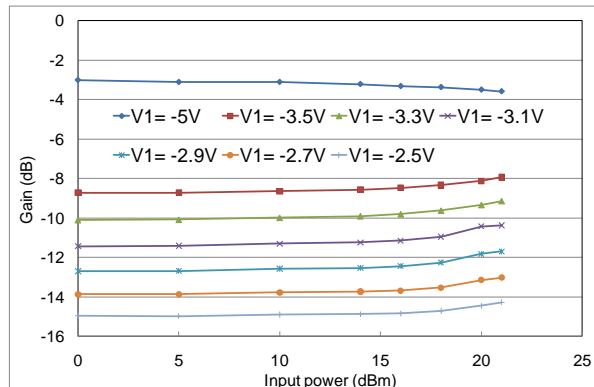
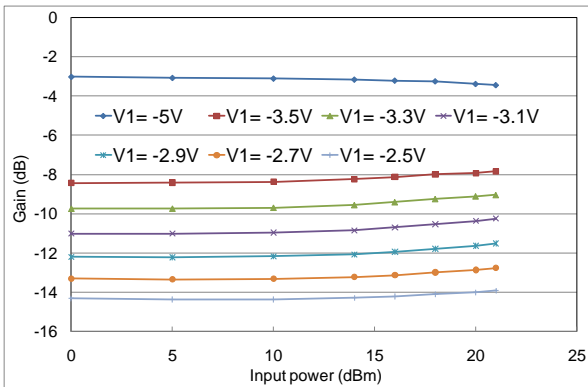

Typical Board Measurements

Tamb.= +25°C

Measurements in the package access planes

Input IP3 versus input power & V1 control voltage at 38GHz with V2= -5V

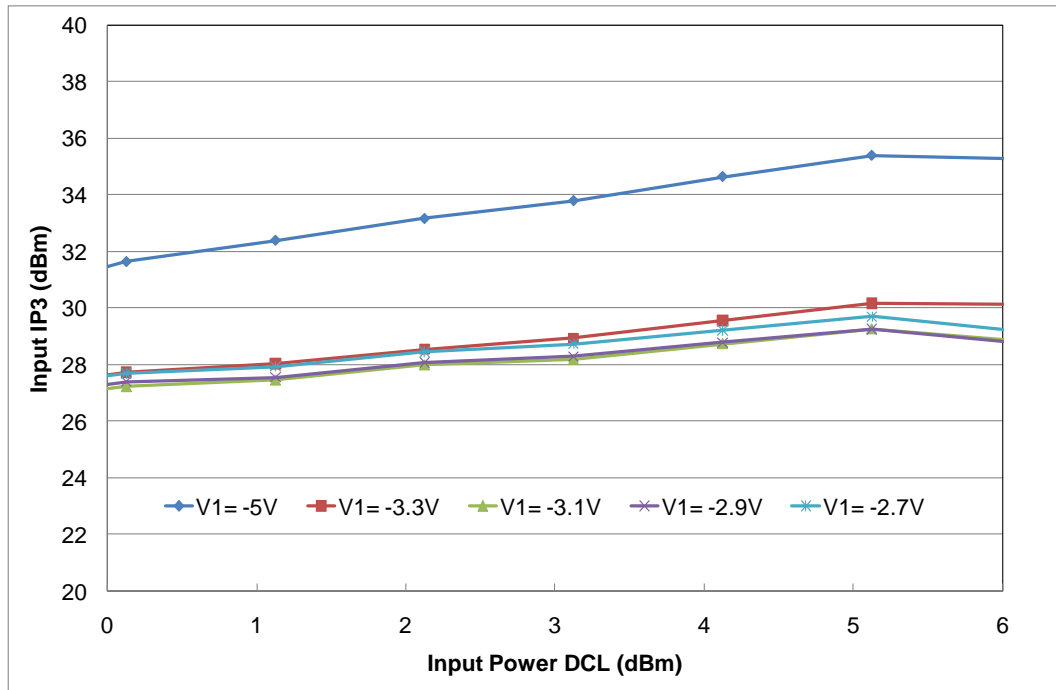

Input IP3 versus input power & V1 control voltage at 42GHz with V2= -5V

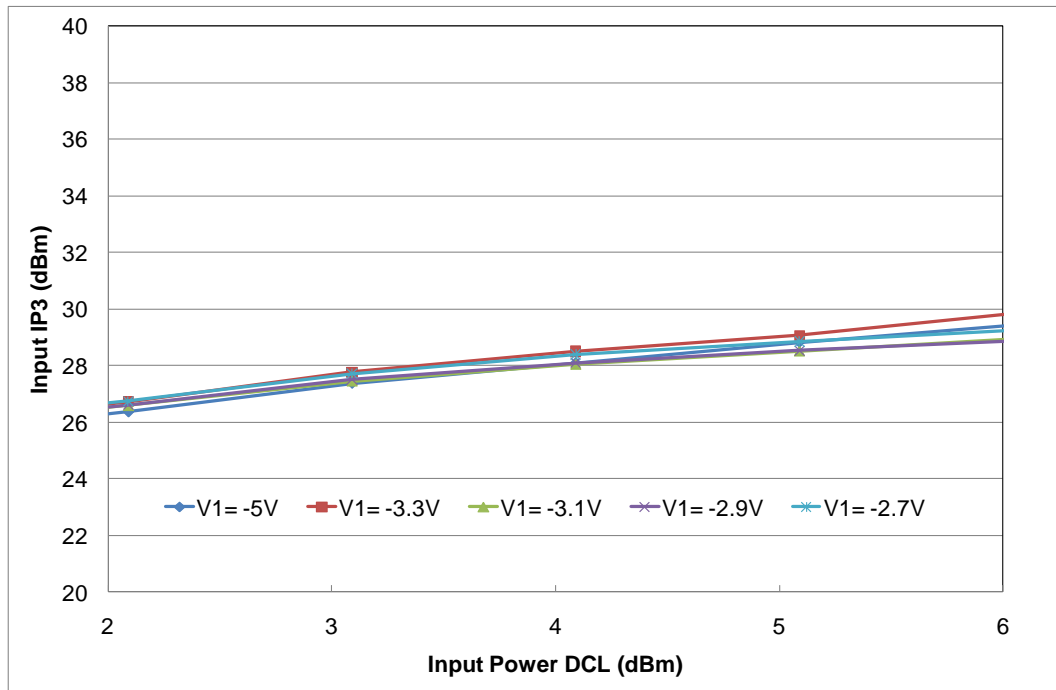

Typical Board Measurements

Tamb.= +25°C

Measurements in the package access planes

Input IP3 versus input power with V1= V2

38GHz

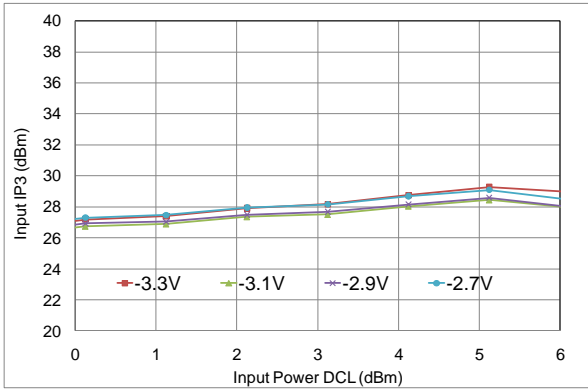

42GHz

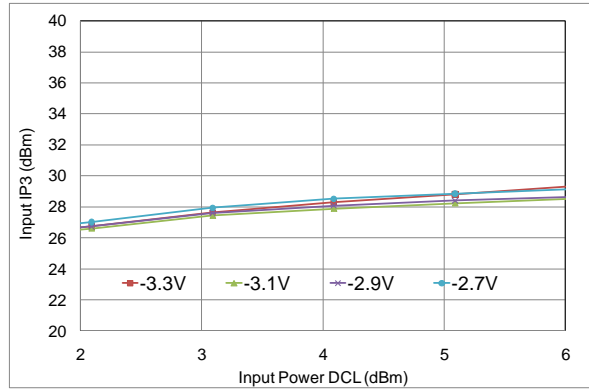

Gain versus frequency and biasing option

V1 variable with V2=-5V

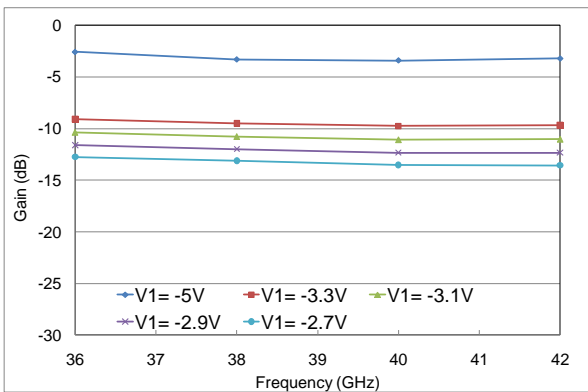

V1=V2

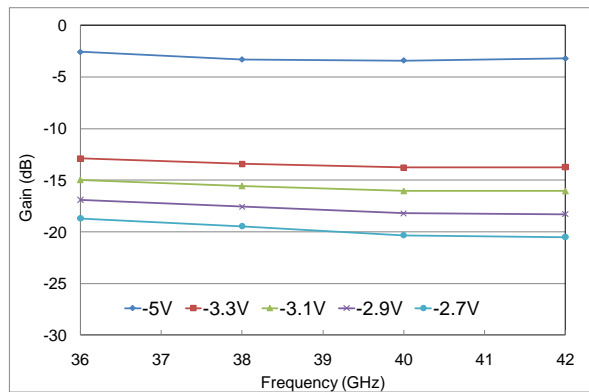

Package outline ⁽¹⁾

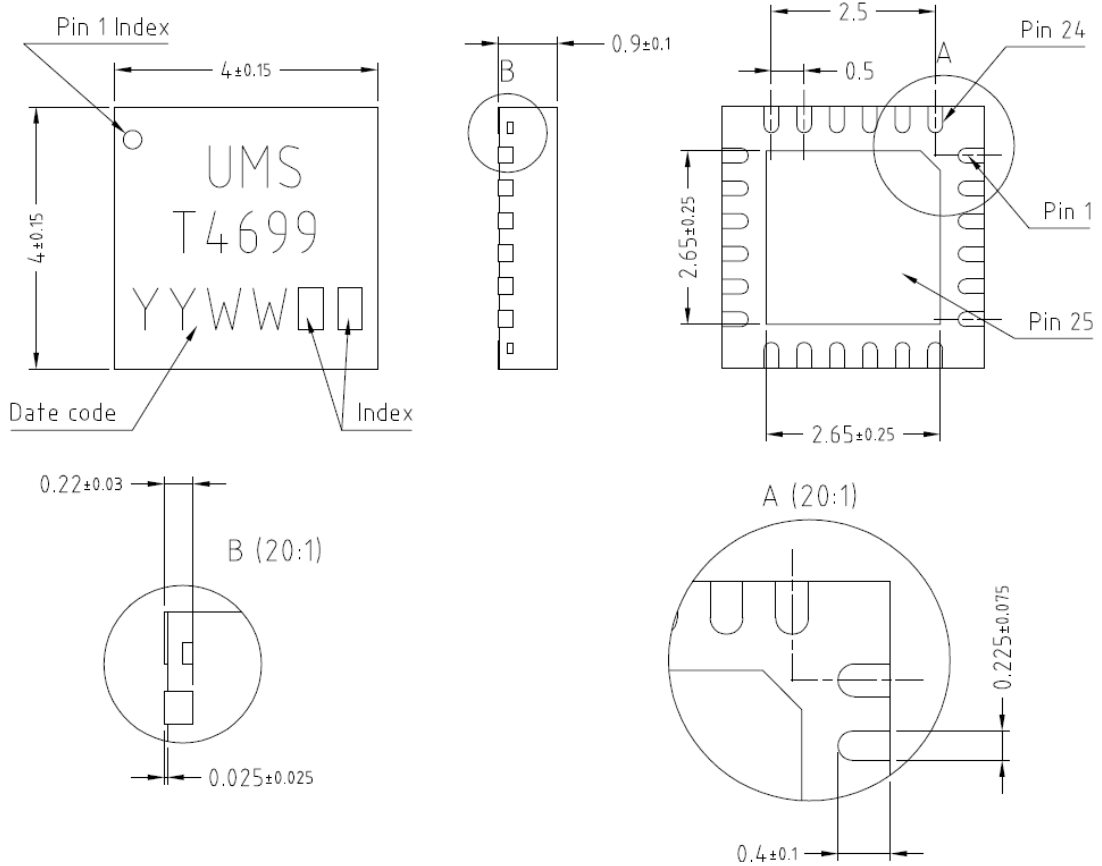

Matt tin, Lead Free	(Green)	1- Nc	9- V1	17- Gnd ⁽²⁾
Units :	mm	2- Gnd ⁽²⁾	10- V2	18- Nc
From the standard :	JEDEC MO-220	3- Gnd ⁽²⁾	11- Nc	19- Nc
	(VGGD)	4- RF IN	12- Nc	20- Nc
	25- GND	5- Gnd ⁽²⁾	13- Gnd ⁽²⁾	21- Nc
		6- Gnd ⁽²⁾	14- Gnd ⁽²⁾	22- Nc
		7- Nc	15- RF out	23- Nc
		8- Nc	16- Gnd ⁽²⁾	24- Nc

⁽¹⁾ The package outline drawing included to this data-sheet is given for indication. Refer to the application note AN0017 (<http://www.ums-gaas.com>) for exact package dimensions.

⁽²⁾ It is strongly recommended to ground all pins marked “Gnd” through the PCB board. Ensure that the PCB board is designed to provide the best possible ground to the package.

Evaluation mother board

- Compatible with the proposed footprint.
- Based on typically Ro4003 / 8mils or equivalent.
- Using a micro-strip to coplanar transition to access the package.
- Recommended for the implementation of this product on a module board.
- Decoupling capacitors of 10nF $\pm 10\%$ are recommended for all DC accesses.
- See application note AN0017 for details.

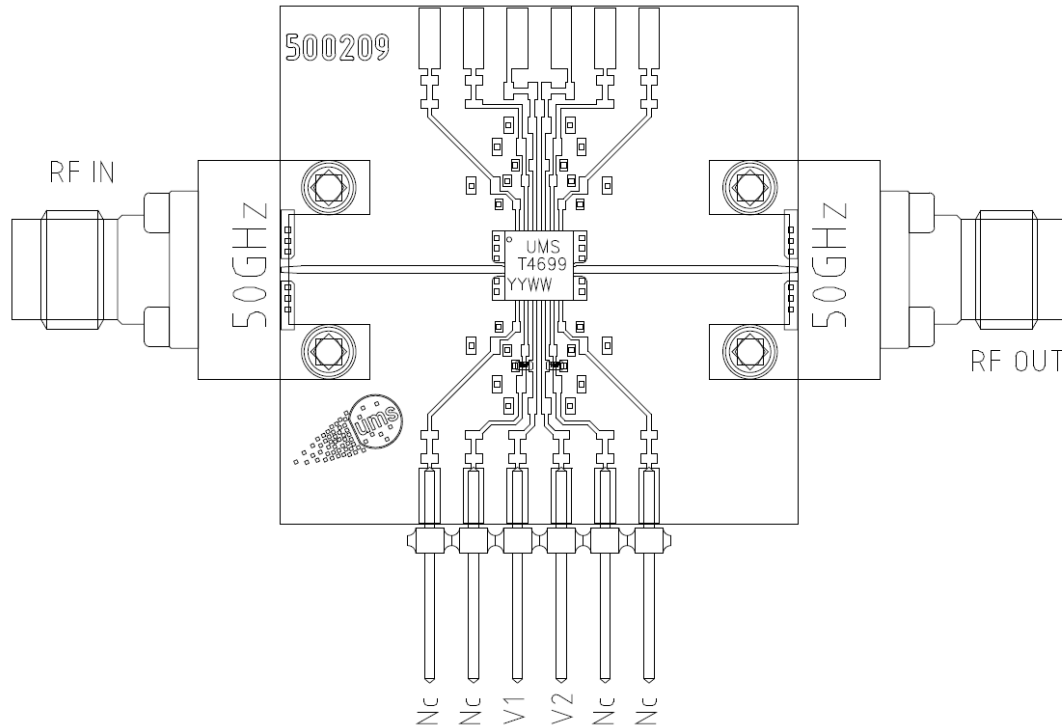

Definition of the Sij reference planes

The reference planes used for Sij measurements given above are symmetrical from the symmetrical axis of the package (see drawing beside). The input and output reference planes are located at 3.18mm offset (input wise and output wise respectively) from this axis. Then, the given Sij parameters incorporate the land pattern of the evaluation motherboard recommended in paragraph "Evaluation mother board".

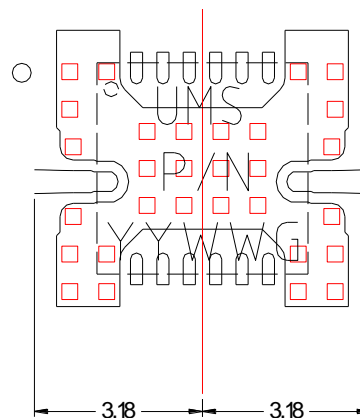

Biasing sequence

To obtain good performances in linearity, biasing voltage should be applied as following:

- Control of 1st stage attenuation with V1 from -5V to 0V, with V2 fixed at -5V
- Control of 2nd stage with V2 from -5V to 0V, with V1 fixed at 0V

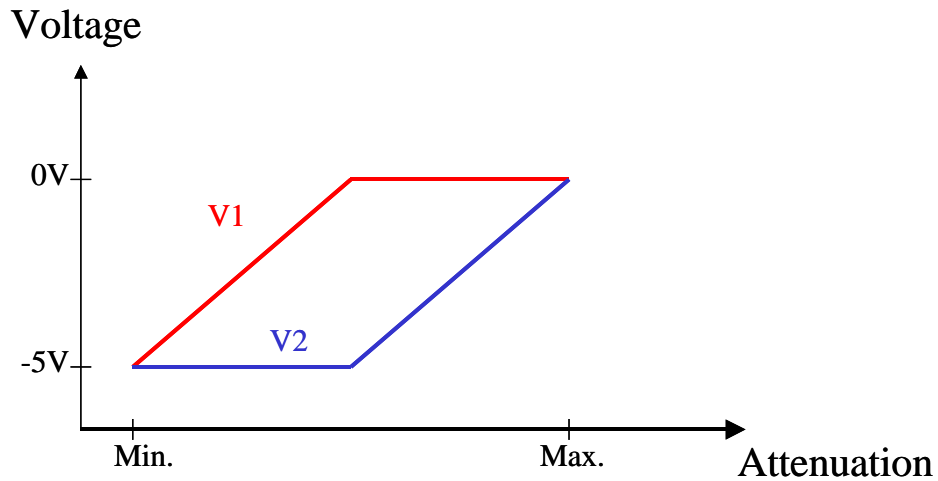

This part could be also driven in Single Voltage Control, applying the same voltage from -5V to 0V on V1 and V2.

Recommended package footprint

Refer to the application note AN0017 available at <http://www.ums-gaas.com> for package footprint recommendations and exact package dimensions.

SMD mounting procedure

For the mounting process standard techniques involving solder paste and a suitable reflow process can be used. For further details, see application note AN0017 available at <http://www.ums-gaas.com>.

Recommended environmental management

UMS products are compliant with the regulation in particular with the directives RoHS N°2011/65 and REACH N°1907/2006. More environmental data are available in the application note AN0019 also available at <http://www.ums-gaas.com>.

Recommended ESD management

Refer to the application note AN0020 available at <http://www.ums-gaas.com> for ESD sensitivity and handling recommendations for the UMS package products.

Ordering Information

QFN 4x4 RoHS compliant package:

CHT4699-QDG

Stick: XY = 20

Tape & reel: XY = 21

Information furnished is believed to be accurate and reliable. However **United Monolithic Semiconductors S.A.S.** assumes no responsibility for the consequences of use of such information nor for any infringement of patents or other rights of third parties which may result from its use. No license is granted by implication or otherwise under any patent or patent rights of **United Monolithic Semiconductors S.A.S.** Specifications mentioned in this publication are subject to change without notice. This publication supersedes and replaces all information previously supplied. **United Monolithic Semiconductors S.A.S.** products are not authorised for use as critical components in life support devices or systems without express written approval from **United Monolithic Semiconductors S.A.S.**