

### Typical Applications

Prescaler for DC to C Band PLL Applications:

- UNII, Point-to-Point & VSAT Radios
- 802.11a & HiperLAN WLAN
- Fiber Optic
- Cellular / 3G Infrastructure

### Features

- Ultra Low SSB Phase Noise: -150 dBc/Hz
- Single-Ended I/O's
- Output Power: -2 to -3.5 dBm
- Single DC Supply: +3V @ 53 mA
- 9 mm<sup>2</sup> Ultra Small Package: SOT26

### Functional Diagram



### General Description

The HMC433(E) is a low noise Divide-by-4 Static Divider utilizing InGaP GaAs HBT technology in ultra small surface mount SOT26 plastic packages. This device operates from DC (with a square wave input) to 8 GHz input frequency with a single +3V DC supply. Single-ended inputs and outputs reduce component count and cost. The low additive SSB phase noise of -150 dBc/Hz at 100 kHz offset helps the user maintain good system noise performance.

### Electrical Specifications, $T_A = +25^\circ\text{C}$ , 50 Ohm System, $V_{CC} = +3V$

Parameter	Conditions	Min.	Typ.	Max.	Units
Maximum Input Frequency		8	8.5		GHz
Minimum Input Frequency	Sine Wave Input. [1]		0.2		GHz
Input Power Range	$F_{in} = 1$ to 6 GHz	-12		+12	dBm
	$F_{in} = 6$ to 8 GHz	-3		+10	dBm
Output Power	$F_{in} = 4$ GHz	-5.0	-2.0		dBm
	$F_{in} = 8$ GHz	-6.5	-3.5		dBm
Reverse Leakage	RF Output Terminated, $F_{in} = 4$ GHz, $P_{in} = 0$ dBm		-25		dBm
SSB Phase Noise (100 kHz offset)	$P_{in} = 0$ dBm, $F_{in} = 4$ GHz		-150		dBc/Hz
Output Transition Time	$P_{in} = 0$ dBm, $F_{out} = 882$ MHz		120		ps
Supply Current ( $I_{CC}$ )	$V_{CC} = +3.0V$		53	71	mA

1. Divider will operate down to DC for square-wave input signal.

**Input Sensitivity Window,  $T = 25\text{ }^\circ\text{C}$**



**Input Sensitivity Window vs. Temperature**

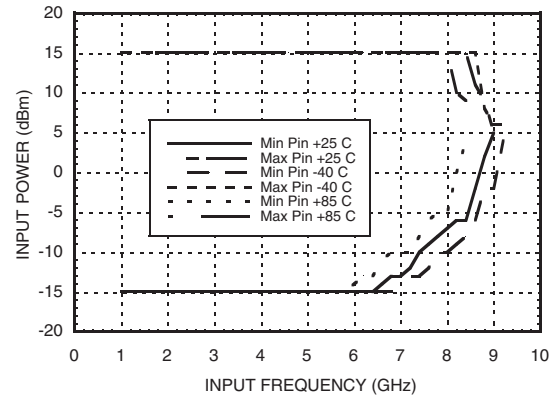

**Output Power vs. Temperature**



**SSB Phase Noise**

**Performance,  $P_{in} = 0\text{ dBm}$ ,  $T = 25\text{ }^\circ\text{C}$**

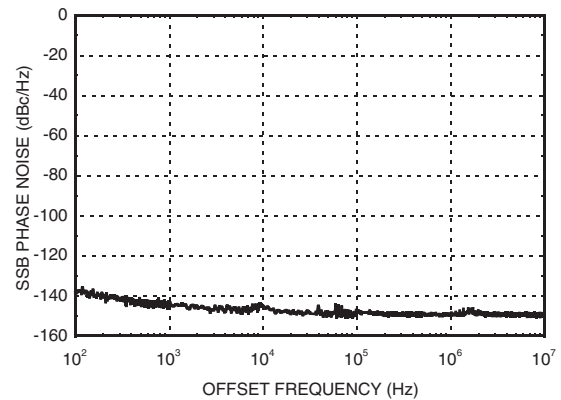

**Output Harmonic**

**Content,  $P_{in} = 0\text{ dBm}$ ,  $T = 25\text{ }^\circ\text{C}$**

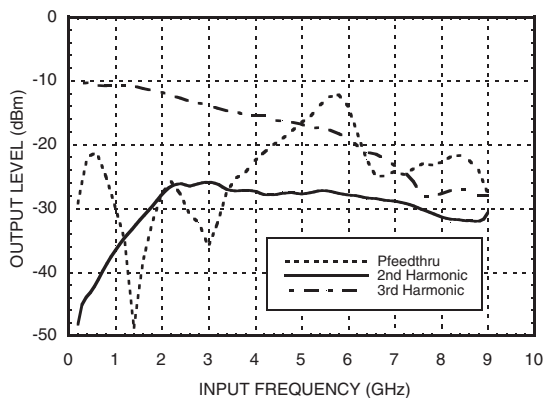

**Reverse Leakage,  $P_{in} = 0\text{ dBm}$ ,  $T = 25\text{ }^\circ\text{C}$**

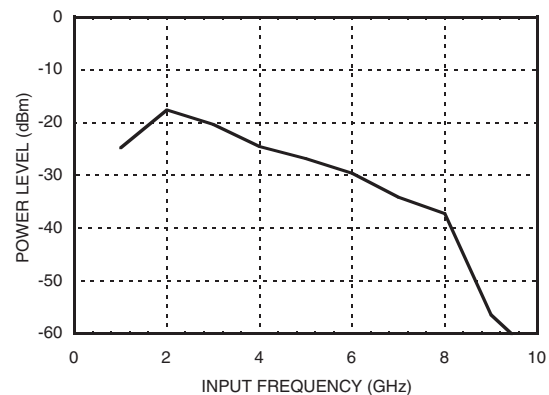



**Output Voltage Waveform,  
Pin= 0 dBm, Fout= 882 MHz, T= 25 °C**



**Absolute Maximum Ratings**

RF Input Power (Vcc = +3V)	15 dBm
Nominal +3V Supply to GND	-0.3V to +3.5V
Max Peak Flow Temperature	260 °C
Storage Temperature	-65 to +125 °C

**Reliability Information**

Junction Temperature to Maintain 1 Million Hour MTTF	135 °C
Nominal Junction Temperature (T = 85 °C)	99 °C
Thermal Resistance (Junction to GND Paddle, 3V Supply)	83 °C/W
Operating Temperature	-40 to +85 °C

DC blocking capacitors are required at RF input and RF output ports.  
Choose value for lowest frequency of operation.



**ELECTROSTATIC SENSITIVE DEVICE  
OBSERVE HANDLING PRECAUTIONS**

**Typical Supply Current vs. Vcc**

Vcc (V)	Icc (mA)
2.70	42
3.0	53
3.30	63

Note: Divider will operate over full voltage range shown above

**Outline Drawing**

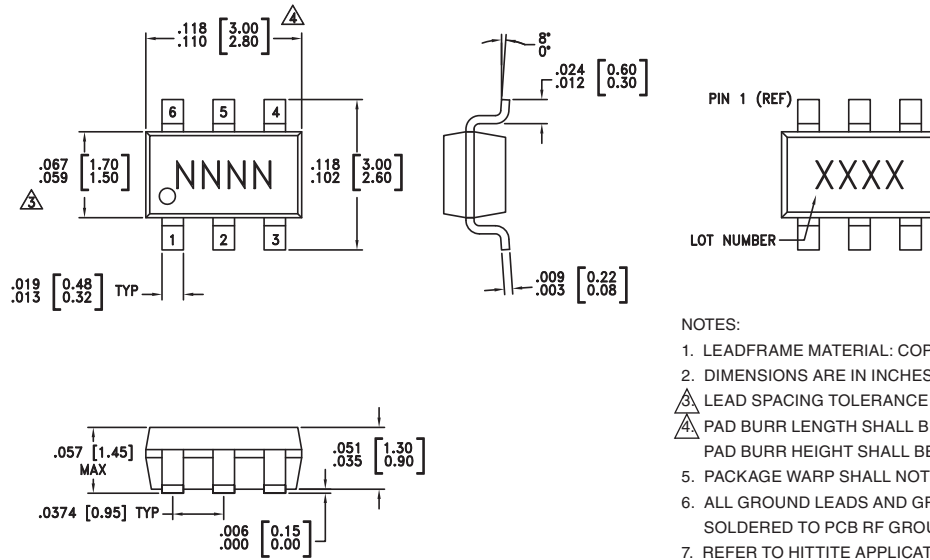

- NOTES:
1. LEADFRAME MATERIAL: COPPER ALLOY
  2. DIMENSIONS ARE IN INCHES [MILLIMETERS]
  3. LEAD SPACING TOLERANCE IS NON-CUMULATIVE.
  4. PAD BURR LENGTH SHALL BE 0.15mm MAXIMUM. PAD BURR HEIGHT SHALL BE 0.05mm MAXIMUM.
  5. PACKAGE WARP SHALL NOT EXCEED 0.05mm.
  6. ALL GROUND LEADS AND GROUND PADDLE MUST BE SOLDERED TO PCB RF GROUND.
  7. REFER TO HITTITE APPLICATION NOTE FOR SUGGESTED LAND PATTERN.

**Package Information**

Part Number	Package Body Material	Lead Finish	MSL Rating	Package Marking <sup>[3]</sup>
HMC433	Low Stress Injection Molded Plastic	Sn/Pb Solder	MSL1 <sup>[1]</sup>	H433 XXXX
HMC433E	RoHS-compliant Low Stress Injection Molded Plastic	100% matte Sn	MSL1 <sup>[2]</sup>	433E XXXX

[1] Max peak reflow temperature of 235 °C  
 [2] Max peak reflow temperature of 260 °C  
 [3] 4-Digit lot number XXXX

**Pin Description**

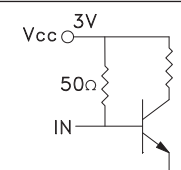
Pin Number	Function	Description	Interface Schematic
1, 4	N/C	The pins are not connected internally; however, all data shown herein was measured with these pins connected to RF/DC ground externally.	
2	GND	Pin must connect to RF/DC ground.	
3	IN	RF input must be DC blocked.	



### Pin Description (Continued)

Pin Number	Function	Description	Interface Schematic
5	Vcc	Supply voltage 3V ± 0.3V.	
6	OUT	Divided output must be DC blocked.	

### Application Circuit



Note:  
DC blocking capacitor values (C1, C2) and DC decoupling capacitor values (C3, C4) are chosen for lowest frequency of operation.

### Evaluation PCB



### List of Materials for Evaluation PCB 105675 [1]

Item	Description
J1 - J2	PCB Mount SMA RF Connector
J3 - J4	DC Pin
C1 - C2	100 pF Capacitor, 0402 Pkg.
C3	1000 pF Capacitor, 0402 Pkg.
C4	10 μF Tantalum Capacitor, 1206 Pkg.
U1	HMC433 / HMC433E Divide-by-4
PCB [2]	105199 Eval Board

[1] Reference this number when ordering complete evaluation PCB

[2] Circuit Board Material: Rogers 4350

The circuit board used in the application should use RF circuit design techniques. Signal lines should have 50 Ohm impedance while the package ground leads should be connected directly to the ground plane similar to that shown. A sufficient number of via holes should be used to connect the top and bottom ground planes. The evaluation circuit board shown is available from Hittite upon request.