



三合微科股份有限公司
SAMHOP Microelectronics Corp.

SM7516

3W STEREO AUDIO POWER AMPLIFIER WITH ADVANCED DC VOLUME CONTROL

SM7516

**3W STEREO AUDIO POWER AMPLIFIER
WITH ADVANCED DC VOLUME CONTROL**

**REV. 0.1
(Preliminary)**

September 12, 2007

**The information in this document is subject to change without notice.
© SAMHOP Microelectronics Corp. All Rights Reserved.**

台北縣新店市民權路100號7樓
7F, No. 100, Min-Chyuan Road, Hsintien, Taipei Hsien, Taiwan, R.O.C.
TEL: 886-2-2218-3978/2820 FAX: 886-2-2218-3320
Email : info@samhop.com.tw

**3W STEREO AUDIO POWER AMPLIFIER WITH ADVANCED DC VOLUME CONTROL****GENERAL DESCRIPTION**

The SM7516 is a stereo audio power amplifier that drives 3 W/channel of continuous RMS power into a 3- Ω load. Advanced dc volume control minimizes external components and allows BTL (speaker) volume control and SE (headphone) volume control. Notebook and pocket PCs benefit from the integrated feature set that minimizes external components without sacrificing functionality.

To simplify design, the speaker volume level is adjusted by applying a dc voltage to the VOLUME terminal.

FEATURES

- * Advanced DC Volume Control With 2-dB Steps
From -40 dB to 20 dB
- Maximum Volume Setting for SE Mode
- Adjustable SE Volume control
Referenced to BTL Volume Control
- * 3 W Into 3- Ω Speakers

APPLICATIONS

- * Notebook PC
- * LCD Monitors
- * Portable DVD Player
- * Digital photo frame

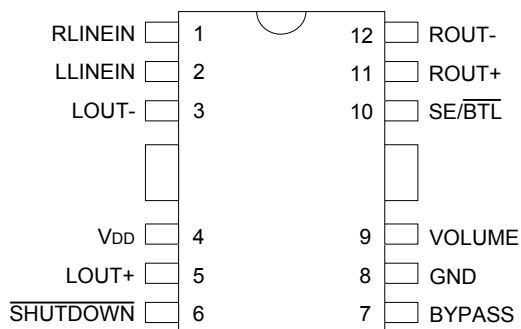
PIN ASSIGNMENTS (TOP VIEW)**SM7516** HDIP 12PIN

**3W STEREO AUDIO POWER AMPLIFIER WITH ADVANCED DC VOLUME CONTROL****PIN DESCRIPTIONS**

No.	Pin name	I / O	Function
1	RLINEIN	I	Right channel input signal.
2	LLINEIN	I	Left channel input signal.
3	LOUT -	O	Left channel negative audio output.
4	V _{DD}	-	Supply voltage terminal.
5	LOUT +	O	Left channel positive audio output.
6	$\overline{\text{SHUTDOWN}}$	I	Places the amplifier in shutdown mode if a TTL logic low is placed on This terminal.
7	BYPASS	I	Tap to voltage divider for internal midsupply bias generator used for analog reference.
8	GND	-	Power ground.
9	VOLUME	I	Terminal for DC volume control. DC voltage range is 0V to 5V.
10	SE/ $\overline{\text{BTL}}$	I	Output MUX control. When this terminal is high, SE outputs are selected. When this terminal is low, BTL outputs are selected.
11	ROUT +	O	Right channel positive audio output.
12	ROUT -	O	Right channel negative audio output.

**3W STEREO AUDIO POWER AMPLIFIER WITH ADVANCED DC VOLUME CONTROL****MAXIMUM RATINGS (Ta = 40~85°C)**

Characteristic	Symbol	Rating	Unit
Supply Voltage, V _{DD} , PV _{DD}	V _{SS}	-0.3 ~ 6	V
Input Voltage	V _I	- 0.3 ~ V _{DD} +0.3	V
Operating free-air temperature range	T _A	- 40 ~ 85	-
Operating junction temperature range	T _J	- 40 ~ 150	°C
Storage temperature range	T _{stg}	- 65 ~ 150	°C
Continuous total power dissipation	-	See Dissipation Rating Table	°C
Lead temperature 1,6 mm (1/16 inch) from case for 10 seconds	-	260	°C

RECOMMENDED OPERATING CONDITION

Characteristic	Symbol	Condition	Min.	Typ.	Max.	Unit
Supply Voltage, V _{DD} , PV _{DD}	V _{SS}	--	4.0	-	5.5	V
High-level input voltage	V _{IH}	SE/BTL	0.8 V _{DD}	-	-	V
	V _{IH}	SHUTDOWN	2.0	-	-	
Low-level input voltage	V _{IL}	SE/BTL	-	-	0.3 V _{DD}	V
	V _{IL}	SHUTDOWN	-	-	0.6	
Operating free-air temperature	T _A	--	-40	-	85	°C



3W STEREO AUDIO POWER AMPLIFIER WITH ADVANCED DC VOLUME CONTROL

ELECTRICAL CHARACTERISTICS (V_{DD} =PV_{DD} = 5.5V, Ta = 25°C unless otherwise noted)

Characteristic	Symbol	Condition	Min.	Typ.	Max.	Unit
Output offset voltage (measured differentially)	V _{OO}	V _{DD} =5.5V,Gain=20dB, SE/BTL=0V	-	-	60	mV
Power supply rejection ratio	PSRR	V _{DD} =PV _{DD} =4.0V to 5.5V	-42	-70	-	dB
High-level input current (SE/BTL,SHUTDOWN,VOLUME)	I _{IH}	V _{DD} =PV _{DD} =5.5V, V _I =V _{DD} =PV _{DD}	-	-	1	uA
Low-level input current(SE/BTL,SHUTDOWN,VOLUME)	I _{IL}	V _{DD} =PV _{DD} =5.5V , V _I =0V	-	-	1	uA
Supply current, no load	I _{DD}	V _{DD} =PV _{DD} =5.5V,SE/BTL=0V, SHUTDOWN=2V	5.5	8.0	10	mA
		V _{DD} =PV _{DD} =5.5V,SE/BTL=5.5V, SHUTDOWN=2V	3.0	5.0	6.0	
Supply current,max power into a 3Ω load	I _{DD}	V _{DD} =5V=PV _{DD} ,SE/BTL=0V, SHUTDOWN=2V,R _L =3Ω, P _O =2W,Stereo	-	1.5	-	ARMS
Supply current,shutdown mode	I _{DD(SD)}	SHUTDOWN=0.0V	-	1	20	uA

OPERATING CHARACTERISTICS

(V_{DD} =PV_{DD} = 5V, R_L = 3Ω, Gain = 6dB, Ta = 25°C unless otherwise noted)

Characteristic	Symbol	Condition	Min.	Typ.	Max.	Unit	
Output Power ⁽¹⁾	P _O	f = 1KHz, R _L =4Ω, BTL Mode , Gain =20 dB	THD+N=1%	-	1.9	-	W
			THD+N=10%	-	2.3	-	
		f = 1KHz, R _L =8Ω, BTL Mode , Gain =20 dB	THD+N=1%	-	1.4	-	
			THD+N=10%	-	1.7	-	
		V _{DD} =5.5V, f = 1KHz, THD+N =10%	-	3	-		
Total harmonic distortion+noise	THD+N	P _O =1W, R _L =8Ω, f=20Hz to 20kHz	-	< 0.6	-	%	
High-level output voltage	V _{OH}	R _L =8Ω, Measured between output and V _{DD}	-	-	600	mV	
Low-level output voltage	V _{OL}	R _L =8Ω, Measured between output and GND	-	-	400	mV	
Bypass voltage(Nominally V _{DD} /2) ⁽²⁾	V _(BYPASS)	Measured at pin 11, No load, V _{DD} =5.5V	2.65	2.75	2.85	V	
Noise output voltage		f= 20 Hz to 20 kHz, Gain=0 dB, C _(BYP) = 1.0 uF		85		μVRMS	

(1) Output power is measured at the output terminals of the IC.

(2) At 4V < V_{DD} < 5.5V the DC bypass voltage is approximately V_{DD}/2

**3W STEREO AUDIO POWER AMPLIFIER WITH ADVANCED DC VOLUME CONTROL**Table 1. DC Volume Control (BTL Mode, $V_{DD}=5V$)

VOLUME		GAIN OF AMPLIFIER (Typ.)
FROM (V)	TO (V)	
0.00	0.23	-85
0.31	0.34	-40
0.42	0.46	-38
0.54	0.56	-36
0.65	0.67	-34
0.76	0.79	-32
0.87	0.90	-30
0.98	1.01	-28
1.10	1.12	-26
1.21	1.24	-24
1.32	1.35	-22
1.43	1.46	-20
1.54	1.57	-18
1.66	1.68	-16
1.77	1.79	-14
1.88	1.91	-12
1.99	2.02	-10
2.10	2.13	-8
2.21	2.24	-6
2.33	2.35	-4
2.44	2.47	-2
2.55	2.57	0
2.67	2.70	2
2.77	2.80	4
2.89	2.92	6
3.00	3.03	8
3.11	3.14	10
3.22	3.26	12
3.33	3.37	14
3.44	3.48	16
3.55	3.60	18
3.67	5.00	20



3W STEREO AUDIO POWER AMPLIFIER WITH ADVANCED DC VOLUME CONTROL

APPLICATION INFORMATION

The figure is schematic diagrams of typical notebook computer application circuits.

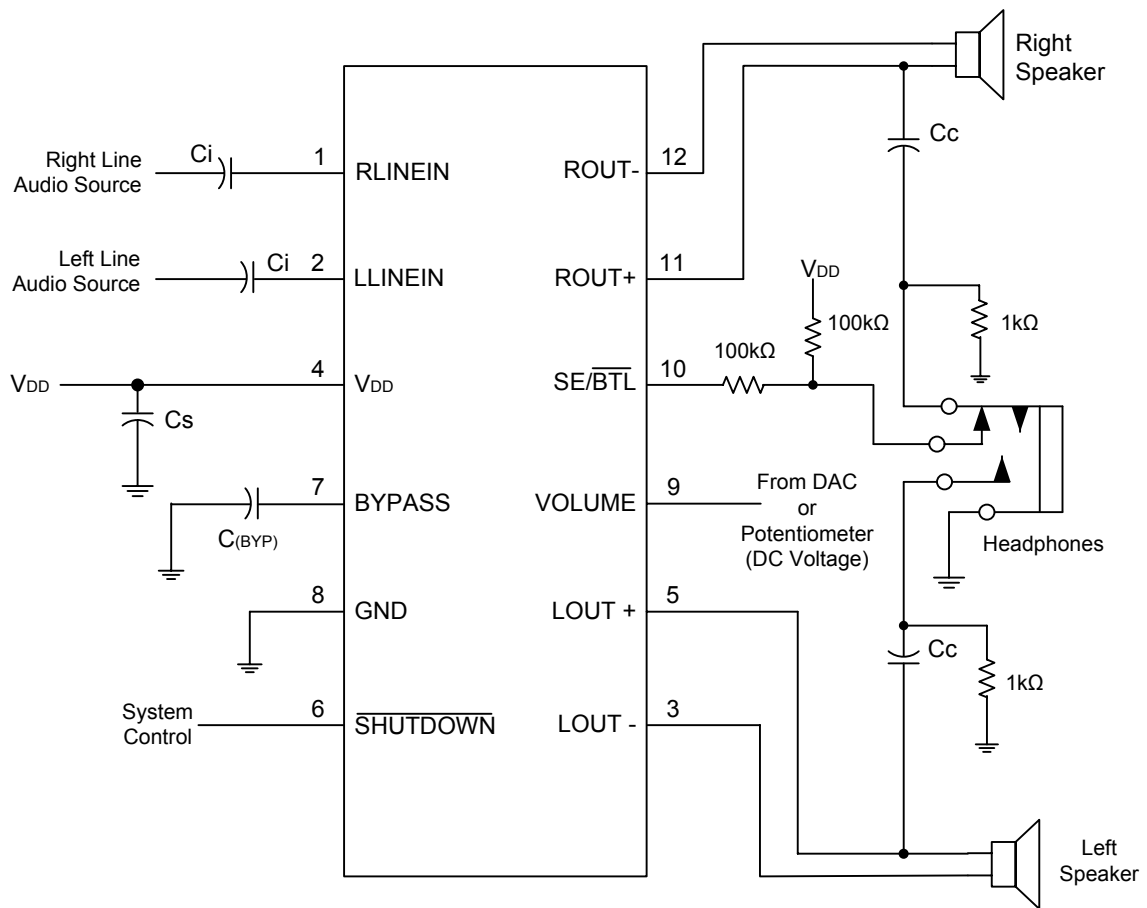
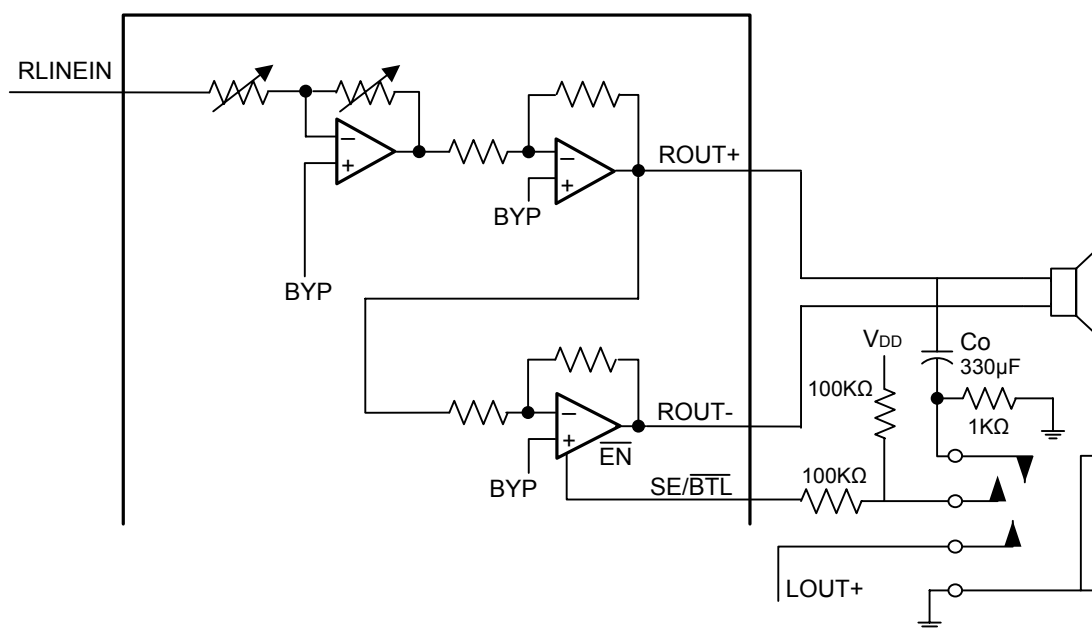

Figure 1. SM7516 Application Circuit Using Single-Ended Inputs

**3W STEREO AUDIO POWER AMPLIFIER WITH ADVANCED DC VOLUME CONTROL****SE/BTL OPERATION**

The ability of the SM7516 to easily switch between BTL and SE modes is one of its most important cost saving features. This feature eliminates the requirement for an additional headphone amplifier in applications where internal stereo speakers are driven in BTL mode but external headphone or speakers must be accommodated. Internal to the SM7516, two separate amplifiers drive OUT+ and OUT-. The SE/BTL input controls the operation of the follower amplifier that drives LOUT- and ROUT-. When SE/BTL is held low, the amplifier is on and the SM7516 is in the BTL mode. When SE/BTL is held high, the OUT- amplifiers are in a high output impedance state, which configures the SM7516 as an SE driver from LOUT+ and ROUT+. I_{DD} is reduced by approximately one-third in SE mode. Control of the SE/BTL input can be from a logic-level CMOS source or, more typically, from a resistor divider network as shown in Figure 2. The trip level for the SE/BTL input can be found in the *recommended operating condition* table.

APPLICATION INFORMATION (continued)**Figure 2. SM7516 Resistor Divider Network Circuit**

Using a 1/8-in. (3,5mm) stereo headphone jack, the control switch is closed when no plug is inserted. When closed the 100kΩ/1kΩ divider pulls the SE/BTL input low. When a plug is inserted, the 1kΩ resistor is disconnected and SE/BTL input is pulled high. When the input goes high, the OUT- amplifier is shut down causing the speaker to mute (open-circuits the speaker). The OUT+ amplifier then drives through the output capacitor (Co) into the headphone jack.

**3W STEREO AUDIO POWER AMPLIFIER WITH ADVANCED DC VOLUME CONTROL****SHUTDOWN MODES**

The SM7516 employs a shutdown mode of operation designed to reduce supply current (I_{DD}) to the absolute minimum level during periods of nonuse for battery-power conservation. The $\overline{\text{SHUTDOWN}}$ input terminal should be held high during normal operation when the amplifier is in use. Pulling $\overline{\text{SHUTDOWN}}$ low causes the outputs to mute and the amplifier to enter a low-current state, $I_{DD}=20\mu\text{A}$. $\overline{\text{SHUTDOWN}}$ should never be left unconnected because amplifier operation would be unpredictable.

VOLUME OPERATION

The VOLUME controls the BTL volume when driving speakers and the SE volume when driving headphones. The pin is controlled with a dc voltage, which should not exceed V_{DD} .

When driving speakers in BTL mode, the VOLUME pin is the only pin that controls the gain. Table 1 shows the gain for the BTL mode. The voltage listed in the table are for $V_{DD}=5\text{V}$. For a different V_{DD} , the values in the table scale linearly. If $V_{DD}=4\text{V}$, multiply all the voltages in the table by $4\text{V}/5\text{V}$ or 0.8.

Some audio systems require that the gain be limited in the single-ended mode to a level that is comfortable for headphone listening. Most volume control devices only have one terminal for setting the gain. For example, if the speaker gain is 20 dB, the gain in the headphone channel is fixed at 14 dB.

Table 1 show a range of voltages for each gain step. There is a gap in the voltage between each gain step. This gap represents the hysteresis about each trip point in the internal comparator. The hysteresis ensures that the gain control is monotonic and does not oscillate from one gain step to another. If a potentiometer is used to adjust the voltage on the control terminals, the gain increases as the potentiometer is turned in one direction and decreases as it is turned back the other direction. The trip point, where the gain actually changes, is different depending on whether the voltage is increased or decreased as a result of the hysteresis about each trip point. The gaps can also be thought of as indeterminate states where the gain could be in the next higher gain step or the lower gain step depending on the direction the voltage is changing. If using a DAC to control the volume, set the volume, set the voltage in the middle of each range to ensure that the desired gain is achieved.

TABLE OF GRAPHS

		FIGURE
THD+N Total harmonic distortion plus noise(BTL)	vs Frequency	3,4,5
	vs Output power	6,7,8
Closed loop response		9,10
Crosstalk	vs Frequency	11,12
PSRR Power supply ripple rejection(BTL)	vs Frequency	13



3W STEREO AUDIO POWER AMPLIFIER WITH ADVANCED DC VOLUME CONTROL

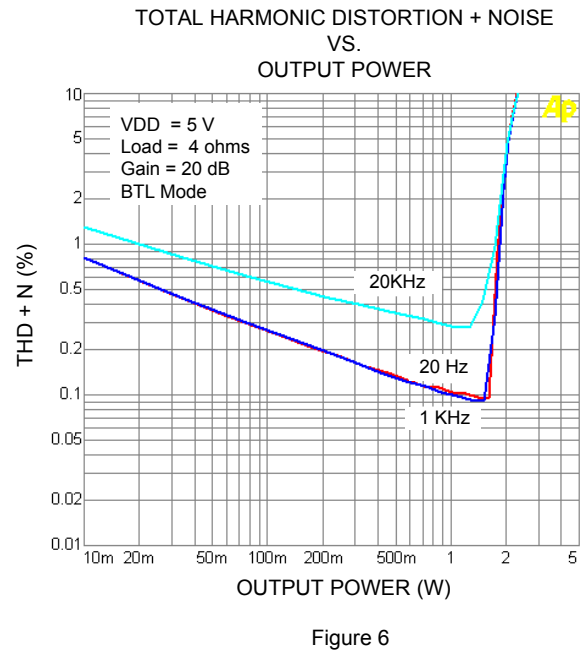
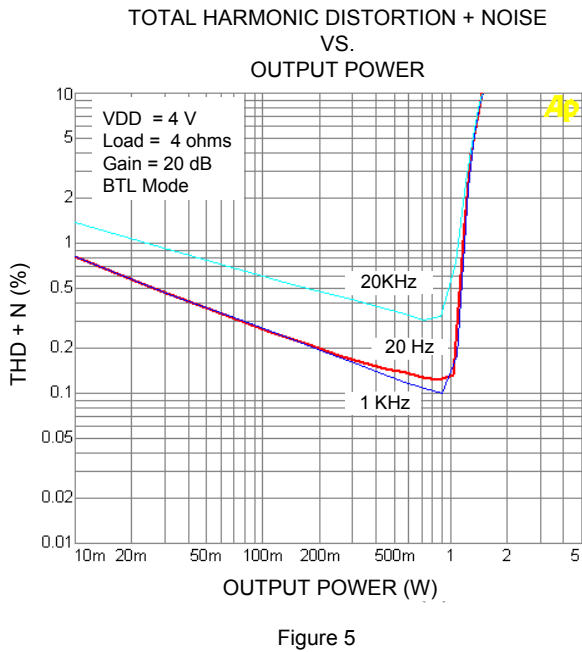
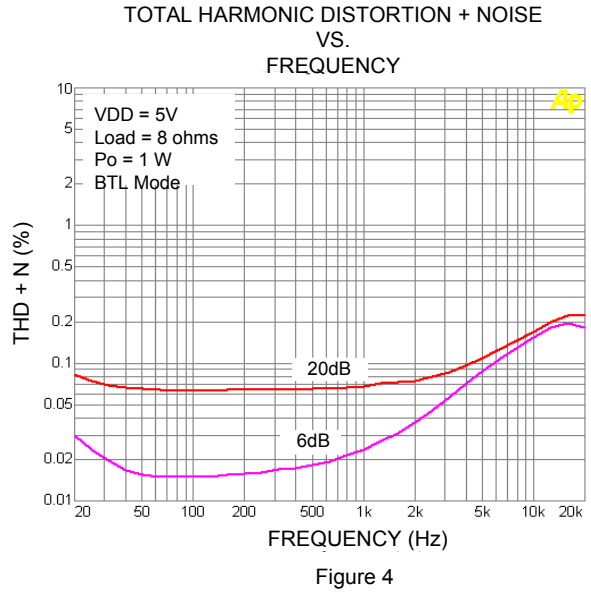
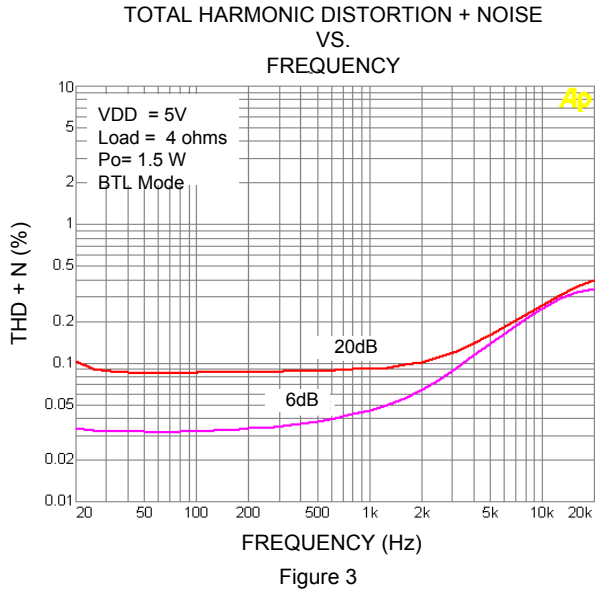



3W STEREO AUDIO POWER AMPLIFIER WITH ADVANCED DC VOLUME CONTROL

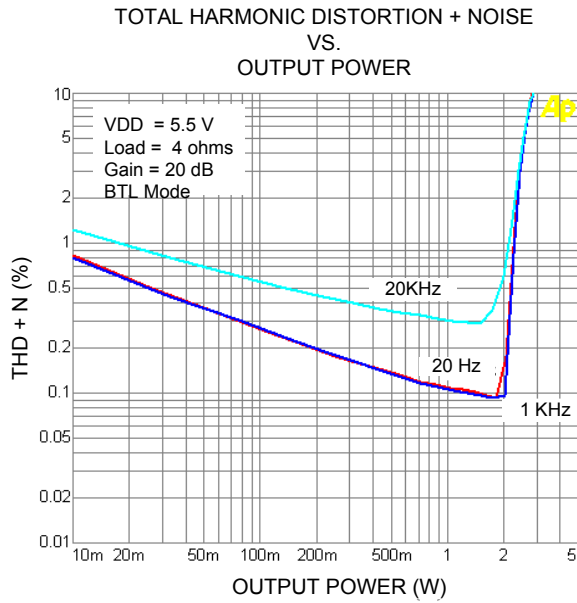

Figure 7

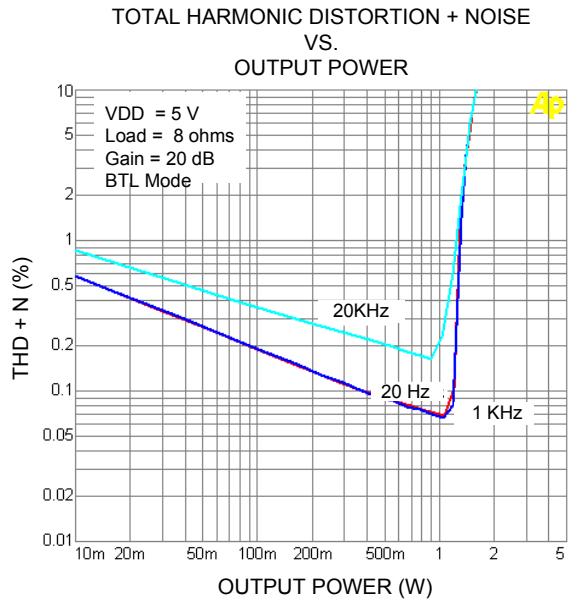

Figure 8

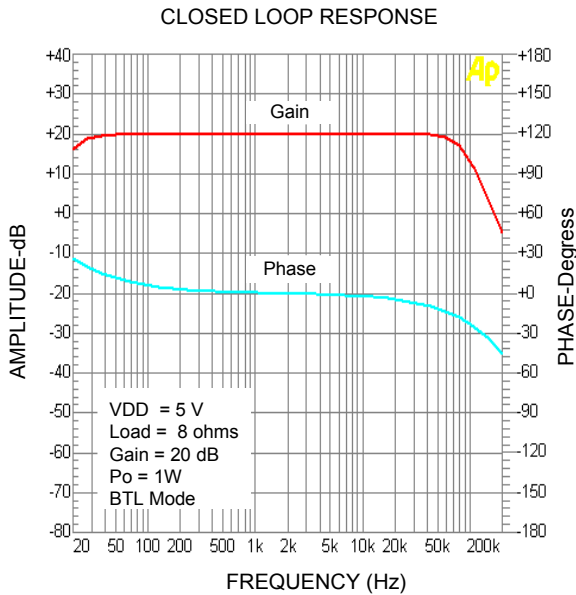

Figure 9

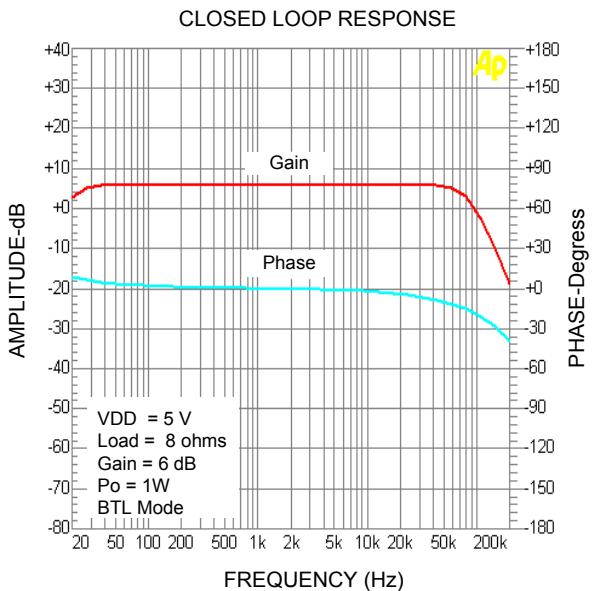

Figure 10



3W STEREO AUDIO POWER AMPLIFIER WITH ADVANCED DC VOLUME CONTROL

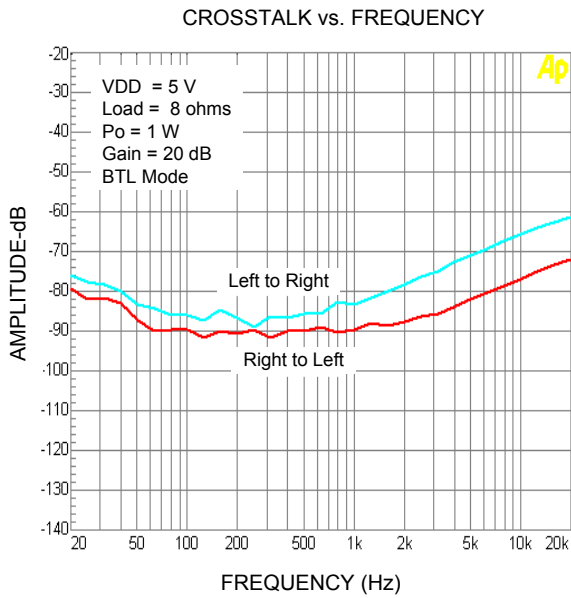

Figure 11

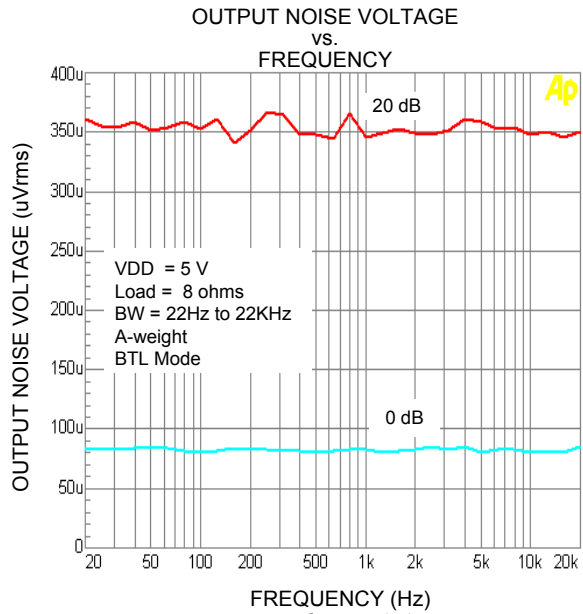

Figure 12



3W STEREO AUDIO POWER AMPLIFIER WITH ADVANCED DC VOLUME CONTROL

PACKAGE OUTLINE

SM7516 12 PIN HDIP

Unit : mm

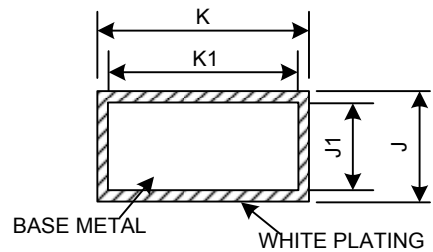
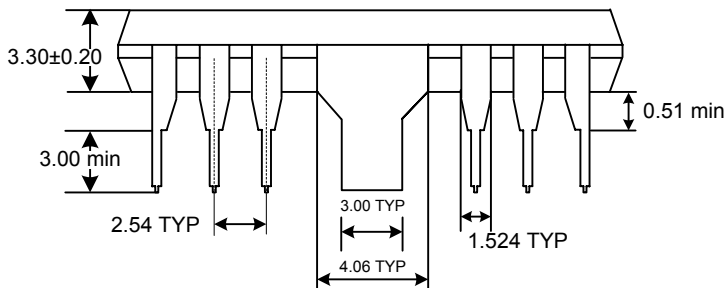
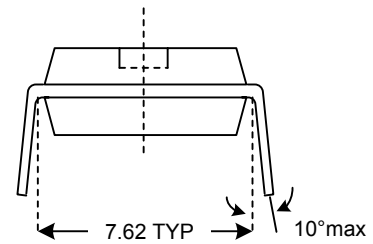
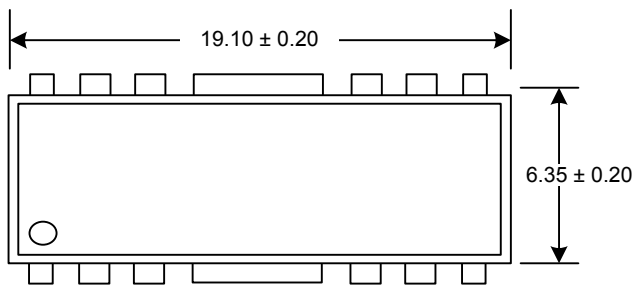

DIM	MILLIMETERS		INCHES	
	MIN	MAX	MIN	MAX
J	0.219	0.339	0.0086	0.0133
J1	0.219	0.289	0.0086	0.0114
K	0.460	0.560	0.0181	0.0220
K1	0.460	0.510	0.0181	0.0201