

Stereo tone control IC for controlling the trebles, basses, balance, volume, physiology, bandwidth of the AF signals by the aid of dc voltages.

It is in compliance with the standards DIN 45500 and IEC 268-3.

The component is especially suited for application in TV stereo devices.

### Features

- Few external components
- Low total harmonic distortion
- Large output signal capability

### Maximum ratings

Supply voltage	$V_{S16}$	0 to 18	V
Reference current	$I_{REF}$	5	mA
Junction temperature	$T_j$	150	°C
Storage temperature range	$T_{stg}$	-40 to 125	°C
Thermal resistance (system-air)	$R_{th SA}$	70	K/W

### Operating range

Supply voltage	$V_{S16}$	8 to 15.75	V
Ambient temperature	$T_A$	0 to 70	°C

**Characteristics** $T_A = 25\text{ }^\circ\text{C}$ 

		min	typ	max	
Current consumption P1...P4 = 22 k $\Omega$	$I_{S+6}$		40	70	mA
Reference voltage	$V_{REF}$	4.5	4.8	5.2	V
Input resistance	$R_{i4,22}$	10	14	18	k $\Omega$
Gain for $V_{24} = V_{REF}^{1)}$ $V_{3,2,23} = V_{REF}/2$	$V_q/V_i$	-4	-1	2	dB
Gain for $V_{24} = 0^{1)}$ any position of S3; S4 open	$V_q/V_i$	-75	-85		dB
Control range balance <sup>1)</sup> $V_{24} = V_{REF}$ ; $V_{2,3} = V_{REF}/2$	$V_{Bmax}$ $V_{Bmin}$	1.5 -20	4 -30	6	dB dB
Bass emphasis <sup>1)</sup> $V_3 = V_{REF}$ ; $f_i = 40$ Hz	$V_{Bmax}$	+9	+12	+16	dB
Bass deemphasis $V_3 = 0$ ; $f_i = 40$ Hz	$V_{Bmin}$	-10	-12		dB
Treble emphasis <sup>1)</sup> $V_2 = V_{REF}$ ; $f_i = 15$ Hz	$V_{Tmax}$	+8.5	+11.5	+14.5	dB
Treble deemphasis $V_2 = 0$ ; $f_i = 15$ kHz	$V_{Tmin}$	-10	-12		dB
Channel separation S4 open	$a_{L-R}$	60			dB
Channel separation (antiphased) for S4 closed	$a_{L-R}$	3	5		dB
Input voltage <sup>1)</sup> $V_{2,3} = \text{any}$	$V_{irms4,22}$			1	V
$V_{2,3} = V_{REF}/2$	$V_{irms4,22}$			3.5	V
Total harmonic distortion <sup>1)</sup> $V_{2,3} = \text{as applied}$ ; $V_{irms} = 1$ V $f_i = 60$ Hz to 12 kHz	THD		0.5	1	%
Total harmonic distortion DIN 45500 <sup>1)</sup> $V_{2,3} = V_{REF}/2$ ; $V_{irms} = 1$ V	THD		0.3	0.6	%
Flutter and wow L-R $f_i = 1$ kHz; $V_q/V_i = 0$ to 40 dB $f_i = 20$ Hz to 20 kHz	$\Delta a_{L-R}$			2	dB
Any regulator	$\Delta a_{L-R}$			4	dB
Disturbance voltage spacing according to DIN 45405 $f_i = 20$ Hz to 20 kHz; $V_{irms} = 1$ V	$a_{S+N/N}$	73	76		dB
Noise voltage with reference to output $f_i = 20$ Hz to 20 kHz $V_i/V_q = 0$ dB <sup>2)</sup> $V_i/V_q = 50$ dB	$V_{n rms}$ $V_{n rms}$		155 10	230 20	$\mu$ V $\mu$ V
Output resistance	$R_{q11,12,14,15}$		0.2	0.3	k $\Omega$
Input current for adjusters $V_{st} = 0$ to $V_{REF}$	$I_{i2,3,23,24}$	-20		0	$\mu$ A
Input current for switches	$I_{i8,18}$	-60	-13	0	$\mu$ A

Electrical data identified with<sup>1)</sup> is only applicable at  $V_S = 15$  V +5% and  $V_{rms} = 1$  V. Furthermore, the maximum input voltage decreases in accordance with lower supply voltages.

<sup>2)</sup> Inputs terminated with 1 k $\Omega$ .

**Characteristics**

$V_S = 15\text{ V}$ ;  $T_A = 25^\circ\text{C}$

Level of the switches

H or open

Downcontrol diff. of the AF outputs

S3 open

$$V_{24} = 3/4 V_{REF}$$

Disturbance voltage at the output (DIN 45405)

$$f_i = 20\text{ Hz to } 20\text{ kHz}; V_i/V_q = -20\text{ dB}$$

Noise voltage CCIR; (DIN 45405)

$$V_{24} = V_{REF}; V_2 = 0$$

Amplitude variation trebles,

basses in middle position

$$V_{23} = V_{REF}/2; f_i = 40\text{ Hz, } 1\text{ kHz, } 15\text{ kHz}$$

Output voltage deviation

	min	typ	max	
$V_{SWH}$	$V_{REF} - 1$		$V_{REF}$	V
$V_{SWL}$	0		1	V
$\Delta V_q$	14	21	28	dB
$V_d$		35	50	$\mu\text{V}$
$V_{npp}$			650	$\mu\text{V}$
		$\pm 0.5$	$\pm 1.5$	dB
$\Delta V_{QLnpp}$			300	mV

**Pin description**

Pin	Function
1	Reference voltage
2	Treble control input
3	Bass control input
4	Input right
5	Cutoff frequency bass
6	Right
7	Cutoff frequency treble right
8	Switch input physiology
9	Start frequency base width right
10	GND
11	Output right
12	Output right
13	Blockage
14	Output left
15	Output left
16	Supply voltage
17	Start frequency base width left
18	Switch input base width
19	Cutoff frequency treble left
20	Cutoff frequency bass
21	Left
22	Input left
23	Balance control input
24	Volume control input

---

### Circuit description

The component includes 5 operational amplifiers per stereo channel. The operational amplifiers are equipped with either dc voltage controlled attenuators or switches. By applying potentiometers to the externally connected capacitors, the emphasis or deemphasis of low or high frequencies can be controlled. The base width can be switched by the subsequent stage. This stage will not respond during open switch status. However, with a closed switch, antiphased crosstalk of estimated 66% occurs at a frequency of approx. 300 Hz, which has been determined by one of the external capacitors. To ensure that the base width effect remains independent of the balance setting, balance control is performed subsequently to the base width control. The volume control is comprised of 2 stages. The identical configuration and parallel layout of these stages, designed to affect base width, balance, and volume, provide at the same time simultaneous electrical and thermal tracking. In the volume stage the rising incline of the volume characteristic can be switched to lower values. Both outputs have been equipped with a resistor capacitor network for physiologically correct amplification adjustment. Frequency independent (linear) amplification adjustment is obtained during the identical rise of the volume characteristic at both outputs.

In order to prevent disruptive clicking noises, the delay switch releases the AF output voltage subsequently to the supply voltage and voltage stabilization in the component.

## Pin description

Pin	Function
1	Reference voltage, typ. 4.8 V
2	Adjusting input for treble control. Adjusting range 0 V to $V_1$ . PNP transistor input, the base current flows out.
3	Adjusting input for bass control. Features like pin 2.
4	Signal input right. The dc socket is approx. $V_{16}/2 - 0.7$ V. The input resistance is frequency-dependent (minimum at high frequencies) and dependent on the position of the bass control (minimum at full low-frequency peaking)
5, 6	Connections for external capacitance of the right bass control $f_{3dB} \approx 1/C_{5, 6}$ .
7	Connection for ext. capacitance of the right treble control. $f_{3dB} \approx 1/C_7$
8	Switching input for physiology. Internal pull-up resistance against $V_1$ is available. Physiology "ON" for not connected pin or $V_8 \geq V_1 - 1$ V.
9	Connection for network of the stereo basewidth enlargement. Crosstalk $\approx 1/R_g$ .
	$f_{3dB} = \frac{1}{2\pi C_9 (R_g + 3 \text{ k}\Omega)}$
10	GND
11, 12	AF outputs right. (NPN emitter follower). At physiology "OFF" both outputs supply the same level. At physiology "ON" a level difference dependent on the volume adjustment occurs. (Pin 11 is on a higher level).
13	Blocking for internal dc operating points. The capacitance determines also the duration of the switch-on delay after applying $V_{16}$ .
14, 15	AF outputs left. The function corresponds to the function of pin 11, 12. (pin 11 = pin 15, pin 12 = pin 14)
16	Supply voltage
17	Like pin 9, left
18	Switching input for basewidth. Internal pull-up resistance against $V_1$ is available. Basewidth "OFF" for not connected pin or $V_{18} \geq V_1 - 1$ V.
19	Like pin 7, left
20, 21	Like pin 5, 6, left
22	Input left, features like pin 4.
23	Adjusting input for balance control. Features like pin 2.
24	Adjusting input for volume control. Features like pin 2.

Block diagram

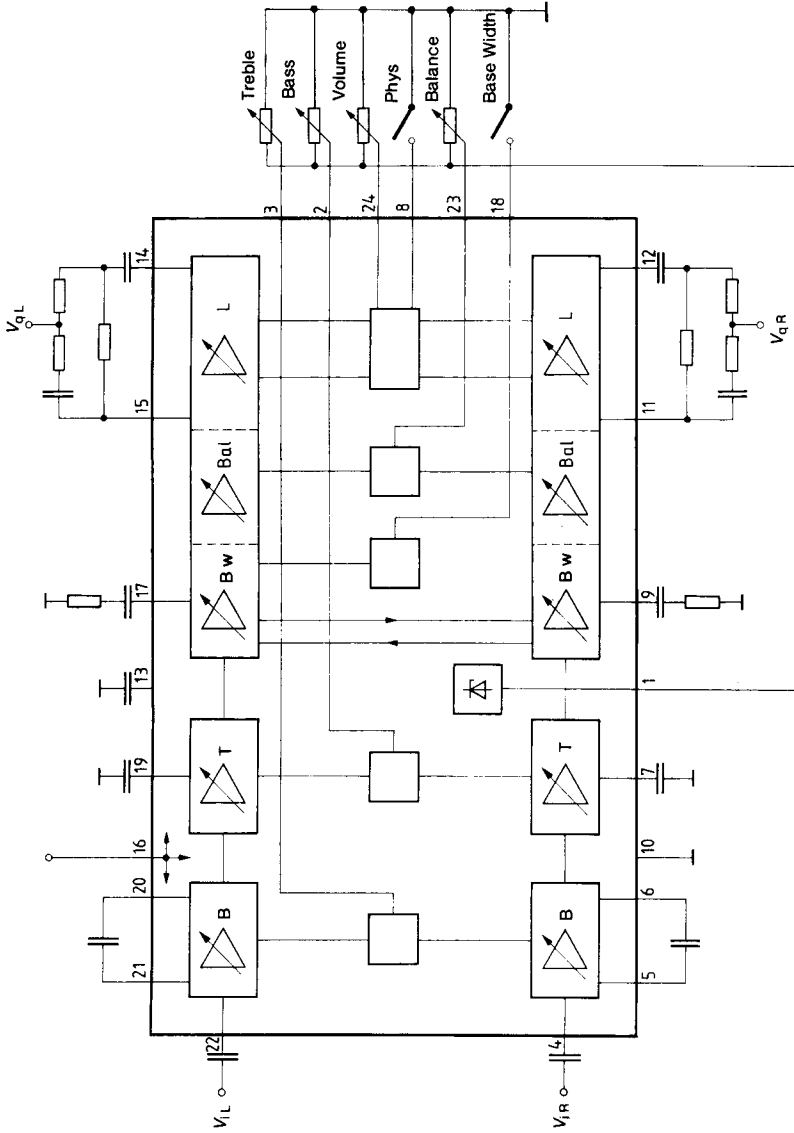

Measurement circuit

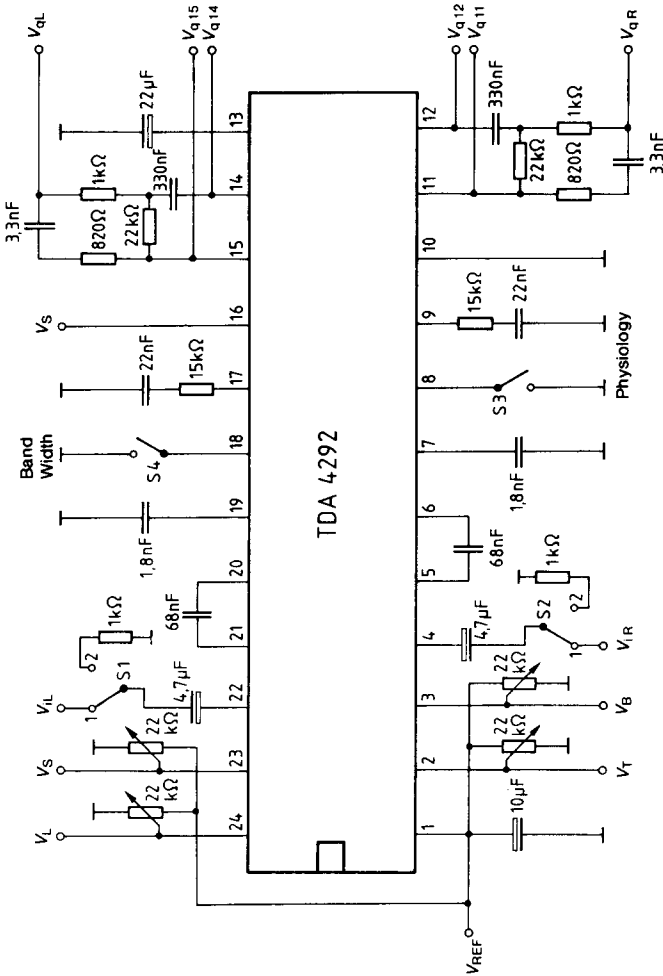

S1, S2 in position 2 during noise measurement

## Application circuit

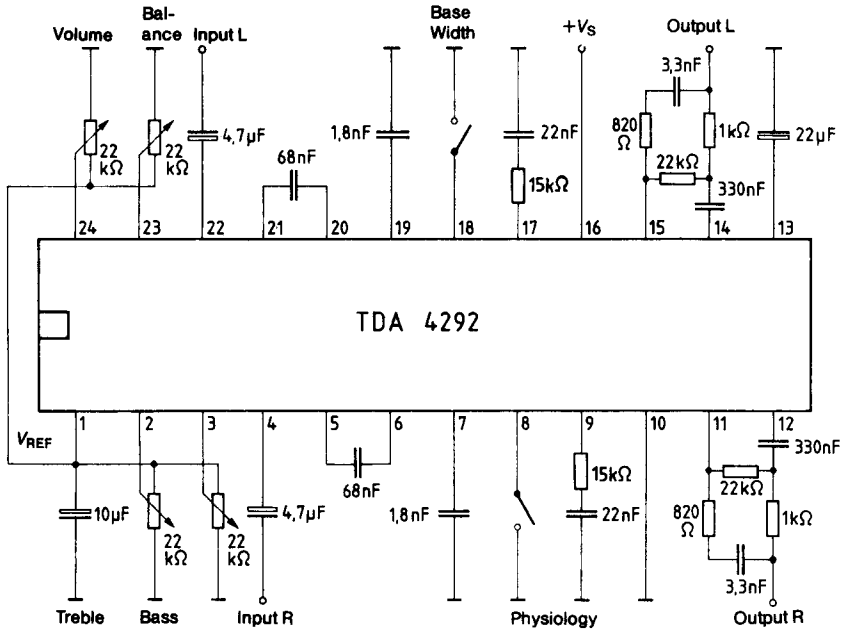



**Bass and treble control**

S3 closed, S4 open

$V_S = 15\text{ V}; V_{\text{irms}} = 1\text{ V}$

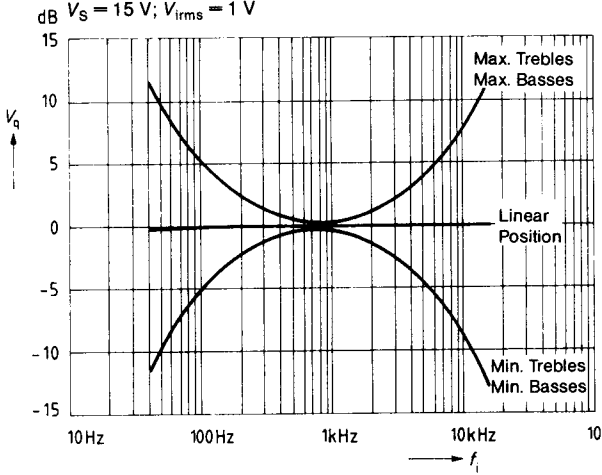

**Bass and treble control**

S3 closed, S4 open

$V_S = 15\text{ V}; V_{\text{irms}} = 1\text{ V}$

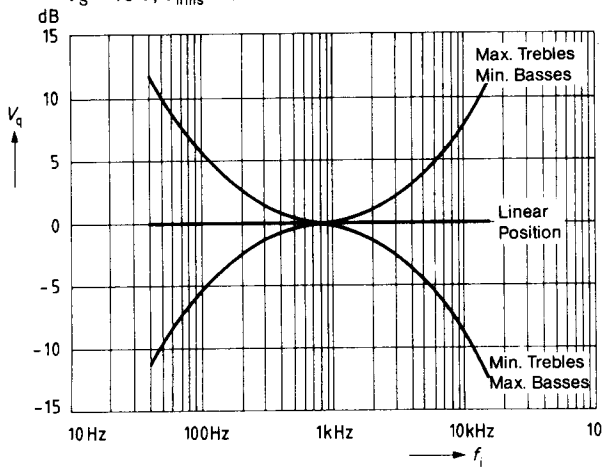

**Treble control**

S3 closed, S4 open

$V_S = 15\text{ V}$ ;  $V_{\text{irms}} = 1\text{ V}$

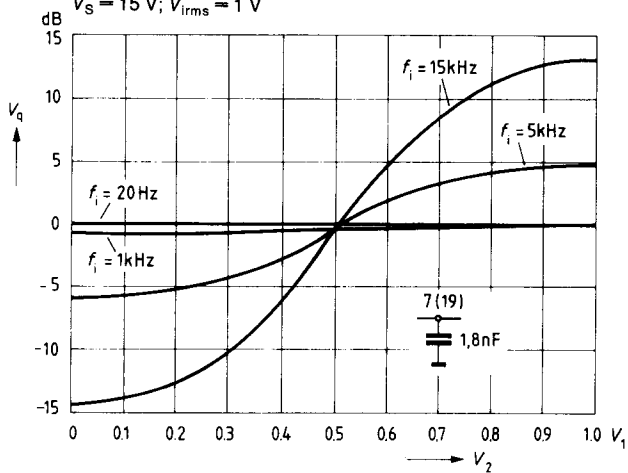

**Bass control**

S3 closed, S4 open

$V_S = 15\text{ V}$ ;  $V_{\text{irms}} = 1\text{ V}$

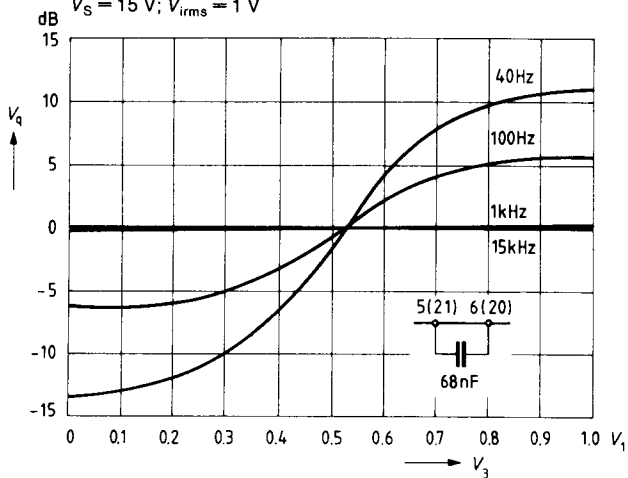

**Physiological volume control**

$V_S = 15\text{ V}; V_{\text{irms}} = 1\text{ V}$

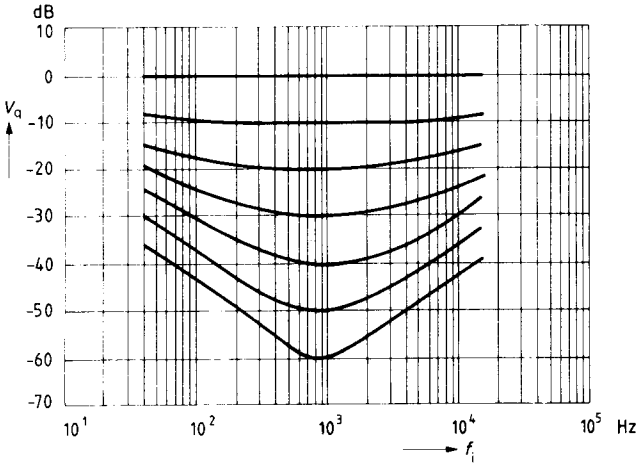

**Volume control with physiology**

$V_S = 15\text{ V}; V_{\text{irms}} = 1\text{ V}$

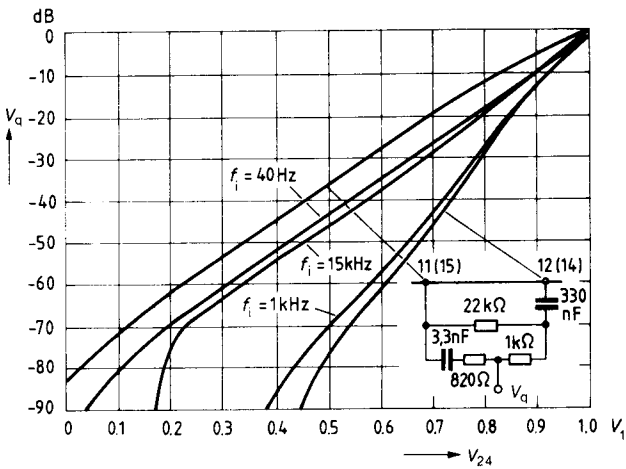

**Balance**

S3 closed, S4 open

$V_S = 15\text{ V}$ ;  $V_{\text{irms}} = 1\text{ V } 0\text{ dB}$

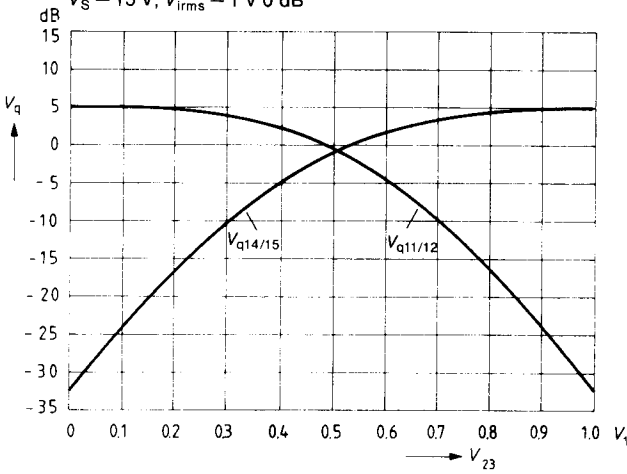

**Base width**

$V_S = 15\text{ V}$ ;  $V_{\text{irms}} = 1\text{ V}$

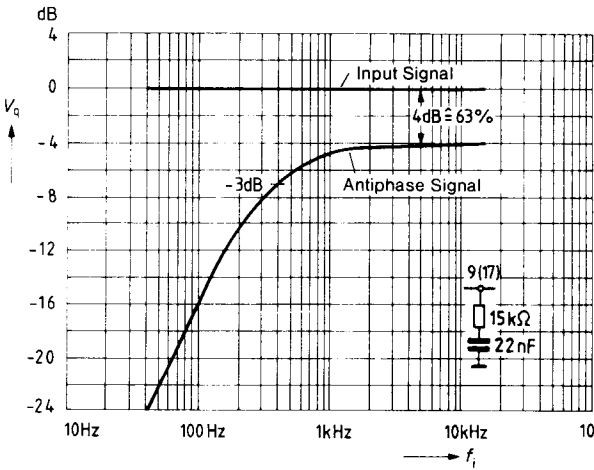

**Disturbance voltage spacing**

S3 closed, S4 open

$V_s = 15\text{ V}$ ;  $V_{i\text{rms}} = 300\text{ mV}$

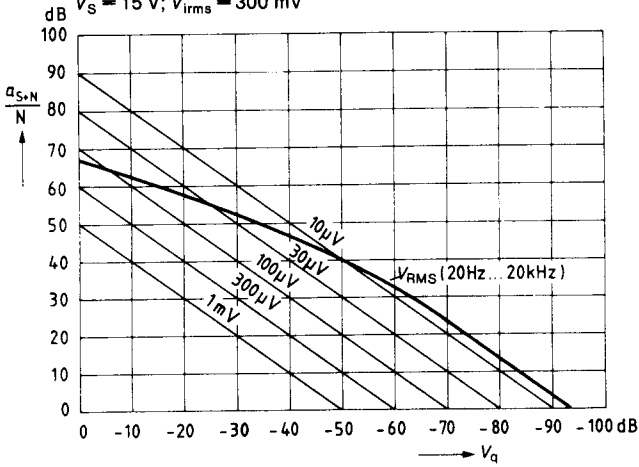

### Base width circuits

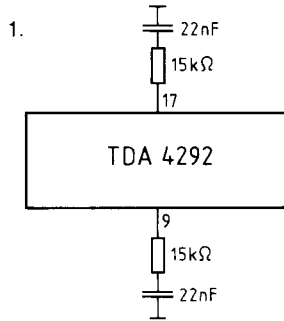

#### a) Stereo reception

i.e. normal linear frequency response and stereo sensation with closely spaced loudspeakers.

With the base width ON the base-width effect has a time constant of  $22 \text{ nF}/15 \text{ k}\Omega$ , i.e. the subjective spacing between the loudspeakers is greater.

#### b) Mono reception (with base width ON)

Normal linear frequency response and mono sensation.

With the base width ON there is a deemphasis of approx.  $-5 \text{ dB}$  from about  $300 \text{ Hz}$  onwards. This causes slight treble deemphasis and the acoustic impression is duller and somewhat quieter.

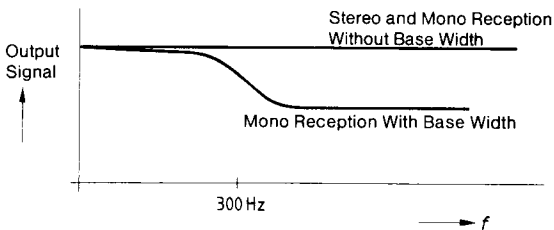

Effect: At mono signal: trebles approx.  $-5 \text{ dB}$   
At stereo signal: cross-talk over  $300 \text{ Hz}$

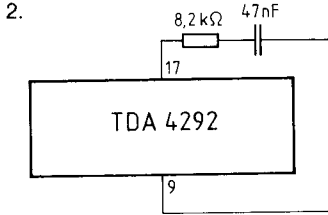

a) **Stereo reception and base width ON**

The trebles are emphasized from 300 Hz onwards by up to +5 dB (time constant 8.2 kΩ and 4 nF), i.e. with the base width switched on there is simultaneously a slight change in the timbre of the acoustic impression.

b) **Mono reception and base width ON**

Switching on the base width produces no change at all in the acoustic impression.

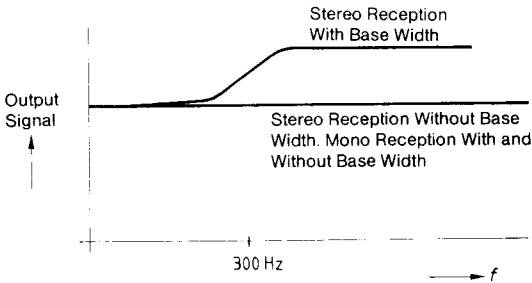

Effect: At mono signal: no influence  
 At stereo signal: trebles approx. +5 dB

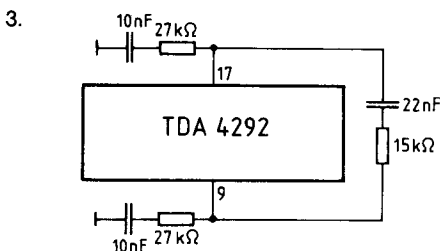

a) **Stereo reception and base width ON**

From 300 Hz onwards emphasis of the trebles by +2.5 dB with the corresponding time constants.

b) **Mono reception and base width ON**

From about 300 Hz onwards deemphasis by about -2.5 dB.

With the corresponding time constants this produces a slight loss of treble and makes the acoustic impression darker and quieter.

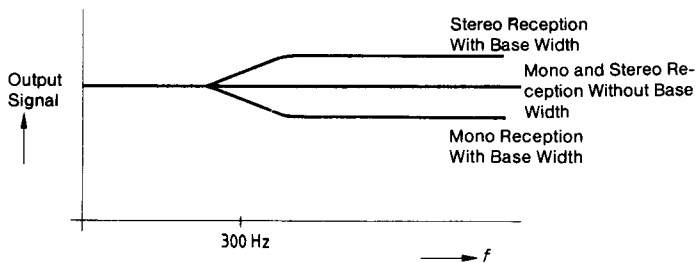

Effect: At mono signal: trebles approx. -2.5 dB  
At stereo signal: trebles approx. +2.5 dB



**Physiological volume control (loudness) versus frequency and capacitance values  $C_x$   $G_V$  deviations for different capacitances ( $R_L$  at output 1 M $\Omega$ ).**

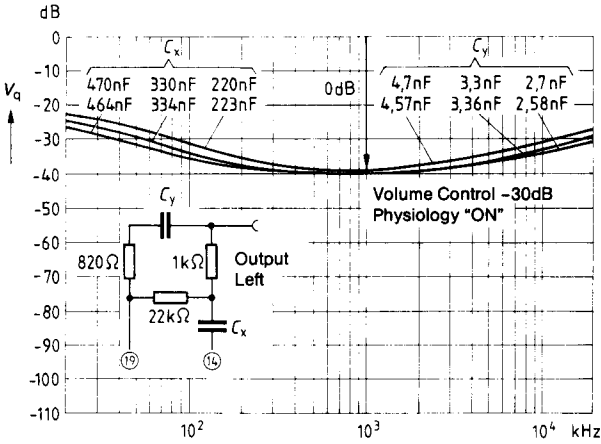

**Physiological volume control (loudness) versus frequency and load resistance  $R$**   
 Output loaded with  $R$  ( $C_y = 3.3$  nF;  $C_x = 680$  nF).

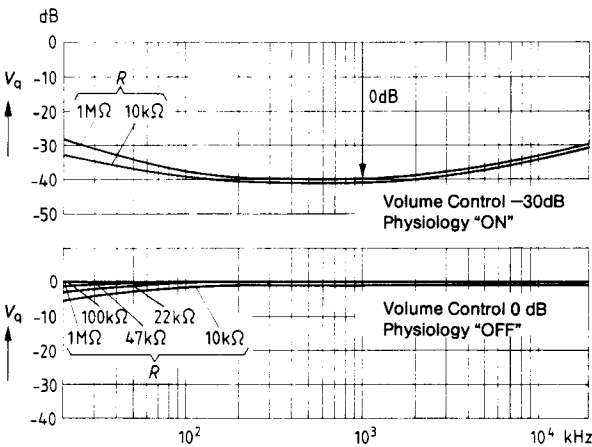

**Bass and treble control versus frequency**  
 **$G_v$  deviations for different capacitances (load at output 1 M $\Omega$ )**

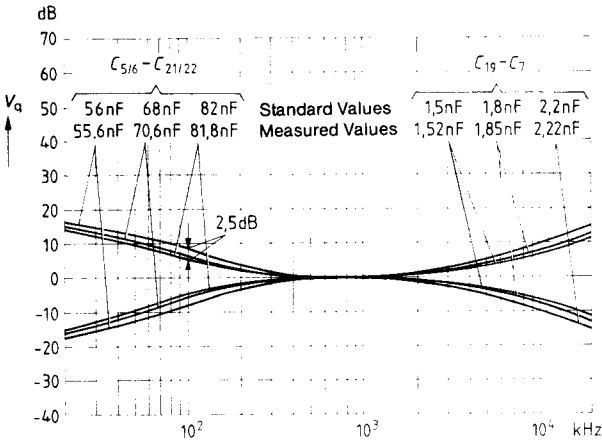

### Alteration of frequency response through component tolerances

#### ● Bass control

Capacitor	Pin 21/20 – 5/6	$C = 68 \text{ nF}$
68 nF – 20%	$G_V = +1.5 \text{ dB}$	
68 nF	$G_V = 0 \text{ dB}$	$f = 100 \text{ Hz}$
68 nF + 20%	$G_V = -1 \text{ dB}$	

#### ● Treble control

Capacitor	Pin 19 – 7	$C = 1.8 \text{ nF}$
1.8 nF – 20%	$G_V = -1 \text{ dB}$	
1.8 nF	$G_V = 0 \text{ dB}$	$f = 10 \text{ kHz}$
1.8 nF + 20%	$G_V = +1.5 \text{ dB}$	

#### ● Physiology network

Capacitor for bass emphasis		$C_x = 330 \text{ nF}$
330 nF – 30%	$G_V = -3 \text{ dB}$	
330 nF	$G_V = 0 \text{ dB}$	$f = 100 \text{ Hz}$
330 nF + 40%	$G_V = +2 \text{ dB}$	
Capacitor for treble emphasis		$C_y = 3.3 \text{ nF}$
3.3 nF – 20%	$G_V = 1 \text{ dB}$	
3.3 nF	$G_V = 0 \text{ dB}$	$f = 10 \text{ kHz}$
3.3 nF + 40%	$G_V = +2 \text{ dB}$	

#### ● Terminating resistor

$R_A = 10 \text{ k}\Omega$	$G_V = -5 \text{ dB}$	
$R_A = 22 \text{ k}\Omega$	$G_V = -2.5 \text{ dB}$	
$R_A = 47 \text{ k}\Omega$	$G_V = -1 \text{ dB}$	$f = 20 \text{ Hz}$
$R_A = 100 \text{ k}\Omega$	$G_V = -0.5 \text{ dB}$	
$R_A = 1 \text{ M}\Omega$	$G_V = 0 \text{ dB}$	