



# 65V, 400mA, Low-Quiescent-Current Linear Regulator with Adjustable Reset Delay

MAX5087

## General Description

The MAX5087 high-voltage linear regulator operates from an input voltage of 6.5V to 65V and delivers up to 400mA of output current. The device consumes only 70µA of quiescent current with no load and 11µA in shutdown. The device includes a SET input, that when connected to ground, selects a preset output voltage of 3.3V (MAX5087A) or 5.0V (MAX5087B). Alternatively, the output voltage can be adjusted from 2.5V to 11V by simply connecting SET to the regulator's output through a resistive divider network. The MAX5087 also provides an open-drain, active-low microprocessor (µP) reset output that asserts when the regulator output drops below the preset output voltage threshold. An external capacitor programs the reset timeout period. Other features include an enable input, thermal shutdown, and short-circuit protection.

The MAX5087 operates over the automotive temperature range of -40°C to +125°C and is available in a 16-pin or a 56-pin TQFN thermally enhanced package.

## Applications

- Automotive
- Industrial
- Home Security/Safety
- Networking

## Features

- ◆ Wide Operating Input Voltage Range (6.5V to 65V)
- ◆ Thermally Enhanced Package Dissipates  
2.6W at T<sub>A</sub> = +70°C (16-Pin TQFN)  
3.8W at T<sub>A</sub> = +70°C (56-Pin TQFN)
- ◆ Guaranteed 400mA Output Current
- ◆ 70µA Quiescent Supply Current
- ◆ Preset 3.3V, 5.0V, or Adjustable 2.5V to 11V Output Voltage
- ◆ Remote Load Sense Capability
- ◆ Enable Input
- ◆ Integrated µP Reset Circuit with Programmable Timeout Period
- ◆ Thermal and Short-Circuit Protection
- ◆ -40°C to +125°C Operating Temperature Range

## Ordering Information

PART	PIN-PACKAGE	PKG CODE	OUTPUT VOLTAGE (V)
MAX5087AATE+	16 TQFN-EP*	T1655-2	3.3
MAX5087BATE+	16 TQFN-EP*	T1655-2	5.0
MAX5087AATN+	56 TQFN-EP*	T5688-3	3.3
MAX5087BATN+	56 TQFN-EP*	T5688-3	5.0

**Note:** All devices are specified over the -40°C to +125°C operating temperature range.

\*EP = Exposed paddle.

+Denotes lead-free package.

## Pin Configurations

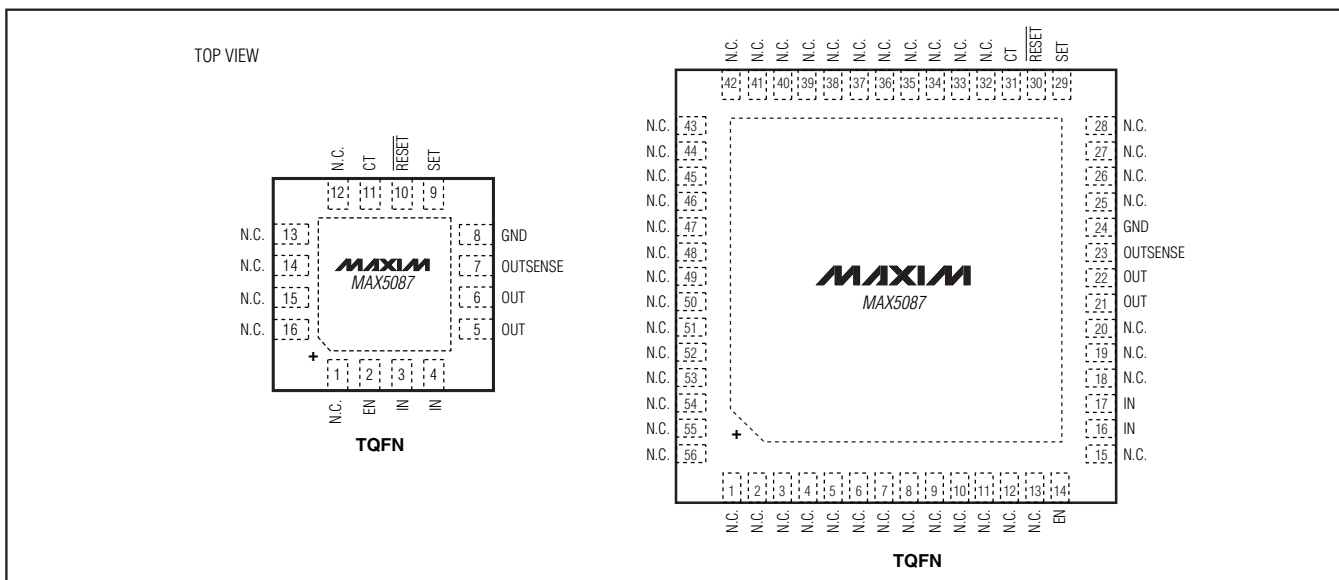

For pricing, delivery, and ordering information, please contact Maxim/Dallas Direct! at 1-888-629-4642, or visit Maxim's website at [www.maxim-ic.com](http://www.maxim-ic.com).

# 65V, 400mA, Low-Quiescent-Current Linear Regulator with Adjustable Reset Delay

## ABSOLUTE MAXIMUM RATINGS

IN to GND (do not exceed package power dissipation)	-0.3V to +70V
IN to GND ( $T \leq 300\text{ms}$ , $I_{\text{OUT}} \leq 250\text{mA}$ )	-0.3V to +42V
EN to GND	-0.3V to +70V
CT, RESET, SET, OUT, OUTSENSE to GND	-0.3V to +12V
IN to OUT	-0.3V to +70V
Short-Circuit Duration ( $V_{\text{IN}} \leq 14\text{V}$ )	Continuous
Maximum Current into Any Pin (Except IN, OUT)	$\pm 20\text{mA}$
Continuous Power Dissipation ( $T_A = +70^\circ\text{C}$ )	
16-Pin TQFN (derate $33.3\text{mW}/^\circ\text{C}$ above $+70^\circ\text{C}$ )	2666mW*
56-Pin TQFN (derate $47.6\text{mW}/^\circ\text{C}$ above $+70^\circ\text{C}$ )	3809mW*

Thermal Resistance:	
$\theta_{\text{JA}}$ , 16-Pin TQFN	$30.0^\circ\text{C}/\text{W}$
$\theta_{\text{JC}}$ , 16-Pin TQFN	$1.7^\circ\text{C}/\text{W}$
$\theta_{\text{JA}}$ , 56-Pin TQFN	$21.0^\circ\text{C}/\text{W}$
$\theta_{\text{JC}}$ , 56-Pin TQFN	$0.6^\circ\text{C}/\text{W}$
Operating Temperature Range	$-40^\circ\text{C}$ to $+125^\circ\text{C}$
Junction Temperature	$+150^\circ\text{C}$
Storage Temperature Range	$-60^\circ\text{C}$ to $+150^\circ\text{C}$
Lead Temperature (soldering, 10s)	$+300^\circ\text{C}$

\*As per JEDEC51 standard (multilayer board).

Stresses beyond those listed under "Absolute Maximum Ratings" may cause permanent damage to the device. These are stress ratings only, and functional operation of the device at these or any other conditions beyond those indicated in the operational sections of the specifications is not implied. Exposure to absolute maximum rating conditions for extended periods may affect device reliability.

## ELECTRICAL CHARACTERISTICS

( $V_{\text{IN}} = 14\text{V}$ ,  $I_{\text{OUT}} = 1\text{mA}$ ,  $C_{\text{IN}} = 10\mu\text{F}$ ,  $C_{\text{OUT}} = 15\mu\text{F}$ ,  $V_{\text{EN}} = 2.4\text{V}$ ,  $10\text{k}\Omega$  from RESET to OUT,  $T_A = T_J = -40^\circ\text{C}$  to  $+125^\circ\text{C}$ , unless otherwise noted. Typical specifications are at  $T_A = +25^\circ\text{C}$ .) (Note 1)

PARAMETER	SYMBOL	CONDITIONS	MIN	TYP	MAX	UNITS	
Input Voltage Range	$V_{\text{IN}}$	$V_{\text{IN}} \geq V_{\text{OUT}} + 1.5\text{V}$	6.5		65.0	V	
Supply Current	$I_{\text{Q}}$	Measured at GND, SET = GND		70	150	$\mu\text{A}$	
		$I_{\text{OUT}} = 0$					
		$I_{\text{OUT}} = 400\text{mA}$		5300			
Shutdown Supply Current	$I_{\text{SHDN}}$	$V_{\text{EN}} \leq 0.4\text{V}$		11	21	$\mu\text{A}$	
<b>REGULATOR</b>							
Guaranteed Output Current	$I_{\text{OUT}}$	$V_{\text{IN}} = 6.5\text{V}$ , $V_{\text{OUT}} = 5.0\text{V}$	400			mA	
Output Voltage (Note 2)	$V_{\text{OUT}}$	SET = GND, 5V version	$6.5\text{V} \leq V_{\text{IN}} \leq 25\text{V}$ , $5\text{mA} \leq I_{\text{OUT}} \leq 400\text{mA}$	4.87	5	5.13	V
			$6.5\text{V} \leq V_{\text{IN}} \leq 65\text{V}$ , $5\text{mA} \leq I_{\text{OUT}} \leq 100\text{mA}$	4.850	5	5.150	
		SET = GND, 3.3V version	$6.5\text{V} \leq V_{\text{IN}} \leq 25\text{V}$ , $5\text{mA} \leq I_{\text{OUT}} \leq 400\text{mA}$	3.208	3.3	3.392	
			$6.5\text{V} \leq V_{\text{IN}} \leq 65\text{V}$ , $5\text{mA} \leq I_{\text{OUT}} \leq 100\text{mA}$	3.208	3.3	3.392	
				$I_{\text{OUT}} = 5\text{mA}$ , adjustable range	2.5		
Dropout Voltage	$\Delta V_{\text{DO}}$	$I_{\text{OUT}} = 400\text{mA}$ , $V_{\text{OUT}} = 5\text{V}$ (Note 3)		0.9	2.2	V	
Startup Response Time		Rising edge of $V_{\text{IN}}$ to $V_{\text{OUT}}$ , $R_{\text{L}} = 500\Omega$ , SET = GND (Note 4)		400		$\mu\text{s}$	
Line Regulation	$\Delta V_{\text{OUT}} / \Delta V_{\text{IN}}$	$8\text{V} \leq V_{\text{IN}} \leq 65\text{V}$	5V version	-1	+1	mV/V	
			3.3V version	-0.5	+0.5		
Enable Voltage	$V_{\text{EN}}$	$V_{\text{EN}} = \text{high}$ , regulator on	2.4			V	
		$V_{\text{EN}} = \text{low}$ , regulator off			0.4		

# 65V, 400mA, Low-Quiescent-Current Linear Regulator with Adjustable Reset Delay

MAX5087

## ELECTRICAL CHARACTERISTICS (continued)

( $V_{IN} = 14V$ ,  $I_{OUT} = 1mA$ ,  $C_{IN} = 10\mu F$ ,  $C_{OUT} = 15\mu F$ ,  $V_{EN} = 2.4V$ ,  $10k\Omega$  from  $\overline{RESET}$  to OUT,  $T_A = T_J = -40^\circ C$  to  $+125^\circ C$ , unless otherwise noted. Typical specifications are at  $T_A = +25^\circ C$ .) (Note 1)

PARAMETER	SYMBOL	CONDITIONS	MIN	TYP	MAX	UNITS
Enable Input Current	$I_{EN}$	$V_{EN} = 2.4V$		0.35		$\mu A$
		$V_{EN} = 14V$		3.4		
SET Reference Voltage	$V_{SET}$		1.200	1.235	1.260	V
SET Input Leakage Current	$I_{SET}$		-100	+0.5	+100	nA
Load Regulation	$\frac{\Delta V_{OUT}}{\Delta I_{OUT}}$	$I_{OUT} = 1mA$ to 400mA (Note 2)		0.1	0.35	$\Omega$
Power-Supply Rejection Ratio	PSRR	$I_{OUT} = 10mA$ , $f = 100Hz$ , 500mV <sub>P-P</sub> , $V_{OUT} = 5V$		70		dB
Short-Circuit Current	$I_{SC}$	$V_{IN} < 14V$ (Note 5)		640		mA
Thermal Shutdown Temperature	$T_{J(SHDN)}$			175		$^\circ C$
Thermal Shutdown Hysteresis	$\Delta T_{J(SHDN)}$			25		$^\circ C$
$\overline{RESET}$ Voltage Threshold	$V_{\overline{RESET}}$		89	92	94	% $V_{OUT}$
$\overline{RESET}$ Threshold Hysteresis	$V_{RHYST}$			2		% $V_{OUT}$
$\overline{RESET}$ Output Low Voltage	$V_{RL}$	$I_{SINK} = 1mA$			0.4	V
$\overline{RESET}$ Output Leakage Current	$I_{RH}$	$V_{\overline{RESET}} = 5V$			1	$\mu A$
$\overline{RESET}$ Output Minimum Timeout Period		When $V_{OUT}$ reaches $\overline{RESET}$ threshold, $C_{CT} = Open$		15		$\mu s$
ENABLE to $\overline{RESET}$ Minimum Timeout Period		When EN goes high, $C_{CT} = open$		170		$\mu s$
Delay Comparator Threshold (Rising)			1.196	1.230	1.264	V
Delay Comparator Threshold Hysteresis				100		mV
CT Charge Current			1	2	4	$\mu A$
CT Discharge Current				5		mA

**Note 1:** Limits at  $-40^\circ C$  are guaranteed by design.

**Note 2:** Output voltage is tested using a pulsed load current of less than 50ms duration.

**Note 3:** Dropout voltage is defined as  $(V_{IN} - V_{OUT})$  when  $V_{OUT}$  is 100mV below the value of  $V_{OUT}$  for  $V_{IN} = V_{OUT} + 3V$ .

**Note 4:** Startup time measured from 50% of  $V_{IN}$  to 90% of  $V_{OUT}$ .

**Note 5:** Continuous short-circuit protection for  $V_{IN} > 14V$  not guaranteed.

# 65V, 40mA, Low-Quiescent-Current Linear Regulator with Adjustable Reset Delay

## Typical Operating Characteristics

( $V_{IN} = V_{EN} = 14V$ ,  $C_{IN} = 10\mu F$ ,  $C_{OUT} = 15\mu F$ ,  $V_{OUT} = 5V$ ,  $SET = GND$ ,  $T_A = +25^\circ C$ , unless otherwise specified.)

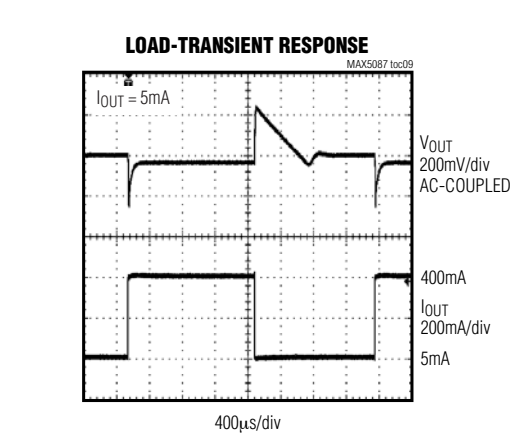
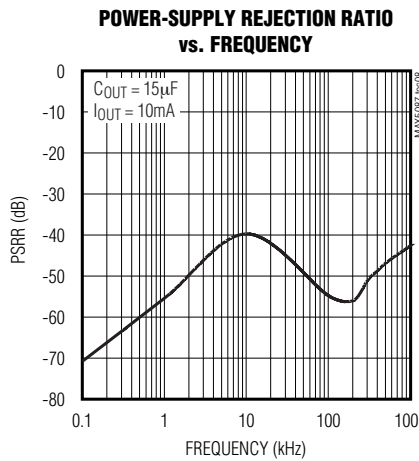
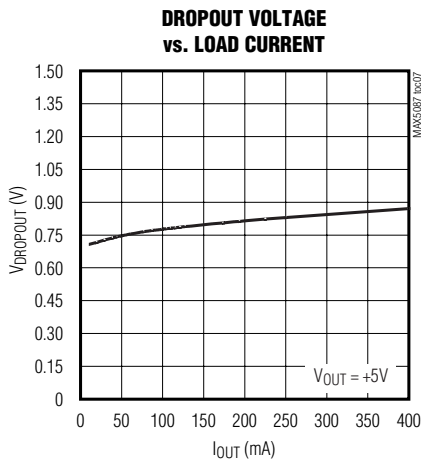
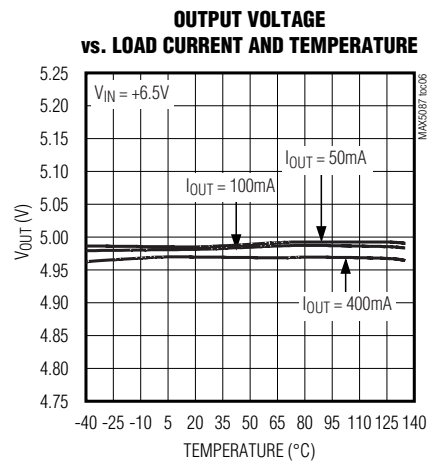
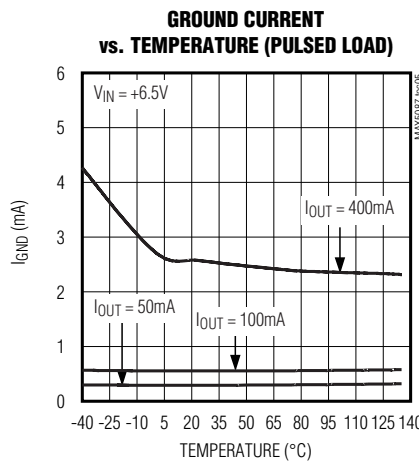
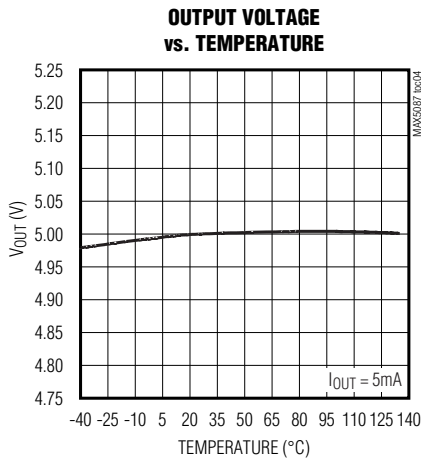
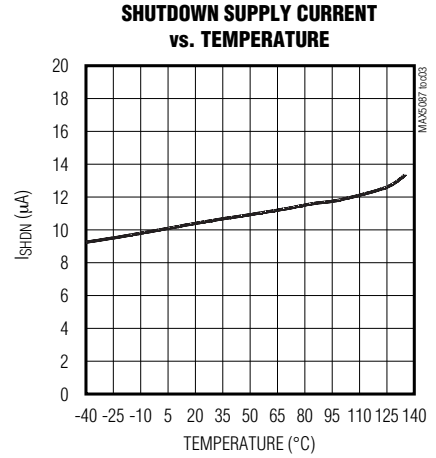
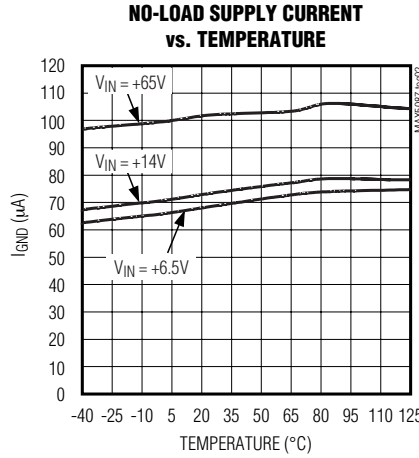
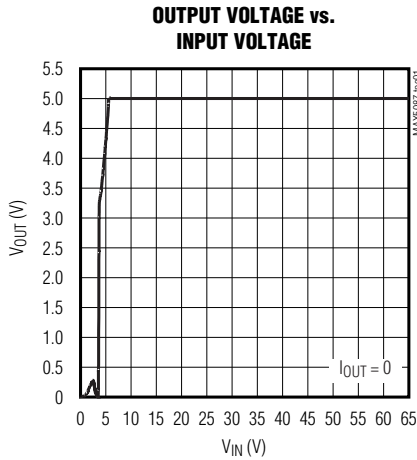

# 65V, 400mA, Low-Quiescent-Current Linear Regulator with Adjustable Reset Delay

**MAX5087**

## Typical Operating Characteristics (continued)

( $V_{IN} = V_{EN} = 14V$ ,  $C_{IN} = 10\mu F$ ,  $C_{OUT} = 15\mu F$ ,  $V_{OUT} = 5V$ ,  $SET = GND$ ,  $T_A = +25^\circ C$ , unless otherwise specified.)

**INPUT VOLTAGE STEP RESPONSE**

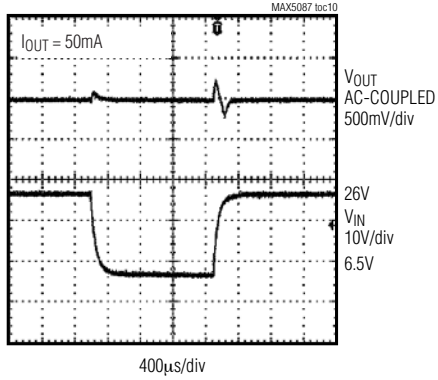

**STARTUP RESPONSE**

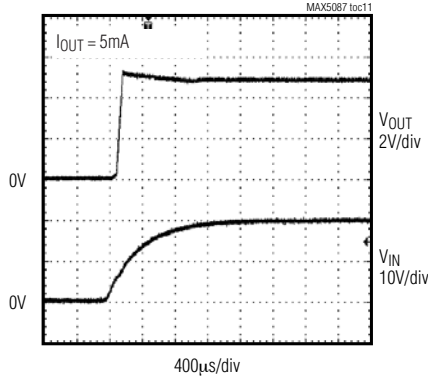

**ENABLE STARTUP RESPONSE**

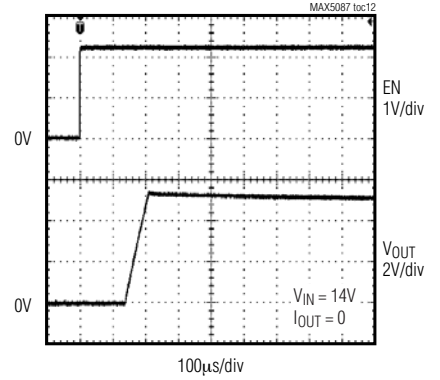

**ENABLE STARTUP RESPONSE**

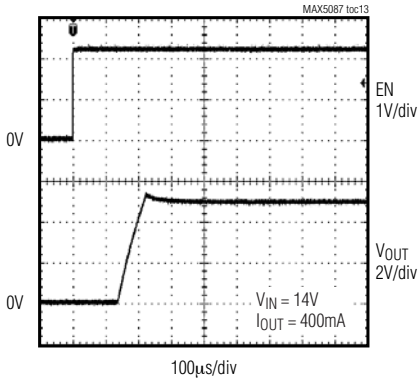

**ENABLE STARTUP RESPONSE**

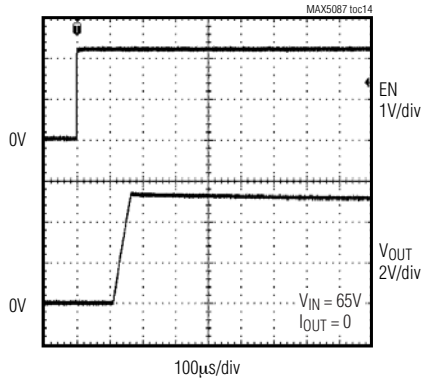

**ENABLE STARTUP RESPONSE**

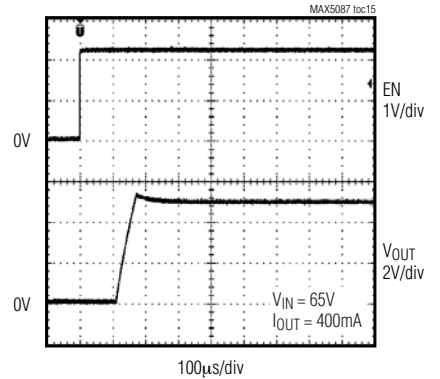

**SHUTDOWN RESPONSE**

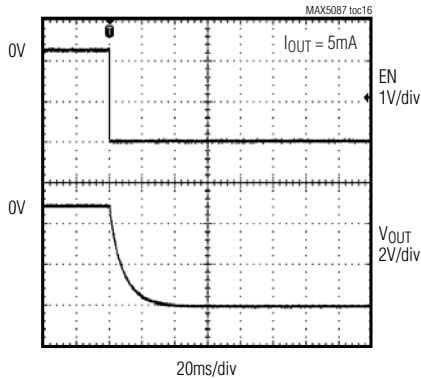

**GROUND CURRENT DISTRIBUTION ( $T_A = -40^\circ C$ )**

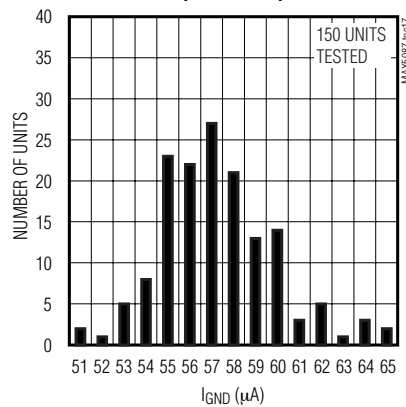

**GROUND CURRENT DISTRIBUTION ( $T_A = +125^\circ C$ )**

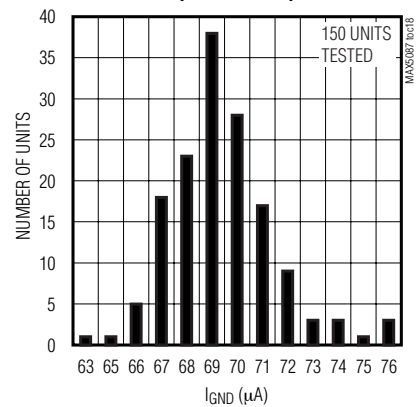

# 65V, 400mA, Low-Quiescent-Current Linear Regulator with Adjustable Reset Delay

## Pin Description

PIN		NAME	FUNCTION
16-PIN TQFN	56-PIN TQFN		
1, 12–16	1–13, 15, 18–20, 25–28, 32–56	N.C.	No Connection. Not internally connected.
2	14	EN	Enable Input. Drive EN high to turn on the regulator. Force EN low to place the device in shutdown mode.
3, 4	16, 17	IN	Regulator Input. Supply voltage ranges from 6.5V to 65V. Bypass IN to GND with a 10 $\mu$ F capacitor.
5, 6	21, 22	OUT	Regulator Output. Connect at least a 15 $\mu$ F low-ESR capacitor from OUT to GND.
7	23	OUTSENSE	Regulator Output Feedback Point. OUTSENSE must be connected to OUT for fixed output voltage versions. Leave OUTSENSE open for adjustable output voltage version.
8	24	GND	Ground
9	29	SET	Feedback Regulation Set Point. Connect SET to GND for a fixed 3.3V output (MAX5087A) or 5.0V output (MAX5087B). Connect an external resistive divider network from OUTSENSE to SET to GND to adjust the output voltage from 2.5V to 11V.
10	30	$\overline{\text{RESET}}$	Open-Drain Active-Low Reset Output. Connect a 10k $\Omega$ pullup resistor from $\overline{\text{RESET}}$ to any supply voltage up to 11V to create a logic output.
11	31	CT	Reset Timeout Setting Connection. A 2 $\mu$ A charging current is available at CT. Connect a capacitor from CT to GND to set the reset timeout period (see the <i>Adjustable Reset Timeout Period (CT)</i> section).
—	—	EP	Exposed Paddle. Connect externally to a large ground plane to aid heat dissipation. Do not use EP as a ground connection.

# 65V, 400mA, Low-Quiescent-Current Linear Regulator with Adjustable Reset Delay

MAX5087

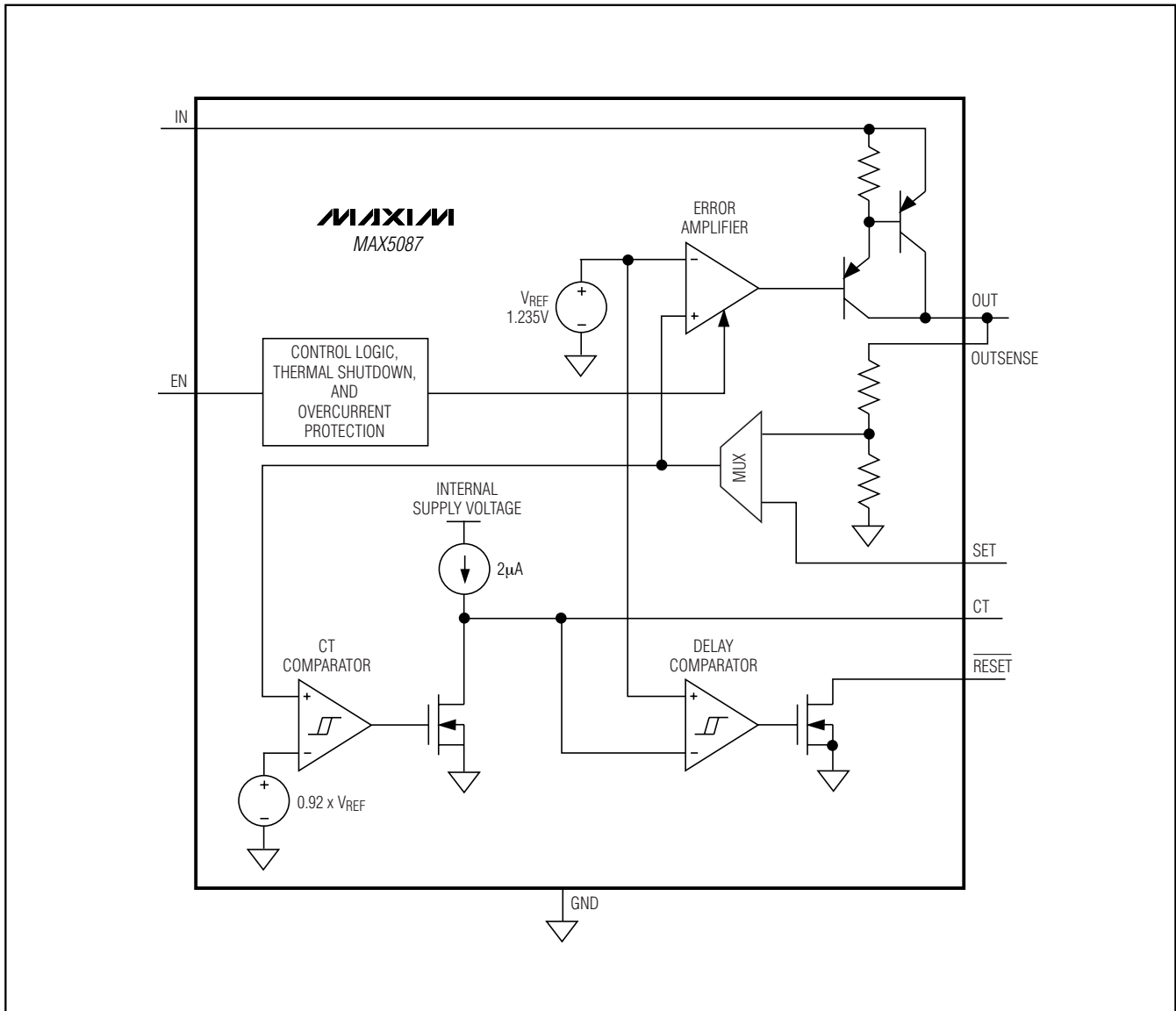

Figure 1. Functional Diagram

# 65V, 400mA, Low-Quiescent-Current Linear Regulator with Adjustable Reset Delay

## Detailed Description

The MAX5087 high-voltage linear regulator includes an integrated  $\mu\text{P}$  reset circuit with an adjustable reset timeout period (see the *Adjustable Reset Timeout Period (CT)* section). The device guarantees a 400mA load current and is available with a preset output voltage of 3.3V (MAX5087A) or 5V (MAX5087B). Both devices can be configured to provide an adjustable output voltage from 2.5V to 11V. The internal reset circuit monitors the regulator output voltage and asserts  $\overline{\text{RESET}}$  low when the regulator output falls below the reset threshold voltage. Other features include an enable (regulator control input), 21 $\mu\text{A}$  (max) shutdown current, short-circuit protection (see the *Output Short-Circuit Current Limit* section), and thermal shutdown (see the *Thermal Protection* section).

### Regulator

The MAX5087 accepts an input voltage range from 6.5V to 65V and offers a fixed output voltage of 3.3V or 5V. For an adjustable output voltage operation, use an external resistive divider network connected between OUT, SET, and GND (see Figure 2).

### Enable Input (EN)

EN is a logic-level enable input that turns the device on/off. Drive EN high to turn on the device and drive EN low to place the device in shutdown. The MAX5087 draws 11 $\mu\text{A}$  (typ) of supply current when in shutdown. EN withstands voltages up to +70V, allowing EN to be connected to IN for an always-on operation.

### Remote Sensing (OUTSENSE)

The 3.3V (MAX5087A) and 5V (MAX5087B) output voltage versions connect OUTSENSE for load voltage sensing. Leave OUTSENSE open when using adjustable output voltage version.

### Reset Output ( $\overline{\text{RESET}}$ )

A supervisor circuit is fully integrated in the MAX5087 and uses the same reference voltage as the regulator.  $\overline{\text{RESET}}$  goes low if  $V_{\text{OUT}}$  drops below the preset output voltage threshold, and remains low at least for the timeout period after  $V_{\text{OUT}}$  rises above the reset voltage threshold.

### Adjustable Reset Timeout Period (CT)

The MAX5087 features a user-adjustable reset timeout. Connect a capacitor from CT to GND to set the reset

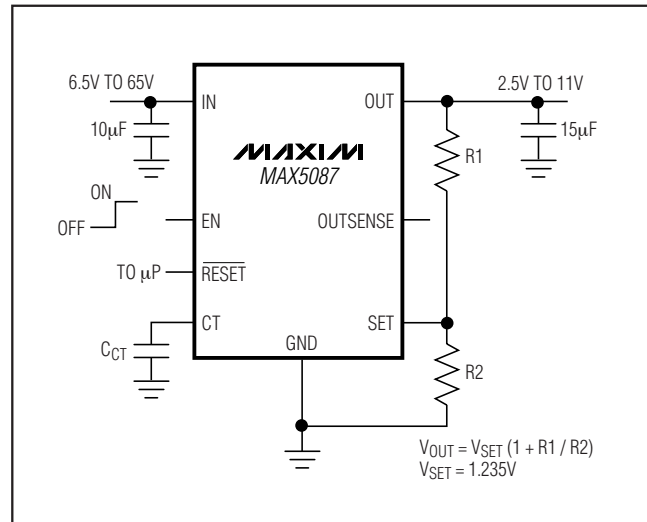

Figure 2. Setting the Adjustable Output Voltage

timeout period (see Figure 2) and use the following equation to calculate the timeout period:

$$t_{\text{RP}} = C_{\text{CT}} \times 0.6175 \times 10^6 \text{ (s)}$$

where  $C_{\text{CT}}$  is the value of the external capacitor connected from CT to GND.

### Thermal Protection

When the junction temperature exceeds  $T_{\text{J}} = +175^{\circ}\text{C}$ , an internal thermal sensor signals the shutdown logic, which turns off the pass transistor, allowing the IC to cool. The thermal sensor turns the pass transistor on again after the IC's junction temperature cools by  $25^{\circ}\text{C}$ , resulting in a cycled output during continuous thermal-overload conditions. Thermal protection protects the MAX5087 in the event of fault conditions. During continuous operation, do not exceed the absolute maximum junction temperature rating of  $T_{\text{J}} = +150^{\circ}\text{C}$ .

### Output Short-Circuit Current Limit

The MAX5087 features a current limit. The output can be shorted to GND for an indefinite period of time (for  $V_{\text{IN}} < 14\text{V}$ ) without damage to the device. Continuous output short-circuit protection is only guaranteed for  $V_{\text{IN}} < 14\text{V}$ .



# 65V, 400mA, Low-Quiescent-Current Linear Regulator with Adjustable Reset Delay

**MAX5087**

## Applications Information

### Output-Voltage Selection

The MAX5087 features a Dual Mode™ operation, in either a preset-voltage mode or an adjustable mode. In preset-voltage mode, internal feedback resistors set the MAX5087's output voltage to +3.3V or +5V. Select preset-voltage mode by connecting SET to ground. In adjustable mode, select an output between +2.5V and +11V using two external resistors connected as a voltage-divider to SET (Figure 2). Set the output voltage using the following equation:

$$V_{OUT} = V_{SET} \times \left(1 + \frac{R1}{R2}\right)$$

where  $V_{SET} = 1.235V$  and  $R2$  is chosen to be  $< 100k\Omega$ .

### Available Output-Current Calculation

The MAX5087 high-voltage regulator provides up to 400mA of output current. The input voltage extends to +65V. Package power dissipation limits the amount of output current available for a given input/output voltage and ambient temperature. Figure 3 shows the maximum power dissipation curve for these devices. The graph assumes that the exposed paddle of the MAX5087 package is set up per JEDEC 51 (multilayer board) specifications.

Use Figure 3 to determine the allowable package dissipation ( $P_D$ ) for a given ambient temperature. Alternately, use the following formulas to calculate the allowable package dissipation. Note that for the examples shown below, the electrical characteristic limits are guaranteed up to  $T_J = +125^\circ C$  (max).

For the 56-pin TQFN package:

$$P_D = \begin{cases} 3.809W & \text{for } T_A \leq +70^\circ C \\ 3.809W - 0.0476 \frac{W}{^\circ C} \times (T_A - 70^\circ C) & \text{for } +70^\circ C < T_A \leq +125^\circ C \end{cases}$$

For the 16-pin TQFN package:

$$P_D = \begin{cases} 2.666W & \text{for } T_A \leq +70^\circ C \\ 2.666W - 0.0333 \frac{W}{^\circ C} \times (T_A - 70^\circ C) & \text{for } +70^\circ C < T_A \leq +125^\circ C \end{cases}$$

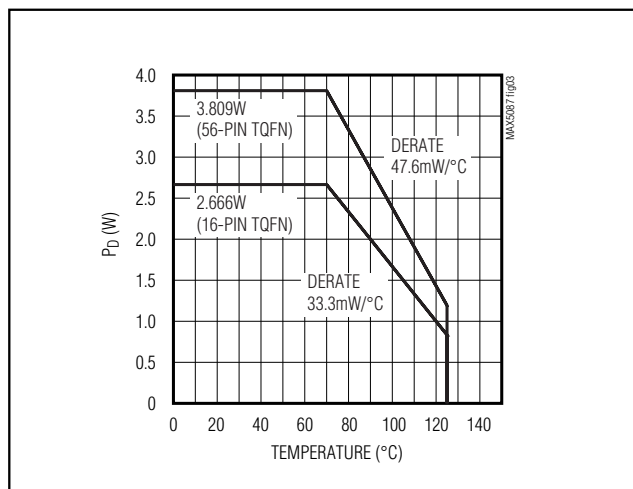

Figure 3. Calculated Maximum Power Dissipation vs. Temperature

After determining the allowable package dissipation calculate the maximum output current using the following formula:

$$I_{OUT(MAX)} \approx \frac{P_D}{V_{IN} - V_{OUT}} \leq 400mA$$

The above equations do not include the negligible power dissipation from self-heating due to the IC ground current.

### Example 1: MAX5087BATN+

$T_A = +95^\circ C$

$V_{IN} = +14V$

$V_{OUT} = +5V$

Find the maximum allowable output current. First calculate package dissipation at the given temperature as follows:

$$P_D = 3.809W - 0.0476 \frac{W}{^\circ C} (95^\circ C - 70^\circ C) = 2.619W$$

Then determine the maximum output current:

$$I_{OUT(MAX)} = \frac{(2.619W)}{(14V) - (5V)} = 291mA$$

Dual Mode is a trademark of Maxim Integrated Products, Inc.

# 65V, 400mA, Low-Quiescent-Current Linear Regulator with Adjustable Reset Delay

## Example 2: MAX5087AATN+

$$T_A = +125^\circ\text{C}$$

$$V_{IN} = +14\text{V}$$

$$V_{OUT} = +3.3\text{V}$$

Calculate package dissipation at the given temperature as follows:

$$P_D = 3.809\text{W} - 0.0476 \frac{\text{W}}{^\circ\text{C}} (125^\circ\text{C} - 70^\circ\text{C}) = 1.191\text{W}$$

And establish the maximum current:

$$I_{OUT(MAX)} = \frac{(1.191\text{W})}{(14\text{V}) - (3.3\text{V})} = 111.3\text{mA}$$

## Example 3: MAX5087BATN+

$$T_A = +50^\circ\text{C}$$

$$V_{IN} = +14\text{V}$$

$$V_{OUT} = +5\text{V}$$

Calculate package dissipation at the given temperature as follows:

$$P_D = 3.809\text{W}$$

And find the maximum output current:

$$I_{OUT(MAX)} = \frac{(3.809\text{W})}{(14\text{V}) - (5\text{V})} = 423.2\text{mA} \Rightarrow I_{OUT(MAX)} = 400\text{mA}$$

In example 3 the maximum output current is calculated as 423mA, however, the maximum output current cannot exceed 400mA.

Use Figures 4a and 4b to quickly determine maximum allowable output current for selected ambient temperatures.

### Output-Capacitor Selection and Regulator Stability

For stable operation over the full temperature range and with load currents up to 400mA, use a 15 $\mu\text{F}$  (min) output capacitor with an ESR < 0.25 $\Omega$ . To reduce noise and improve load-transient response, stability, and power-supply rejection use larger output capacitor values such as 22 $\mu\text{F}$ .

Some ceramic capacitor dielectrics exhibit large capacitance and ESR variation with temperature. For capacitor dielectrics such as Y5V, use 22 $\mu\text{F}$  or more to ensure stability at temperatures below -10 $^\circ\text{C}$ . With X7R or X5R dielectrics, 15 $\mu\text{F}$  should be sufficient at all oper-

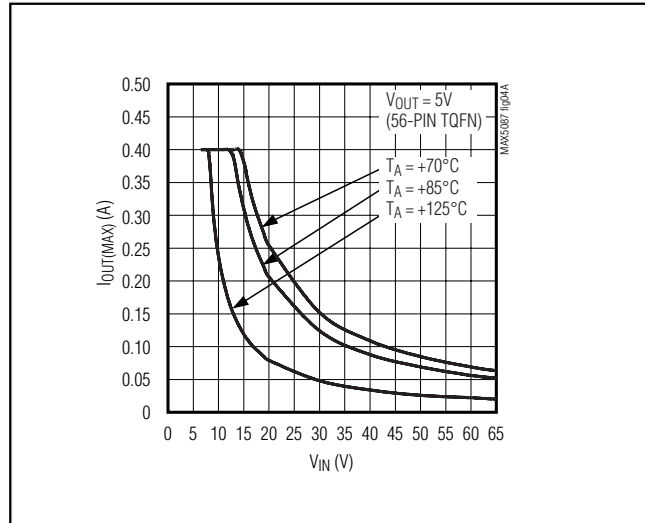

Figure 4a. Maximum Output Current vs. Input Voltage (56-Pin TQFN)

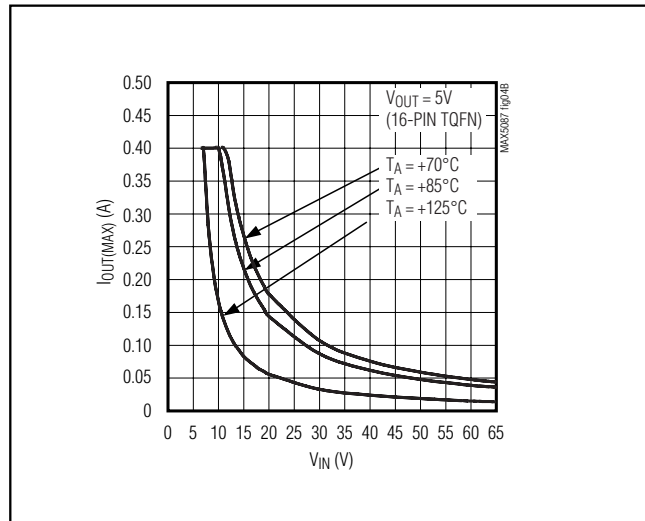

Figure 4b. Maximum Output Current vs. Input Voltage (16-Pin TQFN)

ating temperatures. To improve power supply rejection and transient response, use a minimum 10 $\mu\text{F}$  capacitor from IN to GND.

### Chip Information

PROCESS: BiCMOS

# 65V, 400mA, Low-Quiescent-Current Linear Regulator with Adjustable Reset Delay

## Package Information

(The package drawing(s) in this data sheet may not reflect the most current specifications. For the latest package outline information, go to [www.maxim-ic.com/packages](http://www.maxim-ic.com/packages).)

MAX5087

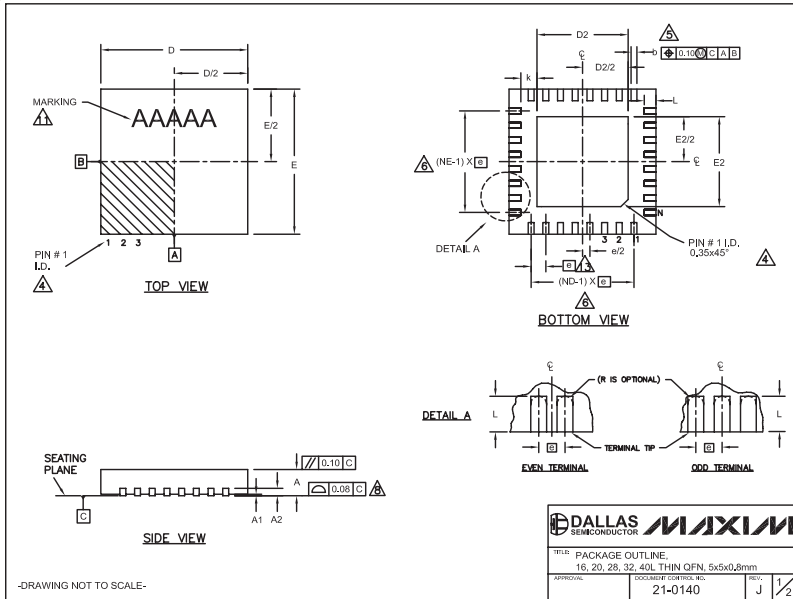

QFN THINLEPS

PKG. SYMBOL	COMMON DIMENSIONS														
	16L 5x5		20L 5x5		28L 5x5		32L 5x5		40L 5x5						
	MIN.	NOM.	MAX.	MIN.	NOM.	MAX.	MIN.	NOM.	MAX.	MIN.	NOM.	MAX.			
A	0.70	0.75	0.80	0.70	0.75	0.80	0.70	0.75	0.80	0.70	0.75	0.80			
A1	0	0.02	0.05	0	0.02	0.05	0	0.02	0.05	0	0.02	0.05			
A2	0.20 REF.		0.20 REF.		0.20 REF.		0.20 REF.		0.20 REF.						
b	0.25	0.30	0.35	0.25	0.30	0.35	0.25	0.30	0.20	0.25	0.30	0.15	0.20	0.25	
D	4.50	5.00	5.10	4.90	5.00	5.10	4.90	5.00	5.10	4.90	5.00	5.10	4.90	5.00	5.10
E	4.90	5.00	5.10	4.90	5.00	5.10	4.90	5.00	5.10	4.90	5.00	5.10	4.90	5.00	5.10
e	0.80 BSC.		0.65 BSC.		0.50 BSC.		0.50 BSC.		0.50 BSC.		0.40 BSC.				
k	0.25	-	-	0.25	-	-	0.25	-	-	0.25	-	-	-	-	-
L	0.30	0.40	0.50	0.45	0.55	0.65	0.45	0.55	0.65	0.30	0.40	0.50	0.30	0.40	0.50
N	16		20		28		32		40						
ND	4		5		7		8		10						
NE	4		5		7		8		10						
JEDEC	WHHB		WHHC		WHHD-1		WHHD-2		---						

PKG. CODES	EXPOSED PAD VARIATIONS					
	D2			E2		
	MIN.	NOM.	MAX.	MIN.	NOM.	MAX.
T1655-2	3.00	3.10	3.20	3.00	3.10	3.20
T1655-3	3.00	3.10	3.20	3.00	3.10	3.20
T1655N-1	3.00	3.10	3.20	3.00	3.10	3.20
T2055-3	3.00	3.10	3.20	3.00	3.10	3.20
T2055-4	3.00	3.10	3.20	3.00	3.10	3.20
T2055-5	3.15	3.25	3.35	3.15	3.25	3.35
T2855-3	3.15	3.25	3.35	3.15	3.25	3.35
T2855-4	2.60	2.70	2.80	2.60	2.70	2.80
T2855-5	2.60	2.70	2.80	2.60	2.70	2.80
T2855-6	3.15	3.25	3.35	3.15	3.25	3.35
T2855-7	2.60	2.70	2.80	2.60	2.70	2.80
T2855-8	3.15	3.25	3.35	3.15	3.25	3.35
T2855N-1	3.15	3.25	3.35	3.15	3.25	3.35
T3255-3	3.00	3.10	3.20	3.00	3.10	3.20
T3255-4	3.00	3.10	3.20	3.00	3.10	3.20
T3255-5	3.00	3.10	3.20	3.00	3.10	3.20
T3255N-1	3.00	3.10	3.20	3.00	3.10	3.20
T4055-1	3.40	3.50	3.60	3.40	3.50	3.60

NOTES:

- DIMENSIONING & TOLERANCING CONFORM TO ASME Y14.5M-1994.
- ALL DIMENSIONS ARE IN MILLIMETERS, ANGLES ARE IN DEGREES.
- N IS THE TOTAL NUMBER OF TERMINALS.

# 65V, 400mA, Low-Quiescent-Current Linear Regulator with Adjustable Reset Delay

## Package Information (continued)

(The package drawing(s) in this data sheet may not reflect the most current specifications. For the latest package outline information, go to [www.maxim-ic.com/packages](http://www.maxim-ic.com/packages).)

<p>△ THE TERMINAL #1 IDENTIFIER AND TERMINAL NUMBERING CONVENTION SHALL CONFORM TO JEDEC SPP-012. DETAILS OF TERMINAL #1 IDENTIFIER ARE OPTIONAL, BUT MUST BE LOCATED WITHIN THE ZONE INDICATED. THE TERMINAL #1 IDENTIFIER MAY BE EITHER A MOLD OR MARKED FEATURE.</p> <p>△ DIMENSION b APPLIES TO METALLIZED TERMINAL AND IS MEASURED BETWEEN 0.25 mm AND 0.30 mm FROM TERMINAL TIP.</p> <p>△ D AND NE REFER TO THE NUMBER OF TERMINALS ON EACH D AND E SIDE RESPECTIVELY.</p> <p>△ DEPOPULATION IS POSSIBLE IN A SYMMETRICAL FASHION.</p> <p>△ COPLANARITY APPLIES TO THE EXPOSED HEAT SINK SLUG AS WELL AS THE TERMINALS.</p> <p>9. DRAWING CONFORMS TO JEDEC MO220, EXCEPT EXPOSED PAD DIMENSION FOR T2855-3 AND T2855-6.</p> <p>△ WARPAGE SHALL NOT EXCEED 0.10 mm.</p> <p>11. MARKING IS FOR PACKAGE ORIENTATION REFERENCE ONLY.</p> <p>12. NUMBER OF LEADS SHOWN ARE FOR REFERENCE ONLY.</p> <p>△ LEAD CENTERLINES TO BE AT TRUE POSITION AS DEFINED BY BASIC DIMENSION "e", ±0.05.</p>	<p>14055-Z   3.40   3.50   3.60   3.40   3.50   3.60  </p> <p>**SEE COMMON DIMENSIONS TABLE</p>
	
<p>FIG. PACKAGE OUTLINE: 16, 20, 28, 32, 40L THIN QFN, 5x5x0.8mm</p>	
<p>APPROVAL</p>	<p>DOCUMENT CONTROL, INC.</p>
<p>21-0140</p>	<p>REC. J 2/2</p>

-DRAWING NOT TO SCALE-



# 65V, 400mA, Low-Quiescent-Current Linear Regulator with Adjustable Reset Delay

## Package Information (continued)

(The package drawing(s) in this data sheet may not reflect the most current specifications. For the latest package outline information, go to [www.maxim-ic.com/packages](http://www.maxim-ic.com/packages).)

### NOTES:

1. DIE THICKNESS ALLOWABLE IS 0.225mm MAXIMUM (0.009 INCHES MAXIMUM).
2. DIMENSIONING & TOLERANCES CONFORM TO ASME Y14.5M. - 1994.
3. N IS THE NUMBER OF TERMINALS.  
Nd IS THE NUMBER OF TERMINALS IN X-DIRECTION &  
Ne IS THE NUMBER OF TERMINALS IN Y-DIRECTION.
4. DIMENSION b APPLIES TO PLATED TERMINAL AND IS MEASURED BETWEEN 0.20 AND 0.25mm FROM TERMINAL TIP.
5. THE PIN #1 IDENTIFIER MUST BE LOCATED ON THE TOP SURFACE OF THE PACKAGE WITHIN HATCHED AREA AS SHOWN. EITHER AN INDENTATION MARK OR INK/LASER MARK IS ACCEPTABLE.
6. ALL DIMENSIONS ARE IN MILLIMETERS.
7. PACKAGE WARPAGE MAX 0.01mm.
8. APPLIES TO EXPOSED PAD AND TERMINALS. EXCLUDES INTERNAL DIMENSION OF EXPOSED PAD.
9. MEETS JEDEC MO220.
10. MARKING IS FOR PACKAG ORIENTATION REFERENCE ONLY
11. NUMBER OF LEADS ARE FOR REFERENCE ONLY

SYMBOL	56L 8x8			NOTE
	MIN.	NOM.	MAX.	
A	0.70	0.75	0.80	
b	0.20	0.25	0.30	4
D	7.90	8.00	8.10	
E	7.90	8.00	8.10	
Ⓜ	0.50 BSC			
N	56			3
Nd	14			3
Ne	14			3
L	0.30	0.40	0.50	
A1	0.00	0.02	0.05	
A2	0.20 REF			
k	0.25	--	--	

PKG. CODE	EXPOSED PAD VARIATION						JEDEC	DOWN BONDS ALLOWED
	D2			E2				
	MIN.	NOM.	MAX.	MIN.	NOM.	MAX.		
T5688-2	6.50	6.65	6.70	6.50	6.65	6.70	WLLD-5	YES
T5688-3	6.50	6.65	6.70	6.50	6.65	6.70	WLLD-5	NO

-DRAWING NOT TO SCALE-

TITLE: PACKAGE OUTLINE 56L THIN QFN, 8x8x0.8mm			
APPROVAL	DOCUMENT CONTROL NO.	REV.	
	21-0135	E	2/2

## Revision History

Pages changed at Rev 2: 2, 14

Maxim cannot assume responsibility for use of any circuitry other than circuitry entirely embodied in a Maxim product. No circuit patent licenses are implied. Maxim reserves the right to change the circuitry and specifications without notice at any time.

14 \_\_\_\_\_ **Maxim Integrated Products, 120 San Gabriel Drive, Sunnyvale, CA 94086 408-737-7600**

SITE  
SEARCHPART NO.  
SEARCH

WHAT'S NEW

PRODUCTS

SOLUTIONS

DESIGN

APPNOTES

SUPPORT

BUY

COMPANY

MEMBERS

[Maxim](#) > [Products](#) > [Power and Battery Management](#)

# MAX5087

65V, 400mA, Low-Quiescent-Current Linear Regulator with Adjustable Reset Delay

## 400mA, 65V Input, Low-Quiescent-Current Linear Regulators in High-Power TQFN Packages

[QuickView](#)[Technical Documents](#)[Ordering Info](#)[More Information](#)[All](#)

### Ordering Information

Notes:

1. Other options and links for purchasing parts are listed at: <http://www.maxim-ic.com/sales>.
2. [Didn't Find What You Need?](#) Ask our applications engineers. Expert assistance in finding parts, usually within one business day.
3. Part number suffixes: T or T&R = tape and reel; + = RoHS/lead-free; # = RoHS/lead-exempt. More: See [Full Data Sheet](#) or [Part Naming Conventions](#).
4. \* Some packages have variations, listed on the drawing. "PkgCode/Variation" tells which variation the product uses.

### Devices: 1-8 of 8

MAX5087A	Free Sample	Buy	Package: TYPE PINS FOOTPRINT DRAWING CODE/VAR *	Temp	RoHS/Lead-Free? Materials Analysis
MAX5087AATE			THIN QFN;16 pin;26 mm Dwg: <a href="#">21-0140L</a> (PDF) Use pkgcode/variation: T1655-2*	-40C to +125C	RoHS/Lead-Free: See data sheet <a href="#">Materials Analysis</a>
MAX5087AATE+T			THIN QFN;16 pin;26 mm Dwg: <a href="#">21-0140L</a> (PDF) Use pkgcode/variation: T1655+2*	-40C to +125C	RoHS/Lead-Free: <a href="#">Lead Free</a> <a href="#">Materials Analysis</a>
MAX5087AATE+			THIN QFN;16 pin;26 mm Dwg: <a href="#">21-0140L</a> (PDF) Use pkgcode/variation: T1655+2*	-40C to +125C	RoHS/Lead-Free: <a href="#">Lead Free</a> <a href="#">Materials Analysis</a>
MAX5087AATE-T			THIN QFN;16 pin;26 mm Dwg: <a href="#">21-0140L</a> (PDF) Use pkgcode/variation: T1655-2*	-40C to +125C	RoHS/Lead-Free: See data sheet <a href="#">Materials Analysis</a>
MAX5087B	Free Sample	Buy	Package: TYPE PINS FOOTPRINT DRAWING CODE/VAR *	Temp	RoHS/Lead-Free? Materials Analysis
MAX5087BATE			THIN QFN;16 pin;26 mm Dwg: <a href="#">21-0140L</a> (PDF) Use pkgcode/variation: T1655-2*	-40C to +125C	RoHS/Lead-Free: See data sheet <a href="#">Materials Analysis</a>
MAX5087BATE+			THIN QFN;16 pin;26 mm Dwg: <a href="#">21-0140L</a> (PDF) Use pkgcode/variation: T1655+2*	-40C to +125C	RoHS/Lead-Free: <a href="#">Lead Free</a> <a href="#">Materials Analysis</a>
MAX5087BATE+T			THIN QFN;16 pin;26 mm Dwg: <a href="#">21-0140L</a> (PDF) Use pkgcode/variation: T1655+2*	-40C to +125C	RoHS/Lead-Free: <a href="#">Lead Free</a> <a href="#">Materials Analysis</a>
MAX5087BATE-T			THIN QFN;16 pin;26 mm Dwg: <a href="#">21-0140L</a> (PDF) Use pkgcode/variation: T1655-2*	-40C to +125C	RoHS/Lead-Free: See data sheet <a href="#">Materials Analysis</a>

### Didn't Find What You Need?

- [Next Day Product Selection Assistance from Applications Engineers](#)
- [Parametric Search](#)
- [Applications Help](#)

### QuickView

[Description](#)  
[Key Features](#)  
[Applications/Uses](#)  
[Key Specifications](#)  
[Diagram](#)

### Technical Documents

[Data Sheet](#)  
[Application Notes](#)  
[Design Guides](#)  
[Engineering Journals](#)  
[Reliability Reports](#)  
[Software/Models](#)  
[Evaluation Kits](#)

### Ordering Info

[Price and Availability](#)  
[Samples](#)  
[Buy Online](#)  
[Package Information](#)  
[Lead-Free Information](#)

### More Information

[Related Products](#)  
[Notes and Comments](#)  
[Evaluation Kits](#)

Document Ref.: 19-3964; Rev 2; 2006-08-07  
This page last modified: 2006-12-12

[CONTACT US: SEND US AN EMAIL](#)