

QM100HC-M

HIGH POWER SWITCHING USE
NON-INSULATED TYPE

QM100HC-M



- **IC** Collector current **100A**
- **VCEX** Collector-emitter voltage **350V**
- **hFE** DC current gain **100**
- **Non-Insulated Type**

APPLICATION

Robotics, Forklifts, Welders

OUTLINE DRAWING & CIRCUIT DIAGRAM

Dimensions in mm

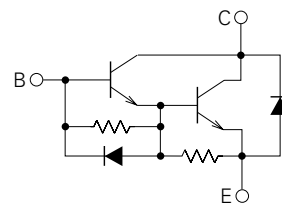
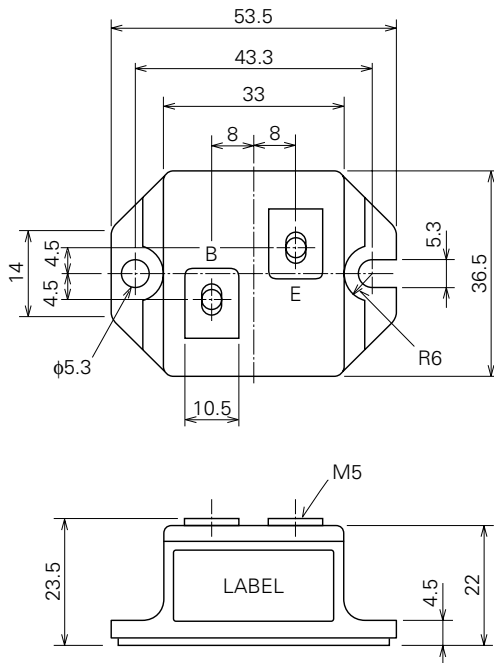

QM100HC-M

HIGH POWER SWITCHING USE

NON-INSULATED TYPE

ABSOLUTE MAXIMUM RATINGS (Tj=25°C, unless otherwise noted)

Symbol	Parameter	Conditions	Ratings	Unit
VCEX (SUS)	Collector-emitter voltage	IC=1A, VEB=2V	350	V
VCEX	Collector-emitter voltage	VEB=2V	350	V
VCBO	Collector-base voltage	Emitter open	400	V
VEBO	Emitter-base voltage	Collector open	10	V
IC	Collector current	DC	100	A
-IC	Collector reverse current	DC (forward diode current)	100	A
PC	Collector dissipation	Tc=25°C	420	W
IB	Base current	DC	3	A
-ICSM	Surge collector reverse current (forward diode current)	Peak value of one cycle of 60Hz (half wave)	1000	A
Tj	Junction temperature		-40~+150	°C
Tstg	Storage temperature		-40~+125	°C
Viso	Isolation voltage	Charged part to case, AC for 1 minute	—	V
—	Mounting torque	Main terminal screw M5	1.47~1.96	N·m
			15~20	kg·cm
		Mounting screw M5	1.47~1.96	N·m
			15~20	kg·cm
—	Weight	Typical value	90	g

ELECTRICAL CHARACTERISTICS (Tj=25°C, unless otherwise noted)

Symbol	Parameter	Test conditions	Limits			Unit
			Min.	Typ.	Max.	
ICEX	Collector cutoff current	VCE=350V, VEB=2V	—	—	1.0	mA
ICBO	Collector cutoff current	VCB=400V, Emitter open	—	—	1.0	mA
IEBO	Emitter cutoff current	VEB=10V	—	—	200	mA
VCE (sat)	Collector-emitter saturation voltage	IC=100A, IB=1A	—	—	2.0	V
VBE (sat)	Base-emitter saturation voltage		—	—	2.5	V
-VCEO	Collector-emitter reverse voltage	-IC=100A (diode forward voltage)	—	—	1.5	V
hFE	DC current gain	IC=100A, VCE=2V/5V	100/200	—	—	—
ton	Switching time	VCC=200V, IC=100A, IB1=-IB2=2A	—	—	2.0	μs
ts			—	—	10	μs
tf			—	—	3.0	μs
Rth (j-c) Q	Thermal resistance (junction to case)	Transistor part	—	—	0.3	°C/W
Rth (j-c) R		Diode part	—	—	0.5	°C/W
Rth (c-f)	Contact thermal resistance (case to fin)	Conductive grease applied	—	—	0.15	°C/W

QM100HC-M

HIGH POWER SWITCHING USE
NON-INSULATED TYPE

PERFORMANCE CURVES

COMMON EMITTER OUTPUT CHARACTERISTICS (TYPICAL)

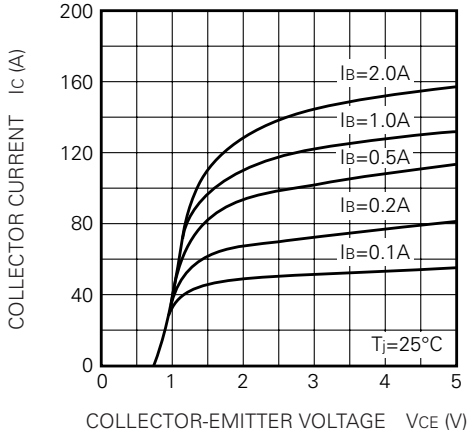

DC CURRENT GAIN VS. COLLECTOR CURRENT (TYPICAL)

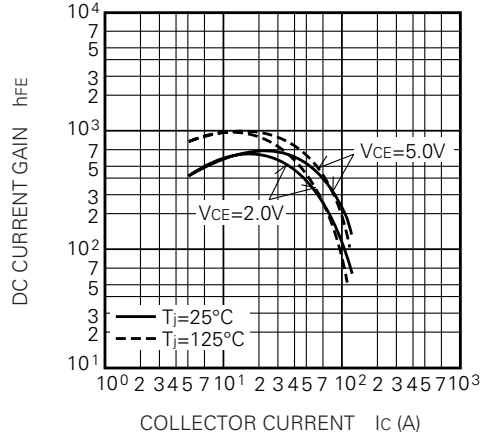

COMMON EMITTER INPUT CHARACTERISTIC (TYPICAL)

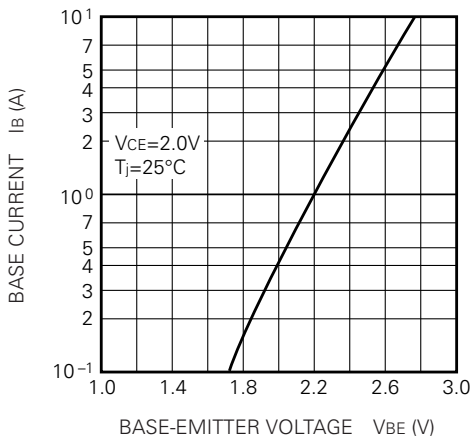

SATURATION VOLTAGE CHARACTERISTICS (TYPICAL)

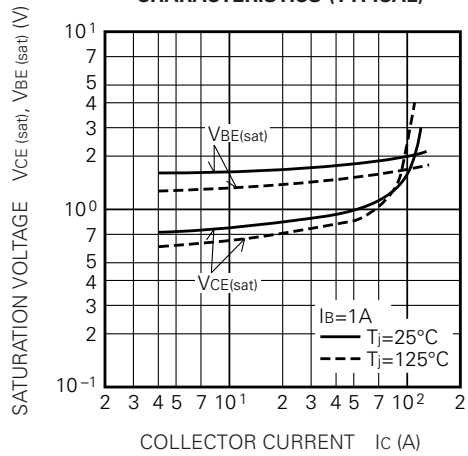

COLLECTOR-EMITTER SATURATION VOLTAGE (TYPICAL)

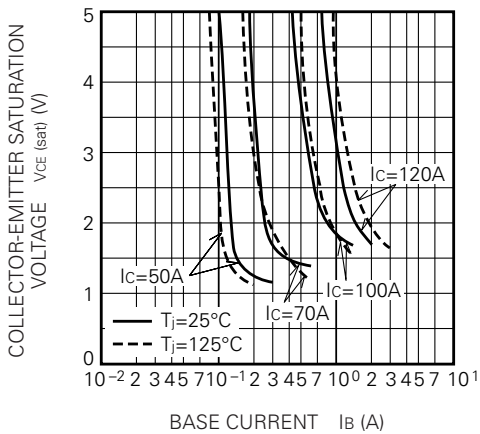

SWITCHING TIME VS. COLLECTOR CURRENT (TYPICAL)

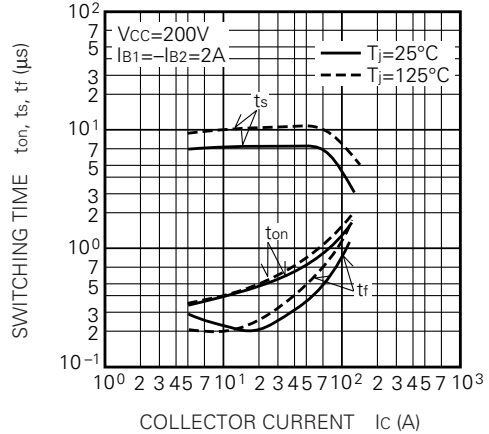

QM100HC-M

HIGH POWER SWITCHING USE
NON-INSULATED TYPE

SWITCHING TIME VS. BASE CURRENT (TYPICAL)

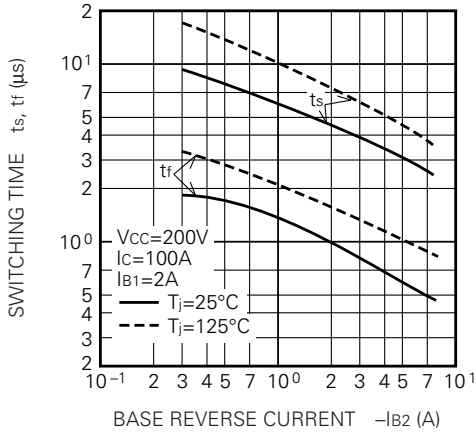

REVERSE BIAS SAFE OPERATING AREA

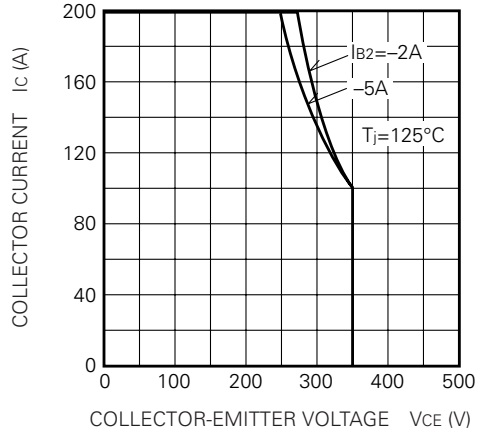

FORWARD BIAS SAFE OPERATING AREA

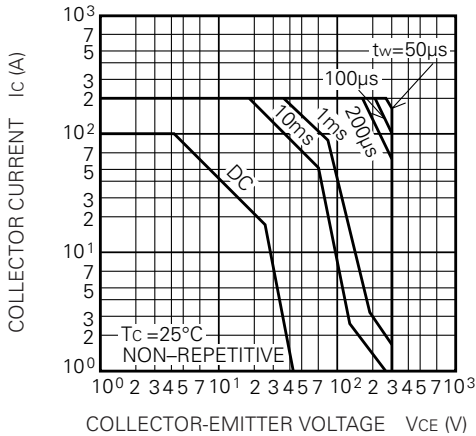

DERATING FACTOR OF F. B. S. O. A.

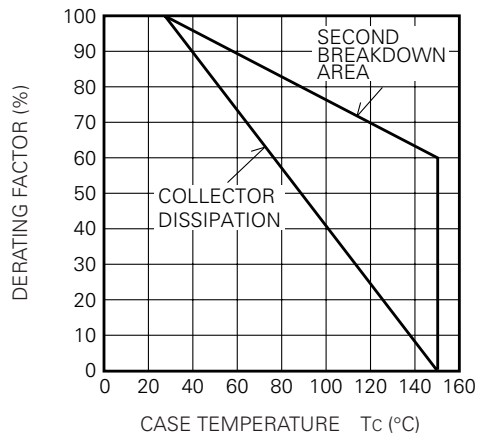

TRANSIENT THERMAL IMPEDANCE CHARACTERISTIC (TRANSISTOR)

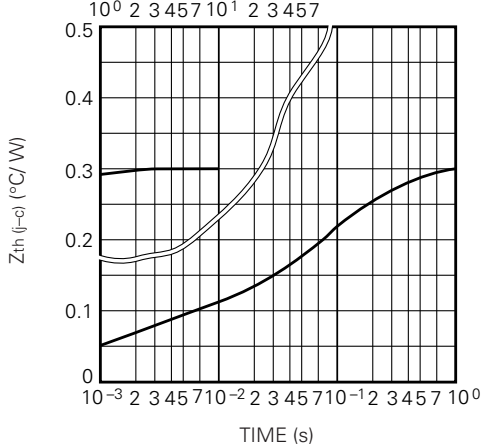

REVERSE COLLECTOR CURRENT VS. COLLECTOR-EMITTER REVERSE VOLTAGE (DIODE FORWARD CHARACTERISTICS) (TYPICAL)

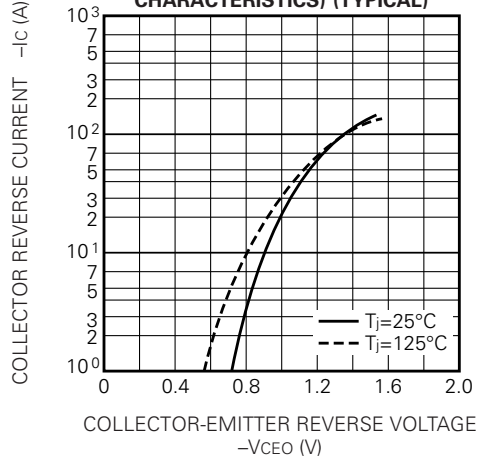

QM100HC-M

HIGH POWER SWITCHING USE
NON-INSULATED TYPE

**RATED SURGE COLLECTOR REVERSE CURRENT
(DIODE FORWARD SURGE CURRENT)**

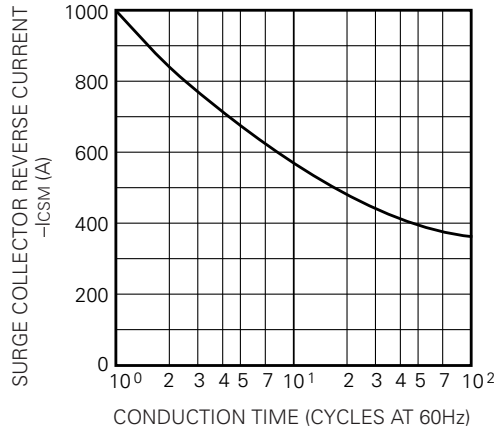

**REVERSE RECOVERY CHARACTERISTICS
OF FREE-WHEEL DIODE (TYPICAL)**

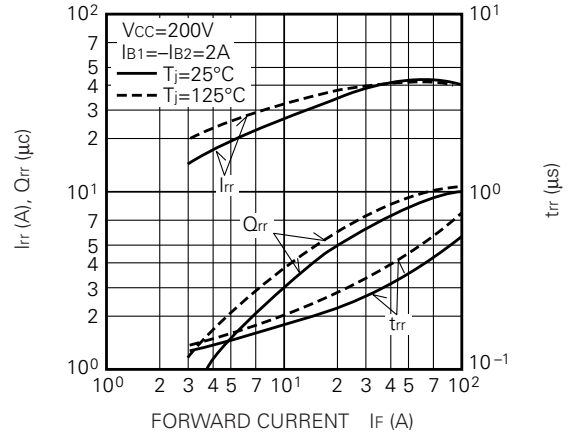

**TRANSIENT THERMAL IMPEDANCE
CHARACTERISTIC (DIODE)**

