



FEATURES

Input overvoltage protection, 32 V above and below the supply rails

Rail-to-rail input and output swing

Low power: 60 μ A per amplifier typical

Unity-gain bandwidth

800 kHz typical @ $V_{SY} = \pm 15$ V

550 kHz typical @ $V_{SY} = \pm 5$ V

465 kHz typical @ $V_{SY} = \pm 1.5$ V

Single-supply operation: 3 V to 30 V

Low offset voltage: 300 μ V maximum

High open-loop gain: 120 dB typical

Unity-gain stable

No phase reversal

Qualified for automotive applications

APPLICATIONS

Battery monitoring

Sensor conditioners

Portable power supply control

Portable instrumentation

GENERAL DESCRIPTION

The ADA4096-2 operational amplifier features micropower operation and rail-to-rail input and output ranges. The extremely low power requirements and guaranteed operation from 3 V to 30 V make these amplifiers perfectly suited to monitor battery usage and to control battery charging. Their dynamic performance, including 27 nV/ $\sqrt{\text{Hz}}$ voltage noise density, recommends them for battery-powered audio applications. Capacitive loads to 200 pF are handled without oscillation.

The ADA4096-2 has overvoltage protection inputs and diodes that allow the voltage input to extend 32 V above and below the supply rails, making this device ideal for robust industrial applications.

PIN CONFIGURATIONS



Figure 1. 8-Lead, MSOP (RM-8)

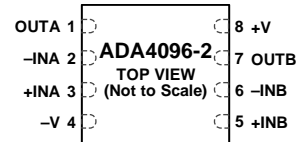

NOTES
1. CONNECT THE EXPOSED PAD TO GROUND.

Figure 2. 8-Lead LFCSP (CP-8-10)

The ADA4096-2 features a unique input stage that allows the input voltage to exceed either supply safely without any phase reversal or latch-up; this is called overvoltage protection, or OVP.

The dual ADA4096-2 is available in 8-lead LFCSP (2 mm \times 2 mm) and 8-lead MSOP packages. The ADA409x family is specified over the extended industrial temperature range (-40°C to $+125^{\circ}\text{C}$) and is part of the growing selection of 30 V, low power op amps from Analog Devices, Inc. (see Table 1).

Table 1. Low Power, 30 V Operational Amplifiers

Op Amp	Rail-to-Rail I/O	PJFET	Low Noise
Dual	ADA4091-2	AD8682	AD8622
Quad	ADA4091-4	AD8684	AD8624

Rev. A

Information furnished by Analog Devices is believed to be accurate and reliable. However, no responsibility is assumed by Analog Devices for its use, nor for any infringements of patents or other rights of third parties that may result from its use. Specifications subject to change without notice. No license is granted by implication or otherwise under any patent or patent rights of Analog Devices. Trademarks and registered trademarks are the property of their respective owners.

TABLE OF CONTENTS

Features	1	± 1.5 V Characteristics	8
Applications.....	1	± 5 V Characteristics.....	10
Pin Configurations	1	± 15 V Characteristics	12
General Description	1	Comparative Voltage and Variable Voltage Graphs.....	14
Revision History	2	Theory of Operation	15
Specifications.....	3	Input Stage.....	15
Electrical Specifications, $V_{SY} = \pm 1.5$ V.....	3	Phase Inversion.....	15
Electrical Specifications, $V_{SY} = \pm 5$ V.....	4	Input Overvoltage Protection	16
Electrical Specifications, $V_{SY} = \pm 15$ V.....	5	Comparator Operation.....	17
Absolute Maximum Ratings.....	7	Outline Dimensions	18
Thermal Resistance	7	Ordering Guide	19
ESD Caution.....	7	Automotive Products.....	19
Typical Performance Characteristics	8		

REVISION HISTORY

3/12—Rev. 0 to Rev. A

Changed -3 dB Closed-Loop Bandwidth from 97 kHz to 970 kHz (Table 2).....	3
Changed -3 dB Closed-Loop Bandwidth from 114 kHz to 1140 kHz (Table 3).....	4
Changed to -3 dB Closed-Loop Bandwidth from 152 kHz to 1520 kHz (Table 4).....	5
Updated Outline Dimensions	18

7/11—Revision 0: Initial Version

SPECIFICATIONS

ELECTRICAL SPECIFICATIONS, $V_{SY} = \pm 1.5\text{ V}$

$V_{SY} = \pm 1.5\text{ V}$, $V_{CM} = V_{SY}/2$, $T_A = 25^\circ\text{C}$, unless otherwise noted.

Table 2.

Parameter	Symbol	Test Conditions/Comments	Min	Typ	Max	Unit
INPUT CHARACTERISTICS						
Offset Voltage	V_{OS}	$0^\circ\text{C} \leq T_A \leq +125^\circ\text{C}$		35	300	μV
		$-40^\circ\text{C} \leq T_A \leq +125^\circ\text{C}$			450	μV
Offset Voltage Drift	$\Delta V_{OS}/\Delta T$	$-40^\circ\text{C} \leq T_A \leq +125^\circ\text{C}$		1	900	$\mu\text{V}/^\circ\text{C}$
Input Bias Current	I_B	$-40^\circ\text{C} \leq T_A \leq +125^\circ\text{C}$		± 10	± 15	nA
					± 16	nA
Input Offset Current	I_{OS}	$-40^\circ\text{C} \leq T_A \leq +125^\circ\text{C}$		± 0.1	± 1.5	nA
					± 3	nA
Input Voltage Range			-1.5		+1.5	V
Common-Mode Rejection Ratio	CMRR	$V_{CM} = 0\text{ V to } \pm 1.5\text{ V}$	63	77		dB
		$-40^\circ\text{C} \leq T_A \leq +125^\circ\text{C}$	58			dB
Large Signal Voltage Gain	A_{VO}	$R_L = 10\text{ k}\Omega$, $V_O = -1.4\text{ V to } +1.4\text{ V}$	92	94		dB
		$-40^\circ\text{C} \leq T_A \leq +125^\circ\text{C}$	84			dB
		$R_L = 2\text{ k}\Omega$, $V_O = -1.3\text{ V to } +1.3\text{ V}$	86	92		dB
		$-40^\circ\text{C} \leq T_A \leq +125^\circ\text{C}$	77			dB
MATCHING CHARACTERISTICS						
Offset Voltage		$T_A = 25^\circ\text{C}$		100	300	μV
OUTPUT CHARACTERISTICS						
Output Voltage High	V_{OH}	$R_L = 10\text{ k}\Omega$ to GND	1.48	1.49		V
		$-40^\circ\text{C} \leq T_A \leq +125^\circ\text{C}$	1.45			V
		$R_L = 2\text{ k}\Omega$ to GND	1.45	1.46		V
		$-40^\circ\text{C to } +125^\circ\text{C}$	1.40			V
Output Voltage Low	V_{OL}	$R_L = 10\text{ k}\Omega$ to GND		-1.49	-1.48	V
		$-40^\circ\text{C} \leq T_A \leq +125^\circ\text{C}$			-1.45	V
		$R_L = 2\text{ k}\Omega$ to GND		-1.48	-1.47	V
		$-40^\circ\text{C} \leq T_A \leq +125^\circ\text{C}$			-1.40	V
Short-Circuit Limit	I_{SC}	Source/sink		± 10		mA
Closed-Loop Impedance	Z_{OUT}	$f = 100\text{ kHz}$, $A_V = 1$		102		Ω
POWER SUPPLY						
Power Supply Rejection Ratio	PSRR	$V_{SY} = 3\text{ V to } 36\text{ V}$	100			dB
		$-40^\circ\text{C} \leq T_A \leq +125^\circ\text{C}$	90			dB
Supply Current per Amplifier	I_{SY}	$V_O = V_{SY}/2$		40		μA
		$-40^\circ\text{C} \leq T_A \leq +125^\circ\text{C}$			80	μA
DYNAMIC PERFORMANCE						
Slew Rate	SR	$R_L = 100\text{ k}\Omega$, $C_L = 30\text{ pF}$		0.25		V/ μs
Gain Bandwidth Product	GBP	$V_{IN} = 5\text{ mV p-p}$, $R_L = 10\text{ k}\Omega$, $A_V = 100$		501		kHz
Unity-Gain Crossover	UGC	$V_{IN} = 5\text{ mV p-p}$, $R_L = 10\text{ k}\Omega$, $A_V = 1$		465		kHz
Phase Margin	Φ_M			51		Degrees
-3 dB Closed-Loop Bandwidth	-3 dB	$A_V = 1$, $V_{IN} = 5\text{ mV p-p}$		970		kHz
NOISE PERFORMANCE						
Voltage Noise	e_n p-p	0.1 Hz to 10 Hz		0.7		$\mu\text{V p-p}$
Voltage Noise Density	e_n	$f = 1\text{ kHz}$		27		nV/ $\sqrt{\text{Hz}}$
Current Noise Density	i_n	$f = 1\text{ kHz}$		0.2		pA/ $\sqrt{\text{Hz}}$

ELECTRICAL SPECIFICATIONS, $V_{SY} = \pm 5\text{ V}$

$V_{SY} = \pm 5.0\text{ V}$, $V_{CM} = V_{SY}/2$, $T_A = 25^\circ\text{C}$, unless otherwise noted.

Table 3.

Parameter	Symbol	Test Conditions/Comments	Min	Typ	Max	Unit
INPUT CHARACTERISTICS						
Offset Voltage	V_{OS}	$-40^\circ\text{C} \leq T_A \leq +125^\circ\text{C}$		35	300	μV
Offset Voltage Drift	$\Delta V_{OS}/\Delta T$			1	500	$\mu\text{V}/^\circ\text{C}$
Input Bias Current	I_B	$-40^\circ\text{C} \leq T_A \leq +125^\circ\text{C}$		± 10	± 15	nA
Input Offset Current	I_{OS}	$-40^\circ\text{C} \leq T_A \leq +125^\circ\text{C}$		± 1.5	± 2	nA
Input Voltage Range			-5		+5	V
Common-Mode Rejection Ratio	CMRR	$V_{CM} = -5\text{ V to }+5\text{ V}$ $-40^\circ\text{C} \leq T_A \leq +125^\circ\text{C}$	73	86		dB
		$V_{CM} = -3\text{ V to }+3\text{ V}$ $-40^\circ\text{C} \leq T_A \leq +125^\circ\text{C}$	68	103		dB
		$V_{CM} = -3\text{ V to }+3\text{ V}$ $-40^\circ\text{C} \leq T_A \leq +125^\circ\text{C}$	91	103		dB
		$V_{CM} = -3\text{ V to }+3\text{ V}$ $-40^\circ\text{C} \leq T_A \leq +125^\circ\text{C}$	85			dB
Large Signal Voltage Gain	A_{VO}	$R_L = 10\text{ k}\Omega$, $V_O = \pm 4.8\text{ V}$ $-40^\circ\text{C} \leq T_A \leq +125^\circ\text{C}$	102	111		dB
		$R_L = 2\text{ k}\Omega$, $V_O = \pm 4.7\text{ V}$ $-40^\circ\text{C} \leq T_A \leq +125^\circ\text{C}$	99			dB
		$R_L = 2\text{ k}\Omega$, $V_O = \pm 4.7\text{ V}$ $-40^\circ\text{C} \leq T_A \leq +125^\circ\text{C}$	94	103		dB
		$R_L = 2\text{ k}\Omega$, $V_O = \pm 4.7\text{ V}$ $-40^\circ\text{C} \leq T_A \leq +125^\circ\text{C}$	88			dB
MATCHING CHARACTERISTICS						
Offset Voltage		$T_A = 25^\circ\text{C}$		100	300	μV
OUTPUT CHARACTERISTICS						
Output Voltage High	V_{OH}	$R_L = 10\text{ k}\Omega$ to GND $-40^\circ\text{C} \leq T_A \leq +125^\circ\text{C}$	4.96	4.97		V
		$R_L = 2\text{ k}\Omega$ to GND $-40^\circ\text{C} \leq T_A \leq +125^\circ\text{C}$	4.95			V
		$R_L = 2\text{ k}\Omega$ to GND $-40^\circ\text{C} \leq T_A \leq +125^\circ\text{C}$	4.80	4.90		V
		$R_L = 2\text{ k}\Omega$ to GND $-40^\circ\text{C} \leq T_A \leq +125^\circ\text{C}$	4.70			V
Output Voltage Low	V_{OL}	$R_L = 10\text{ k}\Omega$ to GND $-40^\circ\text{C} \leq T_A \leq +125^\circ\text{C}$		-4.98	-4.97	V
		$R_L = 10\text{ k}\Omega$ to GND $-40^\circ\text{C} \leq T_A \leq +125^\circ\text{C}$			-4.95	V
		$R_L = 2\text{ k}\Omega$ to GND $-40^\circ\text{C} \leq T_A \leq +125^\circ\text{C}$		-4.90	-4.80	V
		$R_L = 2\text{ k}\Omega$ to GND $-40^\circ\text{C} \leq T_A \leq +125^\circ\text{C}$			-4.75	V
Short-Circuit Limit	I_{SC}	Source/sink		± 10		mA
Closed-Loop Impedance	Z_{OUT}	$f = 100\text{ kHz}$, $A_V = 1$		71		Ω
POWER SUPPLY						
Power Supply Rejection Ratio	PSRR	$V_{SY} = 3\text{ V to }36\text{ V}$ $-40^\circ\text{C} \leq T_A \leq +125^\circ\text{C}$	100			dB
			90			dB
Supply Current per Amplifier	I_{SY}	$V_O = V_{SY}/2$ $-40^\circ\text{C} \leq T_A \leq +125^\circ\text{C}$		47	55	μA
					75	μA
DYNAMIC PERFORMANCE						
Slew Rate	SR	$R_L = 100\text{ k}\Omega$, $C_L = 30\text{ pF}$		0.3		$\text{V}/\mu\text{s}$
Gain Bandwidth Product	GBP	$V_{IN} = 5\text{ mV p-p}$, $R_L = 10\text{ k}\Omega$, $A_V = 100$		595		kHz
Unity-Gain Crossover	UGC	$V_{IN} = 5\text{ mV p-p}$, $R_L = 10\text{ k}\Omega$, $A_V = 1$		550		kHz
Phase Margin	Φ_M			52		Degrees
-3 dB Closed-Loop Bandwidth	-3 dB	$A_V = 1$, $V_{IN} = 5\text{ mV p-p}$		1140		kHz
NOISE PERFORMANCE						
Voltage Noise	e_n p-p	0.1 Hz to 10 Hz		0.7		$\mu\text{V p-p}$
Voltage Noise Density	e_n	$f = 1\text{ kHz}$		27		$\text{nV}/\sqrt{\text{Hz}}$
Current Noise Density	i_n	$f = 1\text{ kHz}$		0.2		$\text{pA}/\sqrt{\text{Hz}}$

ELECTRICAL SPECIFICATIONS, $V_{SY} = \pm 15\text{ V}$

$V_{SY} = \pm 15.0\text{ V}$, $V_{CM} = V_{SY}/2$, $V_O = 0.0\text{ V}$, $T_A = 25^\circ\text{C}$, unless otherwise noted.

Table 4.

Parameter	Symbol	Test Conditions/Comments	Min	Typ	Max	Unit
INPUT CHARACTERISTICS						
Offset Voltage	V_{OS}	$-40^\circ\text{C} \leq T_A \leq +125^\circ\text{C}$		35	300	μV
Offset Voltage Drift	$\Delta V_{OS}/\Delta T$			1	500	$\mu\text{V}/^\circ\text{C}$
Input Bias Current	I_B	$-40^\circ\text{C} \leq T_A \leq +125^\circ\text{C}$		± 3	± 10	nA
Input Offset Current	I_{OS}	$-40^\circ\text{C} \leq T_A \leq +125^\circ\text{C}$		± 0.1	± 1.5	nA
Input Voltage Range			-15		± 3	V
Common-Mode Rejection Ratio	CMRR	$V_{CM} = -15\text{ V to } +15\text{ V}$ $-40^\circ\text{C} \leq T_A \leq +125^\circ\text{C}$	82	95		dB
		$V_{CM} = -13\text{ V to } +13\text{ V}$ $-40^\circ\text{C} \leq T_A \leq +125^\circ\text{C}$	75	107		dB
Large Signal Voltage Gain	A_{VO}	$R_L = 10\text{ k}\Omega$, $V_O = \pm 14.7\text{ V}$ $-40^\circ\text{C} \leq T_A \leq +125^\circ\text{C}$	110	120		dB
		$R_L = 2\text{ k}\Omega$, $V_O = \pm 11\text{ V}$ $-40^\circ\text{C} \leq T_A \leq +125^\circ\text{C}$	105	112		dB
Input Capacitance						
Differential Mode	C_{DM}			2.5		pF
Common Mode	C_{CM}			7		pF
MATCHING CHARACTERISTICS						
Offset Voltage		$T_A = 25^\circ\text{C}$		100	300	μV
OUTPUT CHARACTERISTICS						
Output Voltage High	V_{OH}	$R_L = 10\text{ k}\Omega$ to GND $-40^\circ\text{C} \leq T_A \leq +125^\circ\text{C}$	14.92	14.94		V
		$R_L = 2\text{ k}\Omega$ to GND $-40^\circ\text{C} \leq T_A \leq +125^\circ\text{C}$	14.90	14.3		V
Output Voltage Low	V_{OL}	$R_L = 10\text{ k}\Omega$ to GND $-40^\circ\text{C} \leq T_A \leq +125^\circ\text{C}$	14.0	-14.96	-14.80	V
		$R_L = 2\text{ k}\Omega$ to GND $-40^\circ\text{C} \leq T_A \leq +125^\circ\text{C}$	12.0	-14.75	-14.65	V
Short-Circuit Limit	I_{SC}	Source/sink $-40^\circ\text{C} \leq T_A \leq +125^\circ\text{C}$		± 10	-14.0	mA
Closed-Loop Impedance	Z_{OUT}	$f = 100\text{ kHz}$, $A_V = 1$		40		Ω
POWER SUPPLY						
Power Supply Rejection Ratio	PSRR	$V_{SY} = 3\text{ V to } 36\text{ V}$ $-40^\circ\text{C} \leq T_A \leq +125^\circ\text{C}$	100			dB
			90			dB
Supply Current per Amplifier	I_{SY}	$V_O = V_{SY}/2$ $-40^\circ\text{C} \leq T_A \leq +125^\circ\text{C}$		60	75	μA
					100	μA
DYNAMIC PERFORMANCE						
Slew Rate	SR	$R_L = 100\text{ k}\Omega$, $C_L = 30\text{ pF}$		0.4		V/ μs
Settling Time	t_s	To 0.1%, 10 V step		23.4		μs
Gain Bandwidth Product	GBP	$V_{IN} = 5\text{ mV p-p}$, $R_L = 10\text{ k}\Omega$, $A_V = 100$		786		kHz
Unity-Gain Crossover	UGC	$V_{IN} = 5\text{ mV p-p}$, $R_L = 10\text{ k}\Omega$, $A_V = 1$		800		kHz
Phase Margin	Φ_M			60		Degrees
-3 dB Closed-Loop Bandwidth	-3 dB	$A_V = 1$, $V_{IN} = 5\text{ mV p-p}$		1520		kHz
Channel Separation	CS	$f = 1\text{ kHz}$		100		dB

Parameter	Symbol	Test Conditions/Comments	Min	Typ	Max	Unit
NOISE PERFORMANCE						
Voltage Noise	e_n p-p	0.1 Hz to 10 Hz		0.7		$\mu\text{V p-p}$
Voltage Noise Density	e_n	$f = 1 \text{ kHz}$		27		$\text{nV}/\sqrt{\text{Hz}}$
Current Noise Density	i_n	$f = 1 \text{ kHz}$		0.2		$\text{pA}/\sqrt{\text{Hz}}$

ABSOLUTE MAXIMUM RATINGS

Table 5.

Parameter	Rating
Supply Voltage	36 V
Input Voltage	
Operating Condition	$-V \leq V_{IN} \leq +V$
Overvoltage Condition ¹	$(-V) - 32V \leq V_{IN} \leq (+V) + 32V$
Differential Input Voltage ²	$\pm V_{SY}$
Input Current	± 5 mA
Output Short-Circuit Duration to GND	Indefinite
Storage Temperature Range	-65°C to $+150^{\circ}\text{C}$
Operating Temperature Range	-40°C to $+125^{\circ}\text{C}$
Junction Temperature Range	-65°C to $+150^{\circ}\text{C}$
Lead Temperature (Soldering, 60 sec)	300°C

¹ Performance not guaranteed during overvoltage conditions.

² Limit the input current to ± 5 mA.

Stresses above those listed under Absolute Maximum Ratings may cause permanent damage to the device. This is a stress rating only; functional operation of the device at these or any other conditions above those indicated in the operational section of this specification is not implied. Exposure to absolute maximum rating conditions for extended periods may affect device reliability.

THERMAL RESISTANCE

θ_{JA} is specified for the device soldered on a 4-layer JEDEC standard printed circuit board (PCB) with zero airflow. The exposed pad is soldered to the application board.

Table 6. Thermal Resistance

Package Type	θ_{JA}	θ_{JC}	Unit
8-Lead MSOP (RM-8)	142	45	$^{\circ}\text{C}/\text{W}$
8-Lead LFCSP (CP-8-10)	76	43	$^{\circ}\text{C}/\text{W}$

ESD CAUTION



ESD (electrostatic discharge) sensitive device.

Charged devices and circuit boards can discharge without detection. Although this product features patented or proprietary protection circuitry, damage may occur on devices subjected to high energy ESD. Therefore, proper ESD precautions should be taken to avoid performance degradation or loss of functionality.

TYPICAL PERFORMANCE CHARACTERISTICS

T_A = 25°C, unless otherwise noted.

±1.5 V CHARACTERISTICS

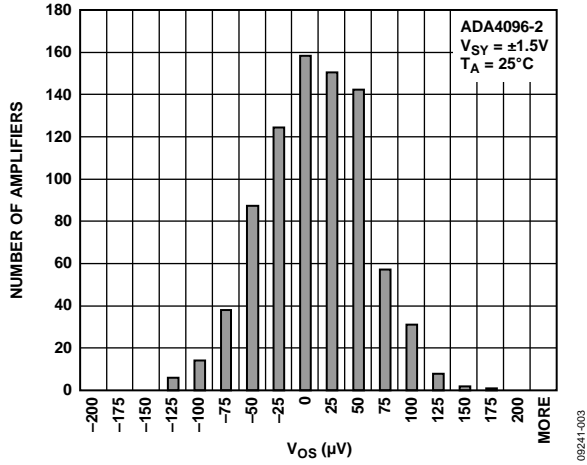

Figure 3. Input Offset Voltage Distribution

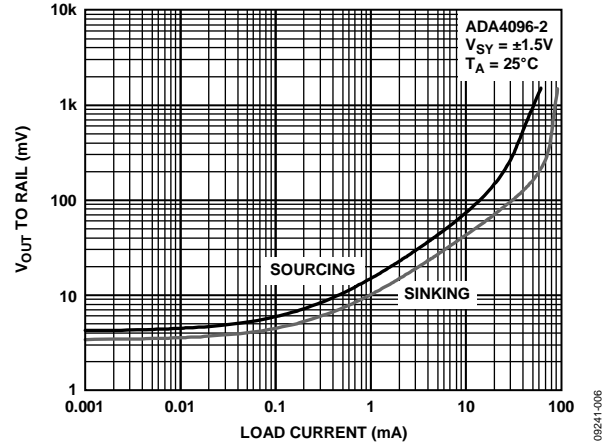

Figure 6. Dropout Voltage vs. Load Current

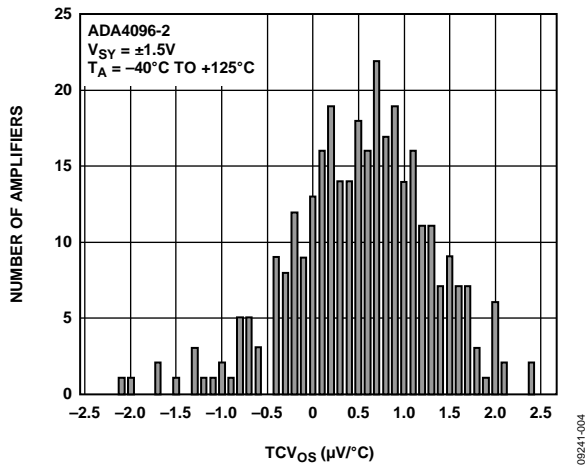

Figure 4. Offset Voltage Drift Distribution

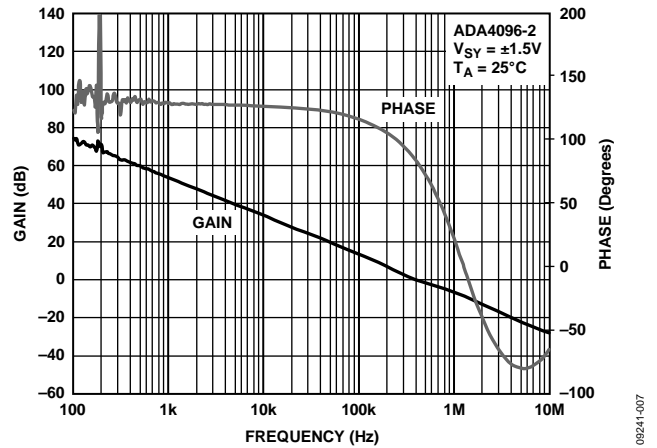

Figure 7. Open-Loop Gain and Phase vs. Frequency

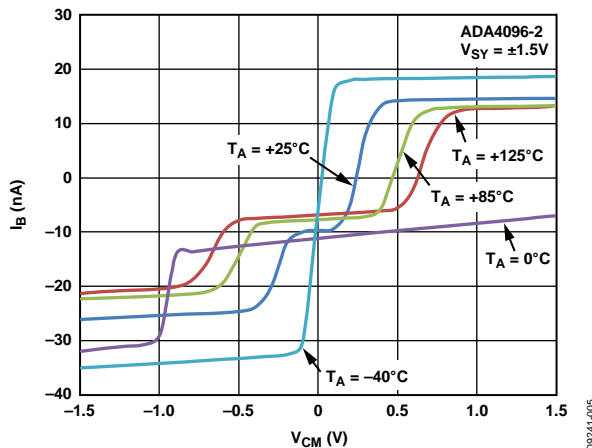

Figure 5. Input Bias Current vs. V_{CM} and Temperature

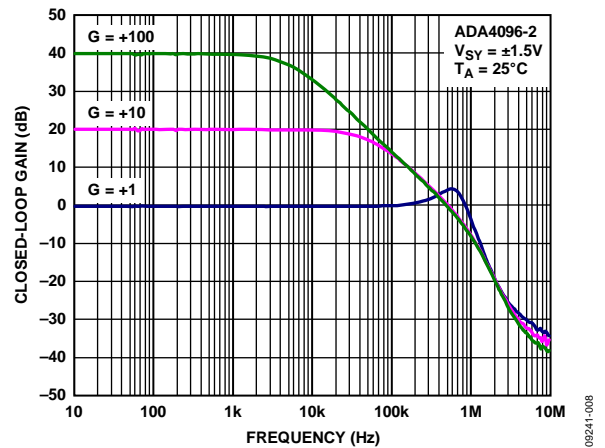

Figure 8. Closed-Loop Gain vs. Frequency

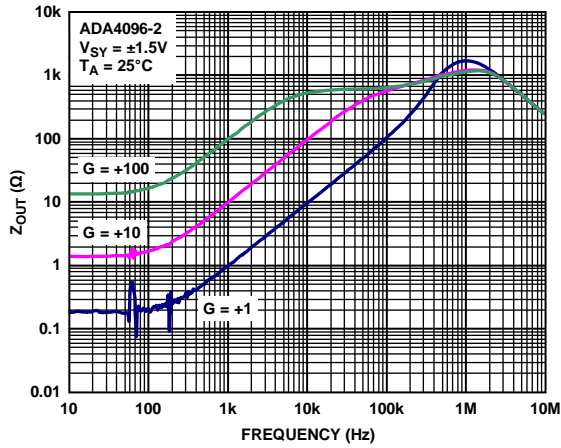

Figure 9. Output Impedance vs. Frequency

09241-009

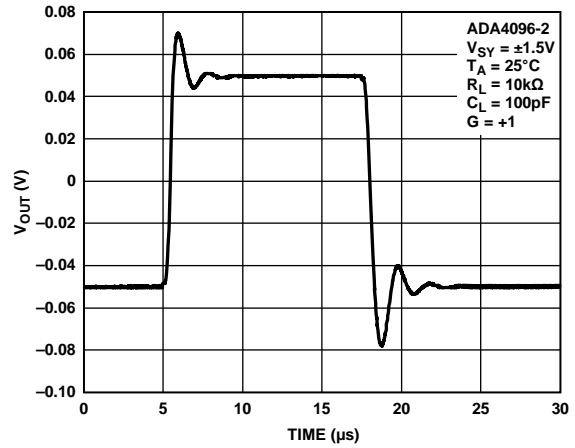

Figure 12. Small Signal Transient Response

09241-011

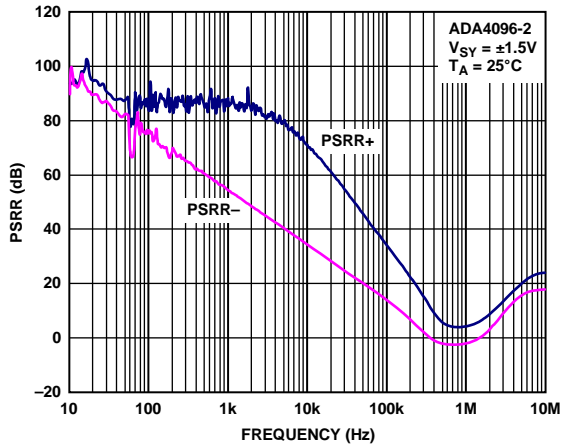

Figure 10. PSRR vs. Frequency

09241-052

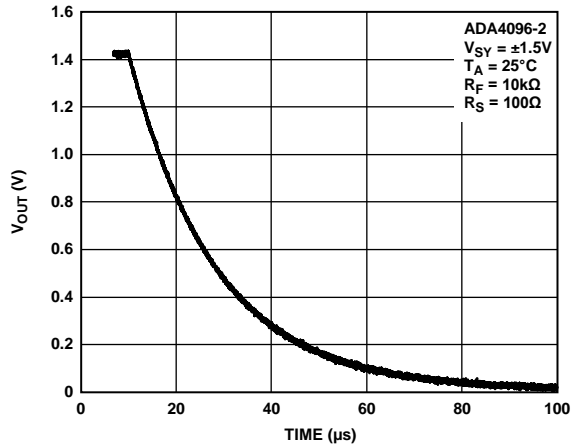

Figure 13. Positive Overload Recovery

09241-055

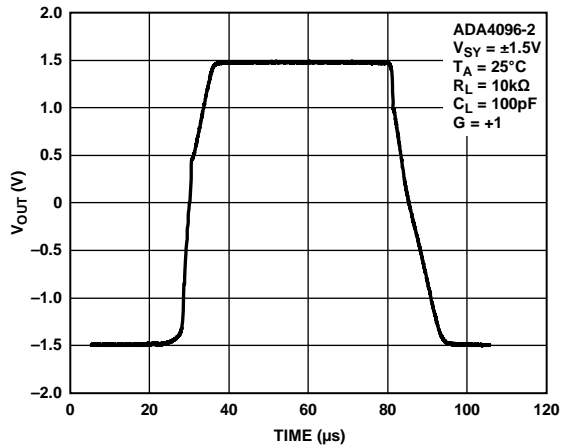

Figure 11. Large Signal Transient Response

09241-010

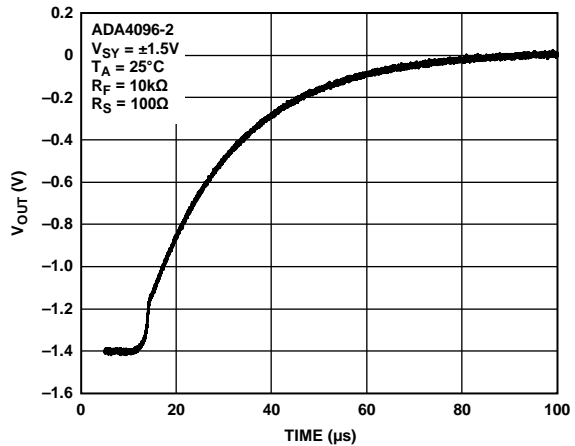

Figure 14. Negative Overload Recovery

09241-056

±5 V CHARACTERISTICS

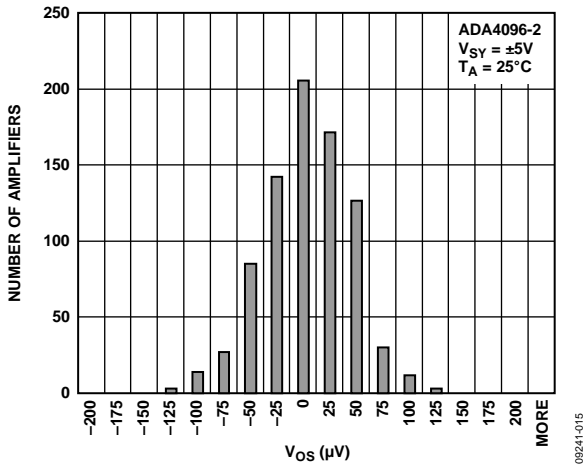

Figure 15. Input Offset Voltage Distribution

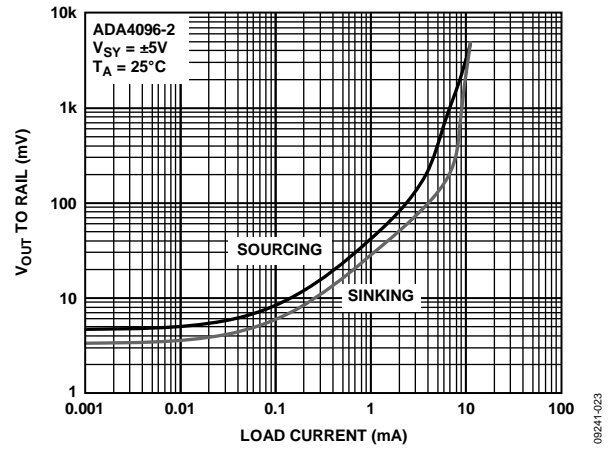

Figure 18. Dropout Voltage vs. Load Current

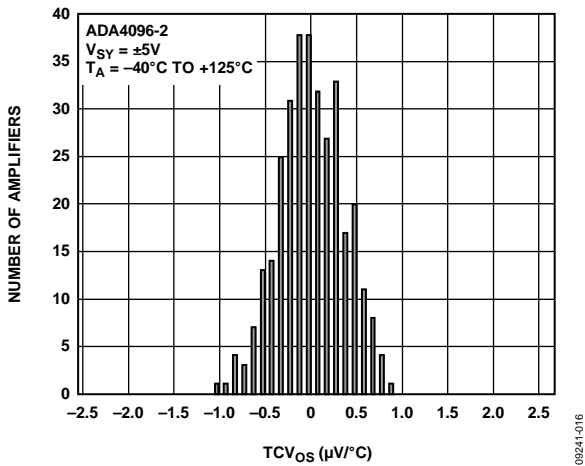

Figure 16. Offset Voltage Drift Distribution

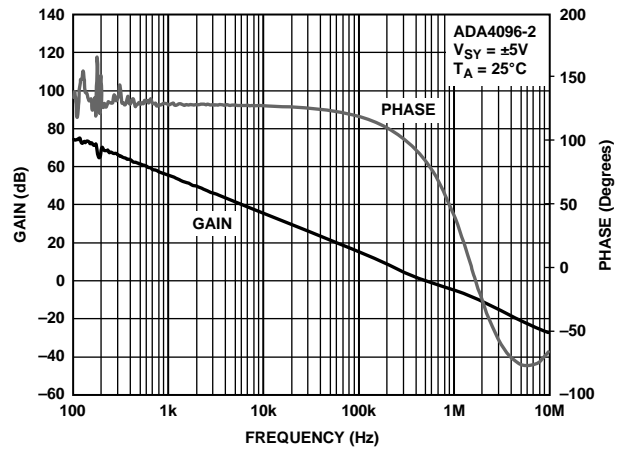

Figure 19. Open-Loop Gain and Phase vs. Frequency

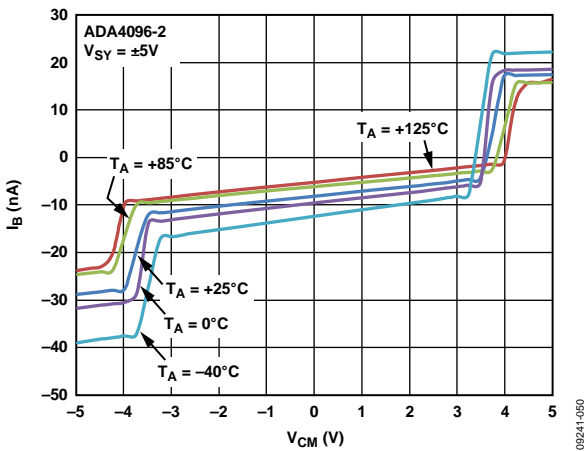

Figure 17. Input Bias Current vs. V_{CM} and Temperature

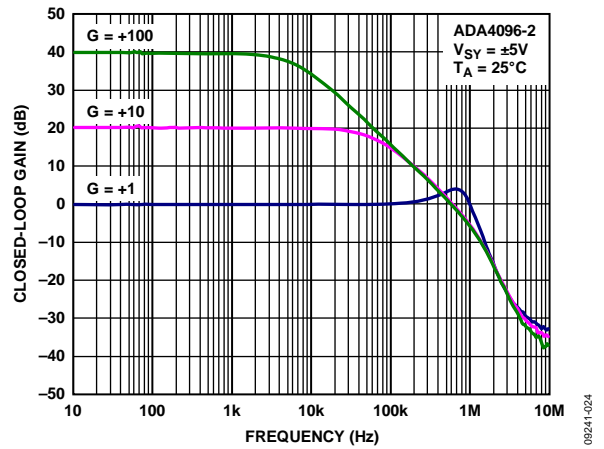

Figure 20. Closed-Loop Gain vs. Frequency

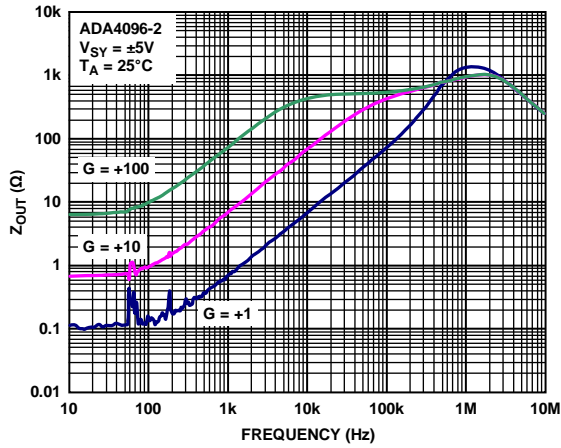

Figure 21. Output Impedance vs. Frequency

09241-021

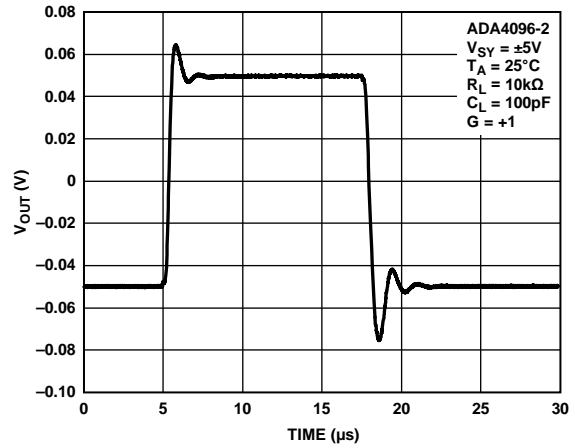

Figure 24. Small Signal Transient Response

09241-018

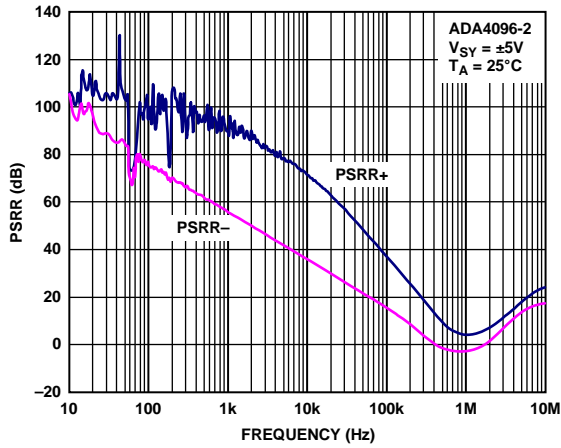

Figure 22. PSRR vs. Frequency

09241-053

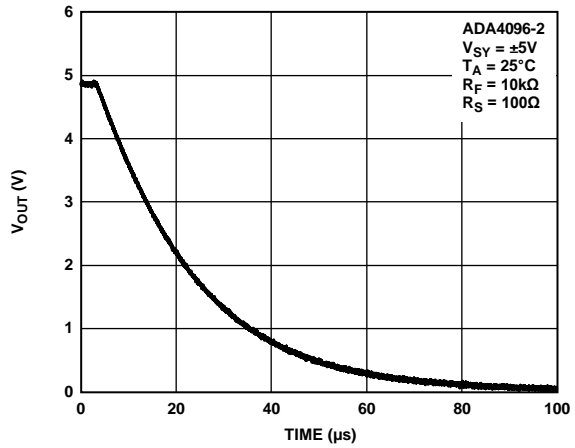

Figure 25. Positive Overload Recovery

09241-057

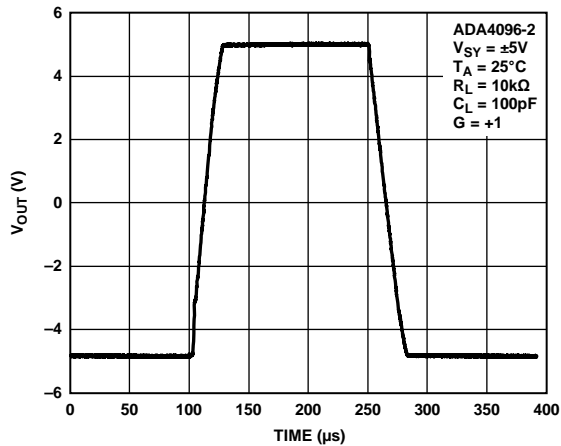

Figure 23. Large Signal Transient Response

09241-017

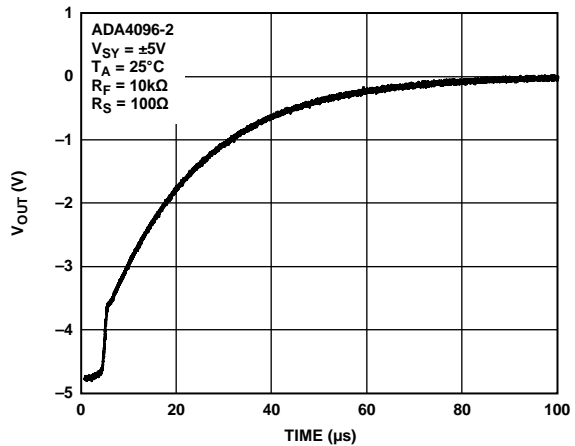

Figure 26. Negative Overload Recovery

09241-058

±15 V CHARACTERISTICS

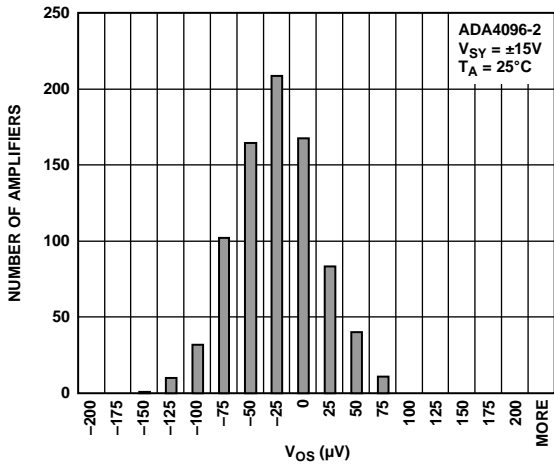

Figure 27. Input Offset Voltage Distribution

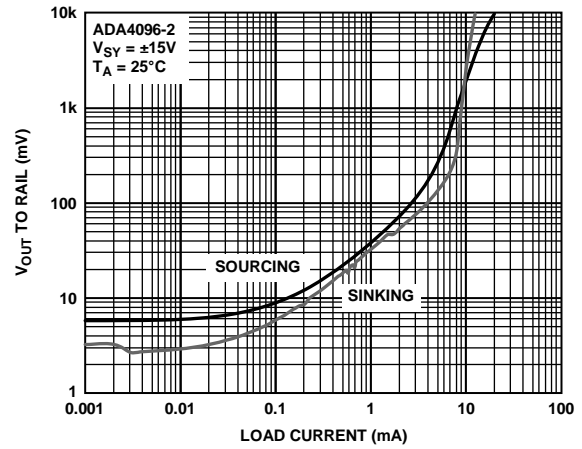

Figure 30. Dropout Voltage vs. Load Current

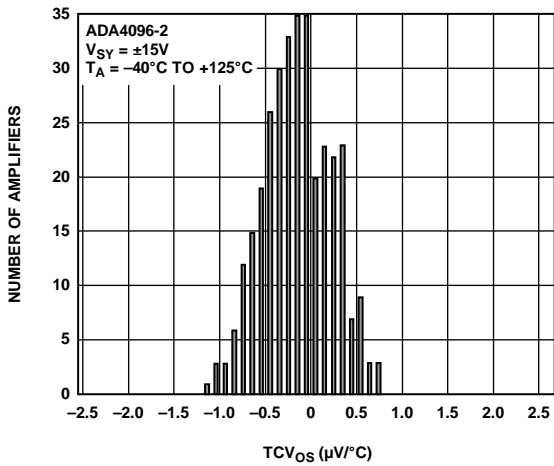

Figure 28. Offset Voltage Drift Distribution

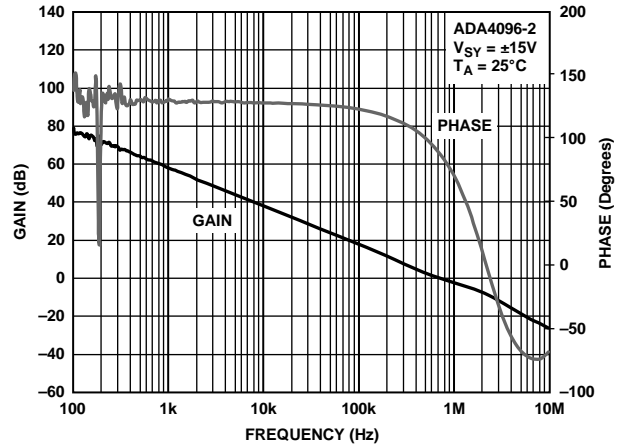

Figure 31. Open-Loop Gain and Phase vs. Frequency

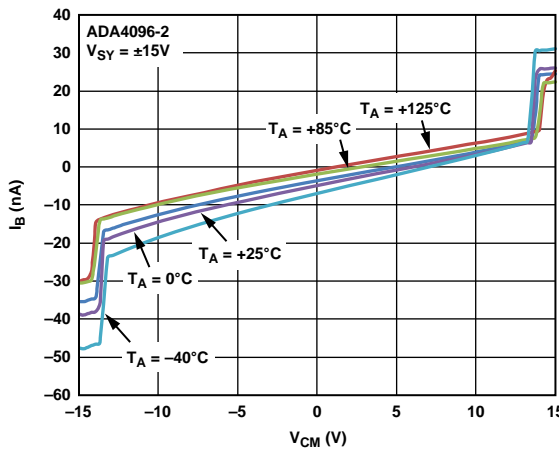

Figure 29. Input Bias Current vs. V_{CM} and Temperature

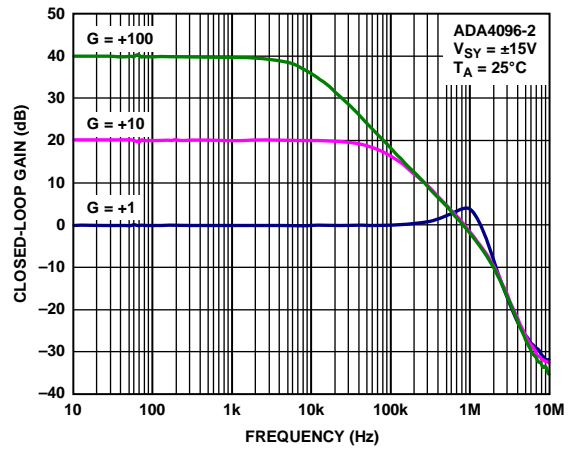

Figure 32. Closed-Loop Gain vs. Frequency

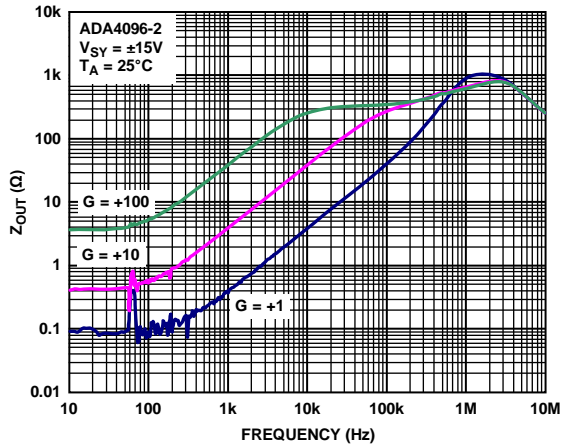

Figure 33. Output Impedance vs. Frequency

09241-035

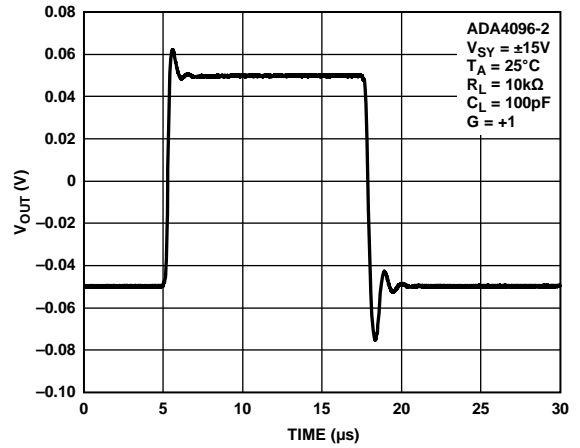

Figure 36. Small Signal Transient Response

09241-032

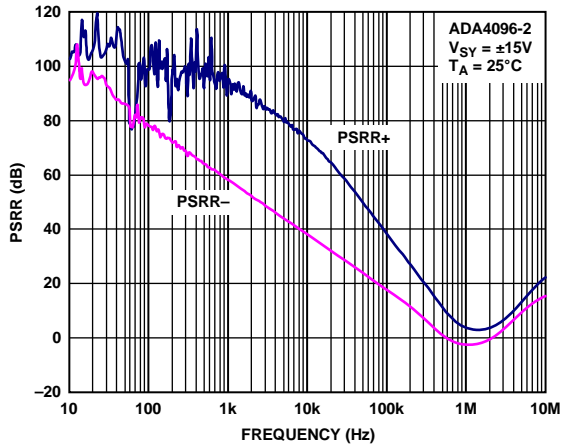

Figure 34. PSRR vs. Frequency

09241-054

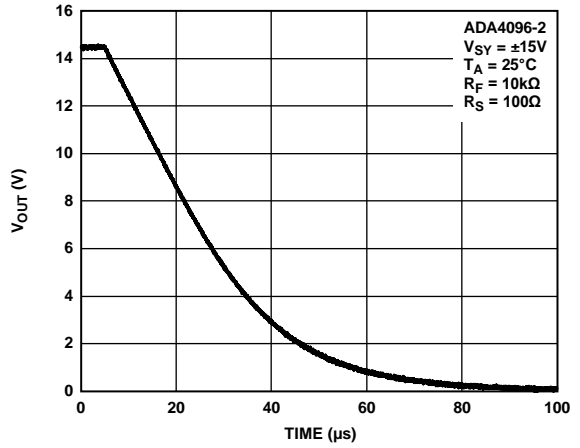

Figure 37. Positive Overload Recovery

09241-059

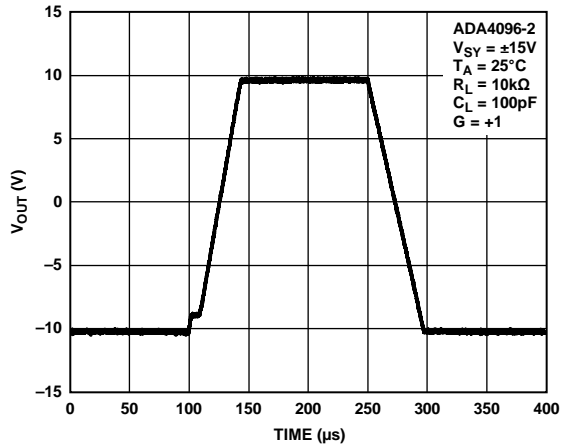

Figure 35. Large Signal Transient Response

09241-031

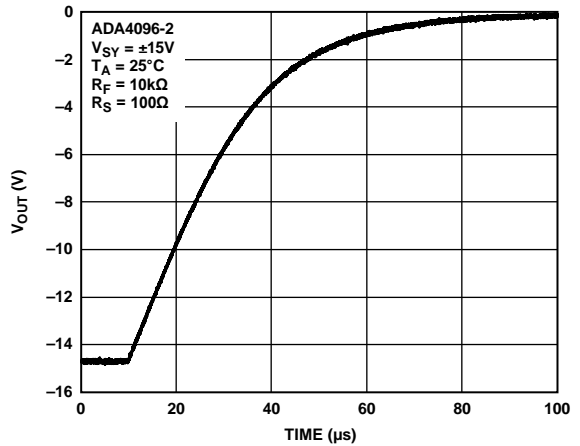

Figure 38. Negative Overload Recovery

09241-060

COMPARATIVE VOLTAGE AND VARIABLE VOLTAGE GRAPHS

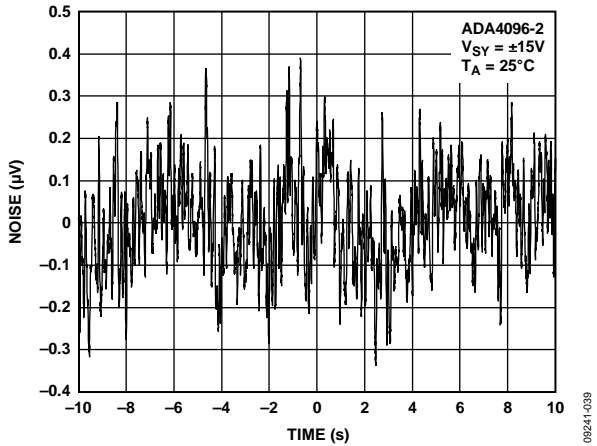

Figure 39. Input Voltage Noise, 0.1 Hz to 10 Hz Bandwidth

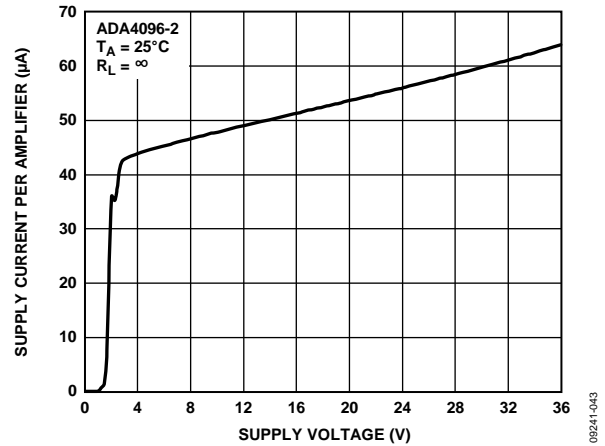

Figure 42. Supply Current vs. Supply Voltage

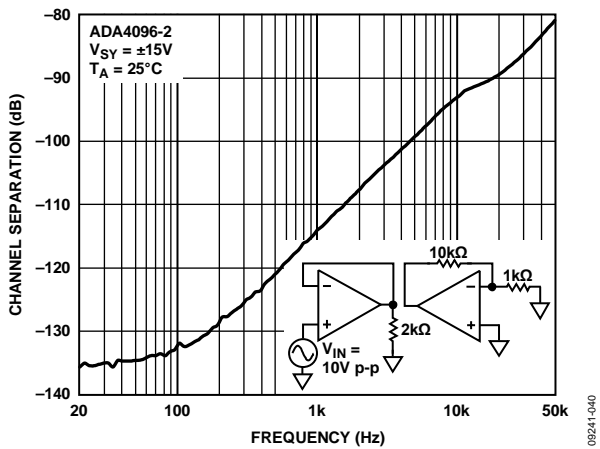

Figure 40. Channel Separation vs. Frequency

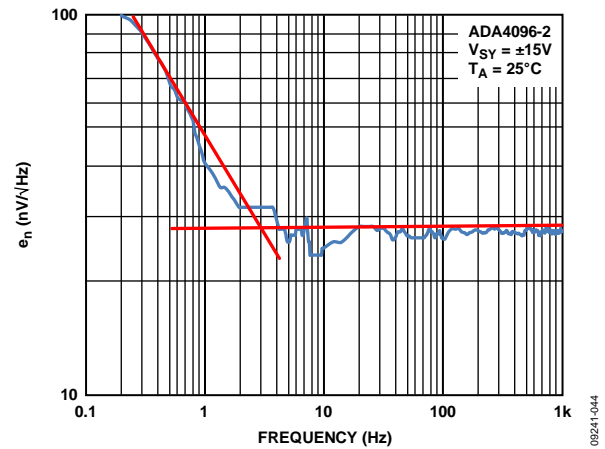

Figure 43. Voltage Noise Density

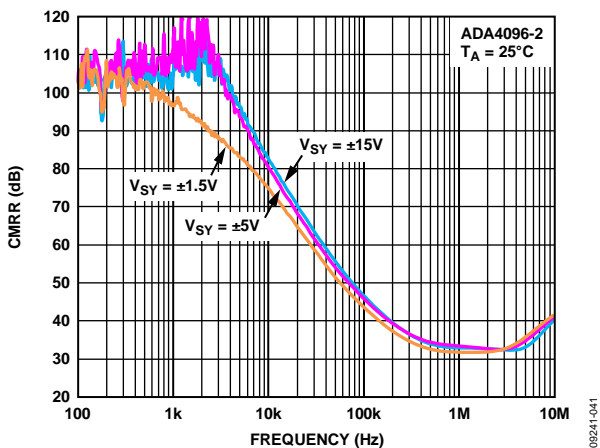

Figure 41. CMRR vs. Frequency

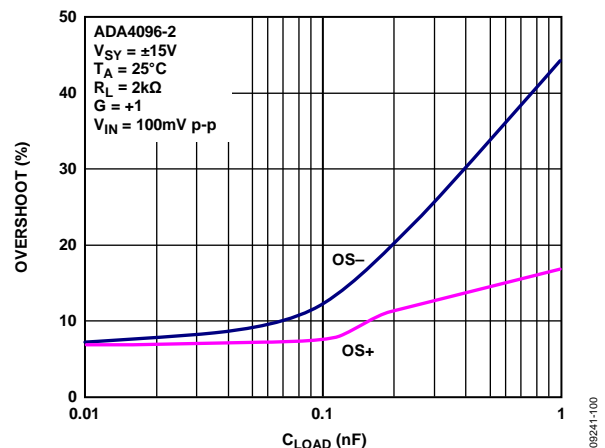

Figure 44. Overshoot vs. Load Capacitance

THEORY OF OPERATION

INPUT STAGE

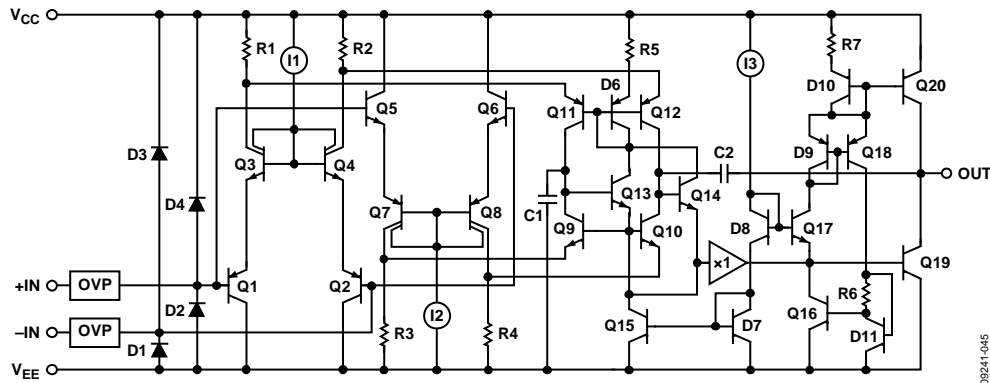

Figure 45. Simplified Schematic

Figure 45 shows a simplified schematic of the ADA4096-2. The input stage comprises two differential pairs (Q1 to Q4 and Q5 to Q8) operating in parallel. When the input common-mode voltage approaches $V_{CC} - 1.5\text{ V}$, Q1 to Q4 shut down as I1 reaches its minimum voltage compliance. Conversely, when the input common-mode voltage approaches $V_{EE} + 1.5\text{ V}$, Q5 to Q8 shut down as I2 reaches its minimum voltage compliance. This topology allows for maximum input dynamic range because the amplifier can function with its inputs at 200 mV outside the rail (at room temperature).

As with any rail-to-rail input amplifier, V_{OS} mismatch between the two input pairs determines the CMRR of the amplifier. If the input common-mode voltage range is kept within 1.5 V of each rail, transitions between the input pairs are avoided, thus improving the CMRR by approximately 10 dB (see Table 3 and Table 4).

PHASE INVERSION

Some single-supply amplifiers exhibit phase inversion when the input signal extends beyond the common-mode voltage range of the amplifier. When the input devices become saturated, the inverting and noninverting inputs exchange functions, causing the output to move in the opposing direction.

Although phase inversion persists for only as long as the inputs are saturated, it can be detrimental to applications where the amplifier is part of a closed-loop system. The ADA4096-2 is free from phase inversion over the entire common-mode voltage range, as well as the overvoltage protected range stated in the Absolute Maximum Ratings section, Table 5. Figure 46 shows the ADA4096-2 in a unity-gain configuration with the input signal at $\pm 40\text{ V}$ and the amplifier supplies at $\pm 10\text{ V}$.

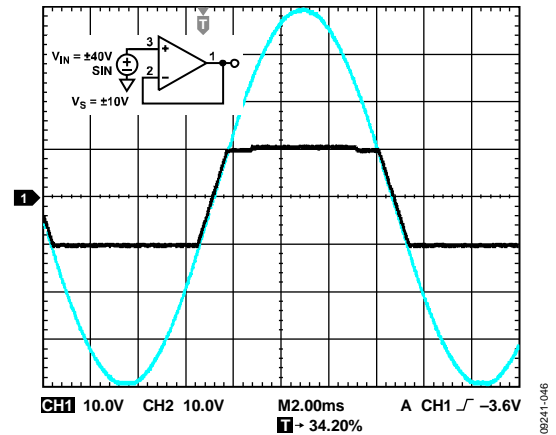

Figure 46. No Phase Reversal

INPUT OVERVOLTAGE PROTECTION

The ADA4096-2 inputs are protected from input voltage excursions up to 32 V outside each rail. This feature is of particular importance in applications with power supply sequencing issues that could cause the signal source to be active before the supplies to the amplifier.

Figure 47 shows the input current limiting capability of the ADA4096-2 (green curves) compared to using a 5 kΩ series resistor (red curves).

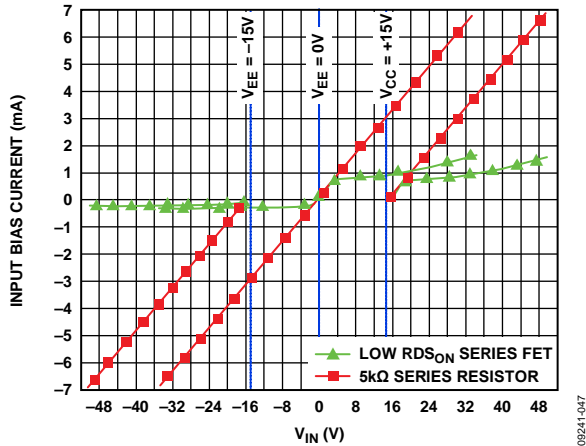

Figure 47. Input Current Limiting Capability

Figure 47 was generated with the ADA4096-2 in a buffer configuration with the supplies connected to GND (or ±15 V) and the positive input swept until it exceeds the supplies by 32 V. In general, input current is limited to 1 mA during positive overvoltage conditions and 200 μA during negative undervoltage conditions. For example, at an overvoltage of 20 V, the ADA4096-2 input current is limited to 1 mA, providing a current limit equivalent to a series 20 kΩ resistor. Figure 47 also shows that the current limiting circuitry is active whether the amplifier is powered or not.

Note that Figure 47 represents input protection under abnormal conditions only. The correct amplifier operation input voltage range (IVR) is specified in Table 2 to Table 4.

COMPARATOR OPERATION

Although op amps are quite different from comparators, occasionally an unused section of a dual or a quad op amp may be pressed into service as a comparator; however, this is not recommended for any rail-to-rail output op amps. For rail-to-rail output op amps, the output stage is generally a ratioed current mirror with bipolar or MOSFET transistors. With the part operating open loop, the second stage increases the current drive to the ratioed mirror to close the loop, but it cannot, which results in an increase in supply current. With the op amp configured as a comparator, the supply current can be significantly higher (see Figure 48).

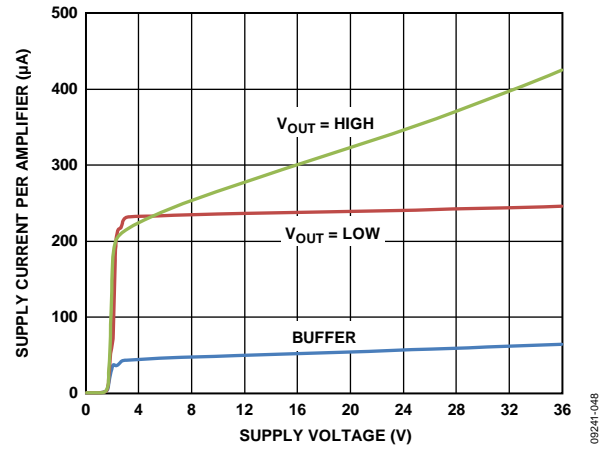
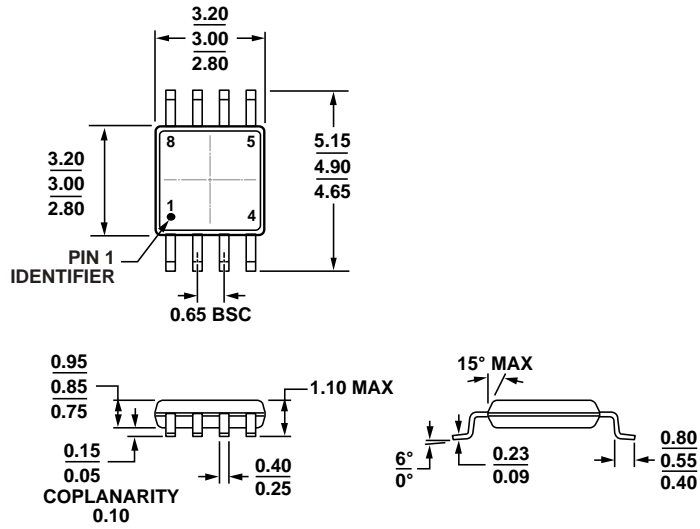

Figure 48. Comparator Supply Current

095241-0-08

OUTLINE DIMENSIONS



10-07-2005-B

COMPLIANT TO JEDEC STANDARDS MO-187-AA

Figure 49. 8-Lead Mini Small Outline Package [MSOP] (RM-8)

Dimensions shown in millimeters

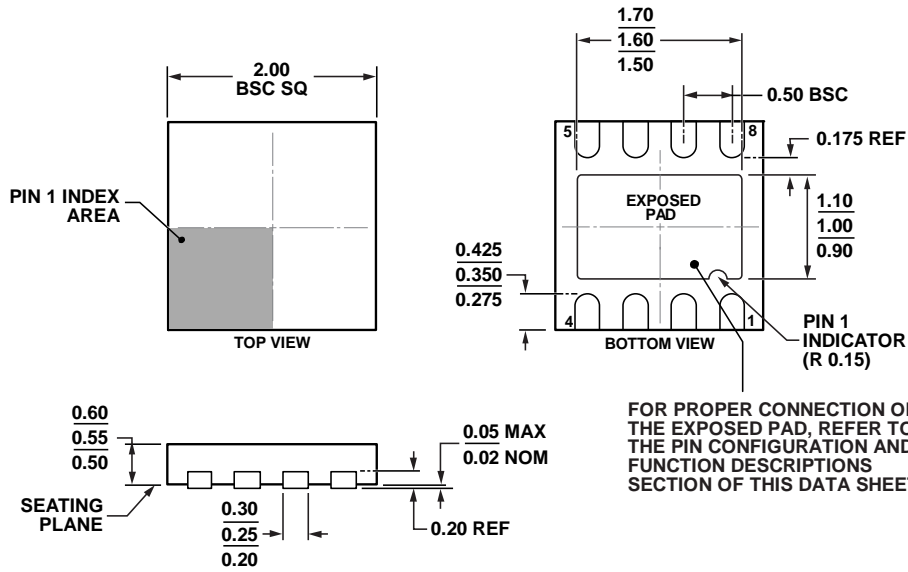

07-11-2011-B

Figure 50. 8-Lead Lead Frame Chip Scale Package [LFCSF_UD] 2 mm x 2 mm Body, Ultra Thin, Dual Lead (CP-8-10)

Dimensions shown in millimeters

ORDERING GUIDE

Model ^{1, 2}	Temperature Range	Package Description	Package Option	Branding
ADA4096-2ARMZ	-40°C to +125°C	8-Lead Mini Small Outline Package [MSOP]	RM-8	A2T
ADA4096-2ARMZ-R7	-40°C to +125°C	8-Lead Mini Small Outline Package [MSOP]	RM-8	A2T
ADA4096-2ARMZ-RL	-40°C to +125°C	8-Lead Mini Small Outline Package [MSOP]	RM-8	A2T
ADA4096-2ACPZ-R7	-40°C to +125°C	8-Lead Frame Chip Scale Package [LFCSP_UD]	CP-8-10	A4
ADA4096-2ACPZ-RL	-40°C to +125°C	8-Lead Frame Chip Scale Package [LFCSP_UD]	CP-8-10	A4
ADA4096-2WARMZ-R7	-40°C to +125°C	8-Lead Mini Small Outline Package [MSOP]	RM-8	A2T
ADA4096-2WARMZ-RL	-40°C to +125°C	8-Lead Mini Small Outline Package [MSOP]	RM-8	A2T

¹ Z = RoHS Compliant Part.

² W = Qualified for Automotive Applications.

AUTOMOTIVE PRODUCTS

The ADA4096-2W models are available with controlled manufacturing to support the quality and reliability requirements of automotive applications. Note that these automotive models may have specifications that differ from the commercial models; therefore, designers should review the Specifications section of this data sheet carefully. Only the automotive grade products shown are available for use in automotive applications. Contact your local Analog Devices account representative for specific product ordering information and to obtain the specific Automotive Reliability reports for these models.

NOTES