

G8050

NPN EPITAXIAL TRANSISTOR

Description

The G8050 is designed for use in 2W output amplifier of portable radios in class B push-pull operation.

Features

*High Collector current (IC: 1.5A)

*Complementary to G8550

Package Dimensions

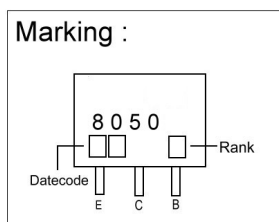
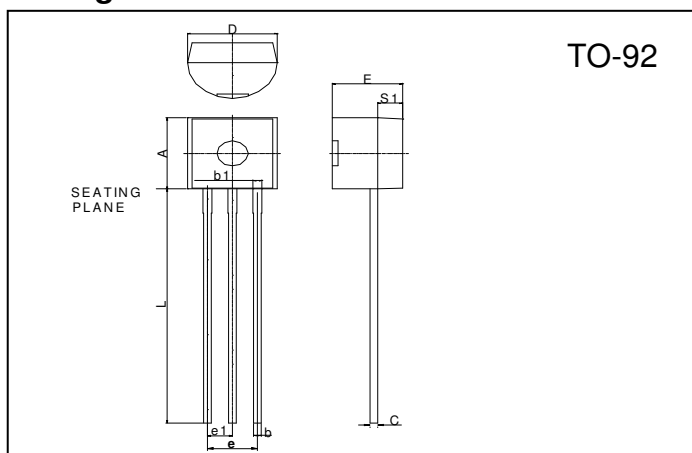

REF.	Millimeter		REF.	Millimeter	
	Min.	Max.		Min.	Max.
A	4.45	4.7	D	4.44	4.7
S1	1.02	-	E	3.30	3.81
b	0.36	0.51	L	12.70	-
b1	0.36	0.76	e1	1.150	1.390
C	0.36	0.51	e	2.42	2.66

Absolute Maximum Ratings (Ta = 25°C, unless otherwise specified)

Parameter	Symbol	Ratings	Unit
Collector to Base Voltage	VCBO	40	V
Collector to Emitter Voltage	VCEO	25	V
Emitter to Base Voltage	VEBO	6	V
Collect Current	IC	1.5	A
Base Current	IB	0.5	A
Junction Temperature	Tj	+150	°C
Storage Temperature Range	TSTG	-55 ~ +150	°C
Total Power Dissipation	PD	1	W

Electrical Characteristics (Ta = 25°C, unless otherwise specified)

Symbol	Min.	Typ.	Max.	Unit	Test Conditions
BVCBO	40	-	-	V	IC=100uA
BVCEO	25	-	-	V	IC=2mA
BVEBO	6	-	-	V	IE=100uA
ICBO	-	-	100	nA	VCB=35V
IEBO	-	-	100	nA	VBE=6V
*VCE(sat)	-	-	0.5	V	IC=800mA, IB=80mA
*VBE(sat)	-	-	1.2	V	IC=800mA, IB=80mA
*VBE(on)	-	-	1	V	VCE=1V, IC=10mA
*hFE1	45	-	-		VCE=1V, IC=5mA
*hFE2	120	-	500		VCE=1V, IC=100mA
*hFE3	40	-	-		VCE=1V, IC=800mA
fT	100	-	-	MHz	VCE=10V, IC=50mA, f=100MHz
Cob	-	9	-	pF	VCB=10V, IE=0, f=1MHz

* Pulse Test: Pulse Width ≤ 380μs, Duty Cycle ≤ 2%

Classification Of hFE2

Rank	C	D	E
Range	120 ~ 200	160 ~ 320	250 ~ 500

Characteristics Curve

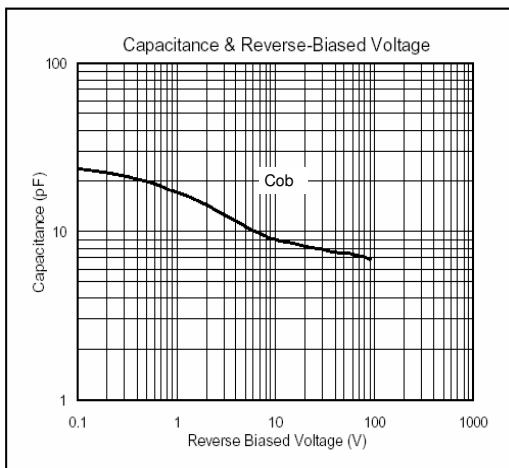
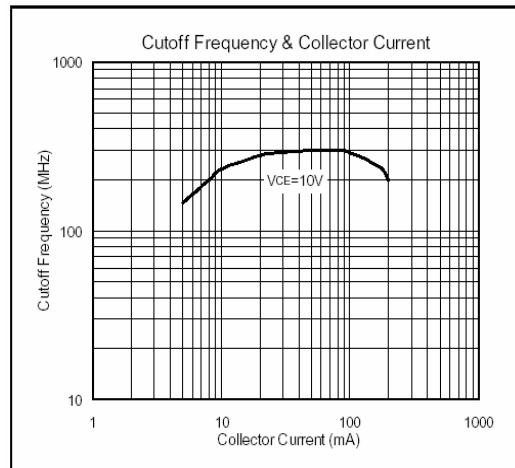
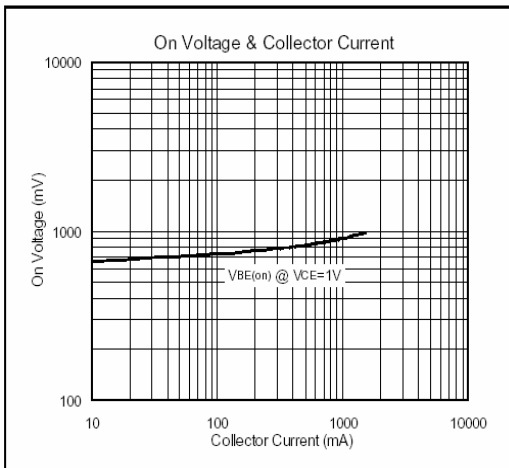
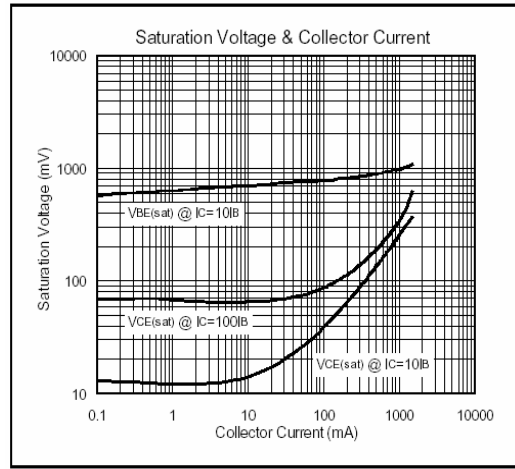
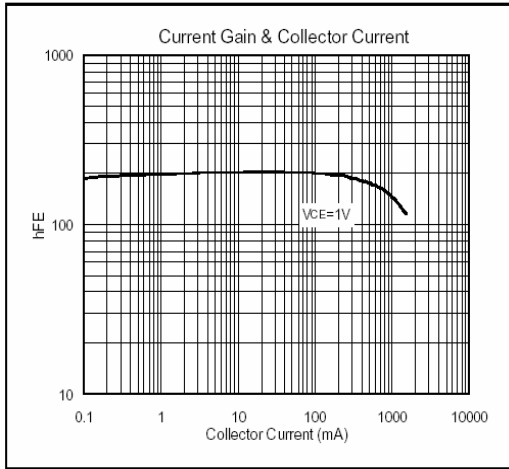

Important Notice:

- All rights are reserved. Reproduction in whole or in part is prohibited without the prior written approval of GTM.
- GTM reserves the right to make changes to its products without notice.
- GTM semiconductor products are not warranted to be suitable for use in life-support Applications, or systems.
- GTM assumes no liability for any consequence of customer product design, infringement of patents, or application assistance.

Head Office And Factory:

- **Taiwan:** No. 17-1 Tatung Rd. Fu Kou Hsin-Chu Industrial Park, Hsin-Chu, Taiwan, R. O. C.
- TEL : 886-3-597-7061 FAX : 886-3-597-9220, 597-0785
- **China:** (201203) No.255, Jang-Jiang Tsai-Lueng RD. , Pu-Dung-Hsin District, Shang-Hai City, China
- TEL : 86-21-5895-7671 ~ 4 FAX : 86-21-38950165