



SANYO Semiconductors

DATA SHEET

An ON Semiconductor Company

LV4912GP — Bi-CMOS LSI Class-D Audio Power Amplifier BTL 2W×1ch

Overview

The LV4912GP is analog input type digital power amplifier with 2W × 1 channel. By using an original feed back technology, it improves sound quality through it is class-D power amplifier and the LC filter in the output stage can be deleted as application.

Features

- Enabling output LC filter-less.
- Class-D amplifier system of the output BTL type.
- Improve the sound quality by the use of original feedback technology.
- Realized high efficiency class-D amplifier.
- Reduce the pop sound at ON/OFF state by the use of soft mute function.
- Full complement of built-in protection circuits : over current protection, thermal protection, and low power supply voltage protection circuits.
- Internal oscillation frequency : 280kHz

Functions

- Output power : 2W(V_D = 5V, R_L = 4Ω, THD + N = 10%)
- THD + N : 0.4% (V_D = 5V, R_L = 4Ω, fin = 1kHz, P_O = 1W, Filter : AES17)
- Noise : 70μVrms (Filter : DIN AUDIO)
- Package : VCT24 (3.5 × 3.5)

■ Any and all SANYO Semiconductor Co.,Ltd. products described or contained herein are, with regard to "standard application", intended for the use as general electronics equipment (home appliances, AV equipment, communication device, office equipment, industrial equipment etc.). The products mentioned herein shall not be intended for use for any "special application" (medical equipment whose purpose is to sustain life, aerospace instrument, nuclear control device, burning appliances, transportation machine, traffic signal system, safety equipment etc.) that shall require extremely high level of reliability and can directly threaten human lives in case of failure or malfunction of the product or may cause harm to human bodies, nor shall they grant any guarantee thereof. If you should intend to use our products for applications outside the standard applications of our customer who is considering such use and/or outside the scope of our intended standard applications, please consult with us prior to the intended use. If there is no consultation or inquiry before the intended use, our customer shall be solely responsible for the use.

■ Specifications of any and all SANYO Semiconductor Co.,Ltd. products described or contained herein stipulate the performance, characteristics, and functions of the described products in the independent state, and are not guarantees of the performance, characteristics, and functions of the described products as mounted in the customer's products or equipment. To verify symptoms and states that cannot be evaluated in an independent device, the customer should always evaluate and test devices mounted in the customer's products or equipment.

SANYO Semiconductor Co., Ltd.

<http://semicon.sanyo.com/en/network>

LV4912GP

Specifications

Maximum Ratings at $T_a = 25^\circ\text{C}$

Parameter	Symbol	Conditions	Ratings	Unit
Maximum supply voltage	VD	Externally applied voltage	6	V
Allowable power dissipation	Pd max	Mounted on a board *	1	W
Operating temperature	Topr		-20 to +75	$^\circ\text{C}$
Storage temperature	Tstg		-40 to +150	$^\circ\text{C}$

* When mounted on the specified printed circuit board : 40mm×50mm×1.6mm, glass epoxy

Recommended Operation Conditions at $T_a = 25^\circ\text{C}$

Parameter	Symbol	Conditions	Ratings			Unit
			min	typ	max	
Supply voltage range	VD	Externally applied voltage	2.7	5	5.5	V
Load impedance range	R _L	Speaker load	4			Ω

Electrical Characteristics at $T_a = 25^\circ\text{C}$, VD = 5V, R_L = 4 Ω , L = 22 μH , C = 0.33 μF

Parameter	Symbol	Conditions	Ratings			Unit
			min	typ	max	
Operating current						
Standby current	I _{st}	$\overline{\text{STBY}} = \text{L}$, $\overline{\text{MUTE}} = \text{L}$, LC less, R _L = OPEN		1	8	μA
Mute current	I _{mute}	$\overline{\text{STBY}} = \text{H}$, $\overline{\text{MUTE}} = \text{L}$, LC less, R _L = OPEN		4.5	7.5	mA
Quiescent current	I _{CCO}	$\overline{\text{STBY}} = \text{H}$, $\overline{\text{MUTE}} = \text{H}$, LC less, R _L = OPEN		6	10	mA
Main amplifier						
Voltage gain	VG	fin = 1kHz, V _O = 0dBm	21.5	23.5	25.5	dB
Total harmonic distortion	THD+N	P _O = 1W, fin = 1kHz, AES17		0.4	0.7	%
Output power	P _O	THD+N = 10%, fin = 1kHz, AES17	1.6	2		W
Ripple rejection ratio	SVRR	fr = 100Hz, Vr = -15dBm, Rg = 0, DIN AUDIO	50	60		dB
Noise	V _{NO}	Rg = 0, DIN AUDIO		70	210	μVrms
Digital input						
High-level output voltage	V _{IH}	STBY pin, MUTE pin	3			V
Low-level output voltage	V _{IL}	STBY pin, MUTE pin			0.3	V
Protection circuit						
Power supply voltage drop protection circuit upper limit value	UV_UPPER	VD pin voltage monitor		2.3		V
Power supply voltage drop protection circuit lower limit value	UV_LOWER	VD pin voltage monitor		2.2		V

Note : The values of these characteristics were measured in the SANYO test environment. The actual values in an end system will vary depending on the printed circuit board pattern, the external components actually used, and other factors.

Package Dimensions

unit : mm (typ)

3322A

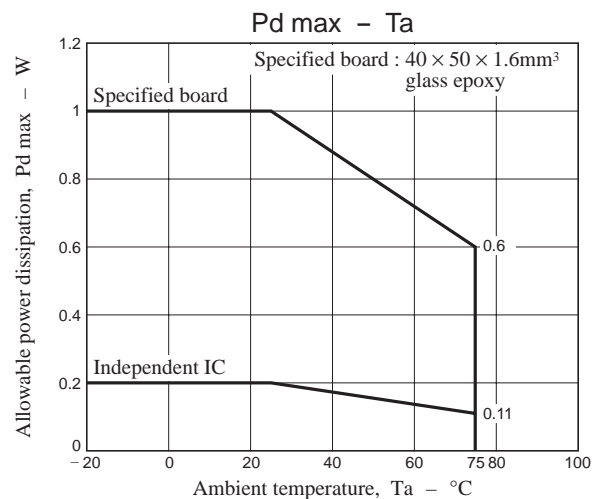
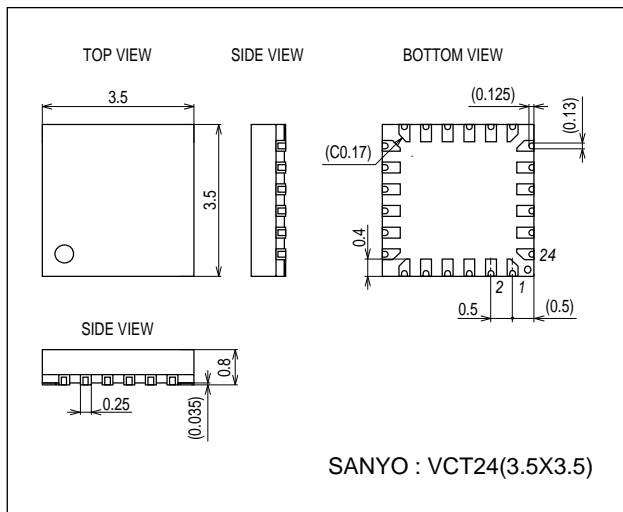

LV4912GP

LV4912GP customer bread board rev.1.0

Size : 40mm × 50mm × 1.6mm

Pattern

Top Layer

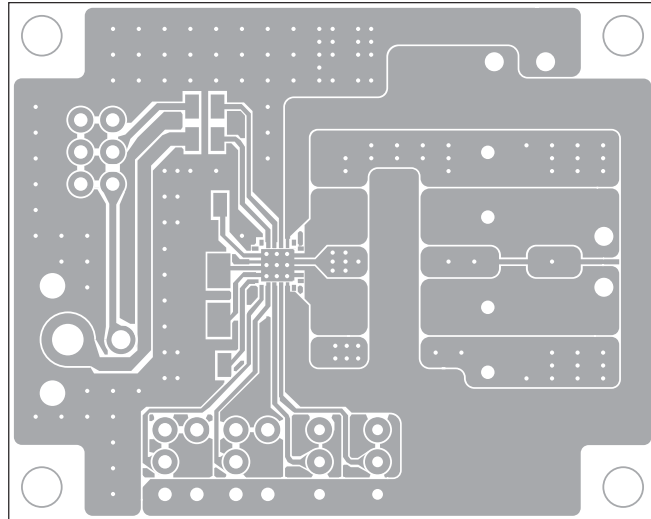

Bottom Layer

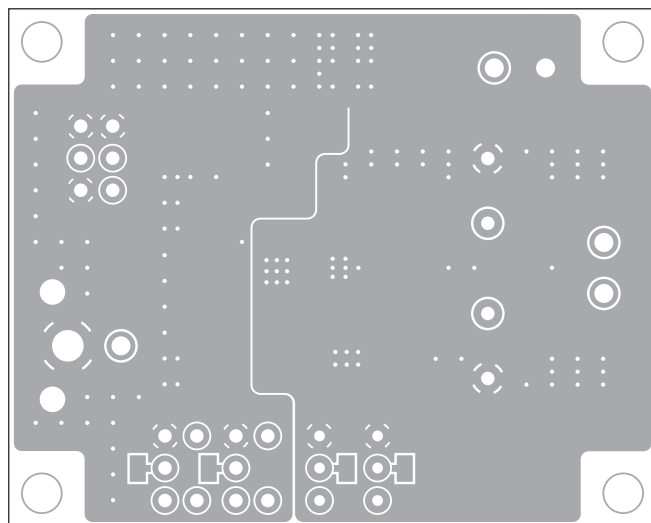

LV4912GP

Block Diagram and Application Circuit Example ($R_L = 4\Omega$)

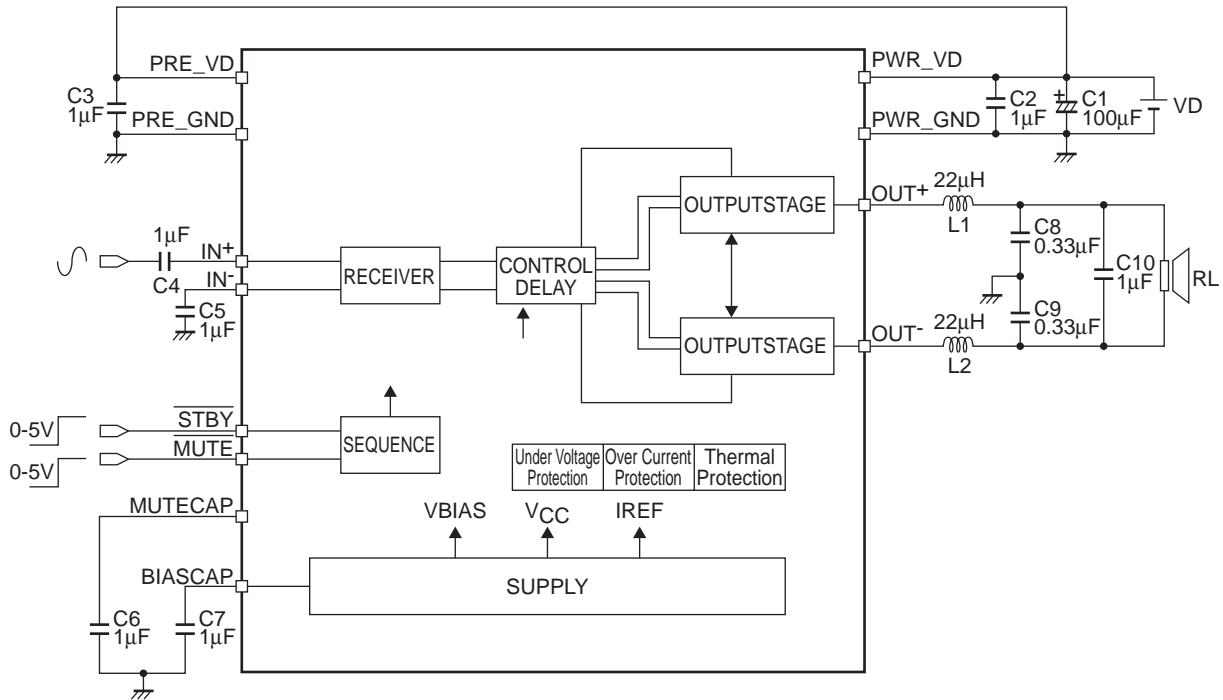

LV4912GP Application ($R_L = 4\Omega$)

Part List

Parts Name	Part No.	Description Function
C_{VD}	C1	Power supply capacitor for VD
C_{VD}	C2, C3	High-frequency cut capacitor for VD
C_{IN}	C4, C5	Input capacitor
C_{MUTE}	C6	Capacitor for soft mute
$C_{BIASCAP}$	C7	Input coupling capacitor for Internal power supply (VBIAS)
L_O	L1, L2	Output L. P. F. coil
C_O	C8, C9, C10	Output L. P. F. capacitor

Pin Assignments

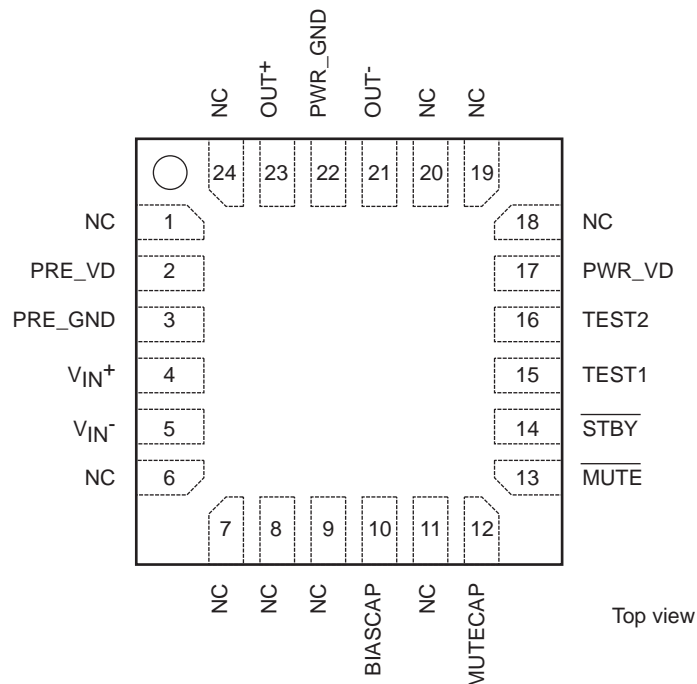

LV4912GP

Pin Equivalent Circuit

Pin No.	Pin Name	I/O	Description	Equivalent Circuit
1	NC		No connection	
2	PRE_VD		Power supply pin	
3	PRE_GND		Pre ground	
4	V _{IN} ⁺	I	Input plus	
5	V _{IN} ⁻	I	Input minus	
6	NC		No connection	
7	NC		No connection	
8	NC		No connection	
9	NC		No connection	
10	BIASCAP	O	Internal power supply decoupling capacitor connection	
11	NC		No connection	
12	MUTECAP	O	Mute capacitor connection	
13	MUTE	I	Mute control pin	

Continued on next page.

LV4912GP

Continued from preceding page.

Pin No.	Pin Name	I/O	Description	Equivalent Circuit
14	$\overline{\text{STBY}}$	I	Standby control pin	
15	TEST1		Test pin	
16	TEST2		Test pin	
17	PWR_VD		Power supply pin	
18	NC		No connection	
19	NC		No connection	
20	NC		No connection	
21	OUT-	O	Output pin, minus	
22	PWR_GND		Power ground	
23	OUT+	O	Output pin, plus	
24	NC		No connection	

Description functions

1. System Standby

Each bias can be turned on/off by switching the STBY pin (pin 14) into high or low. The bias is turned off when the STBY pin is low. Conversely, the bias is turned on when the STBY pin is high.

STBY pin (pin 14)	Bias condition
High	ON
Low	OFF

2. Mute Function

The mute of the output and reduction of power-on popping noise are mainly performed by the use of this function. By switching between high and low on the MUTE pin (pin 13), the output can be muted. The MUTE pin enters the mute mode (PWM output stops) when the MUTE pin is low. Also the MUTE pin enters the operation mode (normal operations) when the MUTE pin is high.

MUTE pin (pin 13)	Conditions
High	Operation mode
Low	Mute mode

We recommend the following sequence for reduction of the popping noise when power is on/off. Also, we recommend the following ON Time and OFF Time when P.4 the application circuit is used.

(1) Power On sequence

The ON Time should secure more than 150msec for reduction of the popping noise.

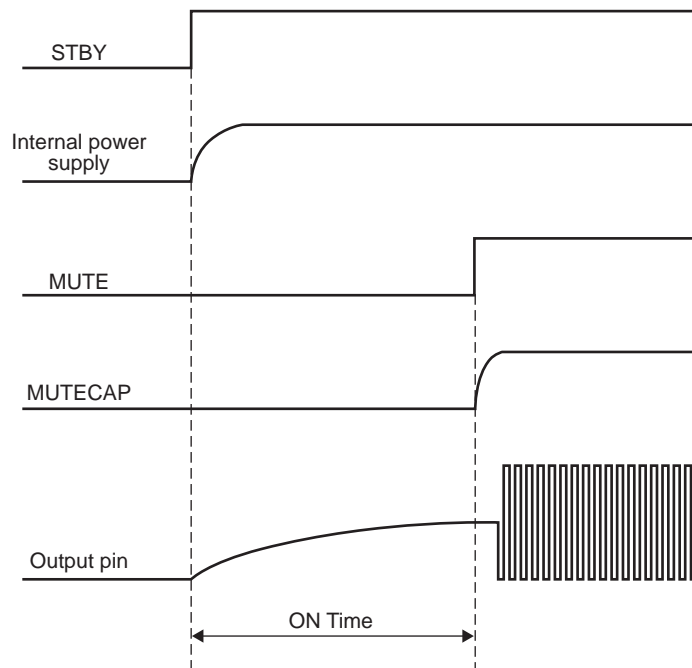

(2) Power Down sequence

The OFF Time should secure more than 100msec for reduction of the popping noise.

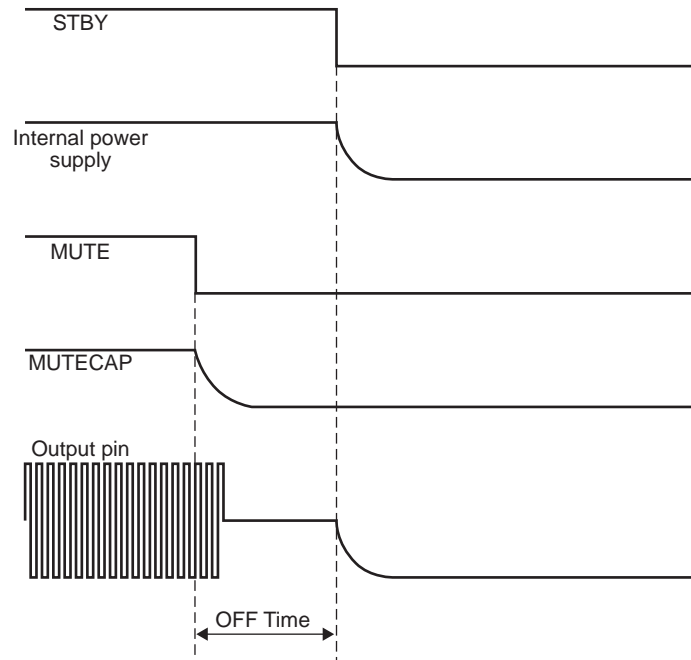

Capacitors for Power supply and pin arrangement

1. Capacitors for power supply

The capacitors C2 and C3 for power supply connected between IC pins must be inserted using the shortest lines possible.

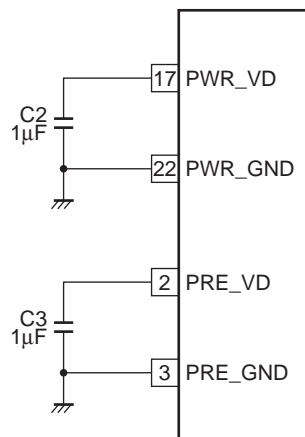

2. Pin arrangement of the test pins (pins 15 and 16)

The test pins (pins 15 and 16) are used as pins for testing before shipment. These pins are not used normally. Therefore, these pins must be left open if the pin arrangement is not performed. Please make sure to connect these pins to GNDs if the pin arrangement is performed.

General Characteristics

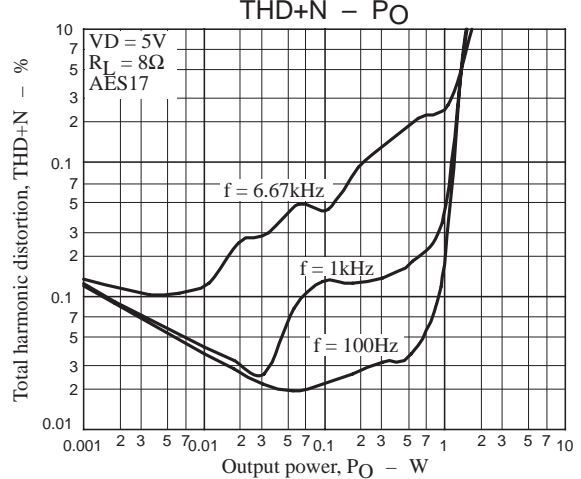
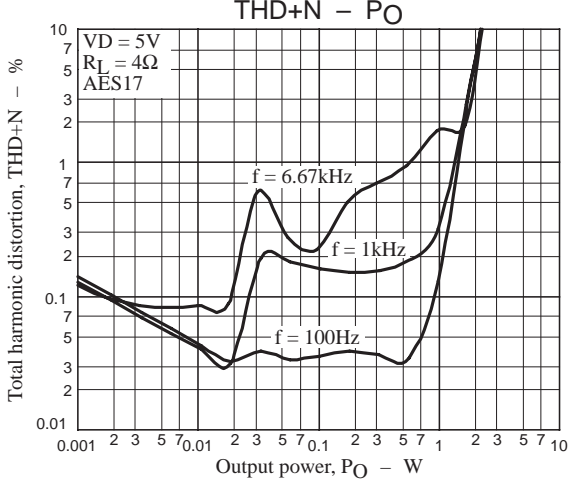
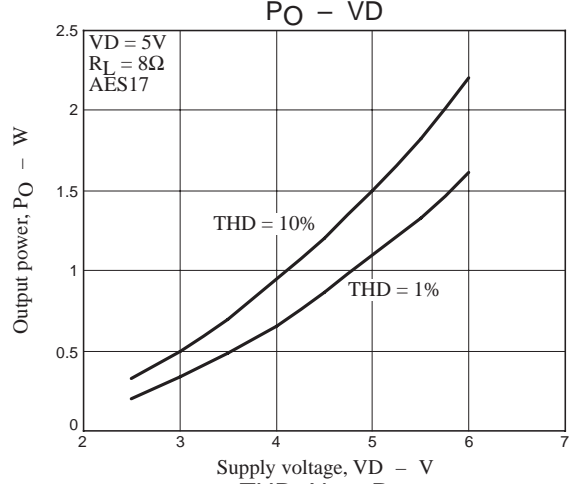
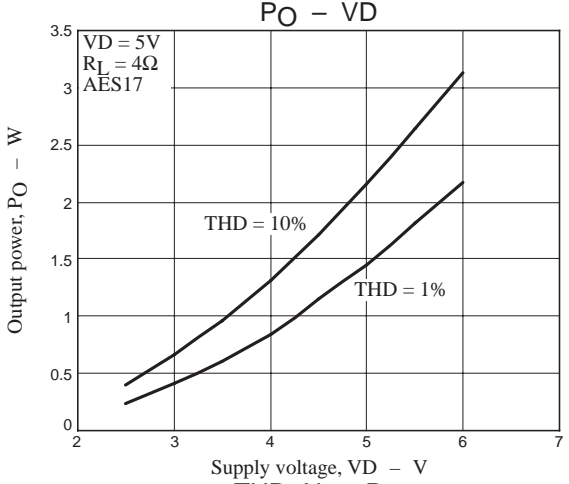
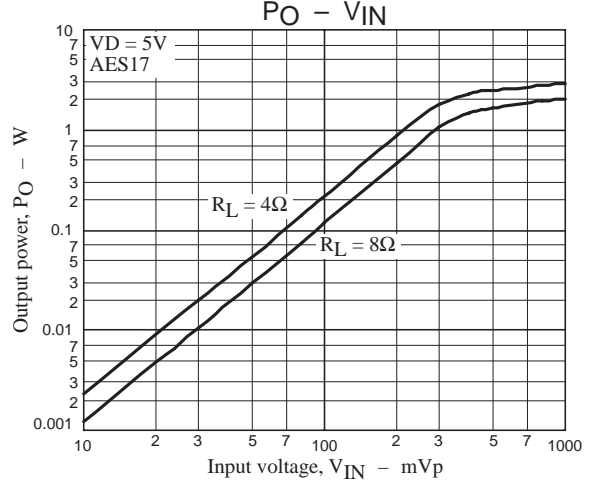
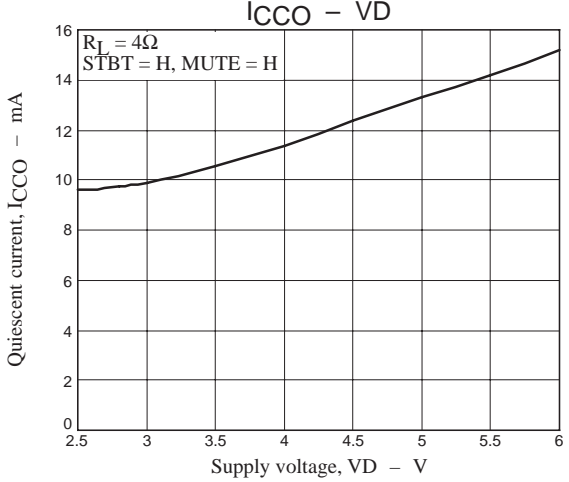
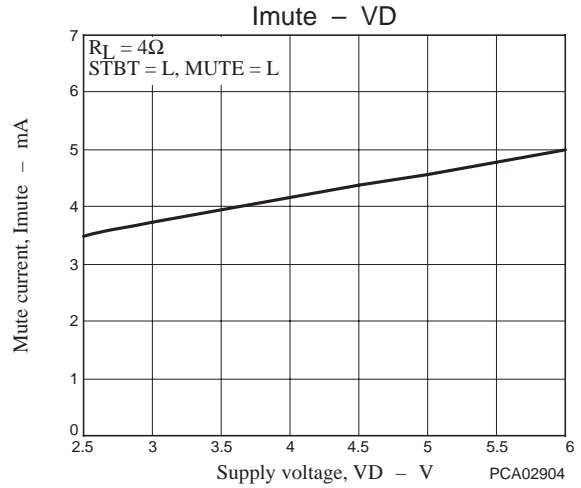
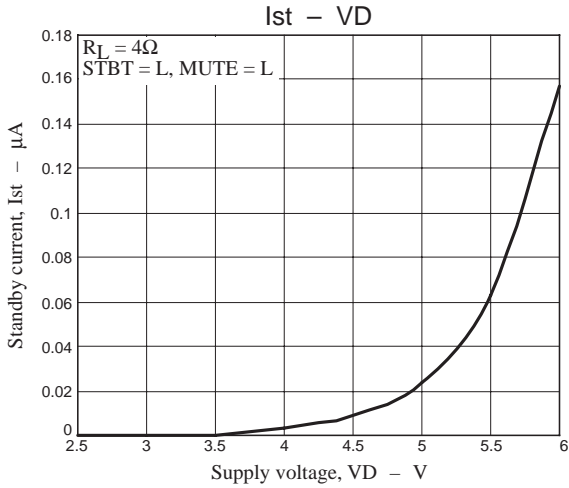

LV4912GP

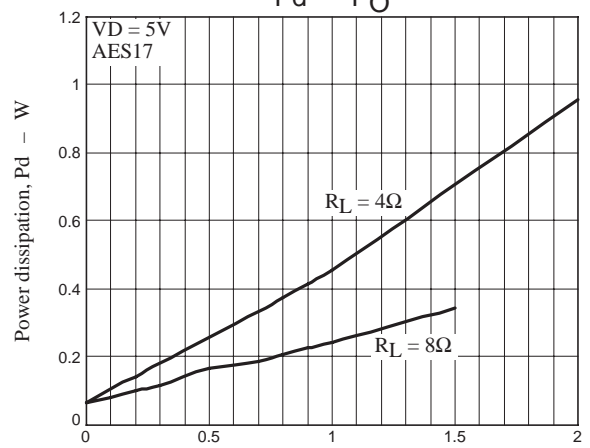
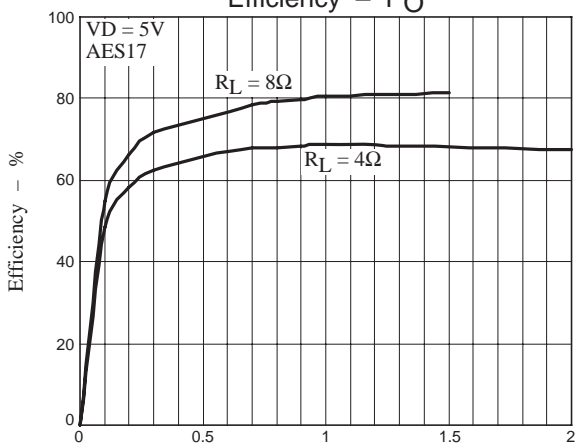
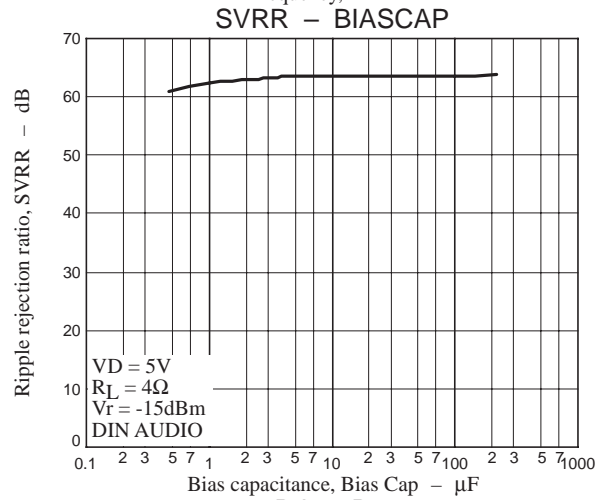
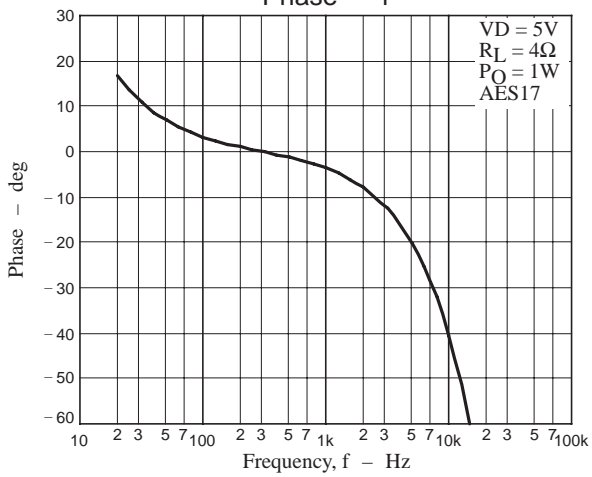
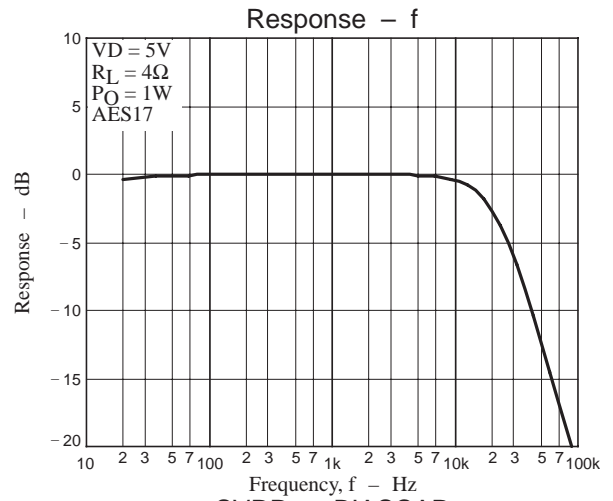
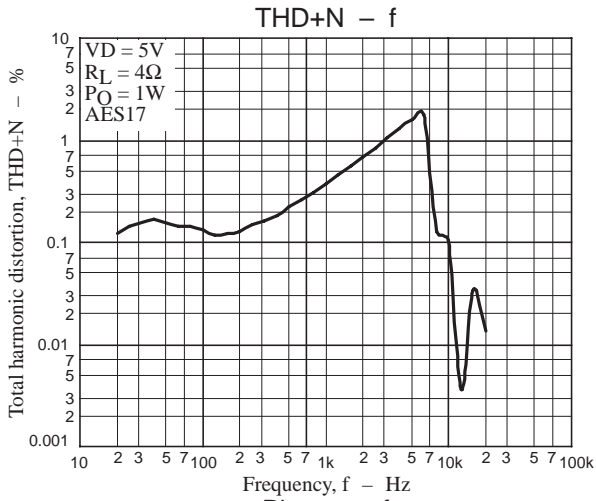

Temperature Characteristics

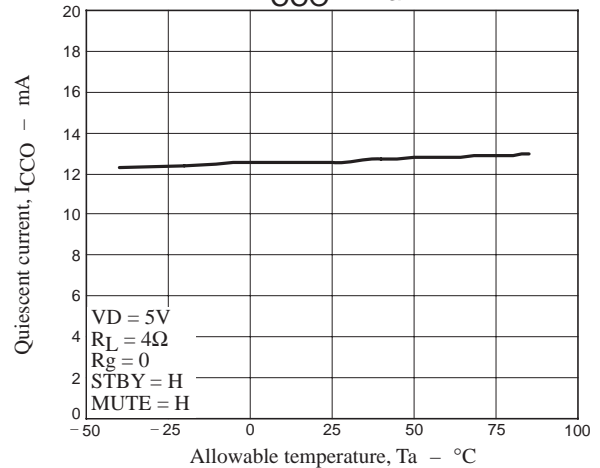
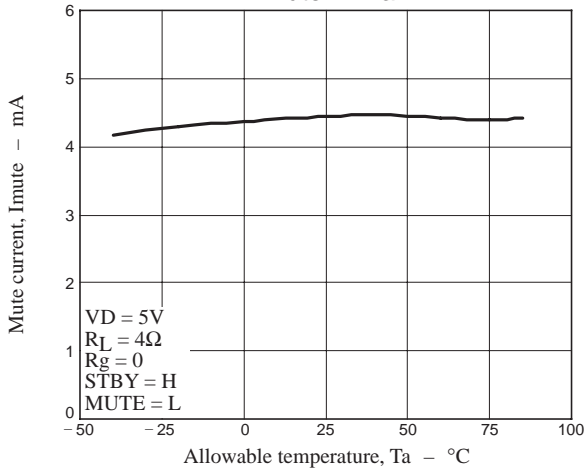

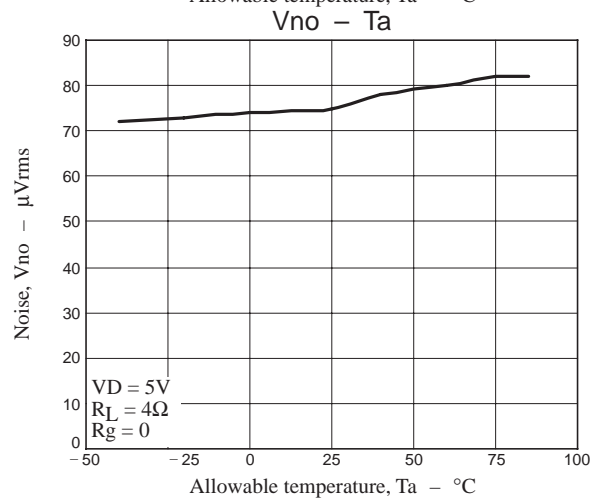
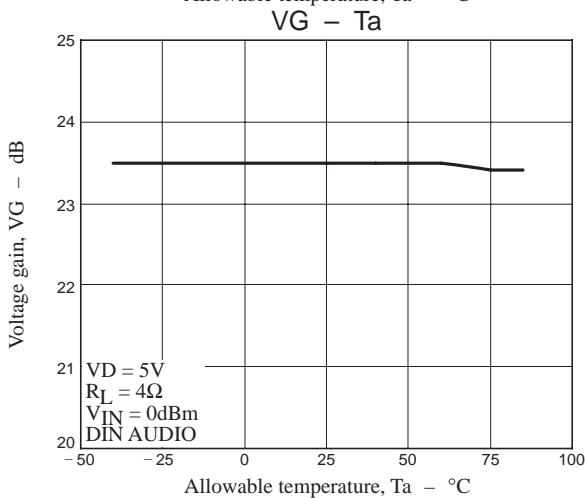
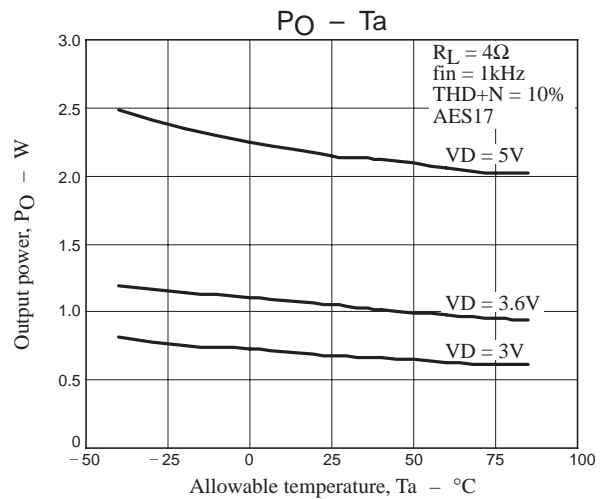
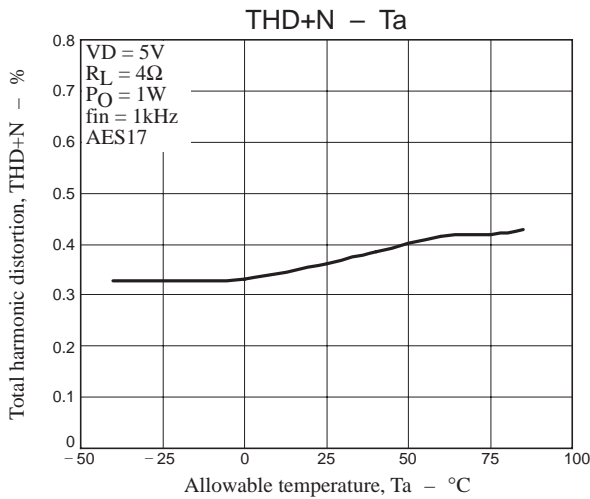

- SANYO Semiconductor Co.,Ltd. assumes no responsibility for equipment failures that result from using products at values that exceed, even momentarily, rated values (such as maximum ratings, operating condition ranges, or other parameters) listed in products specifications of any and all SANYO Semiconductor Co.,Ltd. products described or contained herein.
- SANYO Semiconductor Co.,Ltd. strives to supply high-quality high-reliability products, however, any and all semiconductor products fail or malfunction with some probability. It is possible that these probabilistic failures or malfunction could give rise to accidents or events that could endanger human lives, trouble that could give rise to smoke or fire, or accidents that could cause damage to other property. When designing equipment, adopt safety measures so that these kinds of accidents or events cannot occur. Such measures include but are not limited to protective circuits and error prevention circuits for safe design, redundant design, and structural design.
- In the event that any or all SANYO Semiconductor Co.,Ltd. products described or contained herein are controlled under any of applicable local export control laws and regulations, such products may require the export license from the authorities concerned in accordance with the above law.
- No part of this publication may be reproduced or transmitted in any form or by any means, electronic or mechanical, including photocopying and recording, or any information storage or retrieval system, or otherwise, without the prior written consent of SANYO Semiconductor Co.,Ltd.
- Any and all information described or contained herein are subject to change without notice due to product/technology improvement, etc. When designing equipment, refer to the "Delivery Specification" for the SANYO Semiconductor Co.,Ltd. product that you intend to use.
- Information (including circuit diagrams and circuit parameters) herein is for example only; it is not guaranteed for volume production.
- Upon using the technical information or products described herein, neither warranty nor license shall be granted with regard to intellectual property rights or any other rights of SANYO Semiconductor Co.,Ltd. or any third party. SANYO Semiconductor Co.,Ltd. shall not be liable for any claim or suits with regard to a third party's intellectual property rights which has resulted from the use of the technical information and products mentioned above.

This catalog provides information as of June, 2011. Specifications and information herein are subject to change without notice.