

MAX5394

Single, 256-Tap Volatile, SPI, Low-Voltage Linear Taper Digital Potentiometer

General Description

The MAX5394 single, 256-tap volatile, low-voltage linear taper digital potentiometer offers three end-to-end resistance values of 10kΩ, 50kΩ, and 100kΩ. Potentiometer terminals are independent of supply for voltages up to 5.25V with single-supply operation from 1.7V to 5.5V (charge pump enabled). User-controlled shutdown modes allow the H, W, or L terminal to be opened with the wiper position set to zero-code, mid-code, full-code, or the value contained in the wiper register. Ultra-low-quiescent supply current (< 1μA) can be achieved for supply voltages between 2.6V and 5.5V by disabling the internal charge pump and not allowing potentiometer terminals to exceed the supply voltage by more than 0.3V. The MAX5394 provides a low 50ppm/°C end-to-end temperature coefficient and features a SPI serial interface.

The small package size, low operating supply voltage, low supply current, and automotive temperature range of the MAX5394 make the device uniquely suited for the portable consumer market, battery-backup industrial applications, and automotive market.

The MAX5394 is available in a lead-free, 8-pin TDFN package. The device operates over the -40°C to +125°C automotive temperature range.

Ordering Information appears at end of data sheet.

Features

- ◆ Single Linear Taper 256-Tap Positions
- ◆ 10kΩ, 50kΩ, and 100kΩ End-to-End Resistance
- ◆ 1.7V to 5.5V Extended Single Supply
- ◆ 0 to 5.25V H, W, L Operating Voltage Independent of V_{DD}
- ◆ 1μA (typ) Supply Current in Low-Power Mode
- ◆ ±1.0 LSB INL, ±0.5 LSB DNL (max) Wiper Accuracy
- ◆ Power-On Sets Wiper to Midscale
- ◆ 50ppm/°C End-to-End Temperature Coefficient
- ◆ 5ppm/°C Ratiometric Temperature Coefficient
- ◆ -40°C to +125°C Operating Temperature Range
- ◆ 2mm x 2mm, 8-Pin TDFN Package
- ◆ SPI-Compatible Serial Interface

Applications

Portable Electronics
 System Calibration
 Battery-Powered Systems
 Automotive Electronics
 Mechanical Potentiometer Replacement

Typical Operating Circuit

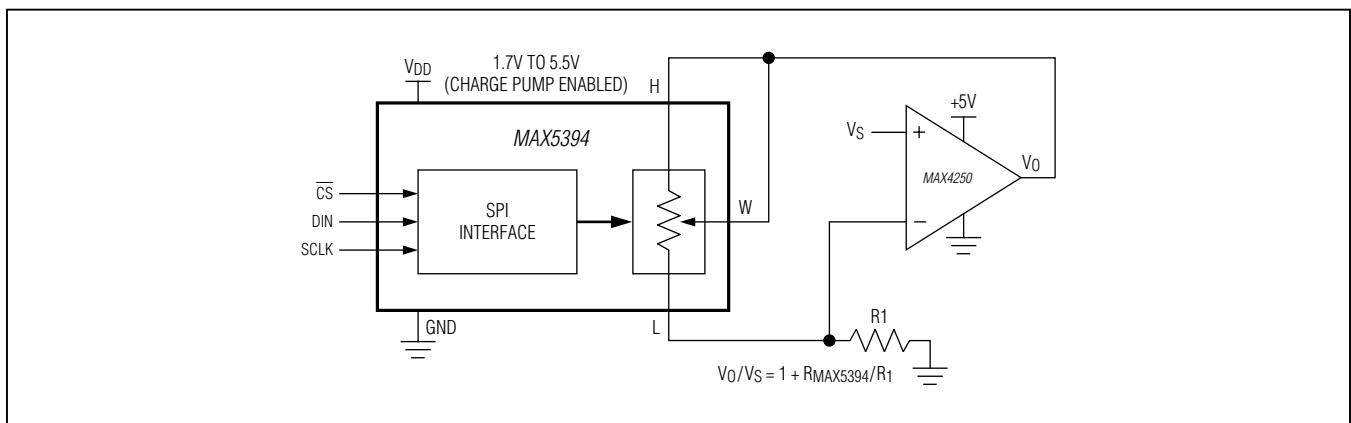

For related parts and recommended products to use with this part, refer to: www.maximintegrated.com/MAX5394.related

For pricing, delivery, and ordering information, please contact Maxim Direct at 1-888-629-4642, or visit Maxim's website at www.maximintegrated.com.

MAX5394

Single, 256-Tap Volatile, SPI, Low-Voltage Linear Taper Digital Potentiometer

ABSOLUTE MAXIMUM RATINGS

(All voltages referenced to GND.)

V_{DD}	-0.3V to +6V
H, W, L (charge pump enabled)	-0.3V to +5.5V
H, W, L (charge pump disabled)	-0.3V to the lower of ($V_{DD} + 0.3V$) or +6V
All Other Pins	-0.3V to +6V
Continuous Current into H, W, and L	
MAX5394L	5mA
MAX5394M	2mA
MAX5394N	1mA

Maximum Current into Any Input	50mA
Continuous Power Dissipation ($T_A = +70^\circ\text{C}$)	
TDFN (derate 11.9mW/ $^\circ\text{C}$ above +70 $^\circ\text{C}$)	953.5mW
Operating Temperature Range	-40 $^\circ\text{C}$ to +125 $^\circ\text{C}$
Storage Temperature Range	-65 $^\circ\text{C}$ to +150 $^\circ\text{C}$
Junction Temperature	+150 $^\circ\text{C}$
Lead Temperature (soldering, 10s)	+300 $^\circ\text{C}$
Soldering Temperature (reflow)	+260 $^\circ\text{C}$

Stresses beyond those listed under "Absolute Maximum Ratings" may cause permanent damage to the device. These are stress ratings only, and functional operation of the device at these or any other conditions beyond those indicated in the operational sections of the specifications is not implied. Exposure to absolute maximum rating conditions for extended periods may affect device reliability.

PACKAGE THERMAL CHARACTERISTICS (Note 1)

TDFN

Junction-to-Ambient Thermal Resistance (θ_{JA})	83.9 $^\circ\text{C}/\text{W}$
Junction-to-Case Thermal Resistance (θ_{JC})	37.0 $^\circ\text{C}/\text{W}$

Note 1: Package thermal resistances were obtained using the method described in JEDEC specification JESD51-7, using a four-layer board. For detailed information on package thermal considerations, refer to www.maximintegrated.com/thermal-tutorial.

ELECTRICAL CHARACTERISTICS

($V_{DD} = 1.7V$ to 5.5V, $V_H = V_{DD}$, $V_L = \text{GND}$, $T_A = -40^\circ\text{C}$ to +125 $^\circ\text{C}$, unless otherwise noted. Typical values are at $V_{DD} = 1.8V$, $T_A = +25^\circ\text{C}$.) (Note 2)

PARAMETER	SYMBOL	CONDITIONS	MIN	TYP	MAX	UNITS
RESOLUTION						
256-Tap Family	N		256			Tap
DC PERFORMANCE (VOLTAGE-DIVIDER MODE)						
Integral Nonlinearity (Note 3)	INL		-1.0		+1.0	LSB
Differential Nonlinearity	DNL	(Note 3)	-0.5		+0.5	LSB
Ratiometric Resistor Tempco		$(DV_W/V_W)/DT$, $V_H = V_{DD}$, $V_L = \text{GND}$, no load		5		ppm/ $^\circ\text{C}$
Full-Scale Error (Code FFh)		Charge pump enabled, 1.7V < V_{DD} < 5.5V	-0.5			LSB
		Charge pump disabled, 2.6V < V_{DD} < 5.5V	MAX5394M MAX5394N	-0.5		
			MAX5394L	-1.0		
Zero-Scale Error (Code 00h)		Charge pump enabled, 1.7V < V_{DD} < 5.5V			+0.5	LSB
		Charge pump disabled, 2.6V < V_{DD} < 5.5V	MAX5394M MAX5394N		+0.5	
			MAX5394L		+1.0	
DC PERFORMANCE (VARIABLE RESISTOR MODE)						
Integral Nonlinearity (Note 4)	R-INL	Charge pump enabled, 1.7V < V_{DD} < 5.5V	-1.0		+1.0	LSB
		Charge pump disabled, 2.6V < V_{DD} < 5.5V	MAX5394M MAX5394N	-1.0	+1.0	
			MAX5394L	-1.5	+1.5	

MAX5394

Single, 256-Tap Volatile, SPI, Low-Voltage Linear Taper Digital Potentiometer

ELECTRICAL CHARACTERISTICS (continued)

($V_{DD} = 1.7V$ to $5.5V$, $V_H = V_{DD}$, $V_L = GND$, $T_A = -40^{\circ}C$ to $+125^{\circ}C$, unless otherwise noted. Typical values are at $V_{DD} = 1.8V$, $T_A = +25^{\circ}C$.) (Note 2)

PARAMETER	SYMBOL	CONDITIONS	MIN	TYP	MAX	UNITS	
Differential Nonlinearity	R-DNL	(Note 4)	-0.5		+0.5	LSB	
Wiper Resistance (Note 5)	R_{WL}	Charge pump enabled, $1.7V < V_{DD} < 5.5V$		25	50	Ω	
		Charge pump disabled, $2.6V < V_{DD} < 5.5V$			200		
DC PERFORMANCE (RESISTOR CHARACTERISTICS)							
Terminal Capacitance	C_H, C_L	Measured to GND		10		pF	
Wiper Capacitance	C_W	Measured to GND		20		pF	
End-to-End Resistor Tempco	T_{CR}	No load		50		ppm/ $^{\circ}C$	
End-to-End Resistor Tolerance		Wiper not connected	-25		+25	%	
AC PERFORMANCE							
-3dB Bandwidth	BW	Code = 80h, 10pF load, $V_{DD} = 1.8V$	10k Ω	1600		kHz	
			50k Ω	340			
			100k Ω	165			
Total Harmonic Distortion Plus Noise	THD+N	(Note 6)		0.035		%	
Wiper Settling Time	t_S	(Note 7)	10k Ω	190		ns	
			50k Ω	400			
			100k Ω	664			
Charge-Pump Feedthrough at W	V_{RW}			600		nV _{RMS}	
POWER SUPPLIES							
Supply Voltage Range	V_{DD}		1.7		5.5	V	
Terminal Voltage Range (H, W, L to GND)		Charge pump enabled, $1.7V < V_{DD} < 5.5V$	0		5.25	V	
		Charge pump disabled, $2.6V < V_{DD} < 5.5V$	0		V_{DD}		
Supply Current (Note 8)	I_{VDD}	Charge pump disabled, $2.6V < V_{DD} < 5.5V$		1		μA	
		Charge pump enabled, $1.7V < V_{DD} < 5.5V$	$V_{DD} = 5.5V$		25		
			$V_{DD} = 1.7V$		20		
DIGITAL INPUTS							
Minimum Input High Voltage	V_{IH}	$2.6V < V_{DD} < 5.5V$	70			% $\times V_{DD}$	
		$1.7V < V_{DD} < 2.6V$	80				
Maximum Input Low Voltage	V_{IL}	$2.6V < V_{DD} < 5.5V$			30	% $\times V_{DD}$	
		$1.7V < V_{DD} < 2.6V$			20		
Input Leakage Current			-1		+1	μA	
Input Capacitance				5		pF	

MAX5394

Single, 256-Tap Volatile, SPI, Low-Voltage Linear Taper Digital Potentiometer

ELECTRICAL CHARACTERISTICS (continued)

($V_{DD} = 1.7V$ to $5.5V$, $V_H = V_{DD}$, $V_L = GND$, $T_A = -40^{\circ}C$ to $+125^{\circ}C$, unless otherwise noted. Typical values are at $V_{DD} = 1.8V$, $T_A = +25^{\circ}C$.) (Note 2)

PARAMETER	SYMBOL	CONDITIONS		MIN	TYP	MAX	UNITS
TIMING CHARACTERISTICS (Note 9)							
SCLK Frequency	f_{SCLK}	$2.6V < V_{DD} < 5.5V$				50	MHz
		$1.7V < V_{DD} < 2.6V$				25	
SCLK Period	t_{SCLK}	$2.6V < V_{DD} < 5.5V$		20			ns
		$1.7V < V_{DD} < 2.6V$		40			
SCLK Pulse-Width High	t_{CH}			8			ns
SCLK Pulse-Width Low	t_{CL}			8			ns
\overline{CS} Fall to SCLK Fall Setup Time	t_{CSS0}	To 1st SCLK falling edge (FE)	$2.6V < V_{DD} < 5.5V$	8			ns
			$1.7V < V_{DD} < 2.6V$	16			
\overline{CS} Fall to SCLK Fall Hold Time	t_{CSH0}	Applies to inactive FE preceding 1st FE		0			ns
\overline{CS} Rise to SCLK Fall Hold Time	t_{CSH1}	Applies to 16th FE		0			ns
\overline{CS} Rise to SCLK Fall	t_{CSA}	Applies to 16th FE, aborted sequence	$2.6V < V_{DD} < 5.5V$	12			ns
			$1.7V < V_{DD} < 2.6V$	16			
SCLK Fall to \overline{CS} Fall	t_{CSF}	Applies to 16th FE		100			ns
\overline{CS} Pulse-Width High	t_{CSPW}			20			ns
DIN to SCLK Fall Setup Time	t_{DS}			5			ns
DIN to SCLK Fall Hold Time	t_{DH}			4.5			ns
\overline{CS} Pulse-Width High	t_{CSPW}			20			ns

Note 2: All devices are production tested at $T_A = +25^{\circ}C$ and are guaranteed by design and characterization for $T_A = -40^{\circ}C$ to $+125^{\circ}C$.

Note 3: DNL and INL are measured with the potentiometer configured as a voltage-divider with $V_H = 5.25$ (QP enabled) or V_{DD} (QP disabled) and $V_L = GND$. The wiper terminal is unloaded and measured with an ideal voltmeter.

Note 4: R-DNL and R-INL are measured with the potentiometer configured as a variable resistor (Figure 1). H is unconnected and $L = GND$.

For charge pump enabled, $V_{DD} = 1.7V$ to $5.5V$, the wiper terminal is driven with a source current of $400\mu A$ for the $10k\Omega$ configuration, $80\mu A$ for the $50k\Omega$ configuration, and $40\mu A$ for the $100k\Omega$ configuration.

For charge pump disabled and $V_{DD} = 5.5V$, the wiper terminal is driven with a source current of $400\mu A$ for the $10k\Omega$ configuration, $80\mu A$ for the $50k\Omega$ configuration, and $40\mu A$ for the $100k\Omega$ configuration.

For charge pump disabled and $V_{DD} = +2.6V$, the wiper terminal is driven with a source current of $200\mu A$ for the $10k\Omega$ configuration, $40\mu A$ for the $50k\Omega$ configuration, and $20\mu A$ for the $100k\Omega$ configuration.

Note 5: The wiper resistance is the maximum value measured by injecting the currents given in Note 4 into W with $L = GND$. $R_W = (V_W - V_H)/I_W$.

Note 6: Measured at W with H driven with a 1kHz, 0V to V_{DD} amplitude tone and $V_L = GND$. Wiper at midscale with a $10pF$ load.

Note 7: Wiper-settling time is the worst-case 0-to-50% rise time, measured between tap 0 and tap 127. $H = V_{DD}$, $L = GND$, and the wiper terminal is loaded with $10pF$ capacitance to ground.

Note 8: Digital inputs at V_{DD} or GND .

Note 9: Digital timing is guaranteed by design and characterization, and is not production tested.

MAX5394

Single, 256-Tap Volatile, SPI, Low-Voltage Linear Taper Digital Potentiometer

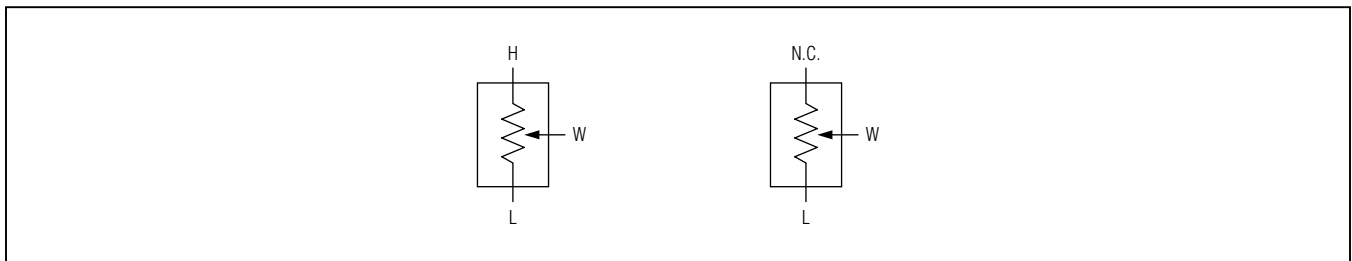

Figure 1. Voltage-Divider and Variable Resistor Configurations

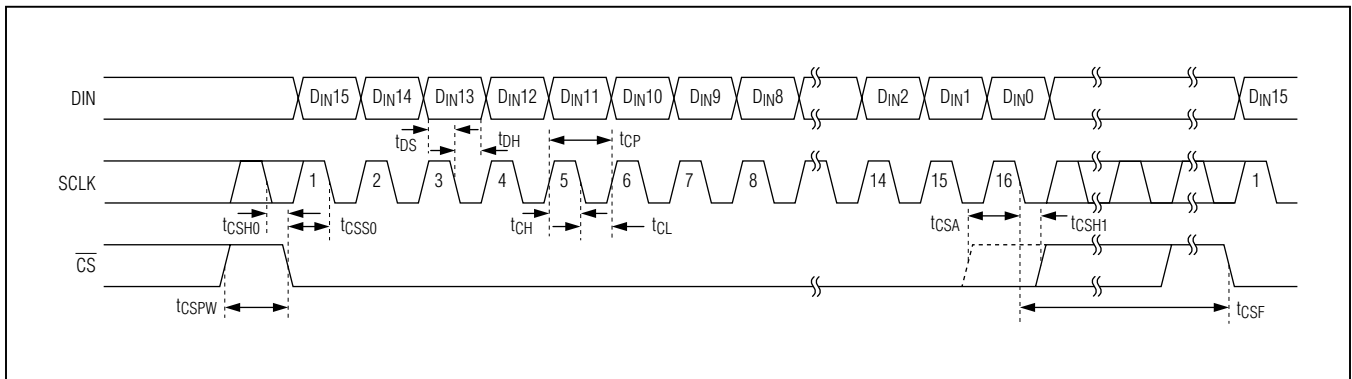

Figure 2. SPI Timing Diagram

MAX5394

Single, 256-Tap Volatile, SPI, Low-Voltage Linear Taper Digital Potentiometer

Typical Operating Characteristics

($V_{DD} = 1.8V$, $T_A = +25^\circ C$, unless otherwise noted.)

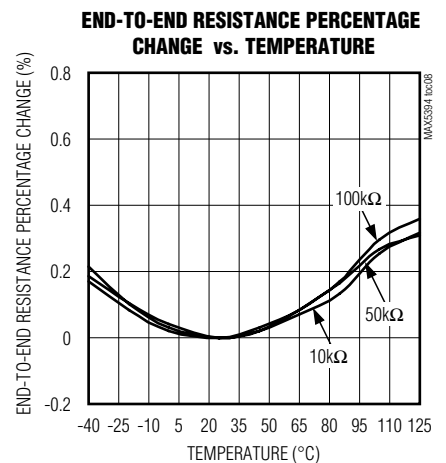
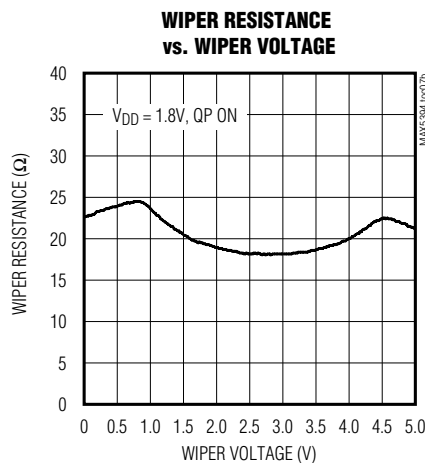
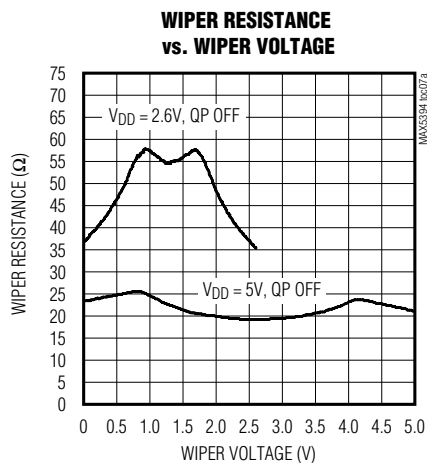
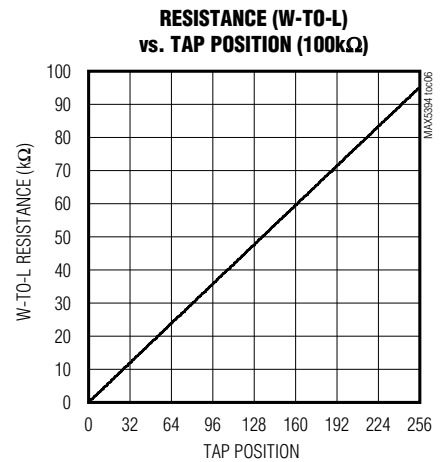
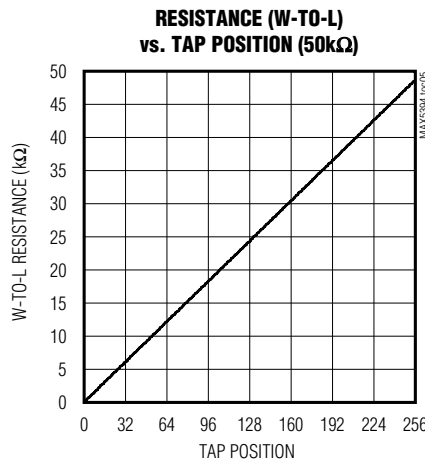
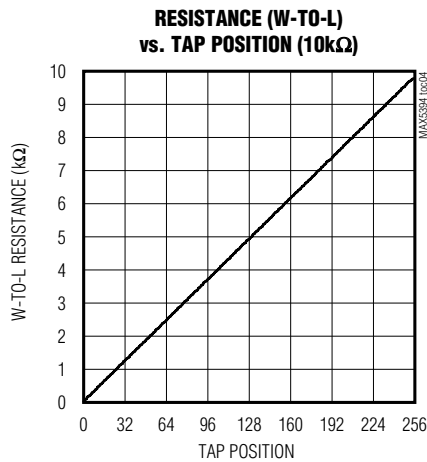
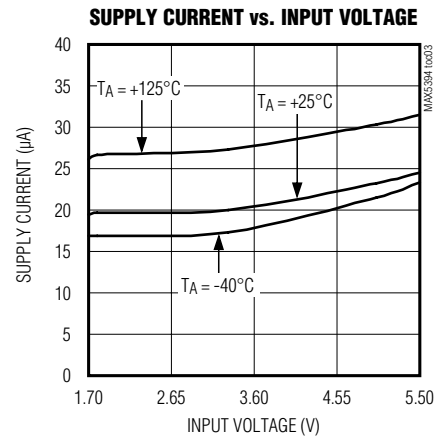
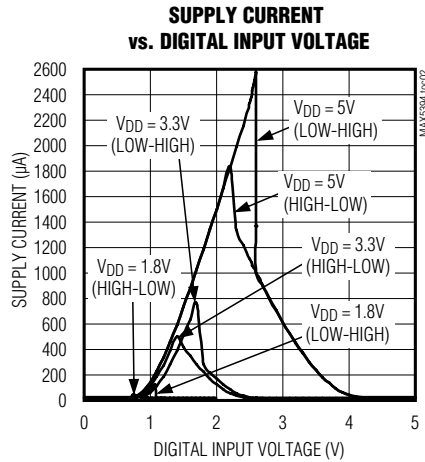
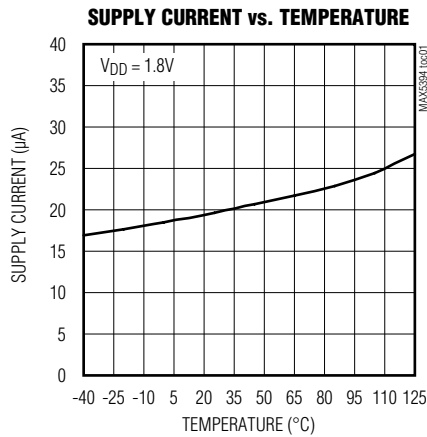

MAX5394

Single, 256-Tap Volatile, SPI, Low-Voltage Linear Taper Digital Potentiometer

Typical Operating Characteristics (continued)

($V_{DD} = 1.8V$, $T_A = +25^\circ C$, unless otherwise noted.)

**TAP-TO-TAP SWITCHING TRANSIENT
(CODE 127 TO 128 10k Ω)**

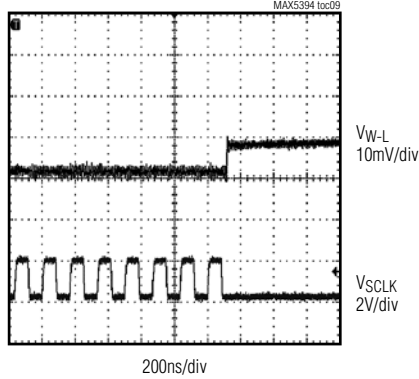

**TAP-TO-TAP SWITCHING TRANSIENT
(CODE 127 TO 128 50k Ω)**

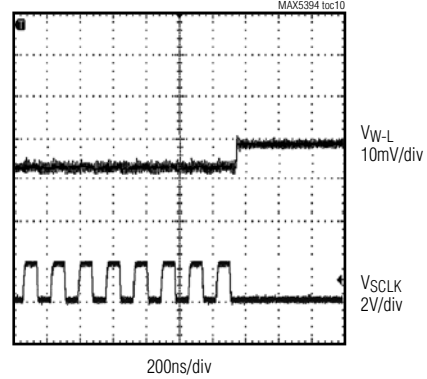

**TAP-TO-TAP SWITCHING TRANSIENT
(CODE 127 TO 128 100k Ω)**

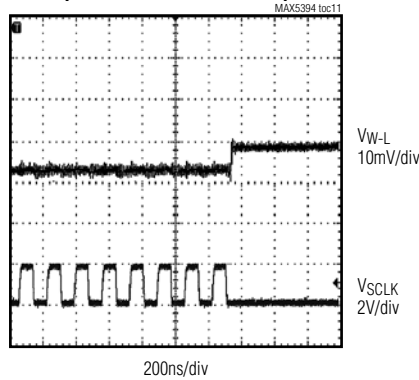

POWER-ON TRANSIENT (10k Ω)

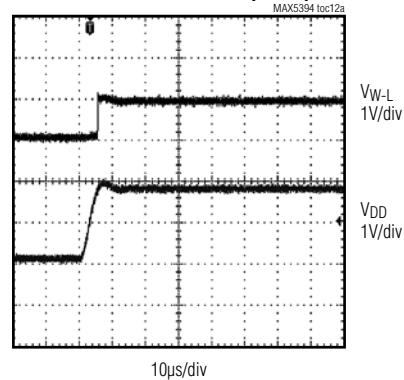

POWER-ON TRANSIENT (50k Ω)

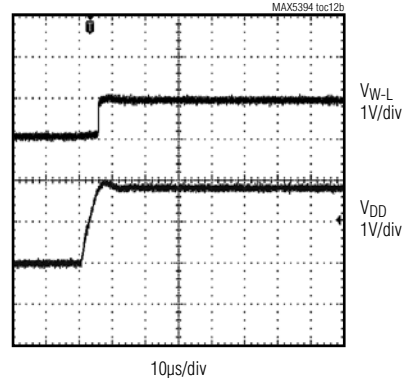

POWER-ON TRANSIENT (100k Ω)

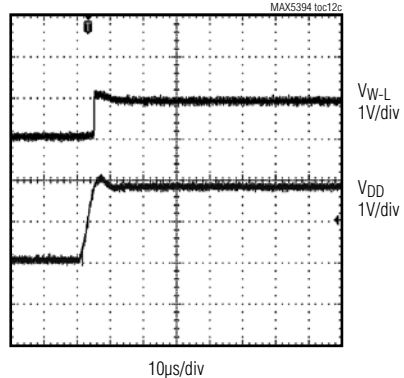

MAX5394

Single, 256-Tap Volatile, SPI, Low-Voltage Linear Taper Digital Potentiometer

Typical Operating Characteristics (continued)

($V_{DD} = 1.8V$, $T_A = +25^\circ C$, unless otherwise noted.)

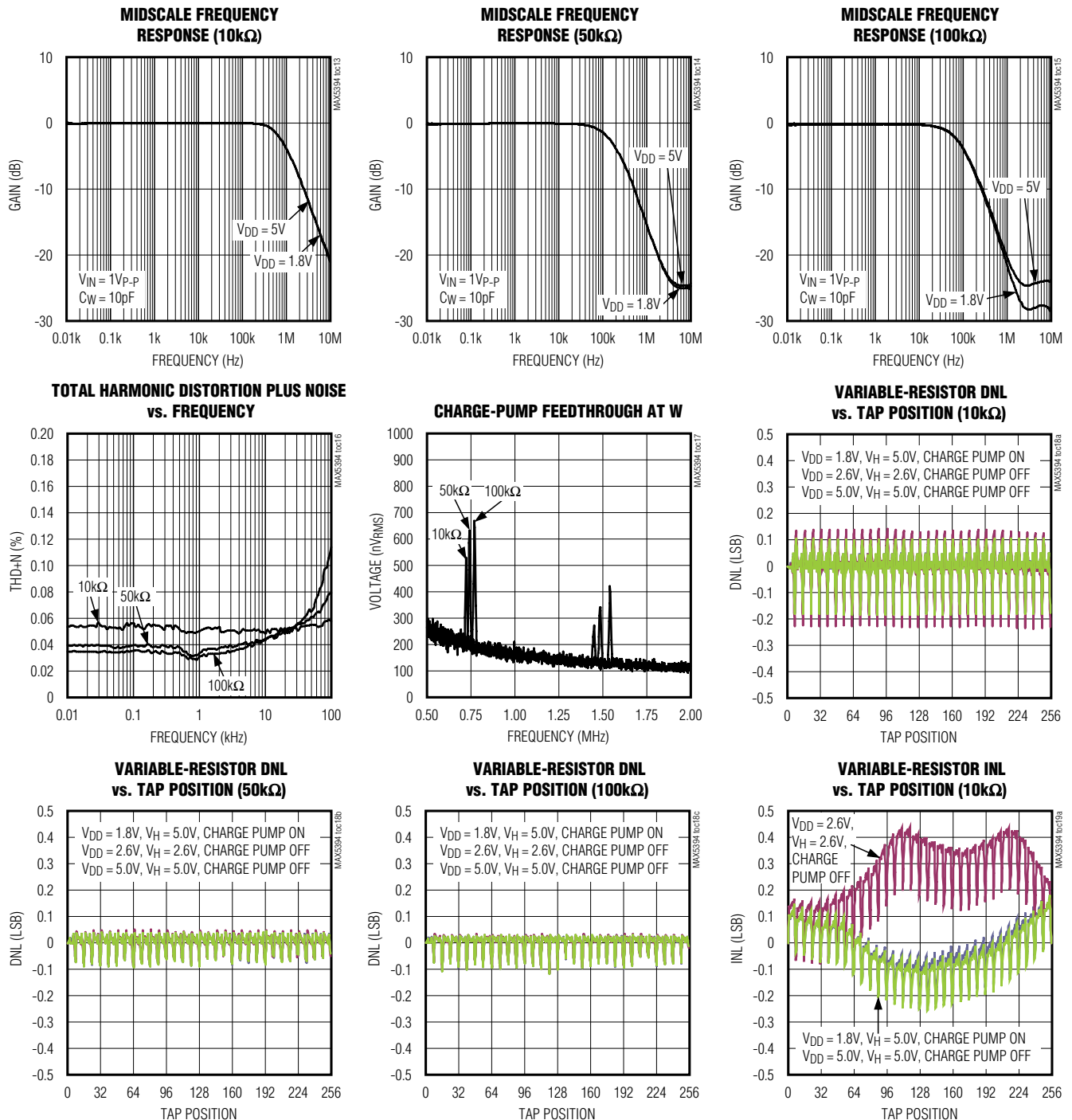

MAX5394

Single, 256-Tap Volatile, SPI, Low-Voltage Linear Taper Digital Potentiometer

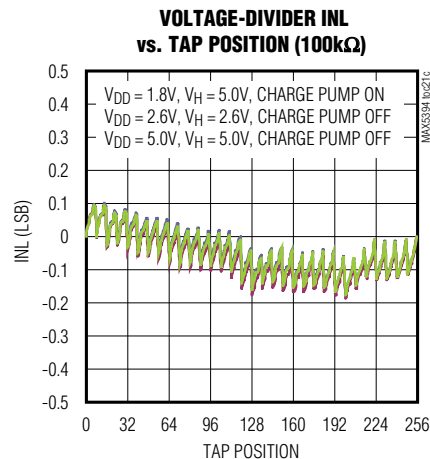
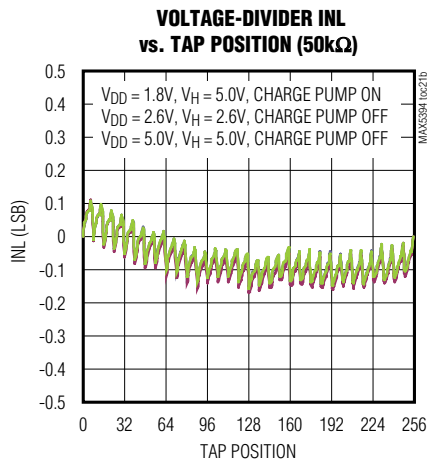
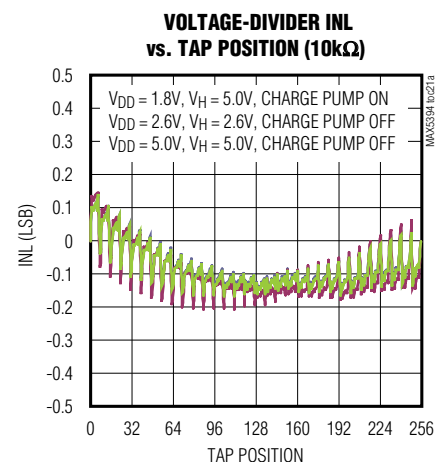
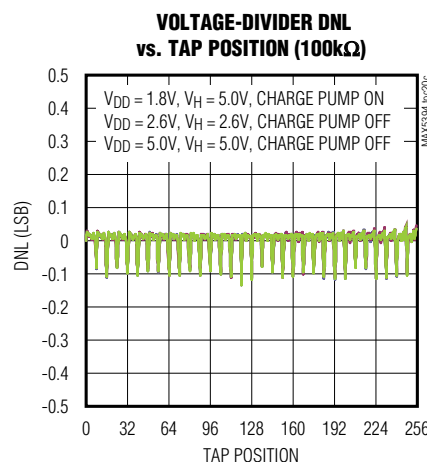
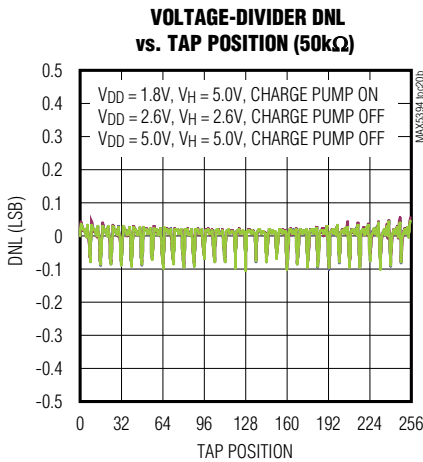
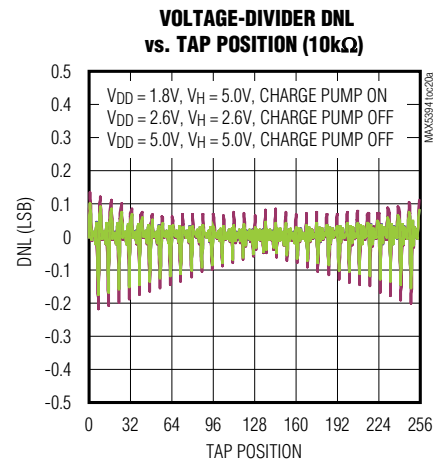
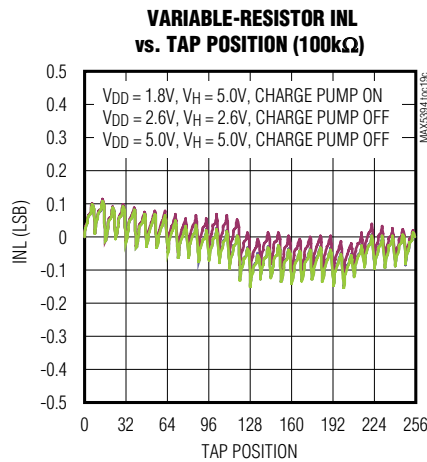
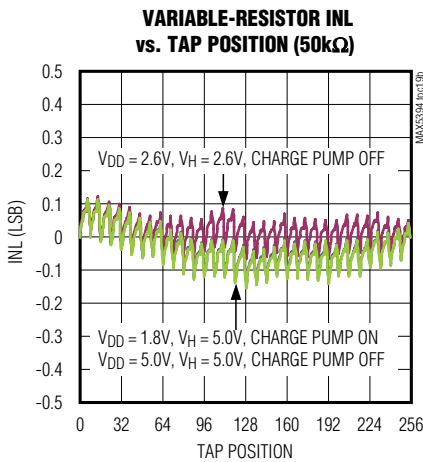

MAX5394

Single, 256-Tap Volatile, SPI, Low-Voltage Linear Taper Digital Potentiometer

Pin Configuration

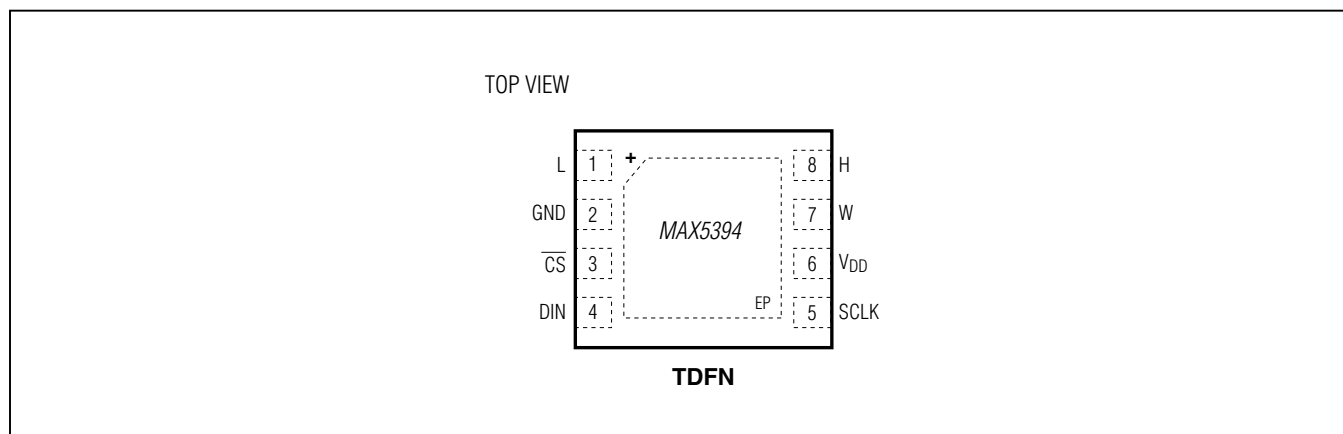

Pin Description

PIN	NAME	FUNCTION
1	L	Low Terminal. The voltage at L can be greater than or less than the voltage at H. Current can flow into or out of L.
2	GND	Ground
3	$\overline{\text{CS}}$	Active-Low Chip-Select Digital Input
4	DIN	Serial-Interface Data Input
5	SCLK	Serial-Interface Clock Input
6	V _{DD}	Power Supply
7	W	Wiper Terminal
8	H	High Terminal. The voltage at H can be greater than or less than the voltage at L. Current can flow into or out of H.
—	EP	Exposed Pad. Internally connected to GND. Connected to ground.

MAX5394

Single, 256-Tap Volatile, SPI, Low-Voltage Linear Taper Digital Potentiometer

Functional Diagram

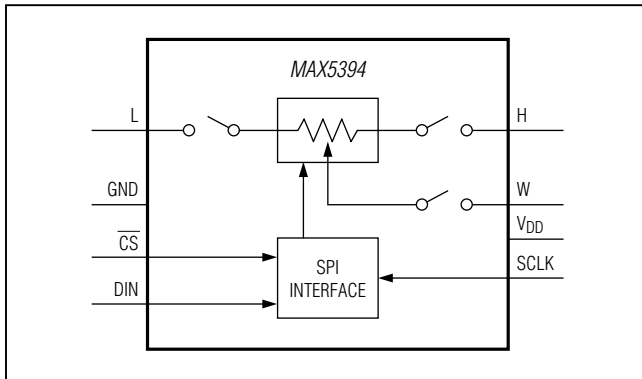

Detailed Description

The MAX5394 single, 256-tap volatile, low-voltage linear taper digital potentiometer offers three end-to-end resistance values of 10k Ω , 50k Ω , and 100k Ω . Potentiometer terminals are independent of supply for voltages up to +5.25V with single-supply operation from 1.7V to 5.5V (charge pump enabled). User-controlled shutdown modes allow the H, W, or L terminals to be opened with the wiper position set to zero-code, midcode, full-code, or the value contained in the wiper register. Ultra-low-quiescent supply current (< 1 μ A) can be achieved for supply voltages between 2.6V and 5.5V by disabling the internal charge pump and not allowing potentiometer terminals to exceed the supply voltage by more than 0.3V. The MAX5394 provides a low 50ppm/ $^{\circ}$ C end-to-end temperature coefficient and features a SPI serial interface.

The small package size, low supply operating voltage, low supply current, and automotive temperature range of the MAX5394 make the device uniquely suited for the

portable consumer market, battery-backup industrial applications, and automotive market.

Charge Pump

The MAX5394 contains an internal charge pump that guarantees the maximum wiper resistance, R_{WL} , to be less than 50 Ω (25 Ω typ) for supply voltages down to 1.7V and allows pins H, W, and L to be driven between GND and 5.25V independent of V_{DD} . Minimal charge-pump feedthrough is present at the terminal outputs and is illustrated by the Charge-Pump Feedthrough at W vs. Frequency graph in the [Typical Operating Characteristics](#). The charge pump is on by default but can be disabled with QP_OFF and enabled with the QP_ON commands ([Table 1](#)). The MAX5394 minimum supply voltage with charge pump disabled is limited to 2.6V and terminal voltage cannot exceed -0.3V to ($V_{DD} + 0.3V$).

SPI Interface

The digital interface is powered from V_{DD} , not the internal charge-pump voltage. Therefore the V_{IH} and V_{IL} logic thresholds will follow V_{DD} as specified in the [Electrical Characteristics](#) table.

The SPI digital interface uses a 3-wire serial data interface to control the wiper tap position. This write-only interface contains three inputs: Chip Select (\overline{CS}), Data In (DIN), and Data Clock (SCLK). When \overline{CS} is taken low, data from the DIN pin is synchronously loaded into the serial shift register on each falling edge of each SCLK pulse ([Figure 3](#)). After all the data bits have been shifted in, they are latched into the potentiometer control register. Data written to a memory register immediately updates the wiper position.

Keep \overline{CS} low during the entire data stream to prevent the data from being terminated. The power-on default position of the wiper is midscale ($D[7:0] = 80H$).

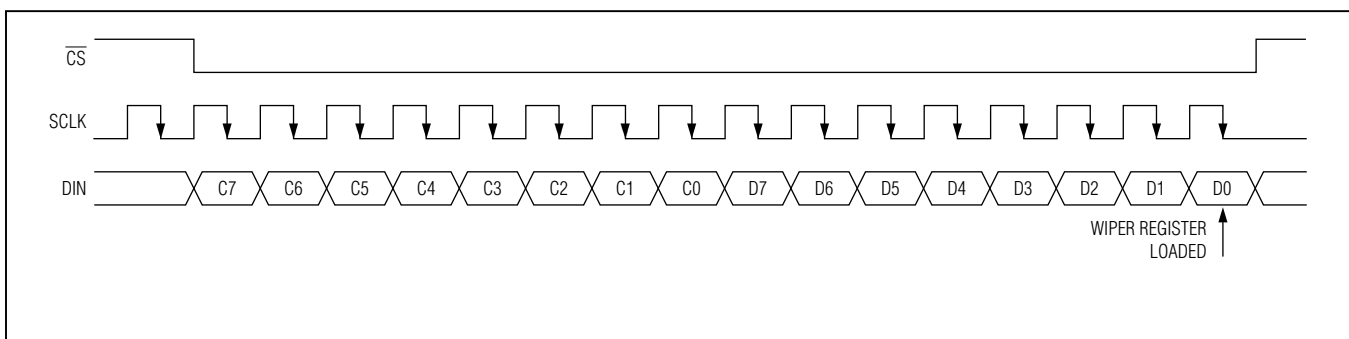

Figure 3. SPI Digital Interface Format

MAX5394

Single, 256-Tap Volatile, SPI, Low-Voltage Linear Taper Digital Potentiometer

Table 1. SPI Write Command Byte Summary

COMMAND	COMMAND BYTE								DATA BYTE							
	C7	C6	C5	C4	C3	C2	C1	C0	D7	D6	D5	D4	D3	D2	D1	D0
WIPER	0	0	0	0	0	0	0	0	D7	D6	D5	D4	D3	D2	D1	D0
SD_CLR	1	0	0	0	0	0	0	0	X	X	X	X	X	X	X	X
SD_H_WREG	1	0	0	1	0	0	0	0	X	X	X	X	X	X	X	X
SD_H_ZERO	1	0	0	1	0	0	0	1	X	X	X	X	X	X	X	X
SD_H_MID	1	0	0	1	0	0	1	0	X	X	X	X	X	X	X	X
SD_H_FULL	1	0	0	1	0	0	1	1	X	X	X	X	X	X	X	X
SD_L_WREG	1	0	0	0	1	0	0	0	X	X	X	X	X	X	X	X
SD_L_ZERO	1	0	0	0	1	0	0	1	X	X	X	X	X	X	X	X
SD_L_MID	1	0	0	0	1	0	1	0	X	X	X	X	X	X	X	X
SD_L_FULL	1	0	0	0	1	0	1	1	X	X	X	X	X	X	X	X
SD_W	1	0	0	0	0	1	X	X	X	X	X	X	X	X	X	X
QP_OFF	1	0	1	0	0	0	0	0	X	X	X	X	X	X	X	X
QP_ON	1	0	1	0	0	0	0	1	X	X	X	X	X	X	X	X
RST	1	1	0	0	0	0	0	0	X	X	X	X	X	X	X	X

WIPER Command

The data byte writes to the wiper register and the potentiometer moves to the appropriate position. D[7:0] indicates the position of the wiper. D[7:0] = 0x00 moves the wiper to the position closest to L. D[7:0] = 0xFF moves the wiper closest to H. D[7:0] = 0x80 following power-on.

SD_CLR Command

Removes any existing shutdown condition. Connects all potentiometer terminals and returns the wiper to the value stored in the wiper register. The command does not affect the current status of the charge pump.

SD_H_WREG Command

Opens the H terminal and maintains the wiper at the wiper register location. Writes cannot be made to the wiper register while shutdown mode is engaged. Clearing shutdown mode will close the H terminal and allow the wiper register to be written. A RST will also deassert shutdown mode and return the wiper to midscale (0x80). This command does not affect the charge-pump status.

SD_H_ZERO Command

Moves wiper to zero-scale position (0x00) and opens the H terminal. The wiper register remains unaltered. Writes cannot be made to the wiper register while shutdown mode is engaged. Clearing shutdown mode will return the wiper to the position contained in the wiper register

and close the H terminal. A RST will also deassert shutdown mode and return the wiper to midscale (0x80). This command does not affect the charge-pump status.

SD_H_MID Command

Moves wiper to midscale position (0x80) and opens the H terminal. The wiper register remains unaltered. Writes cannot be made to the wiper register while shutdown mode is engaged. Clearing shutdown mode will return the wiper to the position contained in the wiper register and close the H terminal. A RST will also deassert shutdown mode and return the wiper to midscale (0x80). This command does not affect the charge-pump status.

SD_H_FULL Command

Moves wiper to full-scale position (0xFF) and opens H terminal. The wiper register remains unaltered. Writes cannot be made to the wiper register while shutdown mode is engaged. Clearing shutdown mode will return the wiper to the position contained in the wiper register and close the H terminal. A RST will also deassert shutdown mode and return the wiper to midscale (0x80). This command does not affect the charge-pump status.

SD_L_WREG Command

Opens the L terminal and maintains the wiper at the wiper register location. Writes cannot be made to the wiper register while shutdown mode is engaged. Clearing shutdown mode will close the L terminal and allow wiper

MAX5394

Single, 256-Tap Volatile, SPI, Low-Voltage Linear Taper Digital Potentiometer

register to be written. A RST will also deassert shutdown mode and return the wiper to midscale (0x80). This command does not affect the charge-pump status.

SD_L_ZERO Command

Moves wiper to zero-scale position (0x00) and opens the L terminal. The wiper register remains unaltered. Writes cannot be made to the wiper register while shutdown mode is engaged. Clearing shutdown mode will return the wiper to the position contained in the wiper register and close the L terminal. A RST will also deassert shutdown mode and return the wiper to midscale (0x80). This command does not affect the charge-pump status.

SD_L_MID Command

Moves wiper to midscale position (0x80) and opens the L terminal. The wiper register remains unaltered. Writes cannot be made to the wiper register while shutdown mode is engaged. Clearing shutdown mode will return the wiper to the position contained in the wiper register and close the L terminal. A RST will also deassert shutdown mode and return the wiper to midscale (0x80). This command does not affect the charge-pump status.

SD_L_FULL Command

Moves wiper to full-scale position (0xFF) and opens the L terminal. The wiper register remains unaltered. Writes cannot be made to the wiper register while shutdown mode is engaged. Clearing shutdown mode will return the wiper to the position contained in the wiper register and close the L terminal. A RST will also deassert shutdown mode and return the wiper to midscale (0x80). This command does not affect the charge-pump status.

SD_W Command

Opens the W terminal keeping the internal tap position the same as the wiper register. Writes cannot be made to the wiper registers while shutdown mode is engaged. Clearing shutdown mode will return the wiper to the position contained in the wiper register and close W terminal. A RST will also deassert shutdown mode and return the wiper to midscale (0x80). This command does not affect the charge-pump status.

QP_ON Command

Enables the onboard charge pump to allow low-supply voltage operation. This is the power-on default condition. Low supply voltage is 1.7V.

QP_OFF Command

Disables the on-board charge pump and places device in low power mode. Low supply voltage is limited to 2.6V.

RST Command

Returns device to power-on default conditions. Resets the wiper register to midscale (0x80), enables charge pump, and deasserts any shutdown modes.

MAX5394

Single, 256-Tap Volatile, SPI, Low-Voltage Linear Taper Digital Potentiometer

Ordering Information

PART	PIN-PACKAGE	INTERFACE	TAPS	END-TO-END RESISTANCE (k Ω)
MAX5394LATA+T	8 TDFN-EP*	SPI	256	10
MAX5394MATA+T	8 TDFN-EP*	SPI	256	50
MAX5394NATA+T	8 TDFN-EP*	SPI	256	100

Note: All devices operate over the -40°C to +125°C temperature range.

+Denotes a lead(Pb)-free/RoHS-compliant package.

*EP = Exposed pad.

Chip Information

PROCESS: BiCMOS

Package Information

For the latest package outline information and land patterns (footprints), go to www.maximintegrated.com/packages. Note that a "+", "#", or "-" in the package code indicates RoHS status only. Package drawings may show a different suffix character, but the drawing pertains to the package regardless of RoHS status.

PACKAGE TYPE	PACKAGE CODE	OUTLINE NO.	LAND PATTERN NO.
8 TDFN-EP	T822+2	21-0168	90-0065

MAX5394

Single, 256-Tap Volatile, SPI, Low-Voltage Linear Taper Digital Potentiometer

Revision History

REVISION NUMBER	REVISION DATE	DESCRIPTION	PAGES CHANGED
0	7/12	Initial release	—
1	9/12	Revised the <i>Absolute Maximum Ratings</i>	2



Maxim Integrated cannot assume responsibility for use of any circuitry other than circuitry entirely embodied in a Maxim Integrated product. No circuit patent licenses are implied. Maxim Integrated reserves the right to change the circuitry and specifications without notice at any time. The parametric values (min and max limits) shown in the Electrical Characteristics table are guaranteed. Other parametric values quoted in this data sheet are provided for guidance.

Maxim Integrated 160 Rio Robles, San Jose, CA 95134 USA 1-408-601-1000

15

© 2012 Maxim Integrated Products, Inc. The Maxim logo and Maxim Integrated are trademarks of Maxim Integrated Products, Inc.