

Packages



3 pin SOT23 (suffix SO)



3 pin SIP (suffix UA)

Features and Benefits

- 3.5V to 24V Operation
 - -40°C to 150°C Superior temperature operation
 - CMOS technology
 - Low current consumption
 - Chopper-stabilized amplifier stage
 - Open drain output
 - Low sensitivity
 - Small Size-SOT23 3L or SIP 3L
- both RoHS compliant packages

Functional Block Diagram

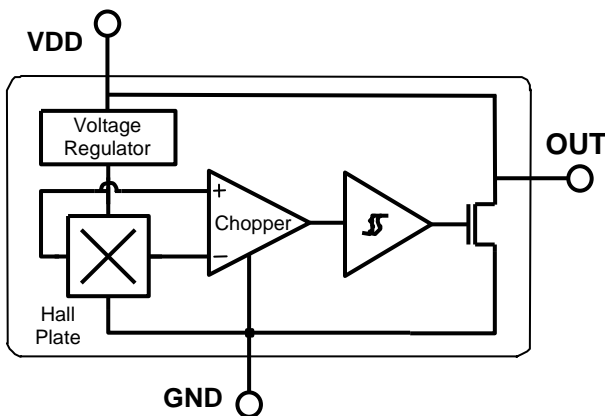

SIP Package	SOT Package
Pin 1 – V _{DD}	Pin 1 – V _{DD}
Pin 2 – GND	Pin 2 – OUT
Pin 3 – OUT	Pin 3 – GND

Application Examples

- Automotive, Consumer and Industrial
- Solid-state switch
- Brushless DC motor commutation
- Speed detection
- Angular position detection
- Proximity detection
- Current detector

General Description

The SS159 is a unipolar Hall-effect sensor IC fabricated from CMOS technology. The device integrates a voltage regulator, Hall sensor with dynamic offset cancellation system, small signal amplifier, Schmitt trigger and an open-drain output driver. With suitable output pull up, they can be used with bipolar or CMOS logic circuits.

These Hall-effect switches are monolithic integrated circuits with tighter magnetic specifications, designed to operate continuously over extended temperatures to +150°C, and are more stable with both temperature and supply voltage changes. The unipolar switching characteristic makes these devices ideal for use with a simple bar or rod magnet.

Thanks to its wide operating voltage range and extended choice of temperature range, it is quite suitable for use in automotive, industrial and consumer applications.

The device is delivered in a Small Outline Transistor (SOT) and in a Plastic Single In Line (SIP 3L flat). Both 3-lead packages are RoHS compliant.

Glossary of Terms

MilliTesla (mT), Gauss	Units of magnetic flux density: 1mT = 10 Gauss
RoHS	Restriction of Hazardous Substances
Operating Point (B_{OP})	Magnetic flux density applied on the branded side of the package which turns the output driver ON ($V_{OUT} = V_{DSON}$)
Release Point (B_{RP})	Magnetic flux density applied on the branded side of the package which turns the output driver OFF ($V_{OUT} = \text{high}$)

Pin Definitions and Descriptions

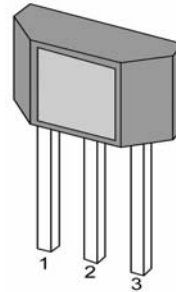
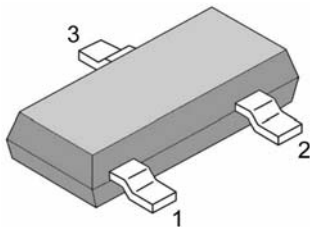

SOT Pin №	SIP Pin №	Name	Type	Function
1	1	VDD	Supply	Supply Voltage pin
2	3	OUT	Output	Open Drain Output pin
3	2	GND	Ground	Ground pin

Table 1: Pin definitions and descriptions

Absolute Maximum Ratings

Parameter	Symbol	Value	Units
Supply Voltage	V_{DD}	28	V
Supply Current	I_{DD}	50	mA
Output Voltage	V_{OUT}	28	V
Output Current	I_{OUT}	50	mA
Storage Temperature Range	T_S	-65 to 170	°C

Table 2: Absolute maximum ratings

Operating Temperature Range	Symbol	Value	Units
Temperature Suffix "E"	T_A	-40 to 85	°C
Temperature Suffix "K"	T_A	-40 to 125	°C
Temperature Suffix "L"	T_A	-40 to 150	°C

Exceeding the absolute maximum ratings may cause permanent damage. Exposure to absolute-maximum-rated conditions for extended periods may affect device reliability.

General Electrical Specifications

DC Operating Parameters $T_A = 25^\circ\text{C}$, $V_{DD} = 3.5\text{V to } 24\text{V}$ (unless otherwise specified)

Parameter	Symbol	Test Conditions	Min	Typ	Max	Units
Supply Voltage	V_{DD}	Operating	3.5		24	V
Supply Current	I_{DD}	$B < B_{RP}$	1.5	2.5	5	mA
Output Saturation Voltage	V_{DSon}	$I_{OUT} = 20\text{mA}$, $B > B_{OP}$		0.4	0.5	V
Output Leakage Current	I_{OFF}	$B < B_{RP}$ $V_{OUT} = 24\text{V}$		0.01	10	μA
Output Rise Time	t_r	$R_L = 1\text{k}\Omega$, $C_L = 20\text{pF}$		0.25		μs
Output Fall Time	t_f	$R_L = 1\text{k}\Omega$, $C_L = 20\text{pF}$		0.25		μs

Table 3: Electrical Specifications

Magnetic Specifications

DC Operating Parameters $V_{DD} = 3.5\text{V to } 24\text{V}$ (unless otherwise specified)

SS159

Parameter	Symbol	Test Conditions	Min	Typ	Max	Units
Operating Point	B_{OP}	$T_A = 25^\circ\text{C}$, $V_{DD} = 12\text{V DC}$	100	125	150	G
Release Point	B_{RP}		60	85	110	G
Hysteresis	B_{HYST}			40		G

Table 4: Magnetic Specifications

Application Information

Typical Three-Wire Application Circuit

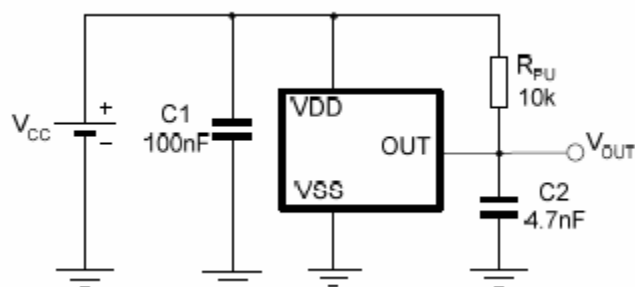

Automotive and Harsh, Noisy Environments Three-Wire Circuit

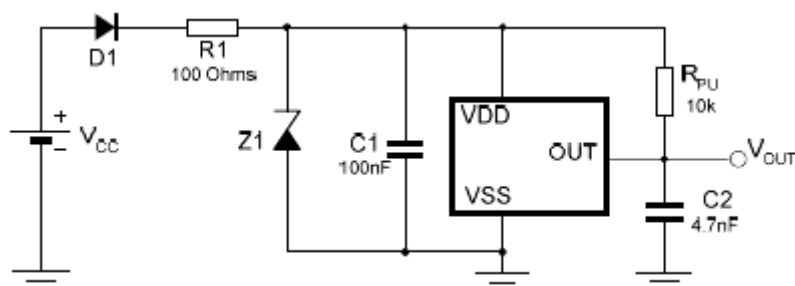

Application Comments

For proper operation, a 100nF bypass capacitor should be placed as close as possible to the device between the V_{DD} and ground pin.

For reverse voltage protection, it is recommended to connect a resistor or a diode in series with the V_{DD} pin.

When using a resistor, three points are important:

- the resistor has to limit the reverse current to 50mA maximum ($V_{CC} / R1 \leq 50\text{mA}$)
- the resulting device supply voltage V_{DD} has to be higher than $V_{DD \text{ min}}$ ($V_{DD} = V_{CC} - R1 \cdot I_{DD}$)
- the resistor has to withstand the power dissipated in reverse voltage condition ($P_D = V_{CC}^2 / R1$)

When using a diode, a reverse current cannot flow and the voltage drop is almost constant ($\approx 0.7\text{V}$).

Therefore, a 100 Ω /0.25W resistor for 5V application and a diode for higher supply voltage are recommended. Both solutions provide the required reverse voltage protection.

When a weak power supply is used or when the device is intended to be used in noisy environment, it is recommended that figure 13.3 from the Application Information section is used.

The low-pass filter formed by R1 and C1 and the Zener diode Z1 bypass the disturbances or voltage spikes occurring on the device supply voltage V_{DD} . The diode D1 provides additional reverse voltage protection.

ESD Precautions

Electronic semiconductor products are sensitive to Electro Static Discharge (ESD).

Always observe Electro Static Discharge control procedures whenever handling semiconductor products.

Package Information

Package LH, 3-Pin SOT-23:

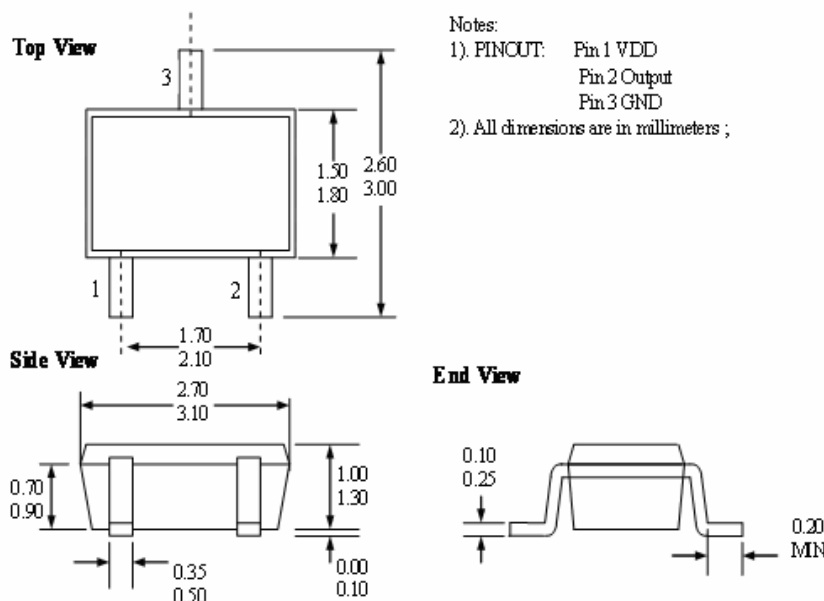

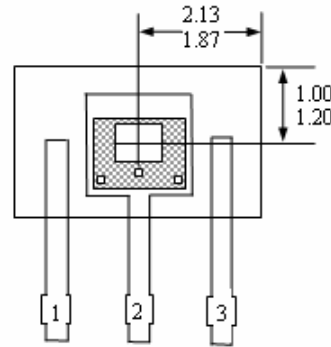
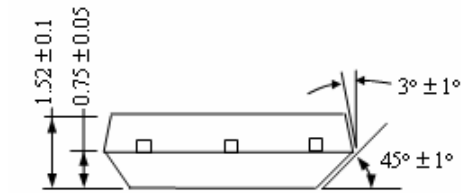
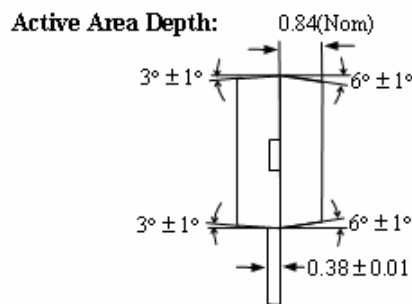
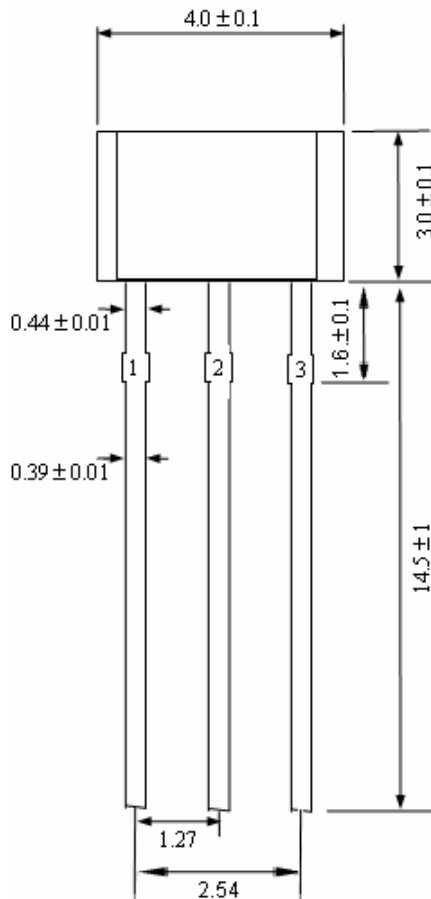
Package UA, 3-Pin SIP:

Sensor Location

Notes:

- 1). Controlling dimension : mm ;
- 2). Leads must be free of flash and plating voids ;
- 3). Do not bend leads within 1 mm of lead to package interface ;
- 4). PINOUT: Pin 1 VDD
Pin 2 GND
Pin 3 Output

Ordering Information

Part No.	Pb-free	Temperature Code	Package Code	Packing
SS159ESOT	YES	-40°C to 85°C	SOT-23	7-in. reel, 3000 pieces/reel
SS159EUA	YES	-40°C to 85°C	TO-92	Bulk, 1000 pieces/bag
SS159KSOT	YES	-40°C to 125°C	SOT-23	7-in. reel, 3000 pieces/reel
SS159KUA	YES	-40°C to 125°C	TO-92	Bulk, 1000 pieces/bag
SS159LSOT	YES	-40°C to 150°C	SOT-23	7-in. reel, 3000 pieces/reel
SS159LUA	YES	-40°C to 150°C	TO-92	Bulk, 1000 pieces/bag