

■ Mini Hi-Fi ■ Component ■ System

Operating Instructions

MHC-GT555 / GT444

MHC-GT222 / GT111

LBT-ZT4



WARNING

To reduce the risk of fire or electric shock, do not expose this apparatus to rain or moisture.

To reduce the risk of fire, do not cover the ventilation opening of the apparatus with newspapers, tablecloths, curtains, etc.

Do not place the naked flame sources such as lighted candles on the apparatus.

To reduce the risk of fire or electric shock, do not expose this apparatus to dripping or splashing, and do not place objects filled with liquids, such as vases, on the apparatus. As the main plug is used to disconnect the unit from the mains, connect the unit to an easily accessible AC outlet. Should you notice an abnormality in the unit, disconnect the main plug from the AC outlet immediately.

Do not install the appliance in a confined space, such as a bookcase or built-in cabinet.

Do not expose batteries or apparatus with battery-installed to excessive heat such as sunshine, fire or the like.

Excessive sound pressure from earphones and headphones can cause hearing loss.

CAUTION

The use of optical instruments with this product will increase eye hazard.

CLASS 1 LASER PRODUCT
LUOKAN 1 LASERLÄITE
KLASS 1 LASERAPPARAT

This appliance is classified as a CLASS 1 LASER product. This marking is located on the rear exterior.

Notice for the customers in the United States

Owner's Record

The model and serial numbers are located on the rear of the unit. Record these numbers in the space provided below. Refer to them whenever you call upon your Sony dealer regarding this product.

Model No. _____

Serial No. _____



This symbol is intended to alert the user to the presence of uninsulated "dangerous voltage" within the product's enclosure that may be of sufficient magnitude to constitute a risk of electric shock to persons.



This symbol is intended to alert the user to the presence of important operating and maintenance (servicing) instructions in the literature accompanying the appliance.

The following FCC statement applies only to the version of this model manufactured for sale in the U.S.A. Other versions may not comply with FCC technical regulations.

WARNING

This equipment has been tested and found to comply with the limits for a Class B digital device, pursuant to Part 15 of the FCC Rules. These limits are designed to provide reasonable protection against harmful interference in a residential installation. This equipment generates, uses, and can radiate radio frequency energy and, if not installed and used in accordance with the instructions, may cause harmful interference to radio communications. However, there is no guarantee that interference will not occur in a particular installation. If this equipment does cause harmful interference to radio or television reception, which can be determined by turning the equipment off and on, the user is encouraged to try to correct the interference by one or more of the following measures:

- Reorient or relocate the receiving antenna.
- Increase the separation between the equipment and receiver.
- Connect the equipment into an outlet on a circuit different from that to which the receiver is connected.
- Consult the dealer or an experienced radio/TV technician for help.

CAUTION

You are cautioned that any changes or modification not expressly approved in this manual could void your authority to operate this equipment.

Important Safety Instructions

- 1) Read these instructions.
- 2) Keep these instructions.
- 3) Heed all warnings.
- 4) Follow all instructions.
- 5) Do not use this apparatus near water.

- 6) Clean only with dry cloth.
- 7) Do not block any ventilation openings. Install in accordance with the manufacturer's instructions.
- 8) Do not install near any heat sources such as radiators, heat registers, stoves, or other apparatus (including amplifiers) that produce heat.
- 9) Do not defeat the safety purpose of the polarized or grounding-type plug. A polarized plug has two blades with one wider than the other. A grounding type plug has two blades and a third grounding prong. The wide blade or the third prong are provided for your safety. If the provided plug does not fit into your outlet, consult an electrician for replacement of the obsolete outlet.
- 10) Protect the power cord from being walked on or pinched particularly at plugs, convenience receptacles, and the point where they exit from the apparatus.
- 11) Only use attachments/accessories specified by the manufacturer.
- 12) Use only with the cart, stand, tripod, bracket, or table specified by the manufacturer, or sold with the apparatus. When a cart is used, use caution when moving the cart/apparatus combination to avoid injury from tip-over.



- 13) Unplug this apparatus during lightning storms or when unused for long periods of time.
- 14) Refer all servicing to qualified service personnel. Servicing is required when the apparatus has been damaged in any way, such as power-supply cord or plug is damaged, liquid has been spilled or objects have fallen into the apparatus, the apparatus has been exposed to rain or moisture, does not operate normally, or has been dropped.

Continued 

Notice for the customer in the countries applying EU Directives

The manufacturer of this product is Sony Corporation, 1-7-1 Konan Minato-ku Tokyo, 108-0075 Japan. The Authorized Representative for EMC and product safety is Sony Deutschland GmbH, Hedelfinger Strasse 61, 70327 Stuttgart, Germany. For any service or guarantee matters please refer to the addresses given in separate service or guarantee documents.



Disposal of Old Electrical & Electronic Equipment (Applicable in the European Union and other European countries with separate collection systems)

This symbol on the product or on its packaging indicates that this product shall not be treated as household waste. Instead it shall be handed over to the applicable collection point for the recycling of electrical and electronic equipment. By ensuring this product is disposed of correctly, you will help prevent potential negative consequences for the environment and human health, which could otherwise be caused by inappropriate waste handling of this product. The recycling of materials will help to conserve natural resources. For more detailed information about recycling of this product, please contact your local Civic Office, your household waste disposal service or the shop where you purchased the product.



Disposal of waste batteries (applicable in the European Union and other European countries with separate collection systems)

This symbol on the battery or on the packaging indicates that the battery provided with this product shall not be treated as household waste.

By ensuring these batteries are disposed of correctly, you will help prevent potentially negative consequences for the environment and human health which could otherwise be caused by inappropriate waste handling of the battery. The recycling of the materials will help to conserve natural resources.

In case of products that for safety, performance or data integrity reasons require a permanent connection with an incorporated battery, this battery should be replaced by qualified service staff only.

To ensure that the battery will be treated properly, hand over the product at end-of-life to the applicable collection point for the recycling of electrical and electronic equipment.

For all other batteries, please view the section on how to remove the battery from the product safely. Hand the battery over to the applicable collection point for the recycling of waste batteries.

For more detailed information about recycling of this product or battery, please contact your local Civic Office, your household waste disposal service or the shop where you purchased the product.

Note on DualDiscs

A DualDisc is a two sided disc product which mates DVD recorded material on one side with digital audio material on the other side. However, since the audio material side does not conform to the Compact Disc (CD) standard, playback on this product is not guaranteed.

Music discs encoded with copyright protection technologies

This product is designed to playback discs that conform to the Compact Disc (CD) standard. Recently, various music discs encoded with copyright protection technologies are marketed by some record companies. Please be aware that among those discs, there are some that do not conform to the CD standard and may not be playable by this product.

- “WALKMAN” and “WALKMAN” logo are registered trademarks of Sony Corporation.
- MICROVAULT is a trademark of Sony Corporation.
- MPEG Layer-3 audio coding technology and patents licensed from Fraunhofer IIS and Thomson.
- Windows Media is a registered trademark of Microsoft Corporation in the United States and/or other countries.

About this manual

The instructions in this manual are for models MHC-GT555, MHC-GT444, MHC-GT222, MHC-GT111 and LBT-ZT4. In this manual, the MHC-GT555 is used for illustration purposes unless stated otherwise.

The MHC-GT555 consists of:

- Unit HCD-GT555
- Speaker System
 - Front speakers SS-GT555M
 - Subwoofer SS-WG555M

The MHC-GT444 consists of:

- Unit HCD-GT444
- Speaker System
 - European model except United Kingdom and Russian only
 - Front speakers SS-GT444M
 - Subwoofer SS-WG444M
 - Other models
 - Front speakers SS-GT444
 - Subwoofer SS-WG444

The MHC-GT222 consists of:

- Unit HCD-GT222
- Speaker System
 - European model only
 - Front speakers SS-GT444M
 - Other models
 - Front speakers SS-GT444

The MHC-GT111 consists of:

- Unit HCD-GT111
- Speaker System
 - European model only
 - Front speakers SS-GT111M
 - Asian model only
 - Front speakers SS-GT111S
 - Other models
 - Front speakers SS-GT111

The LBT-ZT4 consists of:

- Unit HCD-ZT4
- Speaker System
 - Front speakers SS-ZT4
 - Subwoofer SS-WG4

Table of Contents

About this manual	5
Guide to parts and controls.....	7

Getting Started

Hooking up the system securely	13
Setting the clock	15

Basic Operations

Playing an AUDIO CD/MP3 disc	16
Listening to the radio.....	17
Transferring onto an USB device.....	18
Listening to music of an USB device.....	21
Playing a tape	23
Using optional audio components	24
Using the DIGITAL MEDIA PORT adapter	24 (LBT-ZT4 only)
Adjusting the sound.....	25
Changing the display	25

Other Operations

Creating your own program.....	27
— Program Play	
Presetting radio stations.....	28
Using the Radio Data System (RDS).....	28 (European model only)
Recording onto a tape	29
— CD-TAPE Synchro Recording/Manual Recording/ Sound Mixing	
Creating your own sound effect	30
Enjoying karaoke	30
Using the Timers	31

Others

Troubleshooting.....	33
Messages.....	37
Precautions.....	38
Specifications.....	40
Compatible USB devices with this system.....	44

Guide to parts and controls

This manual mainly explains operations using the remote, but the same operations can also be performed using the buttons on the unit having the same or similar names.

Unit

Front view

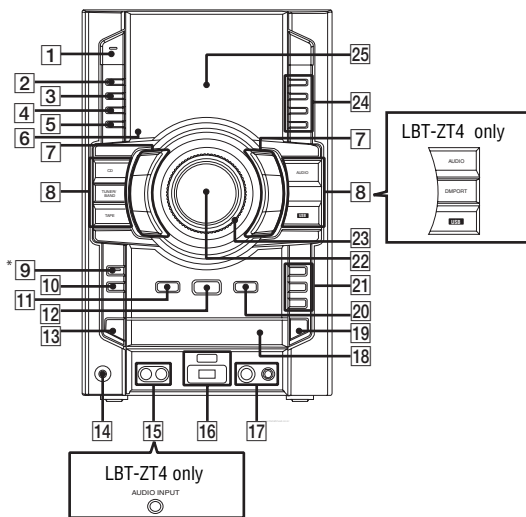

* MHC-GT555, MHC-GT444 and LBT-ZT4 only

Top view

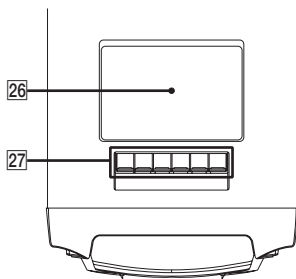

Continued

1

I/⏻ (on/standby) (pages 14, 33, 37)

Press to turn on the system.
The STANDBY indicator lights up when the system is turned off.

2

DISPLAY (pages 26, 28, 33)

Press to change the information on the display.

3

METER MODE (page 26)

Press to select the preset meter display.

4

OPTIONS (pages 19, 25)

Press to change the display, USB and MP3 BOOSTER+ settings.

5

ERASE (page 22)

Press to erase audio files and folders from the connected optional USB device.

6

Remote sensor (page 33)

7

📁 +/- (select folder) (pages 16, 22, 27)

Press to select a folder.

⏮/⏭ (rewind/fast forward)
(pages 16, 22)

Press to find a point in a track.

▶|| (play/pause) (pages 16, 21, 35)

Press to start or pause playback.

■ (stop) (pages 22, 37)

Press to stop playback.

TUNING +/- (page 17)

Press to tune in the station you want.

⏮/⏭ (go back/go forward)
(pages 16, 22, 27)

Press to select a track or file.

8

CD (pages 14, 16, 29)

Press to select the CD function.

TUNER/BAND (page 17)

Press to select the TUNER function.
Press to select the FM or AM band.

TAPE (page 23)

Press to select the TAPE function.

AUDIO (page 24)

Press to select the AUDIO function.

USB (pages 20, 21)

Press to select the USB function.

LBT-ZT4 only

DMPORT (page 24)

Press to select the DMPORT function.

9

MHC-GT555, MHC-GT444 and

LBT-ZT4 only

SUBWOOFER (page 25)

Press to turn on and off the subwoofer.
The SUBWOOFER indicator lights up when the subwoofer is turned on.

10

REC TIMER (page 32)

Press to set the Recording Timer.

11

RETURN (pages 16, 22)

Press to return to the parent folder.
Press to exit search mode.

12

ENTER (pages 16, 20, 22, 25, 32, 37)

Press to enter the settings.

13

DISC SKIP/EX-CHANGE (pages 14, 16, 27, 29)

Press to select a disc. Press to exchange a disc while playing.

14

PHONES jack

Connect the headphones.

15

LBT-ZT4 only

AUDIO INPUT jack (page 24)

Other models

AUDIO INPUT L/R jacks (page 24)

Connect to an audio component (Portable audio player, etc.).

16

 (USB) indicator

Lights up in red when transferring to the connected optional USB device or when erasing audio files or folders.

 (USB) port (pages 18, 19, 21, 35)

Connect an optional USB device.

17

MIC jack (page 30)

Connect an optional microphone.

MIC LEVEL (page 30)

Turn to adjust the microphone volume.

18

Disc tray (pages 16, 37)

19

 **OPEN/CLOSE** (page 16)

Press to insert or eject a disc.

20

REC TO  (pages 18, 19)

Press to transfer onto the connected optional USB device.

21

DISC 1 – 3 (page 16)

Press to select a disc. Press to switch to the CD function from other function.

22

MASTER VOLUME (pages 16, 17, 21, 23, 24)

Turn to adjust the volume.

23

OPERATION DIAL (pages 16, 19, 22, 25, 30, 32)

Turn to select a setting in the **OPTIONS** menu.

Turn to select a track, file or folder.

24

PRESET EQ (pages 25, 30),
GROOVE (pages 25, 30),
SURROUND (page 25)

Press to select a sound effect.

EQ BAND (page 30)

Press to select the frequency band.

25

Display (page 25)

26

Tape deck (pages 23, 29)

27

 (record) (page 29)

Press to record onto a tape.

 (play) (pages 23, 29)

Press to start tape playback.

* The  button has a tactile dot. Use the tactile dot as a reference when operating the system.

 (rewind/fast forward)

(page 23)

Press to rewind/fast forward a tape.

Continued 

■ ▲ (stop/eject) (pages 23, 29)

Press to stop tape playback.
Press to insert or eject a tape.

|| (pause) (pages 23, 29)

Press to pause tape playback.

Remote RM-AMU008 (LBT-ZT4 only)

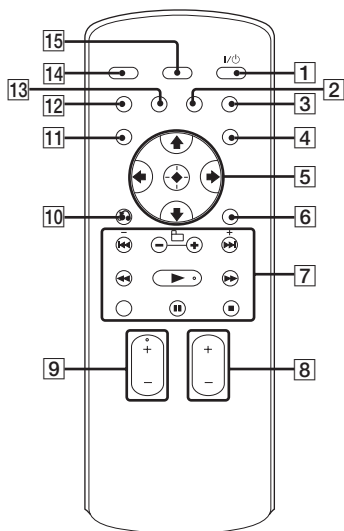

1

I/O (on/standby) (pages 15, 32)

Press to turn on the system.

2

CLEAR (page 27)

Press to delete the last step from the program list.

3

EQ (page 25)

Press to select a sound effect.

4

TIMER MENU (pages 15, 31, 32)

Press to set the clock and the timers.

5

▲/▼/▶/◀ (pages 15, 31)

Press to select the settings.

⊕ (pages 15, 27, 31)

Press to enter the selection.

6

TOOL MENU

Press to select the menu of the component connected to the DIGITAL MEDIA PORT adapter.

7

◀◀/▶▶ (go back/go forward)

(pages 16, 22, 27)

Press to select a track or file.

📁 +/- (select folder) (pages 16, 22, 27)

Press to select a folder.

+/- (tuning) (page 17)

Press to tune in the station you want.

◀◀/▶▶ (rewind/fast forward)

(pages 16, 22)

Press to find a point in a track or file.

▶ (play) (pages 16, 21, 35)

Press to start playback.

DISC SKIP (pages 16, 27, 29)

Press to select a disc.

|| (pause) (pages 16, 22)

Press to pause playback.

■ (stop) (pages 16, 17, 19, 22)

Press to stop playback.

8

FUNCTION +/- (pages 16, 17, 21, 23, 24)

Press to select a function.

9

VOLUME +/-* (pages 16, 17, 21, 23, 24)

Press to adjust the volume.

* The VOLUME + button has a tactile dot. Use the tactile dot as a reference when operating the system.

10

RETURN (pages 16, 22)

Press to return to the parent folder.

Press to exit search mode.

11

TUNER MEMORY (page 28)

Press to preset the radio station.

12

PLAY MODE/TUNING MODE
(pages 17, 22, 27, 28, 33)

Press to select the play mode of an AUDIO CD, MP3 disc or an optional USB device.

Press to select the tuning mode.

13

REPEAT/FM MODE (pages 16, 17, 22)

Press to listen to a disc, an USB device, a single track or file repeatedly.

Press to select the FM reception mode (monaural or stereo).

14

SLEEP (page 31)

Press to set the Sleep Timer.

15

DISPLAY (pages 15, 28, 33)

Press to change the information on the display.

Remote RM-AMU006

(Other models)

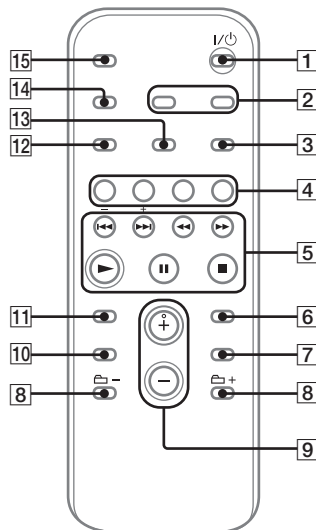
**1**

I/O (on/standby) (pages 15, 32)

Press to turn on the system.

2

CLOCK/TIMER SELECT (pages 32, 37)

CLOCK/TIMER SET (pages 15, 31)

Press to set the clock and the timers.

3

REPEAT/FM MODE (pages 16, 17, 22)

Press to listen to a disc, an USB device, a single track or file repeatedly.

Press to select the FM reception mode (monaural or stereo).

Continued 

4

USB (page 21)

Press to select the USB function.

CD (pages 16, 29)

Press to select the CD function.

TUNER/BAND (page 17)

Press to select the TUNER function.

Press to select the FM or AM band.

FUNCTION (pages 23, 24)

Press to select a function.

5

◀◀/▶▶ (go back/go forward)

(pages 15, 16, 22, 27, 31)

Press to select a track or file.

◀◀/▶▶ (rewind/fast forward)

(pages 16, 22)

Press to find a point in a track or file.

+/- (tuning) (page 17)

Press to tune in the station you want.

▶ (play) (pages 16, 21, 35)

Press to start playback.

|| (pause) (pages 16, 22)

Press to pause playback.

■ (stop) (pages 16, 17, 19, 22)

Press to stop playback.

6

ENTER (pages 15, 27, 31)

Press to enter the settings.

7

DISC SKIP (pages 16, 27, 29)

Press to select a disc.

8

📁 +/- (select folder) (pages 16, 22, 27)

Press to select a folder.

9

VOLUME +/-* (pages 16, 17, 21, 23)

Press to adjust the volume.

* The VOLUME + button has a tactile dot. Use the tactile dot as a reference when operating the system.

10

EQ (page 25)

Press to select a sound effect.

11

CLEAR (page 27)

Press to delete the last step from the program list.

12

TUNER MEMORY (page 28)

Press to preset the radio station.

13

PLAY MODE/TUNING MODE
(pages 17, 22, 27, 28, 33)

Press to select the play mode of an AUDIO CD, MP3 disc or an optional USB device.

Press to select the tuning mode.

14

DISPLAY (pages 15, 28, 33)

Press to change the information on the display.

15

SLEEP (page 31)

Press to set the Sleep Timer.

Hooking up the system securely

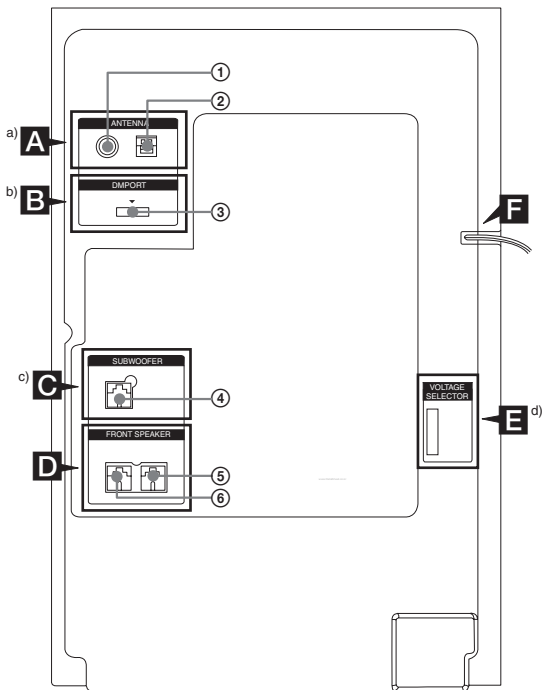

- ① To FM lead antenna
- ② To AM loop antenna
- ③ To DIGITAL MEDIA PORT adapter
- ④ To subwoofer
- ⑤ To front speaker (left)
- ⑥ To front speaker (right)

- a) The FM 75 Ω COAXIAL jack varies according to models.
- b) LBT-ZT4 only.
- c) MHC-GT555, MHC-GT444 and LBT-ZT4 only.
- d) The VOLTAGE SELECTOR varies according to models.

Continued 

A Antennas

Find a location and an orientation that provide good reception, and then set up the antennas.

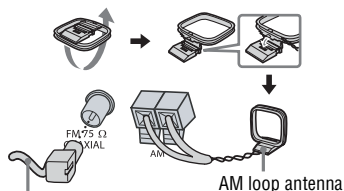

Extend the FM lead antenna horizontally

Keep the antennas away from the speaker cords, the power cord and the USB cable to avoid picking up noise.

B DMPORT (DIGITAL MEDIA PORT) (LBT-ZT4 only)

Connect the DIGITAL MEDIA PORT adapter. You need to connect the DIGITAL MEDIA PORT adapter to an optional audio device (portable audio player, etc.).

Notes

- The DIGITAL MEDIA PORT adapters are available for purchase depending on the area.
- Do not connect an adapter other than the DIGITAL MEDIA PORT adapter.
- When connecting the DIGITAL MEDIA PORT adapter, be sure the connector is inserted with the arrow mark facing towards the DMPORT jack.
- Do not connect or disconnect the DIGITAL MEDIA PORT adapter to/from the DMPORT jack while the system is turned on.
- When using a DIGITAL MEDIA PORT adapter that has video output function, connect the video output of the adapter directly to the TV.

C Subwoofer (MHC-GT555, MHC-GT444 and LBT-ZT4 only)

Be sure to insert the connector straight into the terminals.

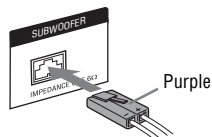

D Front speakers

Be sure to insert the connector straight into the terminals.

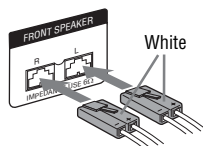

E VOLTAGE SELECTOR

For models with a voltage selector, set VOLTAGE SELECTOR to the local power line voltage.

F Power

Connect the power cord to a wall socket. The demonstration appears in the display. If the plug does not fit the wall socket, detach the supplied plug adaptor (only for models equipped with an adaptor).

When carrying this system

Use the buttons on the unit for this operation.

- 1 Remove all discs to protect the CD mechanism.
- 2 Press CD to select the CD function.
- 3 Hold down DISC SKIP/EX-CHANGE, and press I/⏻ until "STANDBY" appears.
- 4 After "MECHA LOCK" appears, unplug the power cord.

Speaker pads

Attach the supplied speaker pads to the bottom of the front speakers and subwoofer to prevent slipping.

Front speakers:

4 pads for each speaker

Subwoofer:

4 pads (MHC-GT555, MHC-GT444 and LBT-ZT4 only)

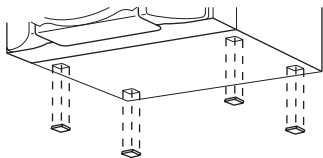

To use the remote

Slide and remove the battery compartment lid, then, insert the two supplied R6 (size AA) batteries, \ominus side first, matching the polarities shown below.

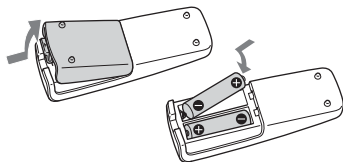

Notes

- With normal use, the batteries should last for about six months.
- Do not mix an old battery with a new one or mix different types of batteries.
- If you do not use the remote for a long period of time, remove the batteries to avoid damage from battery leakage and corrosion.

Setting the clock

You cannot set the clock in Power Saving Mode.

Use the buttons on the remote for this operation.

- 1 Press I/⏻ to turn on the system.**
- 2 Press CLOCK/TIMER SET (RM-AMU006) or TIMER MENU (RM-AMU008).**

If “PLAY SET” appears on the display, press ◀▶/▶▶ (RM-AMU006) or ▲/▼ (RM-AMU008) repeatedly to select “CLOCK SET” and then press ENTER (RM-AMU006) or ⊕ (RM-AMU008).

- 3 Press ◀▶/▶▶ (RM-AMU006) or ▲/▼ (RM-AMU008) repeatedly to set the hour, and then press ENTER (RM-AMU006) or ⊕ (RM-AMU008).**

- 4 Use the same procedure to set the minutes.**

The clock settings are lost when you disconnect the power cord or if a power failure occurs.

To display the clock when the system is turned off

Press DISPLAY repeatedly until the clock is displayed. The clock is displayed for about 8 seconds.

Basic Operations

Playing an AUDIO CD/ MP3 disc

1 Select the CD function.

Press CD (RM-AMU006) or press FUNCTION +/- (RM-AMU008) repeatedly (or press CD on the unit).

2 Place a disc.

Press \blacktriangle OPEN/CLOSE on the unit, and place a disc with the label side up on the disc tray.

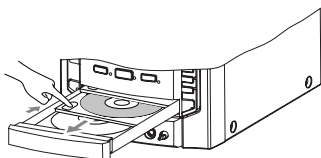

To place additional discs, slide the disc tray with your finger as shown above. To close the disc tray, press \blacktriangle OPEN/CLOSE on the unit again. Do not forcibly push the disc tray to close it as this may damage the unit.

3 Start playback.

Press \blacktriangleright (or $\blacktriangleright\parallel$ on the unit).

4 Adjust the volume.

Press VOLUME +/- (or turn MASTER VOLUME on the unit).

Other operations

To	Press
Pause playback	\parallel (or $\blacktriangleright\parallel$ on the unit). To resume play, press the button again.
Stop playback	\blacksquare .
Select a folder on an MP3 disc	Folder +/-.
Select a track or file	$\blacktriangleleft\blacktriangleright$.
Find a point in a track or file	Hold down $\blacktriangleleft/\blacktriangleright$ on the remote during playback, and release the button at the point you want.
Select Repeat Play	REPEAT repeatedly until "REP" or "REP1" lights up in the display.
Select a disc	DISC SKIP (or DISC 1 - 3 on the unit) in stop mode.
Search for an MP3 file by its folder name and file name and start playback the MP3 file (TRACK SEARCH)*	Use the controls on the unit for this operation. Turn OPERATION DIAL to select the folder you want, then press ENTER. Turn OPERATION DIAL to select the file you want, then press ENTER. To return to the parent folder, press RETURN.
Switch to CD function from other function	DISC 1 - 3 on the unit (Automatically Source Selection).
Exchange other discs while playing	EX-CHANGE on the unit.

* When using an AUDIO CD, you can use the same operation to select a track.

To change the play mode

Press PLAY MODE repeatedly in stop mode. You can select normal play (“ALL DISCS” for all discs or “1 DISC” for a disc or “*” for all MP3 files in the folder on the disc), shuffle play (“ALL DISCS SHUF” or “1 DISC SHUF” or “ SHUF*”), or program play (“PGM”).

* When playing an AUDIO CD, (SHUF) Play performs the same operation as 1 DISC (SHUF) Play and performs the same operation as 1 DISC Play.

Notes on Repeat Play

- “REP” indicates all tracks or files on a disc are played repeatedly up to five times.
- “REP1” indicates that a single track or file is repeated until you stop it.
- You cannot select “REP” and “ALL DISCS SHUF” at the same time.

Notes on playing MP3 discs

- Do not save other types of files or unnecessary folders on an MP3 disc.
- Folders that have no MP3 files are skipped.
- The system can only play MP3 files that have a file extension of “.mp3”.
- If there are files on the disc that have the “.mp3” file extension, but that are not MP3 files, the unit may produce noise or may malfunction.
- The system can recognize up to
 - 256 folders (including root folder).
 - 511 MP3 files.
 - 512 MP3 files and folders on a single disc.
 - 8 folder levels (tree structure of files).
- Compatibility with all MP3 encoding/writing software, recording device, and recording media cannot be guaranteed. Incompatible MP3 discs may produce noise or interrupted audio or may not play at all.

Notes on playing multisession discs

When you play back Multi Session discs with different formats for each session, the format of the first session is recognized as the disc type. Tracks or files in the second and subsequent sessions are played back if they are the same formats as the first session.

Listening to the radio

1 Select “FM” or “AM”.

Press TUNER/BAND (RM-AMU006) or press FUNCTION +/- (RM-AMU008) (or press TUNER/BAND on the unit) repeatedly.

2 Select the tuning mode.

Press TUNING MODE repeatedly until “AUTO” lights up in the display.

3 Tune in the station you want.

Press +/- (or TUNING +/- on the unit). Scanning stops automatically when a station is tuned in, and then “TUNED” and “ST” (for stereo programs only) light up in the display.



4 Adjust the volume.

Press VOLUME +/- (or turn MASTER VOLUME on the unit).

To stop automatic scanning

Press .

To tune in a station with a weak signal

If the scanning does not stop, press TUNING MODE repeatedly until “AUTO” and “PRESET” light off in the display, and then press +/- (or TUNING +/- on the unit) repeatedly to tune in the station you want.

To reduce static noise on a weak FM stereo station

Press FM MODE repeatedly until “MONO” lights up in the display to turn off stereo reception.

Transferring onto an USB device

You can connect an optional USB device to the  (USB) port on the unit and transfer music from a sound source (including connected audio components) to the USB device.

The audio format of files transferred by this system is MP3.

The approximate size of the transferring is about 1 MB per minute of transferring time from an AUDIO CD, tape, tuner, optional audio component or component connected to the DIGITAL MEDIA PORT adapter. When transferring from an MP3 disc, the file size is the same as the original file.

See “Compatible USB devices with this system” (page 44) for a list of USB devices that can be connected to this system.

CD-USB Synchronized Transfer

You can easily transfer an entire disc onto an USB device.

- 1 Connect a transferable USB device to the  (USB) port as shown below.**

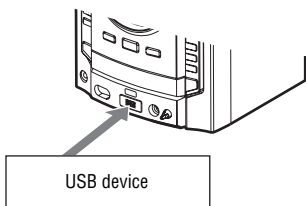

When the USB cable connection is necessary, connect the USB cable supplied with the USB device to be connected.

Refer to the operation manual supplied with the USB device to be connected for details on the operation method.

- 2 Select the CD function, then load the disc you want to transfer.**
- 3 Press PLAY MODE repeatedly in stop mode to select the play mode.**

The play mode automatically changes to normal play mode, if you start transferring in shuffle play mode, repeat play mode or in program play mode (when no tracks or MP3 files are programmed).

For details about the play mode, see “To change the play mode” (page 17).

- 4 Press REC TO  on the unit.** “USB”, “SYNC” and “REC” light up in the display. Then, transferring starts when “DON’T REMOVE” appears in the display. When the transferring is completed, the disc and the USB device stop automatically.

Transferring a single track or MP3 file during playback (REC1 Transferring)

You can easily transfer the track or MP3 file that is currently being played back onto an USB device.

- 1 Connect a transferable USB device to the  (USB) port on the unit.**
- 2 Select the CD function, then load the disc you want to transfer.**
- 3 Select the track or MP3 file you want to transfer, then start play.**

4 Press REC TO **USB** on the unit while the selected track or MP3 file is being played back.

“USB” and “REC” light up in the display. Then, transferring starts from the beginning of the track or file when “DON’T REMOVE” appears in the display. When the transferring is completed, the disc continues to play.

Transferring from a sound source other than disc (Analog Transferring)

You can easily transfer from a tape, tuner, optional audio component or component connected to the DIGITAL MEDIA PORT adapter onto a USB device.

1 Connect a transferable USB device to the (USB) port on the unit.

2 Select the source you want to transfer.

For tape, insert a tape. For tuner, tune in the station you want to transfer.

3 Start play back the source.

4 Press REC TO **USB** on the unit.

“USB” and “REC” light up in the display. Then, transferring starts when “DON’T REMOVE” appears in the display.

Tips

- A new MP3 file is created automatically after approximately 1 hour of transferring.
- Transferring stops automatically when you change the function or tuner band.

To stop transferring

Press .

To create a new MP3 file

Press REC TO **USB** on the unit. “NEW TRACK” appears in the display. If you press REC TO **USB** again after a few seconds, “NOT IN USE” appears in the display and a new MP3 file cannot be created.

To transfer sound from a microphone

- 1 Press FUNCTION (RM-AMU006) or FUNCTION +/- (RM-AMU008) repeatedly (or press TAPE on the unit) to select the TAPE function, and do not start playing any tape.
- 2 Press REC TO **USB** on the unit.
- 3 Start singing or speaking into the microphone.

To select the playback source or transferring destination on a Sony Ericsson mobile phone

When listening to music from a Sony Ericsson mobile phone or when transferring music from this system to the mobile phone, you can select the playback source or transferring destination as follows:

- internal memory of the mobile phone.
- external memory (such as Memory Stick, etc.).

1 Connect the mobile phone to the (USB) port on the unit.

2 Press OPTIONS on the unit in stop mode.

3 Turn OPERATION DIAL on the unit to select “USB SELECT”.

Continued 

4 Press ENTER on the unit.

The drive name of the mobile phone appears in the display but varies depending on the specification of the mobile phone.

5 Turn OPERATION DIAL on the unit to select the drive you want.

6 Press ENTER on the unit.

7 Start playback of the audio files in the selected drive of the mobile phone or start transferring.

To remove the USB device

Use the buttons on the unit for this operation.

1 Press **USB** to select the USB function.

2 Hold down **■** in stop mode until "NO DEVICE" appears.

3 Remove the USB device.

Folder and file generation rules

When transferring to an USB device, a "MUSIC" folder is created directly below the "ROOT". Folders and files are generated within this "MUSIC" folder as follows according to the transferring method and source.

CD-USB Synchronized Transfer¹⁾

Transfer- ring source	Folder name	File name
MP3	Same as the transferring source ²⁾	
AUDIO CD	"CDDA001" ³⁾	"TRACK001" ⁴⁾

REC1 Transferring

Transfer- ring source	Folder name	File name
MP3	"REC1" ⁵⁾	Same as the transferring source ²⁾
AUDIO CD		"TRACK001" ⁴⁾

Analog Transferring

Transfer- ring source	Folder name	File name
FM	"TUFM001" ³⁾	"TRACK001" ⁴⁾
AM	"TUAM001" ³⁾	
TAPE	"TAPE001" ³⁾	
AUDIO	"EXAU001" ³⁾	
DMPort	"EXDP001" ³⁾	

1) In Program Play mode, the folder name is "PGM_XXX", and the file name depends on the transferring source (AUDIO CD or MP3 disc).

2) Up to 32 characters of the name are assigned.

3) Folder numbers are assigned serially thereafter.

4) File numbers are assigned serially thereafter.

5) A new file is transferred in the "REC1" folder each time REC1 Transferring is performed.

Notes

- Do not connect the system and the USB device through an USB hub.
- When transferring from an AUDIO CD, the tracks are transferred as 128 kbps MP3 files. When transferring from an MP3 disc, MP3 files are transferred with the same bit rate as the original MP3 files.
- When transferring from a source other than disc, the files are transferred as 128 kbps MP3 files.
- While transferring from an MP3 disc, no sound is output.
- CD-TEXT information is not transferred in the created MP3 files.
- If you cancel the transferring partway, an MP3 file is created up to the point when the transferring was stopped.
- Transferring stops automatically if:
 - the USB device runs out of space during transferring.
 - the number of audio files on the USB device reaches the limit for the number that the system can recognize.
 - the function or tuner band is changed.
- Up to 999 audio files or 997 folders can be transferred on a single USB device. The maximum number of audio files and folders may vary depending on the audio file and folder structure.
- If a folder or file that you are trying to transfer already exists on the USB device with the same name, a sequential number is added after the name without overwriting the original folder or file.
- Do not remove the USB device during transferring or erase operations. Doing so may corrupt the data on the USB device or damage the USB device itself.
- You cannot eject the disc, select another disc, track or file, pause playback or find a point in the track or file during CD-USB Synchronized Transfer or REC1 Transferring.

Listening to music of an USB device

You can listen to music stored in the USB device.

The audio formats that can be played back by this system are MP3, AAC and WMA only.*

See “Compatible USB devices with this system” (page 44) for a list of USB devices that can be connected to this system.

* Files with copyright protection (Digital Rights Management) cannot be played by this system. Files downloaded from an online music store may not be played on this system.

1 Select the USB function.

Press USB (RM-AMU006) or press FUNCTION +/- (RM-AMU008) repeatedly (or press **USB** on the unit).

2 Connect an optional USB device to the (USB) port on the unit.

– When the USB device is connected, the display changes as follows:
“USB READING” → Volume label*

* “STORAGE DRIVE” appears when there is no volume label assigned to the USB device. “WALKMAN” appears if the USB device is the supported Sony digital music player.

Note

It may take some time before “USB READING” appears depending on the type of USB device connected.

3 Start playback.

Press **▶** (or **▶||** on the unit).
The files are played in alphabetical order.

4 Adjust the volume.

Press VOLUME +/- (or turn MASTER VOLUME on the unit).

Continued 



To remove the USB device

Use the buttons on the unit for this operation.

- 1 Press **USB** to select the USB function.
- 2 Hold down **■** in stop mode until “NO DEVICE” appears.
- 3 Remove the USB device.

To erase audio files or folders from the USB device

You can erase audio files or folders from the USB device.

- 1 Connect a transferable USB device to the  (USB) port on the unit.
- 2 Select the USB function.
- 3 Press **◀◀/▶▶** or  +/- repeatedly to select the audio file or folder you want to erase.
- 4 Press ERASE on the unit. “TRACK ERASE” or “FOLDER ERASE”, and “PUSH ENTER” appear alternately in the display. To cancel the erase operation, press **■**.
- 5 Press ENTER. The selected audio file or folder is erased.

Other operations

To	Press
Pause playback	 (or ▶ on the unit). To resume play, press the button again.
Stop playback	■ . To resume play, press ▶ (or press ▶ on the unit). ¹⁾ To cancel resume play, press the button twice and check that “RESUME” disappears from the display.



To	Press
Select a folder	 +/-.
Select a file	◀◀/▶▶ .
Search for an audio file by its folder name and file name and start playback the audio file (TRACK SEARCH)	Use the controls on the unit for this operation. Turn OPERATION DIAL to select the folder you want, then press ENTER. Turn OPERATION DIAL to select the file you want, then press ENTER. To return to the parent folder, press RETURN.
Find a point in a file	Hold down ◀◀/▶▶ on the remote during playback, and release the button at the point you want.
Select Repeat Play	REPEAT repeatedly until “REP” or “REP1” lights up in the display.

¹⁾ When playing an VBR (variable bit rate) audio file, the system may resume playback from a different point.

To change the play mode

Press PLAY MODE repeatedly while the USB device is stopped.

You can select

- Normal play (all files in the folder on the USB device) (“” lights up).
- Normal play (all files on the USB device) (“”, “SHUF” and “PGM” light off).
- Shuffle play (“SHUF” or “ SHUF” lights up).
- Program play (“PGM” lights up).

Notes on the USB device

- You cannot change the play mode during playback.
- Some time may be needed to start playback when:
 - the folder structure is complex.
 - the memory capacity is excessive.

- When the USB device is inserted, the system reads all the files on the USB device. If there are many folders or files on the USB device, it may take a long time to finish reading the USB device.
- Do not connect the system and the USB device through an USB hub.
- With some connected USB devices, after an operation is performed, there may be a delay before it is performed by this system.
- If the system is turned off during Resume Play mode, when the system is turned on again playback starts from the beginning of the audio file.
- This system does not necessarily support all the functions provided in a connected USB device.
- The playback order for the system may differ from the playback order of the connected digital music player.
- Do not save other types of files or unnecessary folders on an USB device.
- Folders that have no audio files are skipped.
- The maximum number of audio files and folders on an USB device that can be recognized by this system is 999 (including "ROOT" and "MUSIC" folder). The maximum number of audio files and folders may vary depending on the file and folder structure.
- The system can play the following format of audio files:
 - MP3 with file extension ".mp3".
 - AAC with file extension ".m4a".
 - Windows Media Audio (WMA) with file extension ".wma".
 If the audio files have the above file extension but are not the respective formats, the system may produce noise or may malfunction.
- Compatibility with all MP3, AAC or WMA encoding/writing softwares, recording devices, and recording media cannot be guaranteed. Incompatible USB device may produce noise or interrupted audio or may not play at all.
- You cannot erase audio files and folders in shuffle play mode or program play mode.
- If the folder to be erased does not contain MP3/AAC/WMA files or contains sub folders, these are not erased.
- The Program Play setting is erased when the erase operation is performed.

Playing a tape

Use the controls on the tape deck for this operation.

1 Select the TAPE function.

Press FUNCTION (RM-AMU006) or FUNCTION +/- (RM-AMU008) repeatedly (or press TAPE on the unit).

2 Insert a tape.

Press **■ ▲**, and insert a TYPE I (normal) tape into the tape holder with the side you want to play facing up. Make sure there is no slack in the tape to avoid damaging the tape or the tape deck. Press the tape deck lid on the unit to close the tape holder.

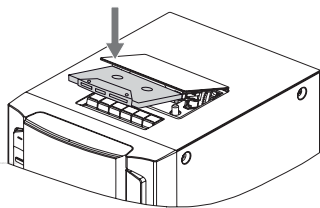

3 Start playback.

Press **▶**.

4 Adjust the volume.

Press VOLUME +/- (or turn MASTER VOLUME on the unit).

Other operations

To	Press
Pause playback	 . To resume play, press the button again.
Stop playback	■ ▲ .
Rewind or fast forward	◀◀▶▶ .

Using optional audio components

1 Connect an optional audio component to the unit.

LBT-ZT4 only:

Connect to the AUDIO INPUT jack on the unit using a stereo mini-plug cord (not supplied).

Other models:

Connect to the AUDIO INPUT L/R jacks on the unit using an audio cord (not supplied).

2 Turn down the volume.

Press VOLUME – (or turn MASTER VOLUME on the unit counter clockwise).

3 Select the AUDIO function.

Press FUNCTION (RM-AMU006) or FUNCTION +/- (RM-AMU008) repeatedly (or press AUDIO on the unit).

4 Start playing the connected component.

5 Adjust the volume.

Press VOLUME +/- (or turn MASTER VOLUME on the unit).

Using the DIGITAL MEDIA PORT adapter

(LBT-ZT4 only)

1 Select the DMPORT function.

Press FUNCTION +/- repeatedly (or press DMPORT on the unit).

2 Start playing the component connected to the DIGITAL MEDIA PORT adapter.

The sound from the connected component is played on the system. For operation details, refer to the operating instructions of the DIGITAL MEDIA PORT adapter.

Notes

- Depending on the type of DIGITAL MEDIA PORT adapter, you may be able to operate the connected component using the buttons on the remote or the unit.
- You can use the system to charge the battery of the audio device connected to the DIGITAL MEDIA PORT adapter while the system is turned on.

Adjusting the sound

Use the controls on the unit for this operation.

To add a sound effect

To	Press
Reinforce the bass and create a more powerful sound	GROOVE repeatedly until "GROOVE"* or "Z-GROOVE"* lights up in the display.
Select the surround effect	SURROUND repeatedly until "SURROUND" lights up in the display.
Select a preset sound effect	PRESET EQ (or EQ on the remote) repeatedly. To cancel, press PRESET EQ (or EQ on the remote) repeatedly until "FLAT" appears.
Enhance the sound quality of the audio file	OPTIONS and turn OPERATION DIAL to select "MP3 BOOSTER+", then press ENTER. Turn OPERATION DIAL to select "AUTO", then press ENTER. **

* The volume switches to power mode and the equalizer curve changes.

**"BOOSTER" lights up in the display when the MP3 BOOSTER+ effect is activated.

To turn on the subwoofer (MHC-GT555, MHC-GT444 and LBT-ZT4 only)

Press SUBWOOFER repeatedly until the SUBWOOFER indicator on the unit lights up. If you later disconnect the subwoofer, repeat the procedure until the SUBWOOFER indicator on the unit lights off. The volume of the subwoofer is linked to the front speakers.

Changing the display

Use the controls on the unit for this operation.

- 1 Press **OPTIONS**.
- 2 Turn **OPERATION DIAL** to select the item you want.

ILLUM

Change the power illuminator pattern around MASTER VOLUME.

M-BACKLIGHT (Meter backlight)

Change the Meter Backlight pattern.

MTR POINTER (Meter pointer)

Change the Meter Pointer pattern.

DISPLAY (Front panel display)

Change the front panel display pattern.

- 3 Press **ENTER**.
- 4 Turn **OPERATION DIAL** to select the setting you want, then press **ENTER**.
- 5 Repeat steps 2 through 4 to make other settings.

To exit the OPTIONS menu

Press **OPTIONS** again.

To return to the previous display

Press **RETURN**.

Changing the display mode

Press DISPLAY repeatedly while the system is turned off.

Demonstration

The display changes and the indicator flashes even when the system is turned off.

No display (Power Saving mode)

The display is turned off to conserve power. The timer and clock continue to operate. You cannot turn on the system by pressing the function buttons.

Clock

The clock is display.

The clock display automatically turns to Power Save Mode after 8 seconds.

Changing information in the display

Press DISPLAY repeatedly when the system is turned on.

You can view the elapsed playing time and remaining playing time during playback and total playing time during stop mode for AUDIO CD.

For audio files, you can view the elapsed playing time, the file and folder names. You can also view the title, artist and album information that is stored in the files.

Notes on the display information

- Characters that cannot be displayed appear as “ ”.
- The following are not display correctly:
 - elapsed playing time of an audio file encoded using a VBR (variable bit rate).
 - folder and file names that do not follow either the ISO9660 Level 1, Level 2 or Joliet in the expansion format.
- The ID3 tag information for MP3 files is displayed when ID3 version 1 and version 2 tags are used (ID3 version 2 tag information display has priority when both ID3 version 1 and version 2 tags are used for a single MP3 file).

Using the Meter Display

You can easily view the information through the meter display such as the music source level.

Press METER MODE repeatedly to select a preset display pattern.

The power illuminator, meter backlight display, meter pointer display and front panel display will change according to the preset display pattern you have selected.

Other Operations

Creating your own program

— Program Play

1 Select the function you want.

CD function

Press CD (RM-AMU006) or press FUNCTION +/- (RM-AMU008) repeatedly to select the CD function.

USB function

Press USB (RM-AMU006) or press FUNCTION +/- (RM-AMU008) repeatedly to select the USB function.

2 Press PLAY MODE repeatedly in stop mode until “PGM” lights up in the display.

3 For CD function, press DISC SKIP repeatedly (or press DISC 1 – 3 on the unit) to select a disc.

To program all the tracks on a disc at once, proceed to step 5 while “ALL” appears in the display.

To program all the MP3 files on a folder at once, press  +/- repeatedly until the folder you want appears in the display, then proceed to step 5.

4 Press / repeatedly until the track or file number you want appears.

When programming audio files, press  +/- repeatedly to select the folder you want, and then select the file you want.

Disc tray number



Total playing time of program
(including selected track or file)

5 Press ENTER (RM-AMU006) or (RM-AMU008) to add the track or file to the program.

CD function

“-- --” appears when the total program time exceeds 100 minutes for an AUDIO CD or when you select an MP3 file.

USB function

The total program time cannot be displayed, so “-- --” appears.

6 Repeat steps 3 through 5 to program additional tracks, files, folders or discs up to a total of 25 steps.

7 To play your program of tracks or files, press .

The program remains available until you open the disc tray or remove the USB device. To play the same program again, press .

To cancel Program Play

Press PLAY MODE repeatedly in stop mode until “PGM” lights off in the display.

To delete the last step of the program

Press CLEAR in stop mode.

Presetting radio stations

You can preset your favorite radio stations and tune them in instantly by selecting the corresponding preset number.

Use the buttons on the remote for this operation.

1 Tune in the station you want (see “Listening to the radio” (page 17)).

2 Press **TUNER MEMORY**.

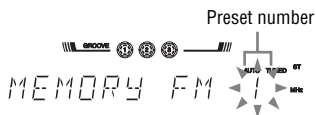

3 Press **+/-** repeatedly to select the preset number you want.

If another station is already assigned to the selected preset number, the station is replaced by the new station.

4 Press **ENTER**.

5 Repeat steps 1 through 4 to store other stations.

You can preset up to 20 FM and 10 AM stations.

6 To call up a preset radio station, press **TUNING MODE** repeatedly until “PRESET” lights up in the display, and then press **+/-** repeatedly to select the preset number you want.

Using the Radio Data System (RDS)

(European model only)

What is the Radio Data System?

Radio Data System (RDS) is a broadcasting service that allows radio stations to send additional information along with the regular program signal. This tuner offers convenient RDS features such as station name. RDS is available only on FM stations.*

Note

RDS may not work properly if the station you are tuned in is not transmitting the RDS signal properly or if the signal is weak.

* Not all FM stations provide RDS service, nor do they provide the same type of services. If you are not familiar with the RDS system, check with your local radio stations for details on RDS services in your area.

Receiving RDS broadcasts

Simply select a station from the FM band.

When you tune in a station that provides RDS services, the station name appears in the display.

To check the RDS information

While receiving an RDS station, press **DISPLAY** repeatedly.

RDS information appears on the display.

Recording onto a tape

— CD-TAPE Synchro Recording/Manual Recording/Sound Mixing

You can record on a TYPE I (normal) tape in three ways:

CD-TAPE Synchro Recording:

You can record an entire disc onto a tape.

Manual Recording:

You can record just the portions you like from a sound source, including connected audio components.

Sound Mixing:

You can “mix” sounds by playing one of the components and singing or speaking into a microphone (not supplied). The mixed sound can be recorded onto a tape.

1 Load a recordable tape into the tape deck with the side you want to record facing up.

2 Prepare the recording source.

Select the source you want to record.

CD-TAPE Synchro Recording

Press CD (RM-AMU006) or press FUNCTION +/- (RM-AMU008) repeatedly (or press CD on the unit) to select the CD function. Load the disc you want to record, and press DISC SKIP repeatedly to select the disc.

To select the play mode, press PLAY MODE repeatedly in stop mode (see “To change the play mode” (page 17)).

To record your favorite CD tracks or MP3 files in the order you want, perform steps 2 to 6 of “Creating your own program” (page 27).

Manual Recording and Sound Mixing

To record sound from a microphone, press CD (RM-AMU006) or press FUNCTION +/- (RM-AMU008) repeatedly (or press CD on the unit) to select the CD function, and do not start playing any disc in step 3.

3 Start recording.

Press ● and ► on the tape deck at the same time.

CD-TAPE Synchro Recording

The disc starts playing automatically after 10 seconds.

Manual Recording and Sound Mixing

Start playing the recording source. If there is noise while recording from the tuner, reposition the antenna to reduce the noise.

While recording, you cannot listen to other sources. Otherwise, recording stops.

To stop recording

Press ■ ▲ on the tape deck.

Notes

- We recommend that you press ■ on the tape deck first, then press ■ ▲ on the tape deck to avoid noise being recorded when you stop recording.
- You cannot eject the disc, select another disc, track or file, pause playback or find a point in the track or file during CD-TAPE Synchro Recording.

Creating your own sound effect

You can raise or lower the levels of specific frequency ranges or select the surround effect, and then store the setting as “USER EQ” in the memory. Use the buttons on the unit for this operation.

- 1 Press PRESET EQ or GROOVE repeatedly to select the audio emphasis you want for your basic sound.**
- 2 Press EQ BAND repeatedly to select a frequency band or surround effect setting, and then turn OPERATION DIAL to adjust the equalizer level or select the surround effect you want. Repeat this for each band you want to adjust.**

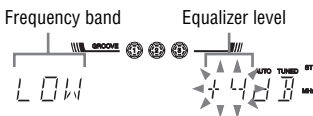

- 3 Press ENTER.**

“USER EQ” appears and the setting is stored in the memory.

To call up the personal sound effect

Press PRESET EQ repeatedly until “USER EQ” appears.

To cancel the sound effect

Press PRESET EQ repeatedly until “FLAT” appears.

Enjoying karaoke

You can sing along by connecting an optional microphone.

- 1 Turn MIC LEVEL on the unit to MIN to turn down the microphone volume level.**
- 2 Connect an optional microphone to the MIC jack on the unit.**
- 3 Start playing the music.**
- 4 Turn MIC LEVEL on the unit to adjust the microphone volume.**

If acoustic feedback (howling) occurs, reduce the volume, move the microphone away from the speakers, or change the direction of the microphone.

After you have finished, disconnect the microphone from the MIC jack on the unit.

Using the Timers

The system offers three timer functions. You cannot activate both the Play Timer and the Recording Timer at the same time. If you use either with the Sleep Timer, the Sleep Timer has priority.

Sleep Timer

You can fall asleep to music. This function works even if the clock is not set.

Press SLEEP repeatedly.

If you select "AUTO", the system automatically turns off

- after the disc stops or after 100 minutes in CD function.
- after the USB device stops or after 100 minutes in USB function.
- after 100 minutes in other functions.

Do not select "AUTO" during CD-TAPE Synchro Recording, CD-USB Synchronized Transfer, or during the erase operation.

Tip

The system will not turn off automatically at the preset time when you

- perform the erase operation in USB function.
- play a tape.
- record onto a tape.

Play Timer/Recording Timer

Make sure you have set the clock.

Play Timer:

You can wake up to disc, tuner or optional USB device at a preset time.

Recording Timer:

You can transfer music from a preset radio station into an USB device at a specified time.

1 Prepare the sound source.

Play Timer

Prepare the sound source, and then press VOLUME +/- to adjust the volume.

To start from a specific track or file, create your own program (page 27).

Recording Timer

Tune in the preset radio station (page 28).

2 Press CLOCK/TIMER SET (RM-AMU006) or TIMER MENU (RM-AMU008).

3 Press ◀◀/▶▶ (RM-AMU006) or ↓/↑ (RM-AMU008) repeatedly to select "PLAY SET" or "REC SET", and then press ENTER (RM-AMU006) or ⊕ (RM-AMU008).

"ON" appears, and the hour indication flashes.

4 Set the time to start playing or recording.

Press ◀◀/▶▶ (RM-AMU006) or ↓/↑ (RM-AMU008) repeatedly to set the hour, and then press ENTER (RM-AMU006) or ⊕ (RM-AMU008). The minute indication flashes. Use the procedure above to set the minutes.

5 Use the same procedure as in step 4 to set the time to stop playing or recording.

Continued 

6 Select the sound source or prepare the USB device.

Play Timer

Press **◀◀/▶▶** (RM-AMU006) or **↓/↑** (RM-AMU008) repeatedly until the sound source you want appears, and then press **ENTER** (RM-AMU006) or **⊕** (RM-AMU008). The display shows the timer settings.

Recording Timer

Connect a transferable USB device to the **↔** (USB) port on the unit. The display shows the timer settings.

7 Press **I/⏻** to turn off the system.

To set the Recording Timer using the controls on the unit (REC TIMER)

- 1 Tune in the preset station (page 28).
- 2 Press **REC TIMER**.
“ON” appears, and the hour indication flashes.
- 3 Turn **OPERATION DIAL** to set the hour, then press **ENTER**.
The minute indication flashes. Use the procedure above to set the minutes.
- 4 Use the same procedure as in step 3 to set the time to stop recording.
The display shows the timer settings.
- 5 Connect a transferable USB device to the **↔** (USB) port on the unit.
- 6 Press **I/⏻** to turn off the system.

To activate or check the timer again

RM-AMU006:

Press **CLOCK/TIMER SELECT**, press **◀◀/▶▶** repeatedly until “PLAY SELECT” or “REC SELECT” appears, and then press **ENTER**.

RM-AMU008:

Press **TIMER MENU** to select “TIMER SELECT”, then press **⊕**. Press **↓/↑** repeatedly until “PLAY SELECT” or “REC SELECT” appears, and then press **⊕**.

Unit:

Press **REC TIMER**, turn **OPERATION DIAL** until “REC SELECT” appears, and then press **ENTER**.

To cancel the timer

Repeat the same procedure as above until “TIMER OFF” appears, and then press **ENTER** (RM-AMU006 or on the unit) or **⊕** (RM-AMU008).

To change the setting

Start over from step 1.

Tips

- The system turns on before the preset time. If the system is turned on at the preset time or if “STANDBY” flashes in the display, the Play Timer and the Recording Timer will not play or record.
- The Play Timer setting remains as long as the setting is not canceled manually.
- The volume is reduced to minimum during the Recording Timer.
- The Recording Timer is canceled automatically after the Recording Timer has been activated.

Troubleshooting

- 1 Make sure the power cord and speaker cords are correctly and firmly connected.
- 2 Find your problem in the checklist below, and take the indicated corrective action.
If the problem persists, contact your nearest Sony dealer.
Note that if service personnel changes some parts during repair, these parts may be retained.

If the STANDBY indicator flashes

Immediately unplug the power cord, and check the following items.

- If your system has a voltage selector, is the voltage selector set to the correct voltage?
- Are you using only the supplied speakers?
- Is anything blocking the ventilation holes on the back of the unit?

After checking the above items and fixing any problems, plug in the power cord again and turn on the system. If the STANDBY indicator still flashes, or if the cause of the problem cannot be found even after checking all the above items, consult your nearest Sony dealer.

General

The display starts flashing as soon as you plug in the power cord even though you have not turned on the system.

- Press DISPLAY once while the system is turned off. The demonstration disappears.

Sound comes from one channel, or the left and right volumes are unbalanced.

- Place the speakers as symmetrically as possible.
- Connect only the supplied speakers.

Severe hum or noise.

- Move the system away from sources of noise.
- Connect the system to a different wall socket.
- Install a noise filter (available separately) to the power cord.
- Turn off the surrounding electrical equipment.

The remote does not function.

- Remove any obstacles between the remote and the remote sensor on the unit, and position the unit away from fluorescent lights.
- Point the remote at the system's sensor.
- Move the remote closer to the system.

CD/MP3 player

The sound skips, or the disc will not play.

- Wipe the disc clean.
- Move the system to a location away from vibration (for example, on top of a stable stand).
- Move the speakers away from the unit, or place them on separate stands. At high volume, speaker vibration may cause the sound to skip.

Play does not start from the first track.

- Press PLAY MODE repeatedly until both "PGM" and "SHUF" light off in the display to return to normal play.

Continued 

Starting playback takes more time than usual.

- The following MP3 discs take a longer time to start playback.
 - a disc recorded with a complicated tree structure.
 - a disc recorded in multisession mode.
 - a disc that has not been finalized (a disc to which data can be added).
 - a disc that has many folders.

USB device

You cannot start transferring to an USB device.

- The following problems may have occurred.
 - The USB device is full.
 - The number of audio files and folders on the USB device has reached the upper limit.
 - The USB device is write-protected.

Transferring is stopped before it is finished.

- You are using an unsupported USB device. See “Compatible USB devices with this system” (page 44) for the supported device types.
- The USB device is not formatted correctly. Refer to the USB device operation manual on how to format.
- Turn off the system and remove the USB device. If the USB device has a power switch, turn the USB device off and then on again after removing it from the system. Then perform transferring again.
- If the transferring and erase operations are repeated multiple times, the file structure within the USB device becomes complex. Refer to the USB device operation manual on how to deal with this problem.

Transferring to an USB device results in an error.

- You are using an unsupported USB device. See “Compatible USB devices with this system” (page 44) for the supported device types.
- The USB device was disconnected or the power was turned off during transferring. Delete the partially-transferred file, and transfer again. If this does not fix the problem, the USB device may be broken. Refer to the USB device operation manual on how to deal with this problem.
- Turn off the system and remove the USB device. If the USB device has a power switch, turn the USB device off and then on again after removing it from the system. Then perform transferring again.



Audio files or folders on the USB device cannot be erased.

- Check if the USB device is write-protected.
- The USB device was disconnected or the power was turned off during the erase operation. Delete the partially-erased file. If this does not fix the problem, the USB device may be broken. Refer to the USB device operation manual on how to deal with this problem.

Are you using a supported USB device?

- If you connect an unsupported USB device, the following problems may occur. See “Compatible USB devices with this system” (page 44) for the supported device types.
 - The USB device is not recognized.
 - File or folder names are not displayed on this system.
 - Playback is not possible.
 - The sound skips.
 - There is noise.
 - A distorted sound is output.
 - Transferring stops before it is finished.

“OVER CURRENT” appears.

- A problem has been detected with the level of electrical current from the  (USB) port. Turn off the system and remove the USB device from the  (USB) port. Make sure there is no problem with the USB device. If this display pattern persists, contact your nearest Sony dealer.

There is no sound.

- The USB device is not connected correctly. Turn off the system and reconnect the USB device, then turn on the system and check if “USB MEMORY” lights up in the display.

There is noise, skipping, or distorted sound.

- Turn off the system and reconnect the USB device, then turn on the system.
- The music data itself contains noise, or the sound is distorted. Noise may have entered during the transferring process. Delete the file, and try transferring again.

The USB device cannot be connected into the  (USB) port.

- The USB device is being connected backwards. Connect the USB device in the correct orientation.

“READING” is displayed for an extended time, or it takes a long time before playback starts.

- The reading process can take a long time in the following cases.
 - There are many folders or files on the USB device.
 - The file structure is extremely complex.
 - The memory capacity is excessive.
 - The internal memory is fragmented.
 Thus, we recommend following these guidelines.
 - Total folders on USB device: 100 or less
 - Total files per folder: 100 or less



Erroneous display.

- Send the audio files to the USB device again, as the audio files stored in the USB device may have been corrupted.
- The character codes that can be displayed by this system are numbers and alphabet only. Other characters are not displayed correctly.

The USB device is not recognized.

- Turn off the system and reconnect the USB device, then turn on the system.
- Connect the supported USB device (page 44).
- The USB device does not work properly. Refer to the USB device operation manual on how to deal with this problem.

Play does not start.

- Turn off the system and reconnect the USB device, then turn on the system.
- Connect the supported USB device (page 44).
- Press  (or  on the unit) to start play.

Play does not start from the first file.

- Set the play mode to normal play mode.

Audio file cannot be played back.

- MP3 files in MP3 PRO format cannot be played back.
- Some AAC files may not be played back correctly.
- WMA files in Windows Media Audio Lossless and Professional format cannot be played back.
- USB device formatted with file systems other than FAT16 or FAT32 (Cluster size 512 byte – 32 kbyte) are unsupported.*
- If you use partitioned USB device, only audio files on the first partition can be played.
- Playback is possible up to 8 levels.
- The number of folders has exceeded 997.

Continued 

- The number of files in a folder has exceeded 999.
- Files that are encrypted or protected by passwords, etc. cannot be played back.
- * This system supports FAT16 and FAT32, but some USB device may not support all of these FAT. For details, refer to the operation manual of each USB device or contact the manufacturer.

Tuner

Severe hum or noise, or stations cannot be received. (“TUNED” or “ST” flashes on the display.)

- Connect the antenna properly.
- Find a location and an orientation that provide good reception, and then set up the antenna again.
- Keep the antennas away from the speaker cords, the power cord and the USB cable to avoid picking up noise.
- Connect a commercially available external antenna.
- Consult your nearest Sony dealer if the supplied AM antenna has come off the plastic stand.
- Turn off nearby electrical equipment.

Tape deck

The sound exhibits excessive wow or flutter or dropout.

- Clean the capstans and pinch rollers. Also, clean and demagnetize the tape heads. See “Precautions” for details (page 38).

Meter

Meter pointer does not move.

- “MTR POINTER” is set to “OFF” in the OPTIONS menu. Select other settings.
- Meter mode is set to “METER OFF”. Press METER MODE on the unit repeatedly to select other modes.
- The headphones are connected to the PHONES jack. Disconnect the headphones.

Meter display is turned off.

- “MTR POINTER” and “M-BACKLIGHT” are set to “OFF” in the OPTIONS menu. Select other settings.
- Meter mode is set to “METER OFF”. Press METER MODE on the unit repeatedly to select other modes.

Meter display is flashing.

- “MTR POINTER” and “M-BACKLIGHT” are set to “FLASH” in the OPTIONS menu. Select other settings.
- Meter mode is set to “EXCITE 1” or “EXCITE 2”. Press METER MODE on the unit repeatedly to select other modes.

To change the AM tuning interval (except for European and Russian models)

The AM tuning interval is factory-preset to 9 kHz (or 10 kHz, for some areas). You cannot change the AM tuning interval in Power Saving Mode.

Use the buttons on the unit for this operation.

- 1 Select the AM band, and then turn off the system.
- 2 While holding down ENTER, press I/⏻.

The system turns on automatically and “AM 9K STEP” or “AM 10K STEP” appears.

All the AM preset stations are erased. To reset the interval to the factory preset, repeat the procedure.

To reset the system to factory settings

If the system still does not operate properly, reset the system to factory settings. You cannot reset the system to factory settings in Power Saving Mode. Use the buttons on the unit for this operation.

- 1 Disconnect and reconnect the power cord, and then turn on the system.
- 2 Press ■, ENTER, and I/⏻ at the same time.
“COLD RESET” appears in the display.
All user-configured settings, such as preset radio stations, timer, and the clock, are reset to factory setting.

Messages

CD/MP3 player, Tuner, Tape

LOCKED: The disc tray does not open. Contact your nearest Sony dealer.

NO DISC: There is no disc on the disc tray.

NO STEP: All of the programmed steps have been erased.

NOT IN USE: You pressed an invalid button.

OFF TIME NG: The Play Timer or Recording Timer start and stop times are set to the same time.

OVER: You have reached the end of the disc while pressing ►► during playback or pause.

PUSH SELECT: You tried to set the clock or timer during timer operation.

PUSH STOP: Stop playback, then select the play mode.

READING: The system is reading information of the disc. Some buttons are not available.

SET CLOCK: You pressed CLOCK/TIMER SELECT (RM-AMU006) before the clock is set.

SET TIMER: You pressed CLOCK/TIMER SELECT (RM-AMU006) before the Play Timer or Recording Timer is set.

STEP FULL: You tried to program more than 25 steps.

USB device

DATA ERROR: You tried to play a file that is not playable.

DEVICE ERROR: The USB device could not be recognized or an unknown device is connected (page 34).

Continued ⇨

DEVICE FULL: The memory of the USB device is full.

FATAL ERROR: The USB device was removed during transferring or erase operation, and may have been damaged.

FOLDER FULL: You cannot transfer onto the USB device because the number of folders have reached its maximum.

NO STEP: All of the programmed steps have been erased.

NO TRACK: No playable file is loaded in the system.

NOT IN USE: You tried to perform a specific operation under conditions where that operation is prohibited.

NOT SUPPORTED: An unsupported USB device is connected, or the USB device is connected to this system through a hub.

OVER CURRENT: An over current was detected.

PROTECTED: The USB device is write-protected.

PUSH STOP: You tried to perform an operation that can be performed only when the system is stopped.

REC ERROR: Transferring did not start, stopped partway, or otherwise could not be performed (page 34).

REMOVED: The USB device has been removed.

STEP FULL: You tried to program more than 25 steps.

TRACK FULL: You cannot transfer onto the USB device because the number of files have reached its maximum.

USB READING: The system is reading information of the USB device. Some buttons are not available.

Precautions

Discs that this system CAN play

- AUDIO CD
- CD-R/CD-RW (audio data/MP3 files)

Discs that this system CANNOT play

- CD-ROM
- CD-R/CD-RW other than those recorded in AUDIO CD format or MP3 format conforming to ISO 9660 Level 1/Level 2, Joliet in the expansion format
- CD-R/CD-RW recorded in multisession that have not ended by “closing the session”
- CD-R/CD-RW of poor recording quality, CD-R/CD-RW that have scratches or are dirty, or CD-R/CD-RW recorded with an incompatible recording device
- CD-R/CD-RW which is finalized incorrectly
- Discs containing files other than MPEG 1 Audio Layer-3 (MP3) files
- Discs of non-standard shape (for example, heart, square, star)
- Discs that have adhesive tape, paper, or sticker attached to them
- Rental or used discs with attached seals where the glue extends beyond the seal
- Discs that have labels printed using ink that feels tacky when touched

Notes on discs

- Before playing, wipe the disc with a cleaning cloth from the center out to the edge.
- Do not clean discs with solvents, such as benzene thinner, or commercially available cleaners or anti-static spray intended for vinyl LPs.
- Do not expose discs to direct sunlight or heat sources such as hot air ducts, nor leave it in a car parked in direct sunlight.

On safety

- The unit is not disconnected from the mains as long as it is connected to the AC outlet, even if the unit itself has been turned off.
- Completely disconnect the power cord (mains lead) from the wall socket (mains) if it is not going to be used for an extended period of time. When unplugging the unit, always grip the plug. Never pull the cord itself.
- Should any solid object or liquid get into the system, unplug the system, and have it checked by qualified personnel before operating it again.
- AC power cord must be changed only at the qualified service shop.

On placement

- Do not place the system in an inclined position or in locations that are extremely hot, cold, dusty, dirty, or humid or lacking adequate ventilation, or subject to vibration, direct sunlight or a bright light.
- Be careful when placing the unit or speakers on surfaces that have been specially treated (for example, with wax, oil, polish) as staining or discoloration of the surface may result.
- If the system is brought directly from a cold to a warm location or is placed in a very damp room, moisture may condense on the lens inside the unit, and cause the system to malfunction. In this situation, remove the disc, and leave the system turned on for about an hour until the moisture evaporates.

On heat buildup

- Heat buildup on the unit during operation is normal and is not a cause for alarm.
- Do not touch the cabinet if it has been used continuously at a high volume because the cabinet may have become hot.
- Do not obstruct the ventilation holes.

On the speaker system

This speaker system is not magnetically shielded, and the picture on nearby TV sets may become magnetically distorted. In this situation, turn off the TV, wait 15 to 30 minutes, and turn it back on. If there is no improvement, move the speakers far away from the TV.

Cleaning the cabinet

Clean this system with a soft cloth slightly moistened with a mild detergent solution. Do not use any type of abrasive pad, scouring powder, or solvent, such as thinner, benzene, or alcohol.

To prevent a tape from being accidentally recorded over

Break off the tape's overwrite protection tab from side A or B as illustrated.

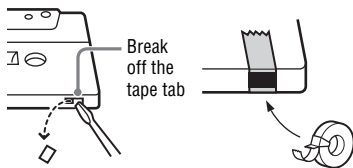

To later reuse the tape for recording, cover the broken tab with adhesive tape.

About a tape longer than 90 minutes

The use of the tape with more than 90 minutes of play time is not recommended except for long, continuous recording or playback.

Cleaning the tape heads

Use a dry- or wet-type cleaning tape (available separately) after every 10 hours of use, before you start an important recording, or after playing an old tape. Failure to clean the tape heads can cause degraded sound quality or an inability of the unit to record or play tapes. For details, refer to the instructions of the cleaning tape.

Demagnetizing the tape heads

Use a demagnetizing tape (available separately) after every 20 to 30 hours of use. Failure to demagnetize the tape heads can cause an increase in noise, a loss of high frequency sound, and an inability to completely erase tapes. For details, refer to the instructions of the demagnetizing tape.

Specifications

AUDIO POWER SPECIFICATION

POWER OUTPUT AND TOTAL HARMONIC DISTORTION:
(LBT-ZT4 only)

With 6 ohm loads, both channels driven, from 120 Hz – 10 kHz; rated 110 watts per channel minimum RMS power, with no more than 0.7% total harmonic distortion from 250 miliwatts to rated output.

Amplifier section

MHC-GT555

Brazilian model only

The following are measured at AC 127 or 220 V 50/60 Hz

Front speaker

RMS output power (reference):
150 W + 150 W (at 6 Ω , 1 kHz,
10% THD)

Subwoofer

RMS output power (reference): 190 W
(at 6 Ω , 100 Hz, 10% THD)

Other models

The following are measured at AC 120, 127, 220, 230 – 240 V 50/60 Hz

Front speaker

Power output (rated): 110 W + 110 W
(at 6 Ω , 1 kHz, 1% THD)
RMS output power (reference):
200W + 200 W (per channel at 6 Ω ,
1 kHz, 10% THD)

Subwoofer

RMS output power (reference): 190 W
(at 6 Ω , 100 Hz, 10% THD)

MHC-GT444

Brazilian model only

The following are measured at AC 127 or 220 V 50/60 Hz

Front speaker

RMS output power (reference):
125 W + 125 W (at 6 Ω , 1 kHz,
10% THD)

Subwoofer

RMS output power (reference): 150 W
(at 6 Ω , 100 Hz, 10% THD)

Other models

The following are measured at AC 120, 127, 220, 230 – 240 V 50/60 Hz

Front speaker

Power output (rated): 90 W + 90 W
(at 6 Ω , 1 kHz, 1% THD)
RMS output power (reference):
150 W + 150 W (per channel at 6 Ω ,
1 kHz, 10% THD)

Subwoofer

RMS output power (reference): 150 W
(at 6 Ω , 100 Hz, 10% THD)

MHC-GT222

Brazilian model only

The following are measured at AC 127 or 220 V 50/60 Hz

RMS output power (reference):
150 W + 150 W (at 6 Ω , 1 kHz,
10% THD)

Other model

The following are measured at AC 120, 127, 220, 230 – 240V 50/60 Hz

Power output (rated): 110 W + 110 W
(at 6 Ω , 1 kHz, 1% THD)
RMS output power (reference):
200 W + 200 W (per channel at 6 Ω ,
1 kHz, 10% THD)

MHC-GT111**Brazilian model only**

The following are measured at AC 127 or 220 V 50/60 Hz

RMS output power (reference):
100 W + 100 W (at 6 Ω , 1 kHz,
10% THD)

Other models

The following are measured at AC 120, 127, 220, 230 – 240V 50/60 Hz

Power output (rated): 60 W + 60 W
(at 6 Ω , 1 kHz, 1% THD)

RMS output power (reference):
100 W + 100 W (per channel at 6 Ω ,
1 kHz, 10% THD)

LBT-ZT4

The following are measured at AC 120 V 60 Hz

Front speaker

RMS output power (reference):
180 W + 180 W (per channel at 6 Ω ,
1 kHz, 10% THD)

Subwoofer

RMS output power (reference): 180 W
(at 6 Ω , 100 Hz, 10% THD)

Inputs

AUDIO INPUT (LBT-ZT4 only): sensitivity
800 mV, impedance 47 kilohms

AUDIO INPUT L/R (other models): voltage
250 mV, impedance 47 kilohms

MIC: sensitivity 1 mV, impedance
10 kilohms

↔ (USB) port: Type A

DMPORT (LBT-ZT4 only)

Outputs

PHONES: accepts headphones of 8 Ω or
more

FRONT SPEAKER: accepts impedance of
6 Ω

SUBWOOFER (MHC-GT555/
MHC-GT444/LBT-ZT4 only): accepts
impedance of 6 Ω

USB section

Supported bit rate

MP3 (MPEG 1 Audio Layer-3):
32 – 320 kbps, VBR
WMA: 32 – 192 kbps, VBR
AAC: 48 – 320 kbps

Sampling frequencies

MP3 (MPEG 1 Audio Layer-3):
32/44.1/48 kHz
WMA: 44.1 kHz
AAC: 44.1 kHz

Transfer speed

Full-Speed

Supported USB device

Mass Storage Class

Maximum current

500 mA

CD player section

System: Compact disc and digital audio
system

Laser Diode Properties

Emission Duration: Continuous

Laser Output*: Less than 44.6 μ W

* This output is the value measurement
at a distance of 200 mm from the
objective lens surface on the Optical
Pick-up Block with 7 mm aperture.

Frequency response: 20 Hz – 20 kHz

Signal-to-noise ratio: More than 90 dB

Dynamic range: More than 88 dB

Tape deck section

Recording system: 4-track 2-channel, stereo

Tuner section

FM stereo, FM/AM superheterodyne tuner

FM tuner section

Tuning range:

North American and Brazilian models:
87.5 – 108.0 MHz (100 kHz step)
Other models:

87.5 – 108.0 MHz (50 kHz step)

Antenna: FM lead antenna

Antenna terminals: 75 ohms unbalanced

Intermediate frequency: 10.7 MHz

Continued 

AM tuner section

Tuning range

Pan American and Oceanian models:

530 – 1,710 kHz (with 10 kHz tuning interval)

531 – 1,710 kHz (with 9 kHz tuning interval)

European and Russian models:

531 – 1,602 kHz (with 9 kHz tuning interval)

Other models:

530 – 1,610 kHz (with 10 kHz tuning interval)

531 – 1,602 kHz (with 9 kHz tuning interval)

Antenna: AM loop antenna, external antenna terminal

Intermediate frequency: 450 kHz

Speakers

MHC-GT555

- Front speaker (SS-GT555M)
 - Speaker system: 3-way, 3-unit, bass reflex
 - Speaker unit:
 - Subwoofer: 150 mm, cone type
 - Woofers: 150 mm, cone type
 - Tweeter: 40 mm, horn type
 - Rated impedance: 6 ohms
 - Dimensions (w/h/d) (Approx.): 250 × 391 × 282 mm
 - Mass (Approx.): 5.1 kg per speaker
- Subwoofer (SS-WG555M)
 - Speaker system: 1-unit, bass reflex
 - Speaker unit:
 - Woofers: 250 mm, cone type
 - Rated impedance: 6 ohms
 - Dimensions (w/h/d) (Approx.): 319 × 391 × 326 mm
 - Mass (Approx.): 7.8 kg

MHC-GT444

- Front speaker (European model except United Kingdom and Russian only) (SS-GT444M)
 - Front speaker (Other models) (SS-GT444)
 - Speaker system: 3-way, 3-unit, bass reflex
 - Speaker unit:
 - Subwoofer: 130 mm, cone type
 - Woofers: 130 mm, cone type
 - Tweeter: 40 mm, horn type
 - Rated impedance: 6 ohms
 - Dimensions (w/h/d) (Approx.): 238 × 361 × 238 mm
 - Mass (Approx.): 3.9 kg per speaker
- Subwoofer (European model except United Kingdom and Russian only) (SS-WG444M)
 - Subwoofer (Other models) (SS-WG444)
 - Speaker system: 1-unit, bass reflex
 - Speaker unit:
 - Woofers: 200 mm, cone type
 - Rated impedance: 6 ohms
 - Dimensions (w/h/d) (Approx.): 266 × 361 × 320 mm
 - Mass (Approx.): 6.3 kg

MHC-GT222

- Front speaker (European model only) (SS-GT444M)
 - Front speaker (Other models) (SS-GT444)
 - Speaker system: 3-way, 3-unit, bass reflex
 - Speaker unit:
 - Subwoofer: 130 mm, cone type
 - Woofers: 130 mm, cone type
 - Tweeter: 40 mm, horn type
 - Rated impedance: 6 ohms
 - Dimensions (w/h/d) (Approx.): 238 × 361 × 238 mm
 - Mass (Approx.): 3.9 kg per speaker

MHC-GT111

- Front speaker (European model only) (SS-GT111M)

Front speaker (Asian model only) (SS-GT111S)

Front speaker (Other models) (SS-GT111)

Speaker system: 2-way, 2-unit, bass reflex

Speaker unit:

Woofers: 160 mm, cone type

Tweeter: 40 mm, horn type

Rated impedance: 6 ohms

Dimensions (w/h/d) (Approx.):

216 × 361 × 208 mm

Mass (Approx.): 2.7 kg per speaker

LBT-ZT4

- Front speaker (SS-ZT4)

Speaker system: 3-way, 3-unit, bass reflex

Speaker unit:

Subwoofer: 5 inch (130 mm), cone type

Woofers: 5 inch (130 mm), cone type

Tweeter: 1 1/2 inch (40 mm), horn type

Rated impedance: 6 ohms

Dimensions (w/h/d) (Approx.):

9 3/8 × 14 1/4 × 9 3/8 inch (238 × 361 × 238 mm)

Mass (Approx.): 8 lb 10 oz (3.9 kg) per speaker

- Subwoofer (SS-WG4)

Speaker system: 1-unit, bass reflex

Speaker unit:

Woofers: 8 inch (200 mm), cone type

Rated impedance: 6 ohms

Dimensions (w/h/d) (Approx.):

10 1/2 × 14 1/4 × 12 5/8 inch (266 × 361 × 320 mm)

Mass (Approx.): 13 lb 15 oz (6.3 kg)

General**Power requirements**

North American model: AC 120 V, 60 Hz

European and Russian models: AC 230 V, 50/60 Hz

Oceanian model: AC 230 – 240 V, 50/60 Hz

Mexican model: AC 127 V, 60 Hz

Argentine model: AC 220 V, 50/60 Hz

Other models: AC 120, 220 or 230 – 240 V, 50/60 Hz, Adjustable with voltage selector

Power consumption

MHC-GT555: 216 W

MHC-GT444: 286 W

MHC-GT222: 163 W

MHC-GT111 (Brazilian model): 185 W

MHC-GT111 (Other models): 150 W

LBT-ZT4 (American model): 225 W

LBT-ZT4 (Canadian model): 285 VA

Dimensions (w/h/d) (excl. speakers)

Approx. 231 × 361 × 437.5 mm

(9 1/8 × 14 1/4 × 17 1/4 inch)

Mass (excl. speakers)

HCD-GT555/GT444/GT222,

HCD-ZT4: 10.0 kg (22 lb 1 oz)

HCD-GT222 (European model): 9.6 kg

HCD-GT111: 8.0 kg

Supplied accessories:

Remote Commander (1), R6 (Size AA) batteries (2), AM loop antenna (1), FM lead antenna (1), Speaker pads MHC-GT555/MHC-GT444/LBT-ZT4 (12), MHC-GT222/MHC-GT111 (8), TDM-iP10 (M) (LBT-ZT4 only) (1)

Design and specifications are subject to change without notice.



- Standby power consumption: 0.5 W
- Halogenated flame retardants are not used in the certain printed wiring boards.

Compatible USB devices with this system

You can use the following Sony USB devices and Sony Ericsson mobile phone on this system.

Verified Sony USB device (as of March 2008)

Product name	Model name
Walkman®	NWD-B103 / B103F / B105 / B105F
	NWZ-A815 / A816 / A818
	NWZ-S515 / S516 / S615F / S616F / S618F
iC Recorder	ICD-SX57 / SX67 / SX77
	ICD-U50 / U60 / U70
	ICD-SX68 / SX78 / SX88
MICROVAULT	USM512JX / 1GJX / 2GJX / 4GJX

Verified Sony Ericsson mobile phone (as of March 2008)

Product name	Model name
Walkman® phone	W880i / W850i / W710i / W660i / W580i / W910i

Check the websites below for the latest information about compatible devices.

<U.S.A.>

<http://www.sony.com/shelfsupport>

<Canada>

(English)

<http://www.sony.ca/ElectronicsSupport/>

(French)

<http://fr.sony.ca/ElectronicsSupport/>

<Europe>

<http://sonydigital-link.com/dna>

<Latin America>

<http://www.sony-latin.com/pa/info>

<Asia and Oceania>

<http://www.css.ap.sony.com/>

Notes

- Do not use USB devices other than these USB devices. Operation of models not listed here is not guaranteed.
- Operation may not always be ensured even when using these USB devices.
- Some of these USB devices may not be available for purchase in certain areas.
- When formatting USB device, be sure to format using the device itself or the dedicated formatting software for that device. Otherwise, you may be unable to transfer the USB device properly on this system.

Notes on using the Sony Ericsson mobile phone

- When connecting to this system, set the data transfer mode of your mobile phone to File Transfer (Mass Storage). For details, refer to the operation manual supplied with the mobile phone.
- Use the USB cable supplied with the mobile phone when connecting to the system.
- Some audio files supported by the mobile phone are not supported by this system.
- In the case that the song which is registered as the playlist in the mobile phone is erased by this system, the playlist registration is not deleted.

Notes on Walkman®

- Some audio files supported by the Sony digital music player are not supported by this system.
- When the Sony digital music player is connected to this system, wait until the display of “Creating Library” or “Creating Database” disappears.
- When transferring music data from the Sony digital music player by using “Media Manager for WALKMAN”, transfer in MP3 format.
- MP4 format file (AAC or VIDEO) cannot be displayed by this system.



* 3 2 8 7 3 7 9 3 1 * (2)