



## GaAs pHEMT MMIC 1/2 WATT POWER AMPLIFIER, 22 - 26.5 GHz

### Typical Applications

The HMC863LP4E is ideal for:

- Point-to-Point Radios
- Point-to-Multi-Point Radios
- VSAT
- Military & Space

### Features

- Saturated Output Power:  
up to +27.5 dBm @ 15% PAE
- High Output IP3: +33 dBm
- High Gain: 21.5 dB
- DC Supply: +6V @ 350mA
- No External Matching Required
- 24 Lead 4x4 mm SMT Package: 16 mm<sup>2</sup>

### Functional Diagram

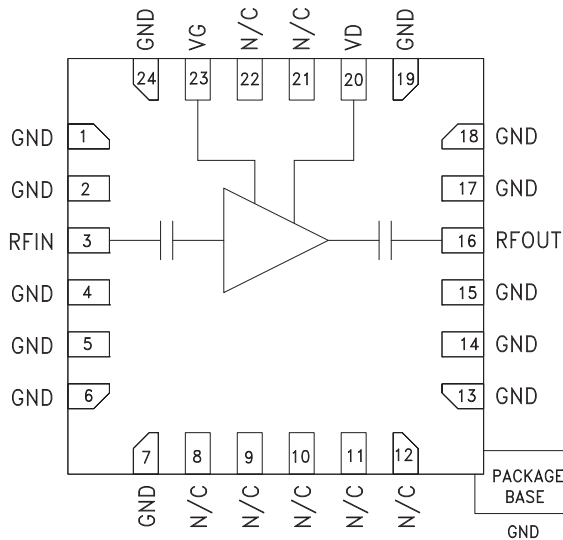

### General Description

The HMC863LP4E is a three stage GaAs pHEMT MMIC 1/2 Watt Power Amplifier which operates between 22 and 26.5 GHz. The HMC863LP4E provides 21.5 dB of gain, +27.5 dBm of saturated output power and 15% PAE from a +6V supply. High output IP3 makes the HMC863LP4E ideal for point-to-point and point-to-multi-point radio systems as well as VSAT applications. The RF I/Os are DC blocked and matched to 50 Ohms for ease of integration into higher level assemblies. The HMC863LP4E can also be operated from a 5V supply with only a slight decrease in output power & IP3.

### Electrical Specifications, $T_A = +25^\circ C$ , $V_{dd} = V_{dd1} = V_{dd2} = +6V$ , $I_{dd} = 350mA$ [1]

Parameter	Min.	Typ.	Max.	Units
Frequency Range	22 - 26.5			GHz
Gain	19	21.5		dB
Gain Variation Over Temperature		0.032		dB/ °C
Input Return Loss		11		dB
Output Return Loss		15		dB
Output Power for 1 dB Compression (P1dB)	22	24.5		dBm
Saturated Output Power (P <sub>sat</sub> )		27		dBm
Output Third Order Intercept (IP3) <sup>[2]</sup>		33		dBm
Total Supply Current (I <sub>dd</sub> )		350	380	mA

[1] Adjust V<sub>gg</sub> between -2 to 0V to achieve I<sub>dd</sub> = 350mA typical.

[2] Measurement taken at +6V @ 350mA, P<sub>out</sub> / Tone = +14 dBm



## GaAs pHEMT MMIC 1/2 WATT POWER AMPLIFIER, 22 - 26.5 GHz

**Broadband Gain &  
Return Loss vs. Frequency**

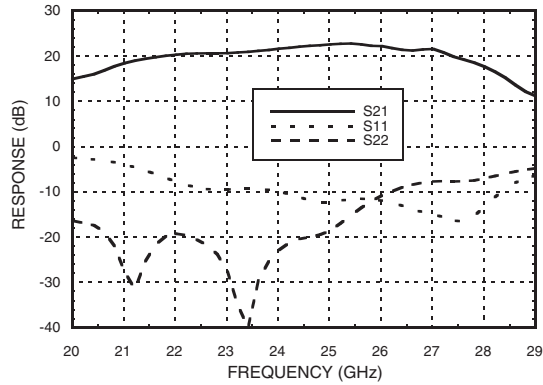

**Gain vs. Temperature**

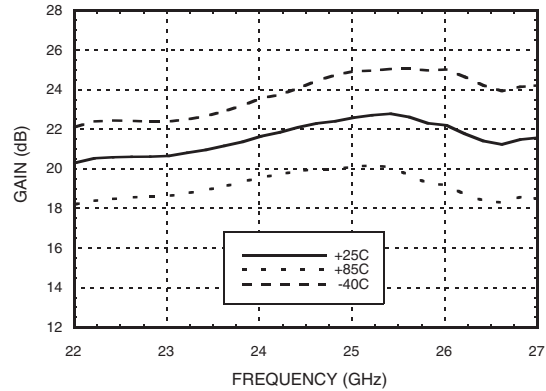

**Input Return Loss vs. Temperature**

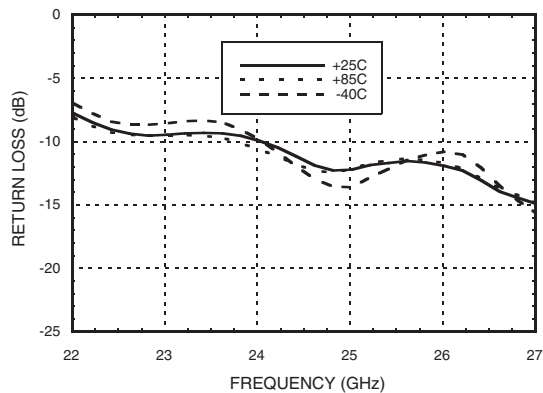

**Output Return Loss vs. Temperature**

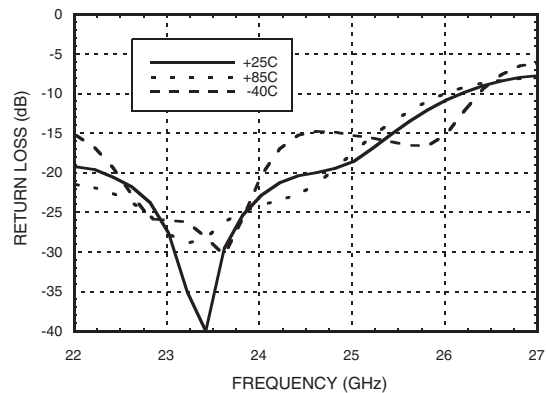

**P1dB vs. Temperature**

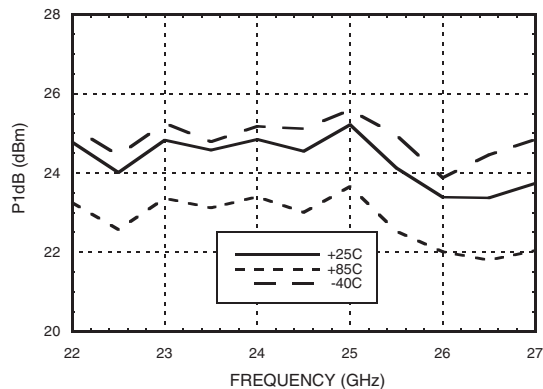

**P1dB vs. Supply Voltage**

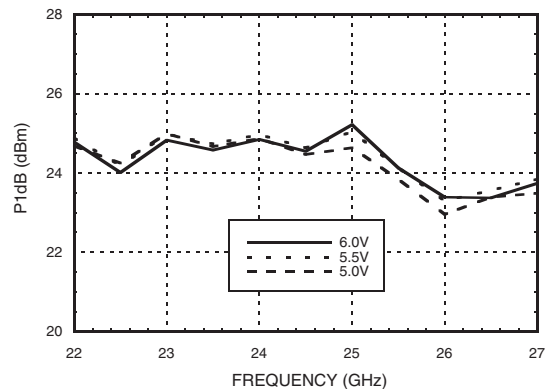



## GaAs pHEMT MMIC 1/2 WATT POWER AMPLIFIER, 22 - 26.5 GHz

**Psat vs. Temperature**

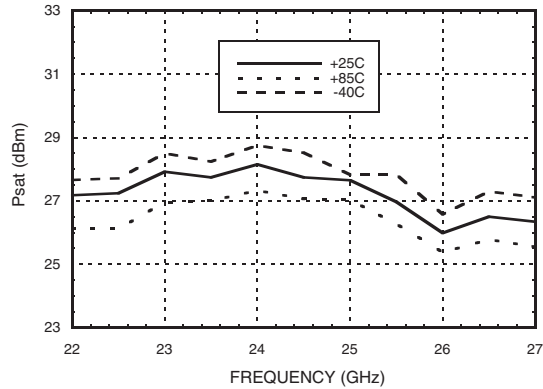

**Psat vs. Supply Voltage**

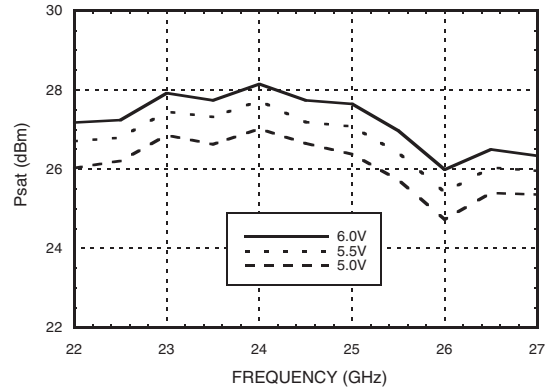

**P1dB vs. Supply Current (Idd)**

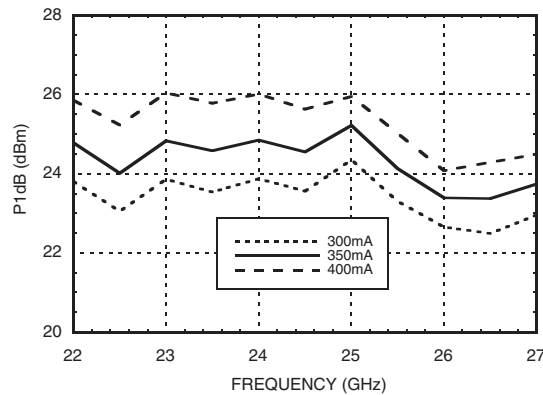

**Psat vs. Supply Current (Idd)**

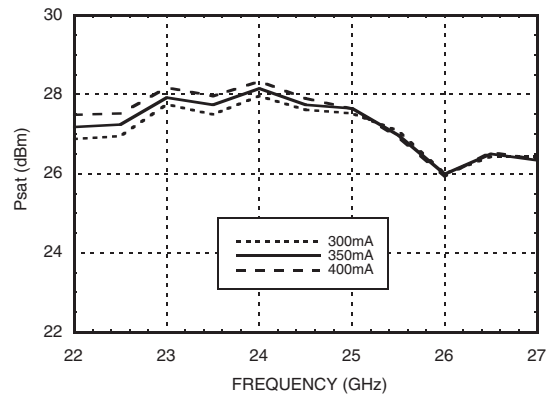

**Output IP3 vs. Temperature, Pout/Tone = +14 dBm**

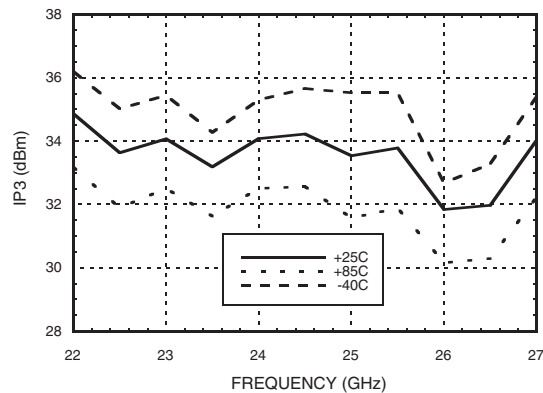

**Output IP3 vs. Supply Current, Pout/Tone = +14 dBm**

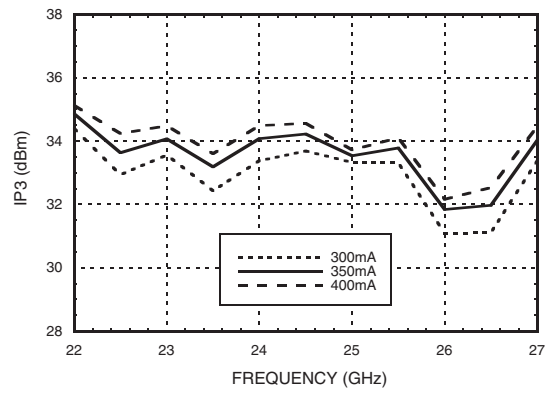



## GaAs pHEMT MMIC 1/2 WATT POWER AMPLIFIER, 22 - 26.5 GHz

**Output IP3 vs.  
Supply Voltage, Pout/Tone = +14 dBm**

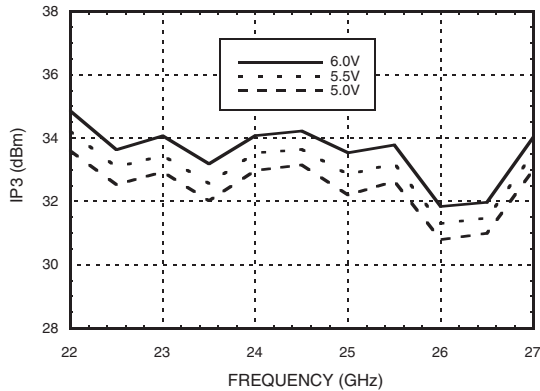

**Output IM3 @ Vdd = +5V**

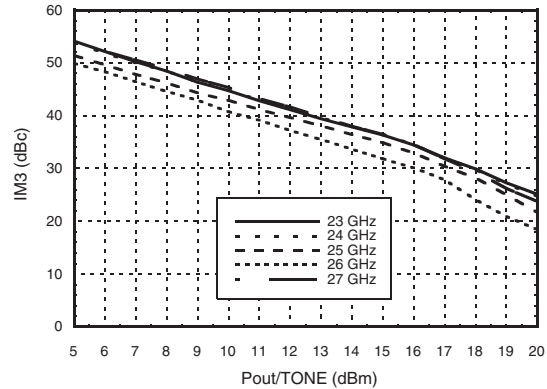

**Output IM3 @ Vdd = +5.5V**

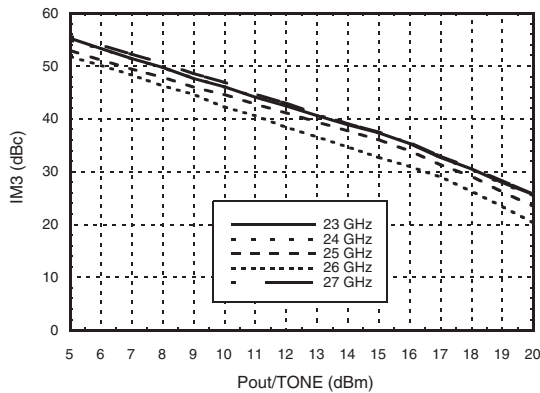

**Output IM3 @ Vdd = +6V**

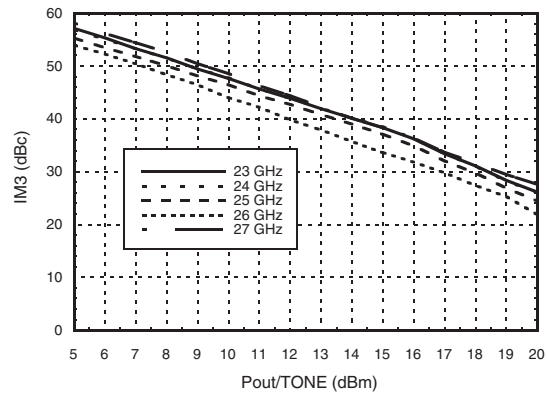

**Power Compression @ 25 GHz**

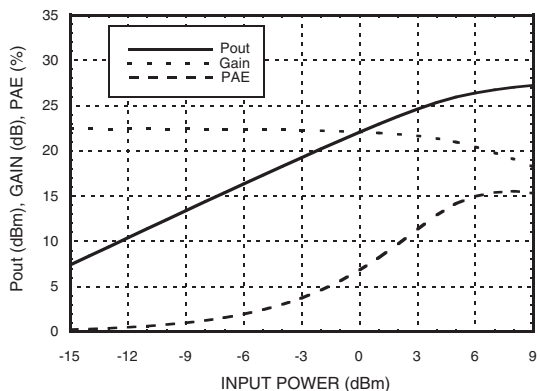

**Reverse Isolation vs. Temperature**

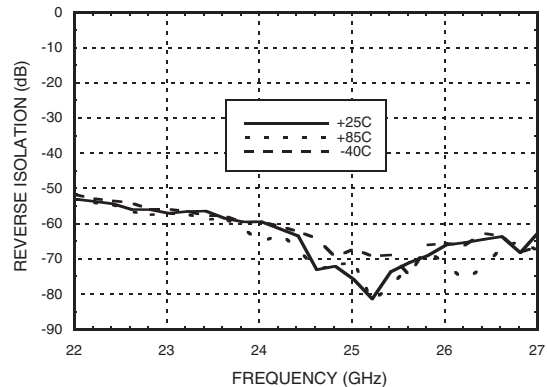

## GaAs pHEMT MMIC 1/2 WATT POWER AMPLIFIER, 22 - 26.5 GHz



**Gain & Power vs.  
Supply Current @ 25 GHz**

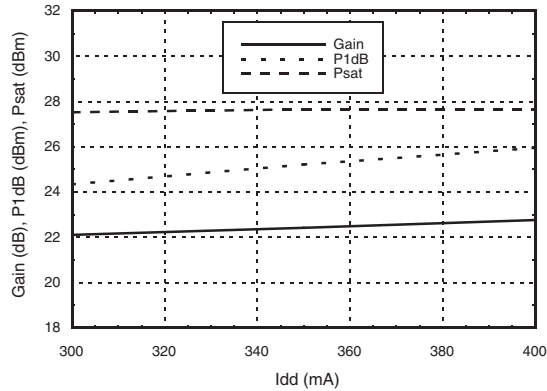

**Gain & Power vs.  
Supply Voltage @ 25 GHz**

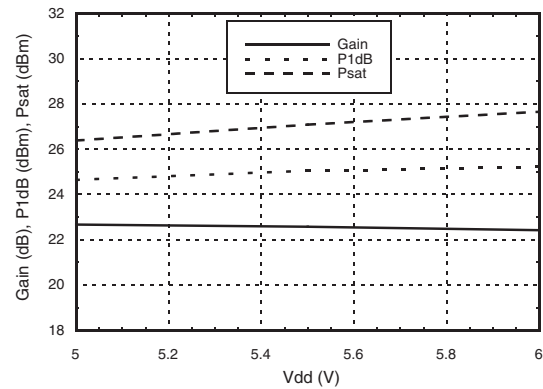

**Power Dissipation**

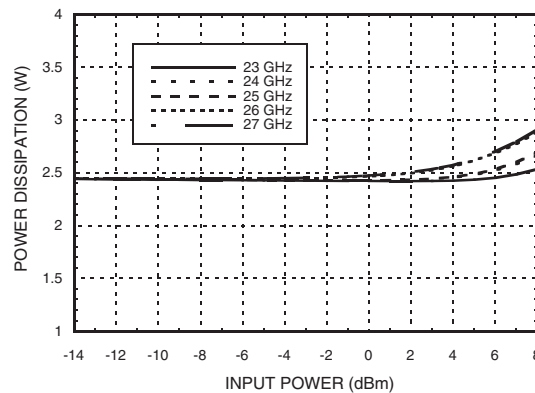

### Absolute Maximum Ratings

Drain Bias Voltage (Vd)	6.3V
RF Input Power (RFIN)	+26 dBm
Channel Temperature	150 °C
Continuous Pdiss (T= 85 °C) (derate 37 mW/°C above 85 °C)	2.52 W
Thermal Resistance (channel to ground paddle)	26.9 C/W
Storage Temperature	-65 to +150 °C
Operating Temperature	-55 to +85 °C
ESD Sensitivity (HBM)	Class 0, 150V

### Typical Supply Current vs. Vdd

Vdd (V)	Idd (mA)
+5.0	350
+5.5	350
+6.0	350

Note: Amplifier will operate over full voltage ranges shown above Vgg adjusted to achieve Idd = 350mA at +5.5V



**ELECTROSTATIC SENSITIVE DEVICE  
OBSERVE HANDLING PRECAUTIONS**

## GaAs pHEMT MMIC 1/2 WATT POWER AMPLIFIER, 22 - 26.5 GHz

### Outline Drawing

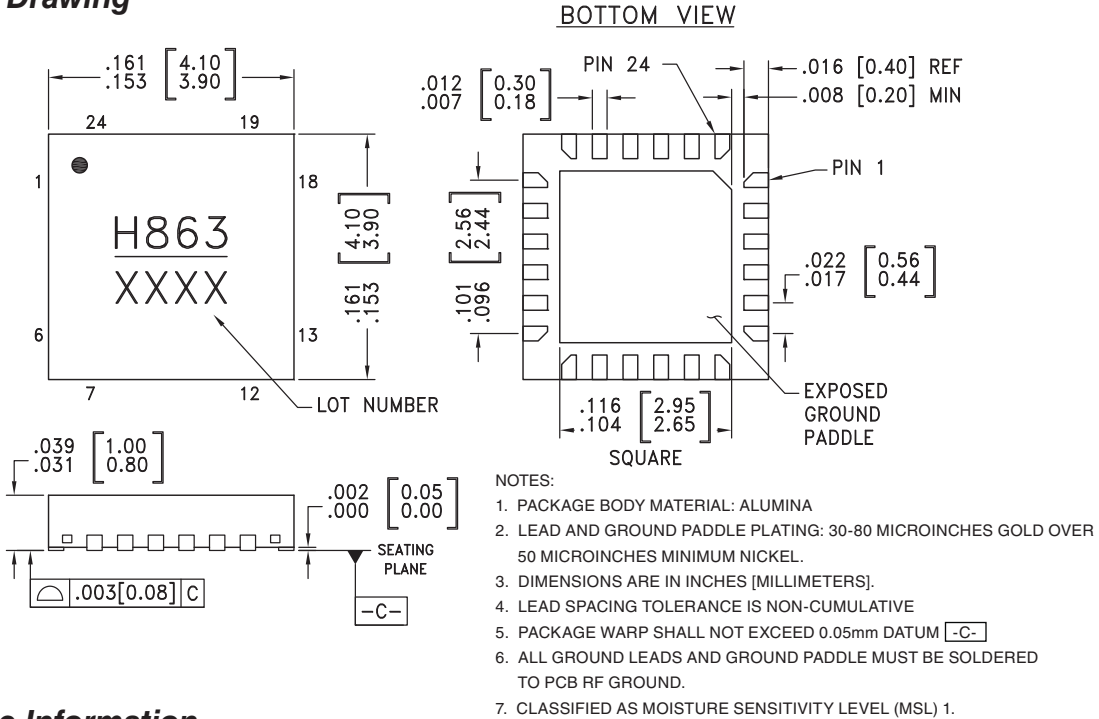

### Package Information

Part Number	Package Body Material	Lead Finish	MSL Rating	Package Marking <sup>[1]</sup>
HMC863LP4E	RoHS-compliant Low Stress Injection Molded Plastic	100% matte Sn	MSL1 <sup>[2]</sup>	H863 XXXX

[1] 4-Digit lot number XXXX

[2] Max peak reflow temperature of 260 °C

### Pin Descriptions

Pin Number	Function	Description	Interface Schematic
1, 2, 4 - 7, 12 - 15, 17 - 19, 24 Package Bottom	GND	Ground pins and package bottom must be connected to RF/DC ground.	
3	RFIN	This pin is AC coupled and matched to 50 Ohms.	
8 - 11	N/C	The pins are not connected internally; however, all data shown herein was measured with these pins connected to RF/DC ground externally.	
16	RFOUT	This pin is AC coupled and matched to 50 Ohms.	
20	Vd	Drain bias for amplifier. External 100 pF, 0.1 μF and 4.7 μF bypass capacitors are required.	
23	Vg	Gate control for PA. Adjust Vg to achieve recommended bias current. External 100 pF, 0.1 μF and 4.7 μF bypass capacitors are required.	

### Evaluation PCB

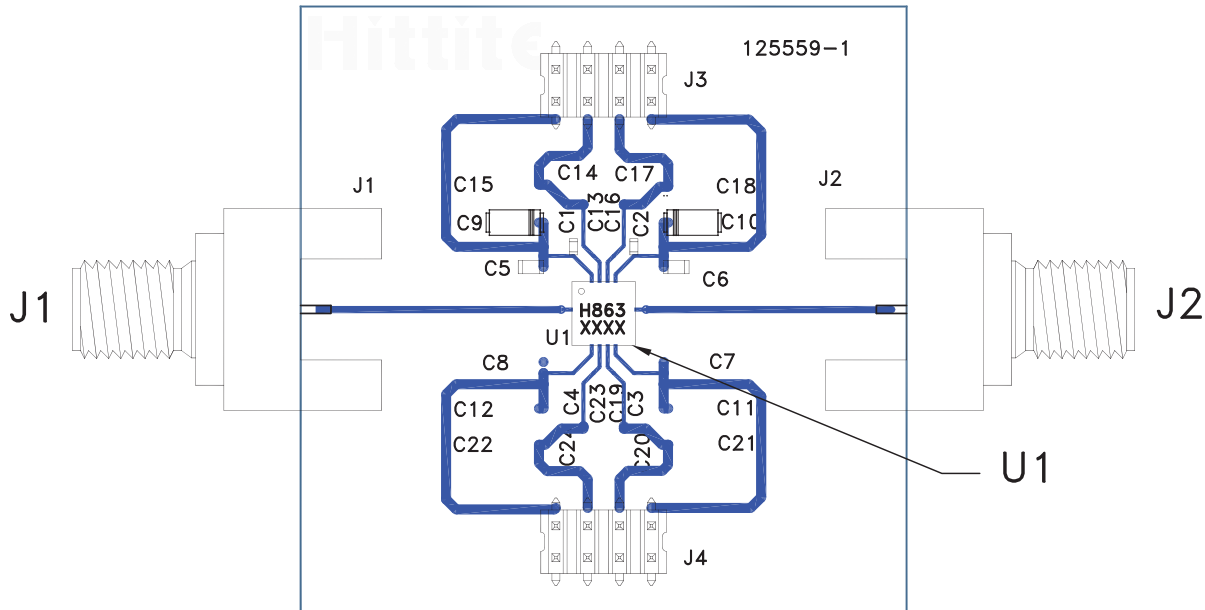

### List of Materials for Evaluation PCB 130560 [1]

Item	Description
J1 - J2	2.9 mm Connectors
J3 - J4	DC Pins
C1, C2	100 pF Capacitors, 0402 Pkg.
C6	10 kpF Capacitor, 0402 Pkg
C10	4.7 μF Capacitor, 0402 Pkg.
U1	HMC863LP4E Power Amplifier
PCB [2]	125559 Evaluation PCB

[1] Reference this number when ordering complete evaluation PCB

[2] Circuit Board Material: Rogers 4350 or Arlon FR4

The circuit board used in the application should use RF circuit design techniques. Signal lines should have 50 Ohm impedance while the package ground leads and exposed paddle should be connected directly to the ground plane similar to that shown. A sufficient number of via holes should be used to connect the top and bottom ground planes. The evaluation board should be mounted to an appropriate heat sink. The evaluation circuit board shown is available from Hittite upon request.

**Application Circuit**
