

RoHS Compliant Product

A suffix of "-C" specifies halogen & lead-free

**FEATURES**

- Fast Switching Speed
- Surface Mount Package Ideally Suited for Automatic Insertion
- For General Purpose Switching Applications
- High Conductance

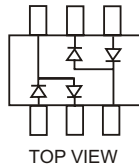
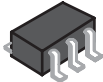

SOT-363

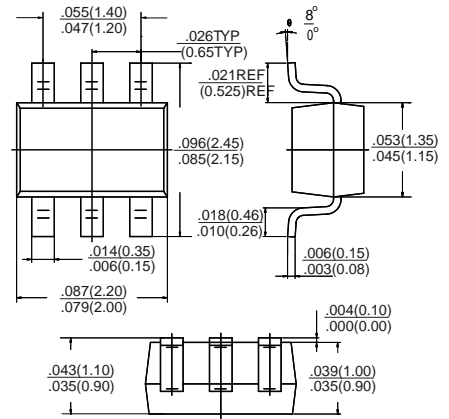

**MAXIMUM RATINGS (EACH DIODE)**

Rating	Symbol	Value	Unit
Reverse Voltage	$V_R$	75	Vdc
Forward Current	$I_F$	150	mAdc
Peak Forward Surge Current	$I_{FM}(\text{surge})$	400	mAdc

**THERMAL CHARACTERISTICS**

Characteristic	Symbol	Max	Unit
Total Device Dissipation FR-5 Board <sup>(1)</sup> $T_A = 25^\circ\text{C}$ Derate above $25^\circ\text{C}$	$P_D$	200	mW
		1.8	mW/ $^\circ\text{C}$
Thermal Resistance, Junction to Ambient	$R_{\theta JA}$	556	$^\circ\text{C}/\text{W}$
Total Device Dissipation Alumina Substrate, <sup>(2)</sup> $T_A = 25^\circ\text{C}$ Derate above $25^\circ\text{C}$	$P_D$	250	mW
		2.4	mW/ $^\circ\text{C}$
Thermal Resistance, Junction to Ambient	$R_{\theta JA}$	417	$^\circ\text{C}/\text{W}$
Junction and Storage Temperature	$T_J, T_{stg}$	-55 to +150	$^\circ\text{C}$

**DEVICE MARKING**

BAV99DW= KJG

**ELECTRICAL CHARACTERISTICS ( $T_A = 25^\circ\text{C}$  unless otherwise noted) (EACH DIODE)**

Characteristic	Symbol	Min	Max	Unit
----------------	--------	-----	-----	------

**OFF CHARACTERISTICS**

Reverse Breakdown Voltage ( $I_{(BR)} = 100 \mu\text{Adc}$ )	$V_{(BR)}$	75	—	Vdc
Reverse Voltage Leakage Current ( $V_R = 25 \text{ Vdc}, T_J = 150^\circ\text{C}$ ) ( $V_R = 70 \text{ Vdc}$ ) ( $V_R = 70 \text{ Vdc}, T_J = 150^\circ\text{C}$ )	$I_R$	—	30 2.5 50	$\mu\text{Adc}$
Diode Capacitance ( $V_R = 0, f = 1.0 \text{ MHz}$ )	$C_D$	—	2	pF
Forward Voltage ( $I_F = 1.0 \text{ mAdc}$ ) ( $I_F = 10 \text{ mAdc}$ ) ( $I_F = 50 \text{ mAdc}$ ) ( $I_F = 150 \text{ mAdc}$ )	$V_F$	—	715 855 1000 1250	mVdc
Reverse Recovery Time ( $I_F = I_R = 10 \text{ mAdc}, I_{R(REC)} = 1.0 \text{ mAdc}$ ) (Figure 1) $R_L = 100 \Omega$	$t_{rr}$	—	4.0	ns

1. FR-5 = 1.0 X 0.75 X 0.062 in. 2. Alumina = 0.4 X 0.3 X 0.024 in. 99.5% alumina.

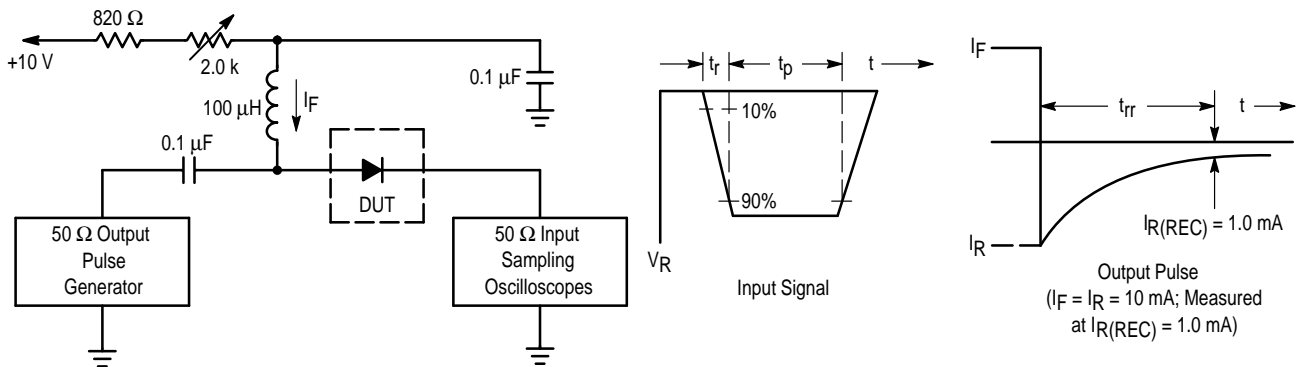

- Notes: 1. A 2.0 kΩ variable resistor adjusted for a Forward Current ( $I_F$ ) of 10 mA.  
2. Input pulse is adjusted so  $I_R(\text{peak})$  is equal to 10 mA.  
3.  $t_p \gg t_{rr}$

**Figure 1. Recovery Time Equivalent Test Circuit**

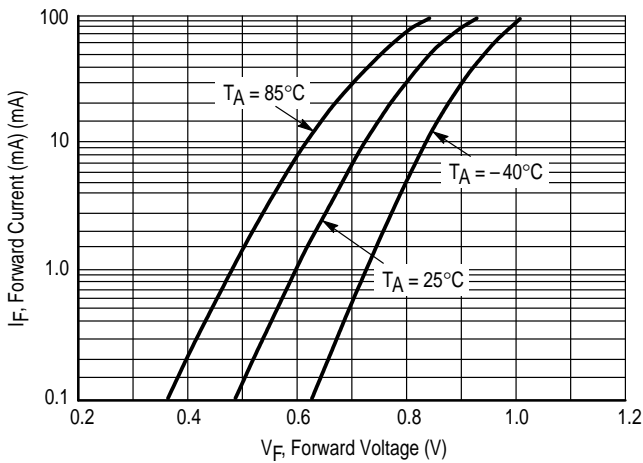

**Figure 2. Forward Voltage**

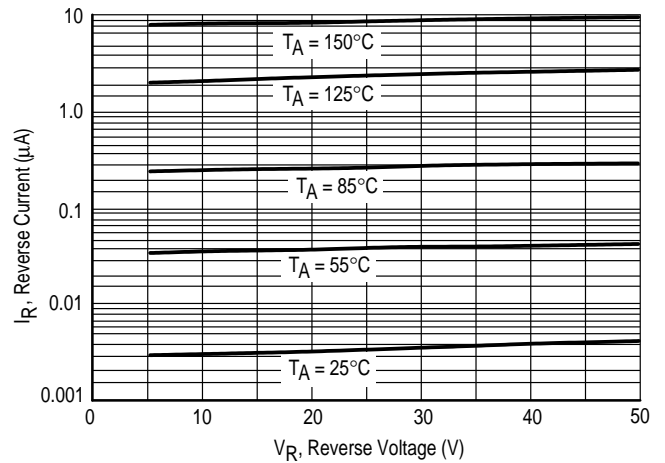

**Figure 3. Leakage Current**

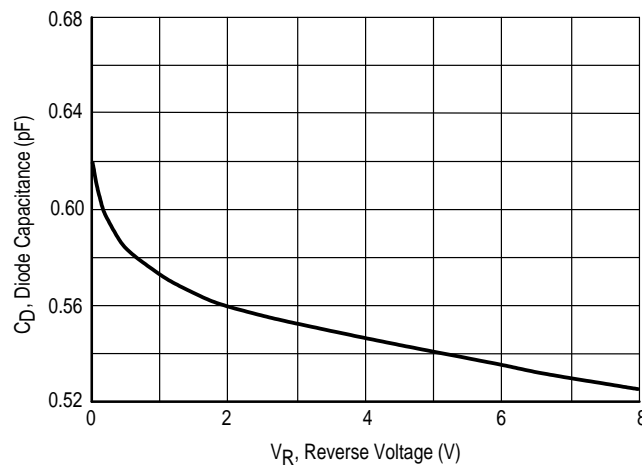

**Figure 4. Capacitance**