

KBU10005-G Thru. KBU1010-G

Reverse Voltage: 50 to 1000V

Forward Current: 10.0A

RoHS Device

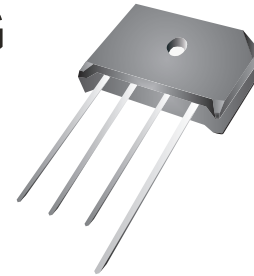

Features

- Surge overload rating - 240 amperes peak.
- Ideal for printed circuit board.

Mechanical Data

- Epoxy: U/L 94-V0 rate flame retardant.
- Case: Molded plastic, KBU
- Mounting position: Any
- Weight: 7.40grams

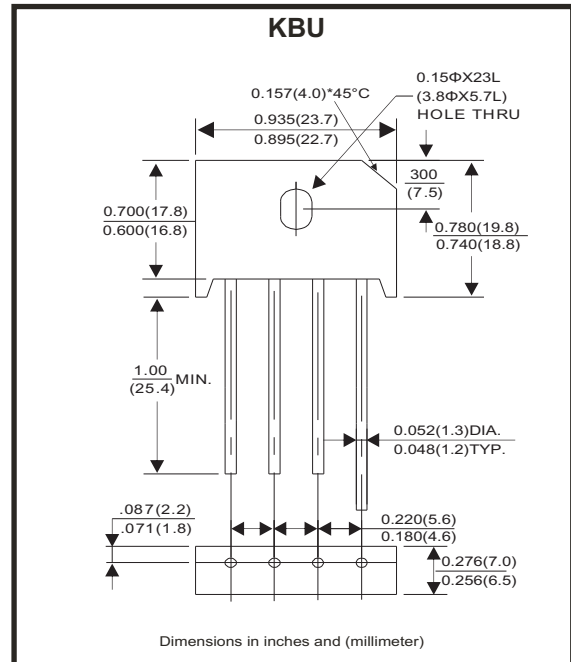

Maximum ratings and electrical characteristics

Rating at 25°C ambient temperature unless otherwise specified.
 Single phase, half wave, 60Hz, resistive or inductive load.
 For capacitive load, derate current by 20%

Parameter	Symbol	KBU 10005-G	KBU 1001-G	KBU 1002-G	KBU 1004-G	KBU 1006-G	KBU 1008-G	KBU 1010-G	Unit
Maximum Reverse Peak Repetitive Voltage	V_{RRM}	50	100	200	400	600	800	1000	V
Maximum RMS Bridge Input Voltage	V_{RMS}	35	70	140	280	420	560	700	V
Maximum DC Blocking Voltage	V_{DC}	50	100	200	400	600	800	1000	V
Maximum Average Forward (With heatsink Note2) Rectified Current @ $T_c=100^\circ\text{C}$ (without heatsink)	I_{AV}					10.0			A
						3.0			
Peak Forward Surge Current, 8.3ms Single Half Sine-Wave Super Imposed On Rated Load	I_{FSM}					240			A
Maximum Forward Voltage at 5.0A	V_F					1.0			V
Maximum Reverse Current @ $T_J=25^\circ\text{C}$ At Rate DC Blocking Voltage @ $T_J=125^\circ\text{C}$	I_R					10.0			μA
						500			
Operating Temperature Range	T_J					-55 to +125			$^\circ\text{C}$
Storage Temperature Range	T_{STG}					-55 to +150			$^\circ\text{C}$

Notes:

1. Device mounted on 100mm*100mm*1.6mm Cu plate heatsink.

Fig.1 - Derating Curve Output Rectified Current

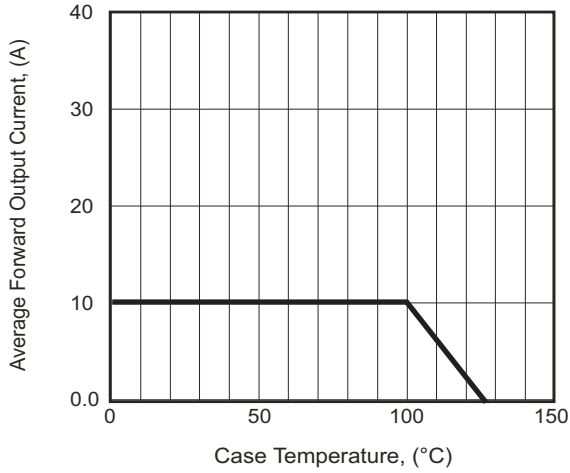

Fig.2 - Typical Forward Characteristics

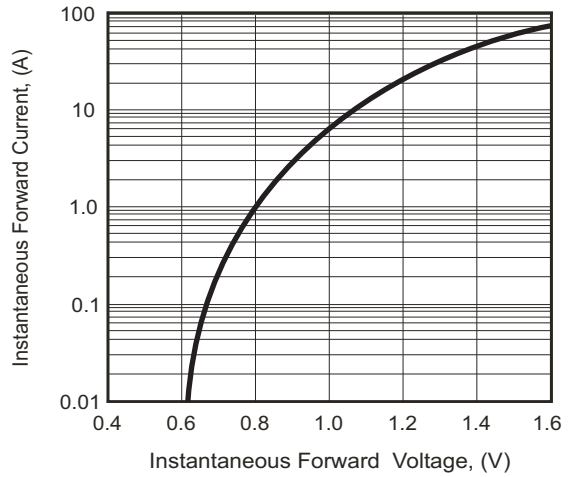

Fig.3 - Maximum Forward Surge Current

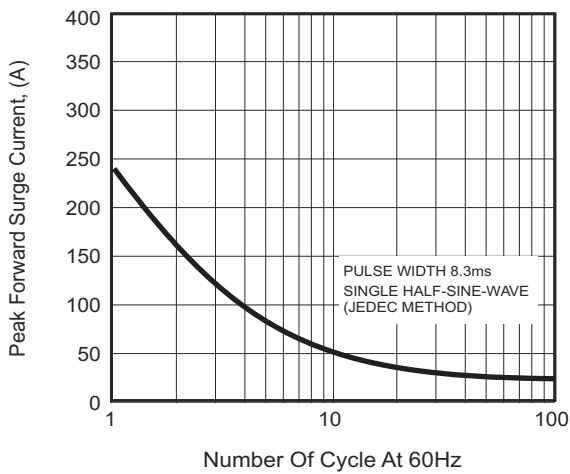
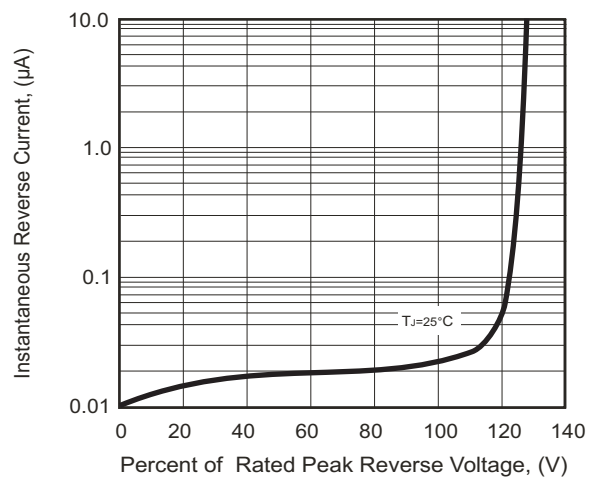
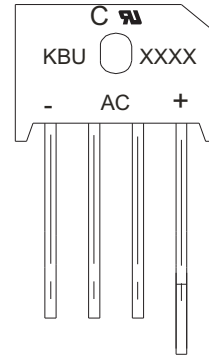

Fig.4 - Typical Reverse Characteristics



Marking Code

Part Number	Marking code
KBU10005-G	KBU10005
KBU1001-G	KBU1001
KBU1002-G	KBU1002
KBU1004-G	KBU1004
KBU1006-G	KBU1006
KBU1008-G	KBU1008
KBU1010-G	KBU1010



XXXX / XXXXX = Product type marking code
 C = Comchip Logo

Standard Packaging

Case Type	BULK PACK	
	BOX (pcs)	CARTON (pcs)
KBU	400	2,400