



EVERLIGHT ELECTRONICS CO.,LTD.

DATA SHEET

PART NO. : 333-2SYGD/S530-E2

DATE : 2002/7/8

DEPARTMENT : CHR&D1

REVISION : 2

RECEIVED			
<input checked="" type="checkbox"/> MASS PRODUCTION			
<input type="checkbox"/> PRELIMINARY			
<input type="checkbox"/> CUSTOMER DESIGN			
DEVICE NUMBER :		CDLE-033-694	
PAGE :		4	
CUSTOMER	DESIGNER	CHECKER	APPROVER

2	Revision Update	2002/8/2
REV.	DESCRIPTION	RELEASE DATE

Office : 7C Building, Lian Hua Port Industrial District, Lian Hua Shan
 Bonded Processing Zone Pan Yu, Guang Zhou, China
 TEL : (020)84860913,84860914
 FAX : (020)84860600
[http : //www.everlight.com](http://www.everlight.com)



EVERLIGHT ELECTRONICS CO.,LTD.

Device Number: CDLE-033-694 REV.: 2

5.0mm Round Type LED Lamps

PART NO.: 333-2SYGD/S530-E2

ECN: _____ Page: 1/4

■ Features :

- Choice of various viewing angles
- Available on tape and reel.
- Reliable and robust

■ Descriptions :

- The series is specially designed for applications requiring higher brightness
- The led lamps are available with different colors, intensities,

■ Applications :

- TV set
- Monitor
- Telephone
- Computer

■ Package Dimensions:

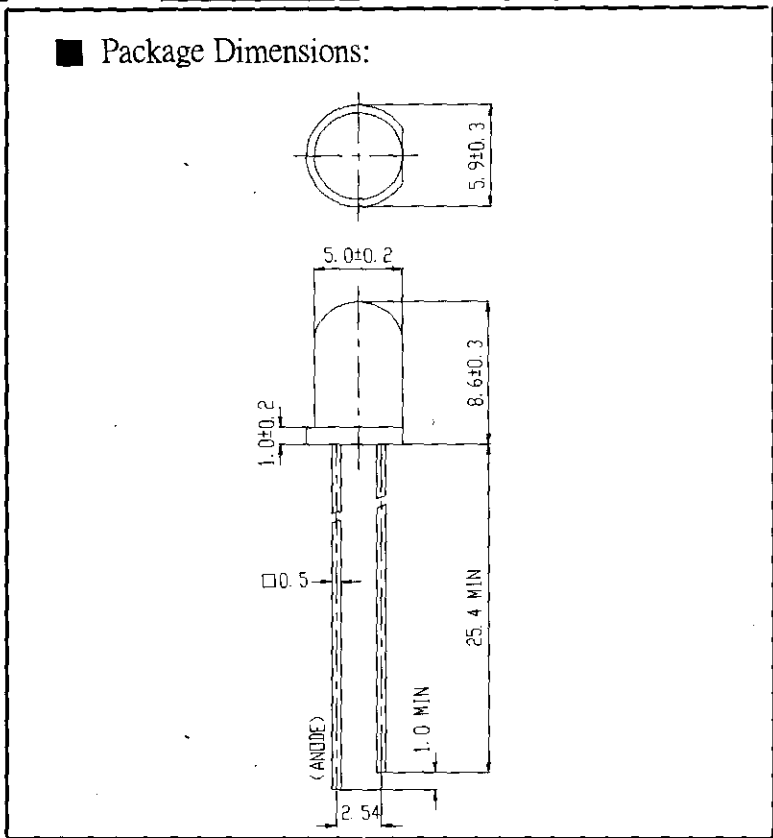

■ Notes :

1. All dimensions are in millimeters.
2. An epoxy meniscus may extend about 1.5mm(0.059") down to the lead.
3. Tolerances unless Dimension ±0.25mm.

PART NO.	Chip		Lens Color
	Material	Emitted Color	
333-2SYGD/S530-E2	AlGaInP	Super Yellow Green	Green Diffused

Office : 7C Building, Lian Hua Port Industrial District, Lian Hua Shan
 Bonded Pricessing Zone Pan Yu, Guang Zhou, China
 TEL : (020)84860913,84860914
 FAX : (020)84860600
 http : //www.everlight.com

T00561,C89113124



EVERLIGHT ELECTRONICS CO.,LTD.

Device Number : CDLE-033-694 REV.: 2

5.0mm Round Type LED Lamps

PART NO. : 333-2SYGD/S530-E2

ECN : _____

Page: 3/4

■ Typical Electro-Optical Characteristic Curves:

(SYG)

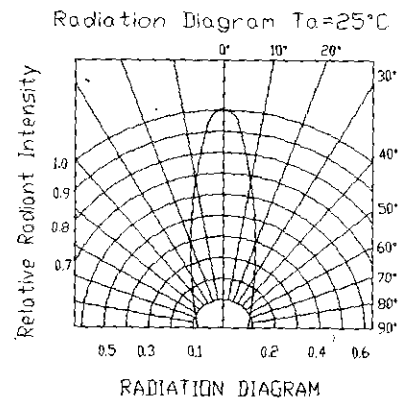
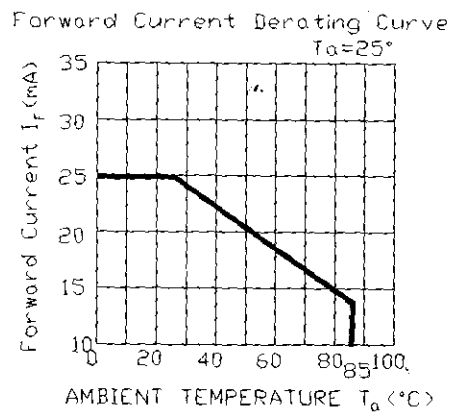
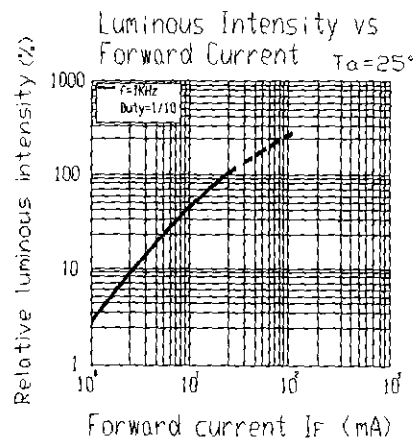
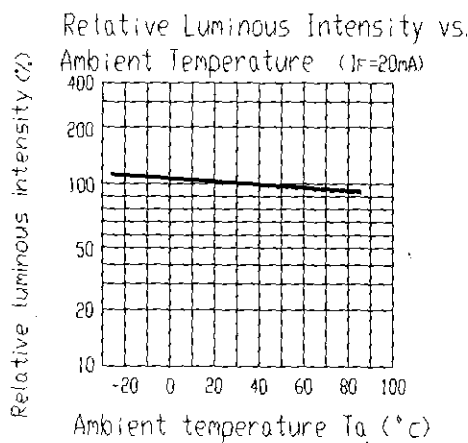
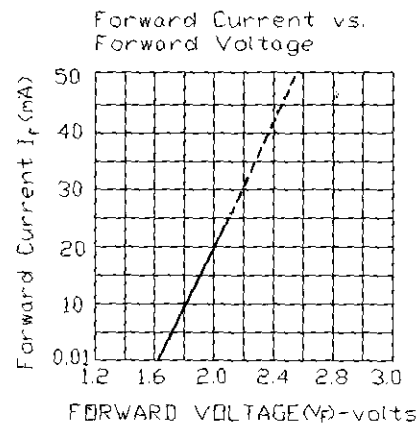
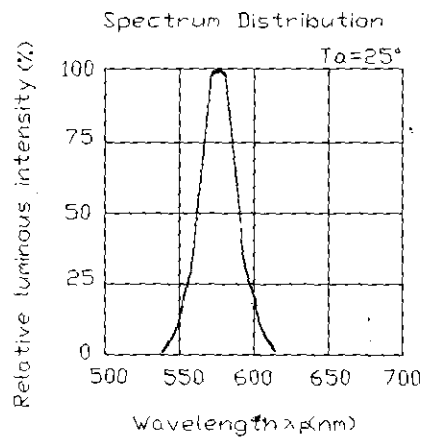



EVERLIGHT ELECTRONICS CO.,LTD.

Device Number : CDLE-033-694 REV.: 2

5.0mm Round Type LED Lamps

PART NO. : 333-2SYGD/S530-E2 ECN : _____ Page: 4/4

■ Reliability test items and conditions:

NO	Item	Test Conditions	Test Hours/Cycle		Ac/Re
1	Solder Heat	TEMP : 260°C ± 5 °C	5 SEC	76 PCS	0/1
2	Temperature Cycle	H : +85°C 30min } 5 min L : -55°C 30min	50 CYCLES	76 PCS	0/1
3	Thermal Shock	H : +100°C 5min } 10 sec L : -10°C 5min	50 CYCLES	76 PCS	0/1
4	High Temperature Storage	TEMP : 100°C	1000 HRS	76 PCS	0/1
5	Low Temperature Storage	TEMP : -55°C	1000 HRS	76 PCS	0/1
6	DC Operating Life	TEMP : 25°C If = 20mA	1000 HRS	76 PCS	0/1
7	High Temperature / High Humidity	85°C / 85% RH	1000 HRS	76 PCS	0/1