



Push-Pull FET Driver with Integrated Oscillator and Clock Output

MAX5075

General Description

The MAX5075 is a +4.5V to +15V push-pull, current-fed topology driver subsystem with an integrated oscillator for use in telecom module power supplies. The device drives two MOSFETs connected to a center-tapped transformer primary providing secondary-side, isolated, negative or positive voltages. This device features a programmable, accurate, integrated oscillator with a synchronizing clock output that synchronizes an external PWM regulator. A single external resistor programs the internal oscillator frequency from 50kHz to 1.5MHz.

The MAX5075 incorporates a dual MOSFET driver with $\pm 3A$ peak drive currents and 50% duty cycle. The MOSFET driver generates complementary signals to drive external ground-referenced n-channel MOSFETs.

The MAX5075 is available with a clock output frequency to MOSFET driver frequency ratio of 1x, 2x, and 4x. The MAX5075 is available in a thermally enhanced 8-pin $\mu\text{MAX}^{\text{®}}$ package and is specified over the -40°C to $+125^{\circ}\text{C}$ operating temperature range.

Applications

Current-Fed, High-Efficiency Power-Supply Modules
Power-Supply Building Subsystems
Push-Pull Driver Subsystems

μMAX is a registered trademark of Maxim Integrated Products, Inc.

Pin Configuration appears at end of data sheet.

Features

- ◆ Current-Fed, Push-Pull Driver Subsystem
- ◆ Programmable, Accurate Internal Oscillator
- ◆ Single +4.5V to +15V Supply Voltage Range
- ◆ Dual $\pm 3A$ Gate-Drive Outputs
- ◆ 1mA Operating Current at 250kHz with No Capacitive Load
- ◆ Synchronizing Clock Frequency Generation Options
- ◆ Thermally Enhanced 8-Pin μMAX Package
- ◆ -40°C to $+125^{\circ}\text{C}$ Operating Temperature Range

Ordering Information

PART	PIN-PACKAGE	TOP MARK	PKG CODE	$f_{\text{CLK}}/f_{\text{NDRV_}}_{\text{RATIO}}$
MAX5075AAUA	8 $\mu\text{MAX-EP}^*$	AAAU	U8E-2	1
MAX5075BAUA	8 $\mu\text{MAX-EP}^*$	AAAV	U8E-2	2
MAX5075CAUA	8 $\mu\text{MAX-EP}^*$	AAAW	U8E-2	4

*EP = Exposed paddle.

Note: All devices specified for -40°C to $+125^{\circ}\text{C}$ operating temperature range.

Typical Operating Circuit

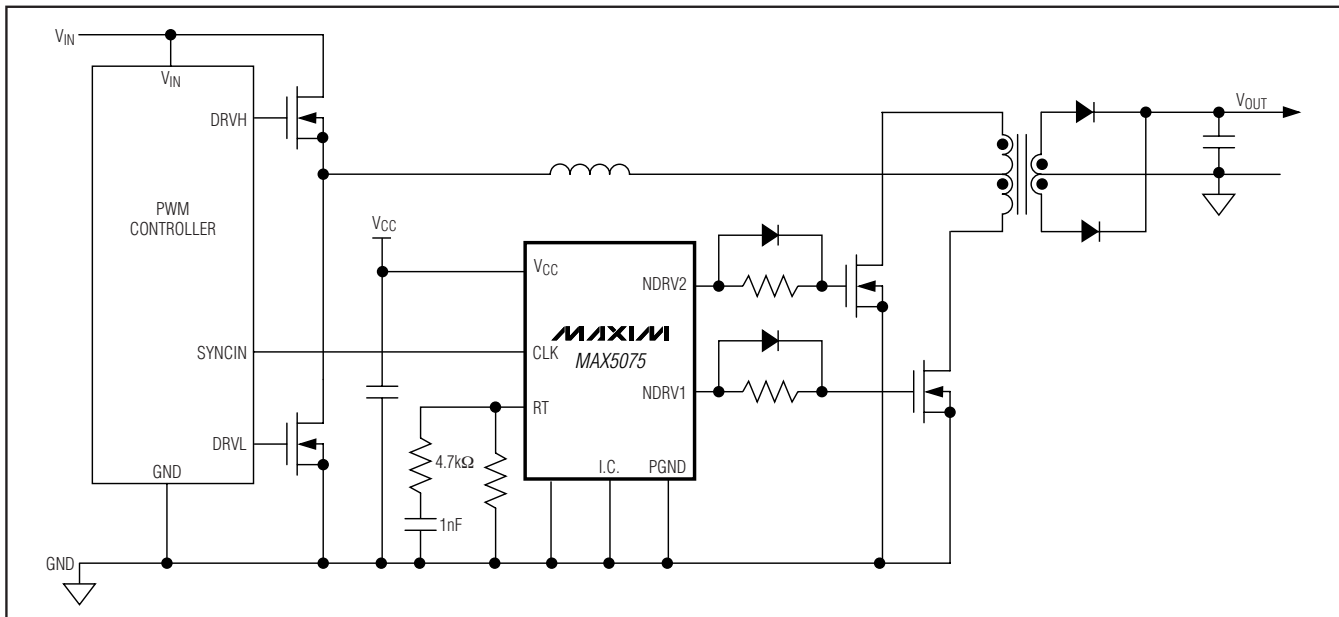

Push-Pull FET Driver with Integrated Oscillator and Clock Output

ABSOLUTE MAXIMUM RATINGS

V _{CC} to DGND, PGND	-0.3V to +18V
CLK, RT to DGND.....	-0.3V to +6V
NDRV1, NDRV2 to PGND.....	-0.3V to (V _{CC} + 0.3V)
DGND to PGND.....	-0.3V to +0.3V
CLK Current.....	±20mA
NDRV1, NDRV2 Peak Current (200ns).....	±5A
NDRV1, NDRV2 Reverse Current (Latchup Current).....	±500mA

Continuous Power Dissipation (T _A = +70°C)	
8-Pin μMAX (derate 10.3mW/°C above +70°C)	825mW
Operating Temperature Range	-40°C to +125°C
Maximum Junction Temperature	+150°C
Storage Temperature Range	-60°C to +150°C
Lead Temperature (soldering, 10s).....	+300°C

Stresses beyond those listed under "Absolute Maximum Ratings" may cause permanent damage to the device. These are stress ratings only, and functional operation of the device at these or any other conditions beyond those indicated in the operational sections of the specifications is not implied. Exposure to absolute maximum rating conditions for extended periods may affect device reliability.

ELECTRICAL CHARACTERISTICS

(V_{CC} = +12V, R_{RT} = 124kΩ, NDRV1 = NDRV2 = open, T_A = T_J = -40°C to +125°C, unless otherwise noted. Typical values are measured at T_A = +25°C.) (Note 1)

PARAMETER	SYMBOL	CONDITIONS	MIN	TYP	MAX	UNITS
SUPPLY						
Input Voltage Supply Range	V _{CC}		4.5		15.0	V
Switching Supply Current	I _{CCSW}	f _{OSC} = 250kHz		1	3	mA
Undervoltage Lockout	V _{UVLO}	V _{CC} rising	3	3.5	4	V
UVLO Hysteresis				300		mV
OSCILLATOR						
Frequency Range	f _{OSC}	(Note 2)	50		1500	kHz
Accuracy		f _{OSC} = 250kHz, 6V ≤ V _{CC} ≤ 15V (Note 3)	-8		+10	%
Oscillator Jitter				±0.6		%
CLK Output High Voltage		I _{CLK} = 1mA	7V ≤ V _{CC} ≤ 15V 4.5V ≤ V _{CC} ≤ 7V	3.9	5.0	V
CLK Output Low Voltage		I _{CLK} = -1mA			50	mV
CLK Output Rise Time		C _{CLK} = 30pF		35		ns
CLK Output Fall Time		C _{CLK} = 30pF		10		ns
GATE DRIVERS (NDRV1, NDRV2)						
Output High Voltage	V _{OH}	I _{NDRV1} = I _{NDRV2} = 100mA	V _{CC} - 0.3			V
Output Low Voltage	V _{OL}	I _{NDRV1} = I _{NDRV2} = -100mA			0.3	V
Output Peak Current	I _P	Sourcing and sinking		3		A
Driver Output Impedance		NDRV_ sourcing 100mA NDRV_ sinking 100mA		1.8 1.6	3 2.6	Ω
Latchup Current Protection		Reverse current at NDRV1/NDRV2		400		mA
Rise Time	t _R	C _{LOAD} = 2nF		10		ns
Fall Time	t _F	C _{LOAD} = 2nF		10		ns

Note 1: The MAX5075 is 100% tested at T_A = T_J = +125°C. All limits over temperature are guaranteed by design.

Note 2: Use the following formula to calculate the MAX5075 oscillator frequency: f_{OSC} = 10¹²/(32 × R_{RT}).

Note 3: The accuracy of the oscillator's frequency is lower at frequencies greater than 1MHz.

Push-Pull FET Driver with Integrated Oscillator and Clock Output

Typical Operating Characteristics

($V_{CC} = +12V$, $R_{RT} = 124k\Omega$, $NDRV_- = open$, $CLK = open$.)

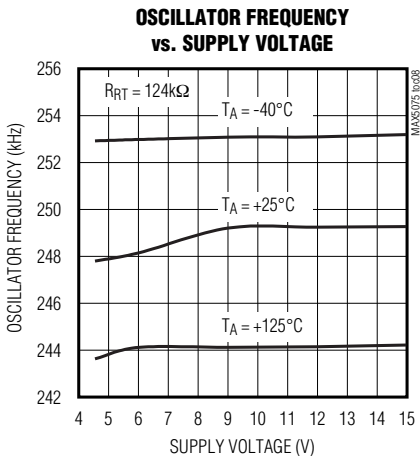
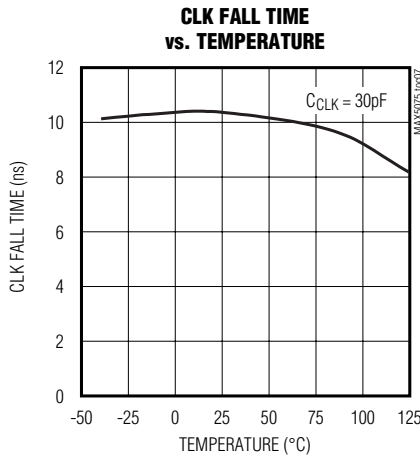
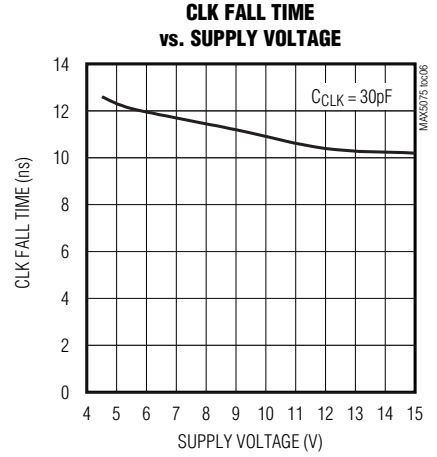
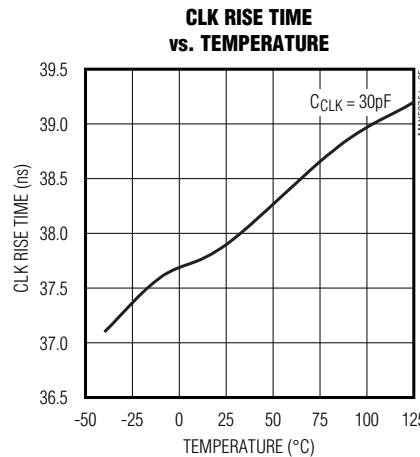
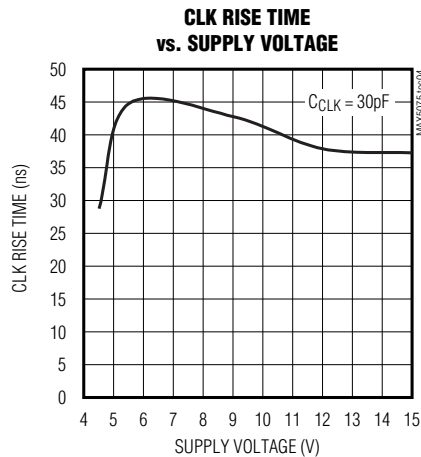
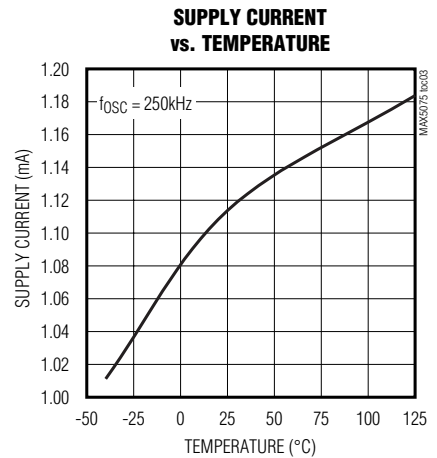
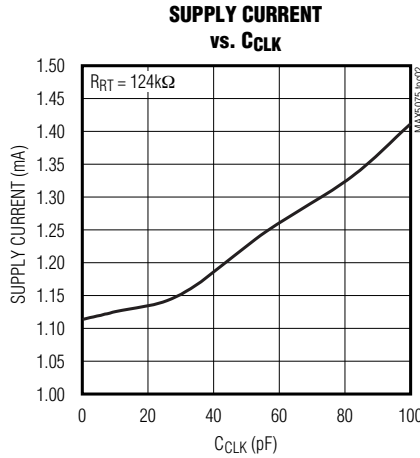
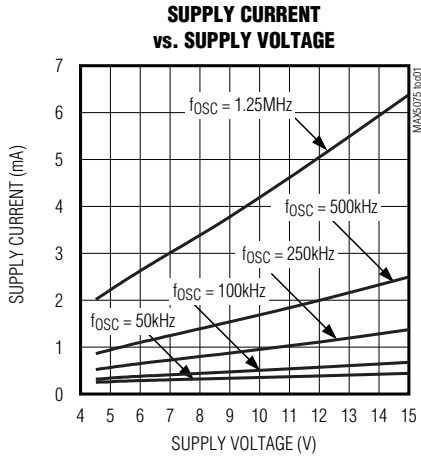

Push-Pull FET Driver with Integrated Oscillator and Clock Output

Typical Operating Characteristics (continued)

(V_{CC} = +12V, R_{RT} = 124kΩ, NDRV₋ = open, CLK = open.)

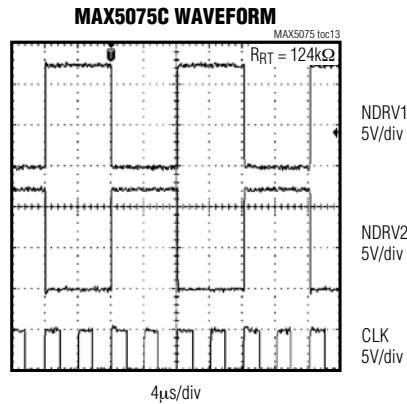
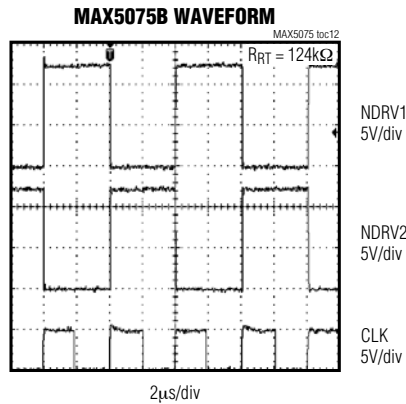
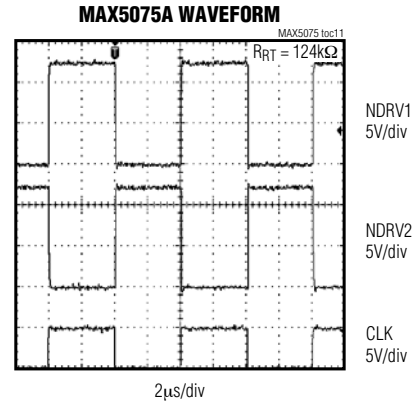
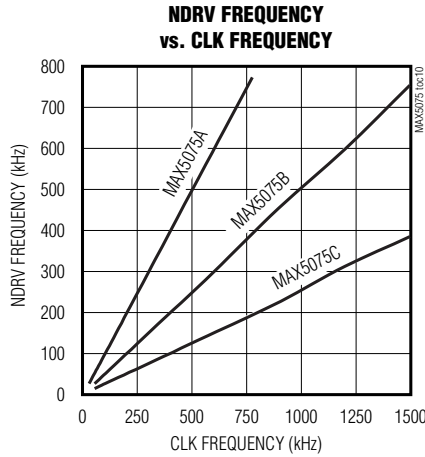
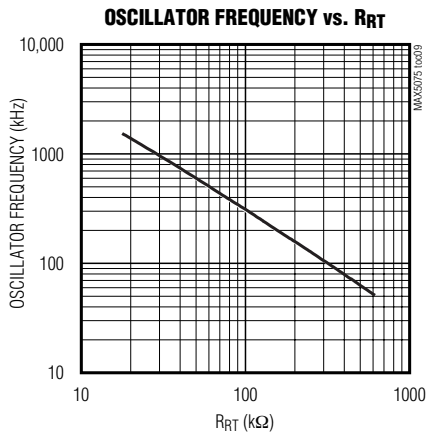

Push-Pull FET Driver with Integrated Oscillator and Clock Output

Pin Description

PIN	NAME	FUNCTION
1	CLK	Synchronizing Clock Output. Clock output with a $\pm 10\text{mA}$ peak current drive that can be used to synchronize an external PWM regulator. CLK/NDRV1 frequency has a 1x, 2x, or 4x ratio. See the <i>Synchronizing Clock Output</i> section.
2	I.C.	Internal Connection. Connect to ground. Internal function.
3	RT	Oscillator Timing Resistor Connection. Bypass RT with a series combination of a $4.7\text{k}\Omega$ resistor and a 1nF capacitor to DGND. Connect a resistor from RT to DGND to set the internal oscillator.
4	DGND	Digital Ground. Connect DGND to ground plane.
5	PGND	Power Ground. Connect PGND to ground plane.
6	NDRV1	Gate Driver 1. Connect NDRV1 to the gate of the external n-channel FET.
7	NDRV2	Gate Driver 2. Connect NDRV2 to the gate of the external n-channel FET.
8	VCC	Power-Supply Input. Bypass VCC to PGND with $0.1\mu\text{F}$ $1\mu\text{F}$ ceramic capacitors.
EP	EP	Exposed Pad. Internally connected to DGND. Connect exposed pad to ground plane.

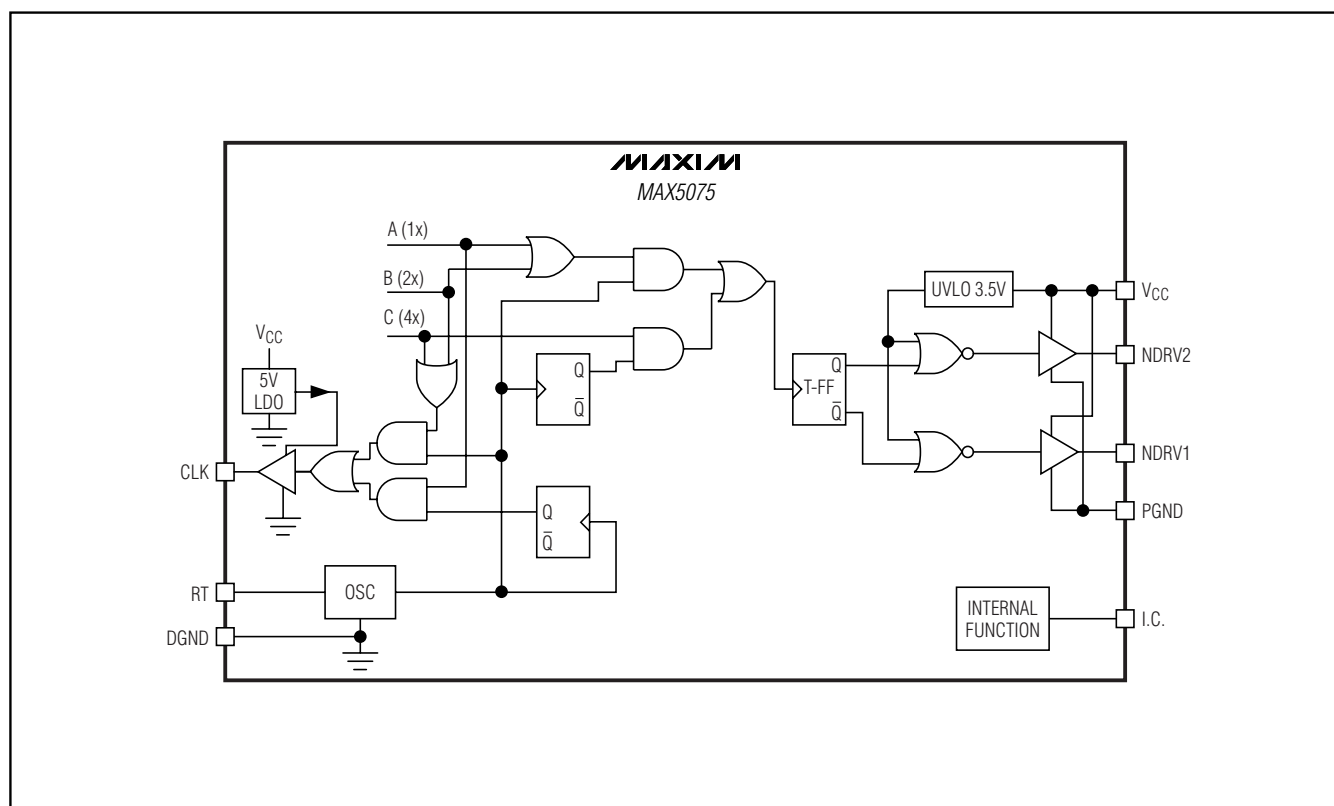

Figure 1. MAX5075 Functional Diagram

Push-Pull FET Driver with Integrated Oscillator and Clock Output

Detailed Description

The MAX5075 is a +4.5V to +15V push-pull, current-fed topology driver subsystem with an integrated oscillator for use in 48V module power supplies.

The MAX5075 features a programmable, accurate integrated oscillator with a synchronizing clock output that can be used to synchronize an external PWM stage. A single external resistor programs the internal oscillator frequency from 50kHz to 1.5MHz.

The MAX5075 incorporates a dual MOSFET driver with $\pm 3A$ peak drive currents and a 50% duty cycle. The MOSFET driver generates complementary signals to drive external ground-referenced n-channel MOSFETs.

The MAX5075 is available with a clock output frequency to MOSFET driver frequency ratios of 1x, 2x, and 4x.

Internal Oscillator

An external resistor at R_T programs the MAX5075 internal oscillator frequency from 50kHz to 1.5MHz. The MAX5075A/B NDRV1 and NDRV2 switching frequencies are one-half the programmed oscillator frequency with a nominal 50% duty cycle. The MAX5075C NDRV1 and NDRV2 switching frequencies are one-fourth the oscillator frequency.

Use the following formula to calculate the internal oscillator frequency:

$$f_{OSC} = \frac{10^{12}}{32 \times R_{RT}}$$

where f_{OSC} is the oscillator frequency and R_{RT} is a resistor connected from R_T to DGND in ohms.

Place a series combination of a 4.7k Ω resistor and a 1nF capacitor from R_T to DGND for stability and to filter out noise.

Synchronizing Clock Output

The MAX5075 provides a buffered clock output that can be used to synchronize the oscillator input of a PWM controller. CLK is powered from an internal 5V regulator and sources/sinks up to 10mA. The MAX5075 has internal CLK output frequency to NDRV1 and NDRV2 switching frequency ratios set to 1x, 2x, or 4x (Table 1).

The MAX5075A has a CLK frequency to NDRV_ frequency ratio set to 1x. The MAX5075B has a CLK frequency to NDRV_ frequency ratio set to 2x and the MAX5075C has a CLK frequency to NDRV_ frequency ratio set to 4x. There is a typical 30ns delay from CLK to NDRV_ output.

Table 1. MAX5075 CLK Output Frequency

PART	f _{CLK}	f _{NDRV1}	f _{CLK} to f _{sw} RATIO
MAX5075A	$f_{OSC} / 2$	$f_{OSC} / 2$	1
MAX5075B	f_{OSC}	$f_{OSC} / 2$	2
MAX5075C	f_{OSC}	$f_{OSC} / 4$	4

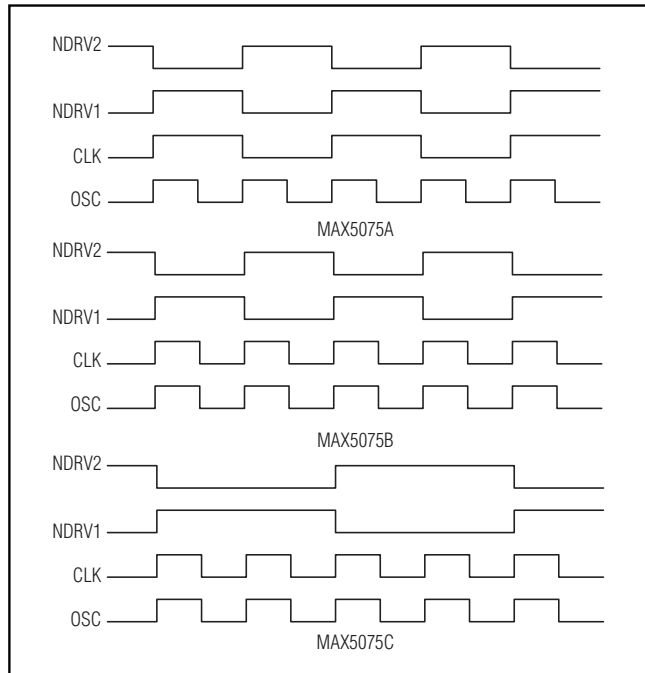

Figure 2. MAX5075 CLK Timing Diagrams

Applications Information

Supply Bypassing

Pay careful attention to bypassing and grounding the MAX5075. Peak supply and output currents may exceed 3A when driving large MOSFETs. Ground shifts due to insufficient device grounding may also disturb other circuits sharing the same ground-return path. Any series inductance in the V_{CC} , NDRV1, NDRV2, and/or GND paths can cause noise due to the very high di/dt when switching the MAX5075 with any capacitive load. Place one or more 0.1 μ F ceramic capacitors in parallel as close to the device as possible to bypass V_{CC} to PGND. Use a ground plane to minimize ground-return resistance and inductance. Place the external MOSFETs as close as possible to the MAX5075 to further minimize board inductance and AC path impedance.

Push-Pull FET Driver with Integrated Oscillator and Clock Output

Power Dissipation

The power dissipation of the MAX5075 is a function of the sum of the quiescent current and the output current (either capacitive or resistive load). Maintain the sum of the currents so the maximum power dissipation limit is not exceeded. The power dissipation (P_{DISS}) due to the quiescent switching supply current (I_{CCSW}) can be calculated as:

$$P_{DISS} = V_{CC} \times I_{CCSW}$$

For capacitive loads, use the following equation to estimate the power dissipation:

$$P_{LOAD} = 2 \times C_{LOAD} \times V_{CC}^2 \times f_{NDRV_}$$

where C_{LOAD} is the capacitive load at NDRV1 and NDRV2, V_{CC} is the supply voltage, and $f_{NDRV_}$ is the MAX5075 NDRV_ switching frequency.

Calculate the total power dissipation (P_T) as follows:

$$P_T = P_{DISS} + P_{LOAD}$$

Layout Recommendations

The MAX5075 sources and sinks large currents that can create very fast rise and fall edges at the gate of the switching MOSFETs. The high di/dt can cause unacceptable ringing if the trace lengths and impedances are not well controlled. Use the following PC board layout guidelines when designing with the MAX5075:

- Place one or more 0.1 μ F decoupling ceramic capacitors from V_{CC} to PGND as close to the device as possible. Connect V_{CC} and all ground pins to large copper areas. Place one bulk capacitor of 10 μ F on the PC board with a low-impedance path to the V_{CC} input and PGND of the MAX5075.

- Two AC current loops form between the device and the gate of the driven MOSFETs. The MOSFETs look like a large capacitance from gate to source when the gate pulls low. The current loop is from the MOSFET gate to NDRV1 and NDRV2 of the MAX5075, to PGND, and to the source of the MOSFET. When the gate of the MOSFET pulls high, the current is from the V_{CC} terminal of the decoupling capacitor, to V_{CC} of the MAX5075, to NDRV1 and NDRV2, and to the MOSFET gate and source. Both charging current and discharging current loops are important. Minimize the physical distance and the impedance in these AC current paths.
- Keep the device as close to the MOSFET as possible.

Pin Configuration

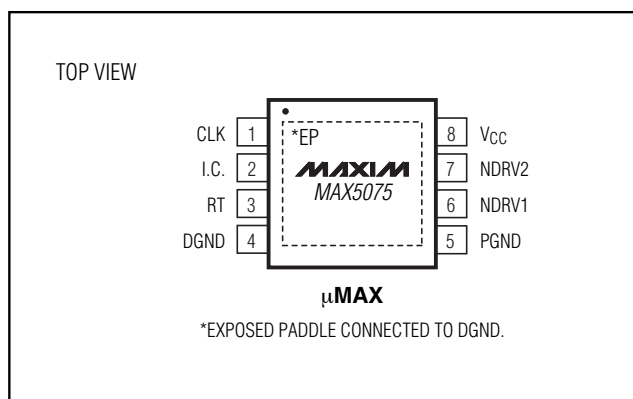

Chip Information

TRANSISTOR COUNT: 1335

PROCESS: BiCMOS

Push-Pull FET Driver with Integrated Oscillator and Clock Output

Package Information

(The package drawing(s) in this data sheet may not reflect the most current specifications. For the latest package outline information go to www.maxim-ic.com/packages.)

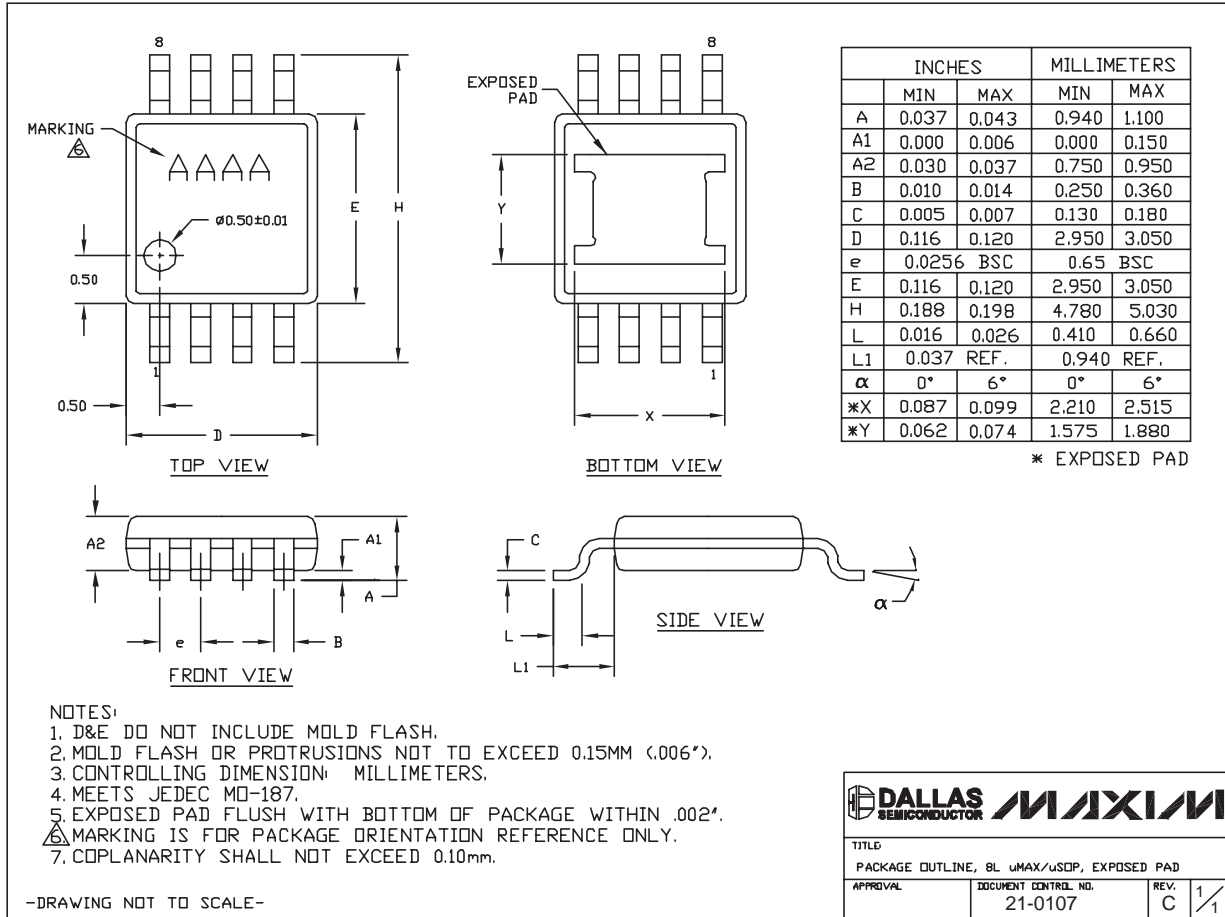

8L, uMAX, EXP PAD EPS

Revision History

Pages changed at Rev 1: 1, 2, 5, 6, 8

Maxim cannot assume responsibility for use of any circuitry other than circuitry entirely embodied in a Maxim product. No circuit patent licenses are implied. Maxim reserves the right to change the circuitry and specifications without notice at any time.

8 Maxim Integrated Products, 120 San Gabriel Drive, Sunnyvale, CA 94086 408-737-7600