

RA3505 ... RA358

Silicon-Rectifiers – Button Diodes Silizium-Gleichrichter – Knopf-Zellen

Version 2008-10-30

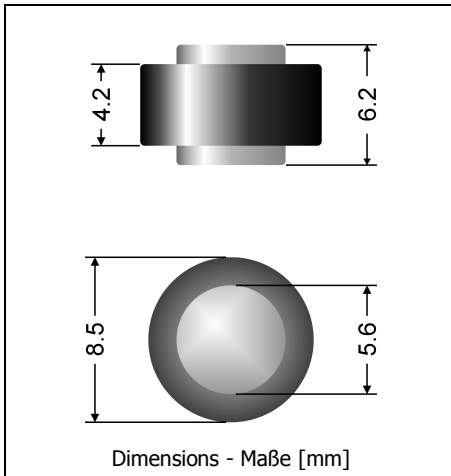

Nominal current Nennstrom	35 A
Repetitive peak reverse voltage Periodische Spitzensperrspannung	50 ... 800 V
Plastic case Kunststoffgehäuse	Button
Weight approx. Gewicht ca.	1.9 g
Plastic material has UL classification 94V-0 Gehäusematerial UL94V-0 klassifiziert	
Standard packaging bulk Standard Lieferform lose	



Marking: Colored ring denotes "cathode"
Kennzeichnung: Farbiger Ring kennzeichnet "Kathode"

Maximum ratings

Grenzwerte

Type Typ	Repetitive peak reverse voltage Periodische Spitzensperrspannung V_{RRM} [V]	Surge peak reverse voltage Stoßspitzensperrspannung V_{RSM} [V]
RA3505	50	50
RA351	100	100
RA352	200	200
RA354	400	400
RA356	600	600
RA358	800	800

Max. average forward rectified current, R-load Dauerstrom in Einwegschaltung mit R-Last	$T_C = 110^\circ\text{C}$	I_{FAV}	35 A
Peak forward surge current, 50/60 Hz half sine-wave Stoßstrom für eine 50/60 Hz Sinus-Halbwellen		I_{FSM}	450/500 A
Rating for fusing, $t < 10$ ms Grenzlastintegral, $t < 10$ ms	$T_A = 25^\circ\text{C}$	i^2t	1000 A ² s
Junction temperature – Sperrschichttemperatur Storage temperature – Lagerungstemperatur		T_j T_s	-50...+175°C -50...+175°C

Characteristics
Kennwerte

Forward Voltage – Durchlass-Spannung	$T_j = 25^\circ\text{C}$	$I_F = 80\text{ A}$	V_F	< 1.1 V	
Leakage current Sperrstrom	$T_j = 25^\circ\text{C}$	$V_R = V_{RRM}$	I_R	< 5 μA	
	$T_j = 100^\circ\text{C}$	$V_R = V_{RRM}$	I_R	< 250 μA	
Thermal resistance junction to case (terminal) Wärmewiderstand Sperrschicht – Gehäuse (Anschluss)				R_{thc}	< 1.0 K/W

