



SANYO Semiconductors

# DATA SHEET

An ON Semiconductor Company

## 15GN03FA — NPN Epitaxial Planar Silicon Transistor VHF High-frequency Amplifier Applications

### Applications

- VHF, RF, MIXER, OSC, IF amplifier

### Features

- High cutoff frequency :  $f_T=1.5\text{GHz}$  typ
- High gain :  $|S_{21e}|^2=14\text{dB}$  typ ( $f=0.4\text{GHz}$ )
- Ultrasmall package permitting applied sets to be small and slim
- Halogen free compliance

### Specifications

Absolute Maximum Ratings at  $T_a=25^\circ\text{C}$

Parameter	Symbol	Conditions	Ratings	Unit
Collector-to-Base Voltage	$V_{CBO}$		20	V
Collector-to-Emitter Voltage	$V_{CEO}$		10	V
Emitter-to-Base Voltage	$V_{EBO}$		3	V
Collector Current	$I_C$		70	mA
Collector Dissipation	$P_C$		250	mW
Junction Temperature	$T_J$		150	$^\circ\text{C}$
Storage Temperature	$T_{stg}$		-55 to +150	$^\circ\text{C}$

### Package Dimensions

unit : mm (typ)

7029A-002

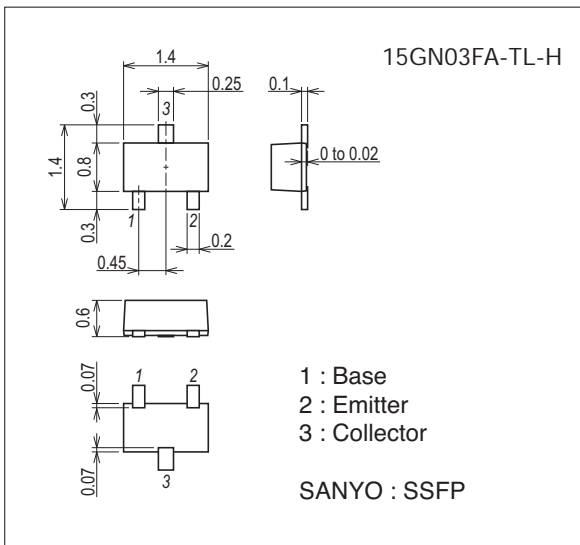

### Product & Package Information

- Package : SSFP
- JEITA, JEDEC : SC-81
- Minimum Packing Quantity : 8,000 pcs./reel

### Packing Type: TL

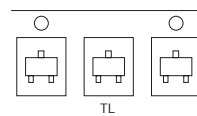

### Marking

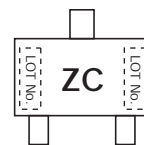

### Electrical Connection

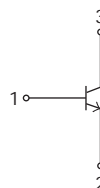

# 15GN03FA

## Electrical Characteristics at Ta=25°C

Parameter	Symbol	Conditions	Ratings			Unit
			min	typ	max	
Collector Cutoff Current	$I_{CBO}$	$V_{CB}=10V, I_E=0A$			0.1	$\mu A$
Emitter Cutoff Current	$I_{EBO}$	$V_{EB}=2V, I_C=0A$			1	$\mu A$
DC Current Gain	$h_{FE}$	$V_{CE}=5V, I_C=10mA$	100		180	
Gain-Bandwidth Product	$f_T$	$V_{CE}=5V, I_C=20mA$	1.0	1.5		GHz
Output Capacitance	$C_{ob}$	$V_{CB}=10V, f=1MHz$		0.9	1.2	pF
Reverse Transfer Capacitance	$C_{re}$				0.6	pF
Forward Transfer Gain	$ S_{21e} ^2$	$V_{CE}=5V, I_C=20mA, f=0.4GHz$	11	14		dB
Noise Figure	NF	$V_{CE}=3V, I_C=2mA, f=0.4GHz$		1.6		dB

## Ordering Information

Device	Package	Shipping	memo
15GN03FA-TL-H	SSFP	8,000pcs./reel	Pb Free and Halogen Free

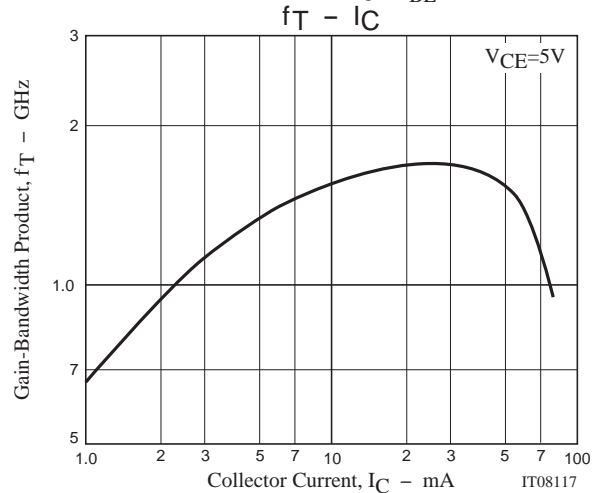
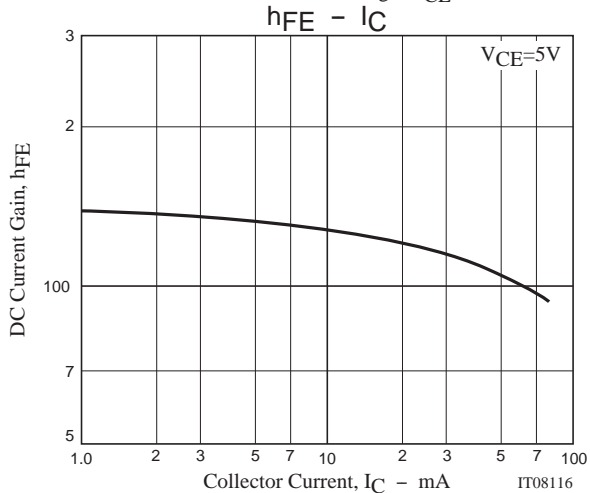
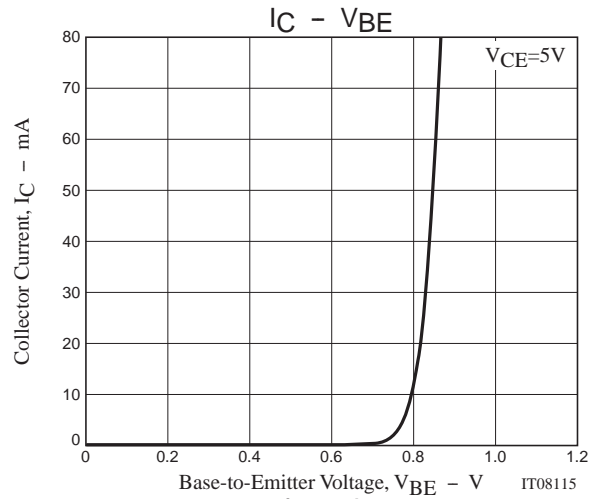
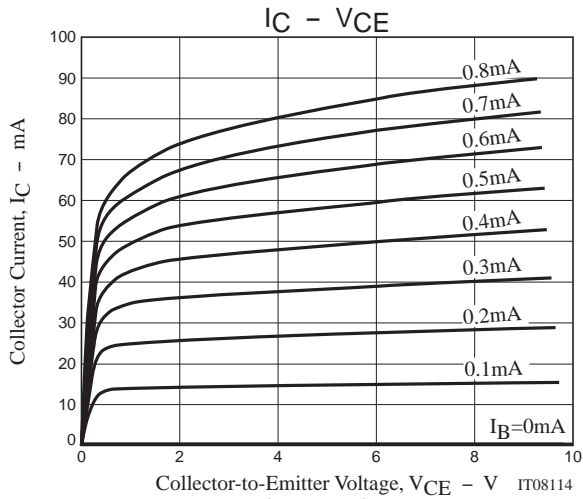

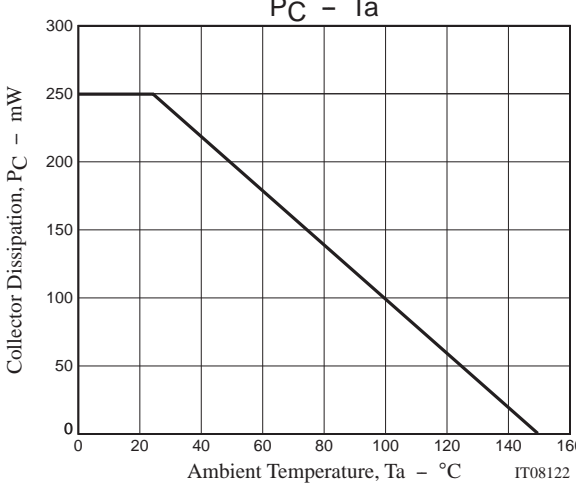
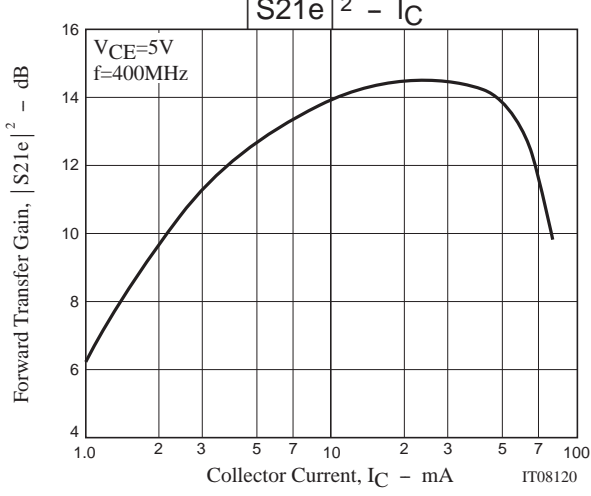
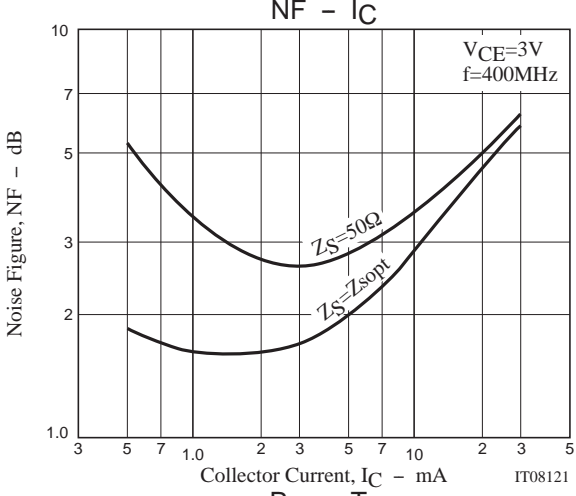
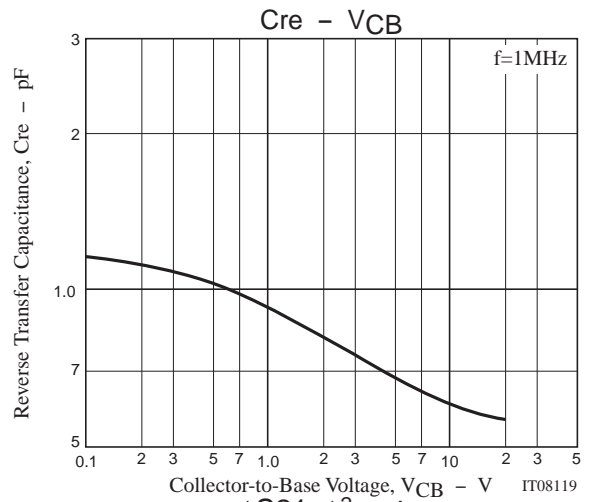
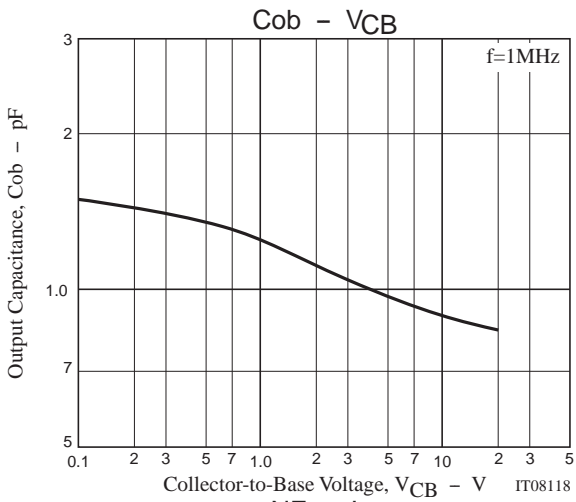

# 15GN03FA

## S Parameters (Common emitter)

$V_{CE}=5V, I_C=1mA, Z_O=50\Omega$

Freq(MHz)	S11	$\angle S11$	S21	$\angle S21$	S12	$\angle S12$	S22	$\angle S22$
100	0.961	-34.18	3.294	157.68	0.040	70.32	0.974	-8.70
200	0.932	-63.71	2.882	139.23	0.068	53.42	0.920	-15.14
300	0.907	-86.85	2.472	124.36	0.087	40.84	0.873	-19.79
400	0.887	-104.47	2.112	112.52	0.096	32.90	0.842	-23.48
500	0.871	-117.78	1.834	102.94	0.099	28.12	0.818	-26.33
600	0.859	-128.62	1.605	94.86	0.101	23.64	0.802	-29.35
700	0.857	-137.14	1.432	87.95	0.097	19.29	0.798	-32.27
800	0.850	-144.21	1.289	81.60	0.095	17.58	0.796	-35.02
900	0.845	-150.72	1.176	76.29	0.090	17.23	0.797	-38.01
1000	0.839	-156.10	1.081	70.99	0.085	16.55	0.797	-41.02

$V_{CE}=5V, I_C=3mA, Z_O=50\Omega$

Freq(MHz)	S11	$\angle S11$	S21	$\angle S21$	S12	$\angle S12$	S22	$\angle S22$
100	0.892	-58.77	8.161	145.03	0.034	56.36	0.902	-14.46
200	0.843	-98.07	6.099	122.67	0.051	42.43	0.786	-20.13
300	0.817	-121.82	4.658	108.72	0.055	33.87	0.727	-22.56
400	0.803	-136.85	3.715	98.70	0.058	30.68	0.700	-24.99
500	0.792	-146.48	3.051	91.64	0.058	28.74	0.687	-26.83
600	0.786	-154.00	2.599	85.58	0.058	29.60	0.678	-29.37
700	0.788	-159.54	2.257	80.45	0.056	31.43	0.677	-32.02
800	0.787	-164.23	2.001	75.47	0.055	35.06	0.680	-34.73
900	0.784	-168.41	1.798	71.27	0.054	40.40	0.683	-37.51
1000	0.782	-171.95	1.635	67.12	0.056	43.46	0.687	-40.32

$V_{CE}=5V, I_C=5mA, Z_O=50\Omega$

Freq(MHz)	S11	$\angle S11$	S21	$\angle S21$	S12	$\angle S12$	S22	$\angle S22$
100	0.836	-76.63	11.501	136.45	0.030	52.40	0.838	-17.51
200	0.798	-117.27	7.726	114.17	0.040	37.48	0.709	-21.18
300	0.781	-137.77	5.593	101.72	0.043	34.01	0.658	-22.46
400	0.773	-149.33	4.358	93.38	0.044	33.11	0.638	-24.37
500	0.769	-156.90	3.532	87.35	0.046	36.56	0.630	-26.09
600	0.766	-162.43	2.982	81.95	0.045	39.81	0.625	-28.60
700	0.769	-167.07	2.577	77.34	0.045	42.61	0.624	-31.24
800	0.770	-170.74	2.274	72.95	0.048	47.50	0.632	-33.83
900	0.768	-173.91	2.041	69.14	0.049	53.32	0.637	-36.62
1000	0.765	-176.92	1.844	65.26	0.054	58.93	0.643	-39.47

$V_{CE}=5V, I_C=10mA, Z_O=50\Omega$

Freq(MHz)	S11	$\angle S11$	S21	$\angle S21$	S12	$\angle S12$	S22	$\angle S22$
100	0.767	-103.15	15.822	124.63	0.023	46.33	0.734	-20.47
200	0.755	-138.50	9.411	104.65	0.028	38.32	0.619	-20.77
300	0.754	-153.35	6.527	94.69	0.030	38.73	0.584	-21.03
400	0.752	-161.57	4.982	87.97	0.033	42.64	0.572	-22.78
500	0.750	-166.80	4.014	82.84	0.035	48.31	0.572	-24.69
600	0.748	-170.55	3.373	78.22	0.037	54.47	0.569	-27.25
700	0.753	-173.80	2.897	73.96	0.041	59.86	0.572	-29.68
800	0.756	-176.67	2.549	69.82	0.044	62.98	0.581	-32.50
900	0.757	-179.14	2.277	66.41	0.049	68.43	0.588	-35.36
1000	0.755	-178.64	2.056	62.61	0.053	72.29	0.593	-38.13

# 15GN03FA

## S Parameters (Common emitter)

$V_{CE}=5V, I_C=15mA, Z_O=50\Omega$

Freq(MHz)	S11	$\angle S11$	S21	$\angle S21$	S12	$\angle S12$	S22	$\angle S22$
100	0.738	-117.62	17.843	118.37	0.020	37.24	0.676	-21.03
200	0.743	-147.93	10.060	100.54	0.023	37.86	0.576	-19.90
300	0.747	-159.66	6.883	91.63	0.025	46.10	0.554	-19.99
400	0.745	-166.45	5.220	85.36	0.029	50.71	0.546	-21.67
500	0.744	-170.73	4.196	80.63	0.032	56.16	0.545	-23.38
600	0.745	-173.77	3.511	76.05	0.037	61.92	0.546	-26.19
700	0.752	-176.53	3.020	72.07	0.040	66.25	0.552	-28.81
800	0.756	-179.03	2.658	68.01	0.044	70.92	0.560	-31.80
900	0.755	178.79	2.361	64.63	0.049	74.88	0.565	-34.57
1000	0.756	176.76	2.132	60.89	0.053	76.28	0.574	-37.19

$V_{CE}=5V, I_C=20mA, Z_O=50\Omega$

Freq(MHz)	S11	$\angle S11$	S21	$\angle S21$	S12	$\angle S12$	S22	$\angle S22$
100	0.726	-126.53	18.861	114.70	0.017	40.89	0.640	-21.11
200	0.739	-153.13	10.358	98.19	0.022	42.84	0.553	-18.93
300	0.745	-163.18	7.042	89.82	0.024	49.20	0.536	-19.14
400	0.745	-169.08	5.324	83.86	0.027	55.62	0.530	-20.71
500	0.745	-172.83	4.271	79.22	0.031	60.79	0.533	-22.65
600	0.746	-175.56	3.573	74.72	0.035	67.12	0.534	-25.56
700	0.753	-177.99	3.062	70.86	0.039	71.29	0.539	-28.07
800	0.756	179.89	2.695	66.61	0.043	73.72	0.550	-30.95
900	0.757	177.73	2.394	63.36	0.050	76.38	0.557	-33.79
1000	0.758	175.84	2.152	59.54	0.055	80.04	0.565	-36.64

$V_{CE}=5V, I_C=30mA, Z_O=50\Omega$

Freq(MHz)	S11	$\angle S11$	S21	$\angle S21$	S12	$\angle S12$	S22	$\angle S22$
100	0.717	-137.48	19.630	110.26	0.015	44.21	0.601	-20.34
200	0.738	-159.18	10.491	95.35	0.018	47.49	0.531	-17.41
300	0.746	-167.18	7.088	87.53	0.021	53.11	0.517	-17.66
400	0.748	-172.07	5.346	81.72	0.026	61.37	0.517	-19.37
500	0.748	-175.06	4.275	77.20	0.030	66.16	0.521	-21.62
600	0.752	-177.32	3.568	72.74	0.034	71.42	0.527	-24.47
700	0.760	-179.44	3.054	68.73	0.039	73.32	0.532	-26.91
800	0.764	178.51	2.662	64.73	0.044	78.79	0.543	-29.78
900	0.766	176.85	2.365	61.05	0.049	79.65	0.553	-32.93
1000	0.766	174.89	2.129	57.53	0.055	81.62	0.562	-35.85

$V_{CE}=5V, I_C=50mA, Z_O=50\Omega$

Freq(MHz)	S11	$\angle S11$	S21	$\angle S21$	S12	$\angle S12$	S22	$\angle S22$
100	0.726	-148.90	18.826	105.46	0.013	44.77	0.567	-18.27
200	0.751	-165.14	9.843	92.00	0.017	52.99	0.521	-15.19
300	0.762	-171.12	6.595	84.51	0.020	59.41	0.513	-16.09
400	0.764	-174.96	4.946	78.62	0.024	66.61	0.516	-18.39
500	0.767	-177.43	3.935	74.00	0.029	73.69	0.522	-20.54
600	0.772	-179.26	3.268	69.60	0.033	75.14	0.529	-23.65
700	0.780	178.77	2.784	65.39	0.038	78.53	0.537	-26.50
800	0.786	176.95	2.430	60.89	0.043	80.73	0.548	-29.67
900	0.789	175.17	2.150	57.73	0.050	83.79	0.559	-32.92
1000	0.791	173.32	1.926	53.98	0.054	84.92	0.569	-35.99

Embossed Taping Specification

15GN03FA-TL-H

1. Packing Format

Package Name	Carrier Tape Type	Maximum Number of devices contained (pcs)			Packing format	
		Reel	Inner box	Outer box	Inner BOX (C-1)	Outer BOX (A-7)
SSFP	SSFP	8,000	40,000	240,000	5 reels contained Dimensions:mm (external) 183×72×185	6 inner boxes contained Dimension::mm (external) 440×195×210

Packing method

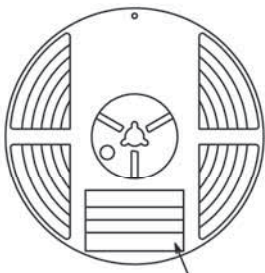

Reel label

Reel label, Inner box label  
(unit:mm)

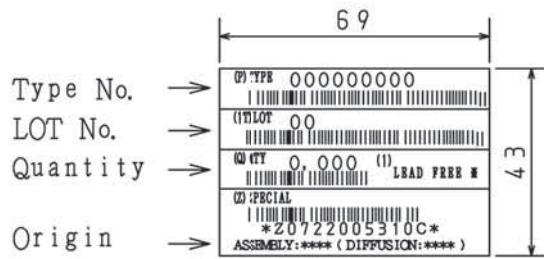

Outer box label  
It is a label at the time of factory shipments. The form of a label may change in physical distribution process.

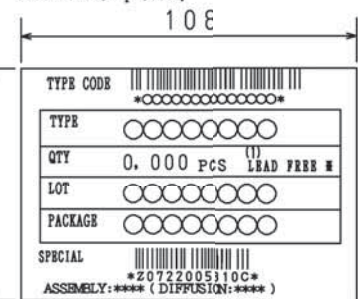

NOTE (1)

The LEAD FREE \* description shows that the surface treatment of the terminal is lead free.

Label	JEITA Phase
LEAD FREE 3	JEITA Phase 3A
LEAD FREE 4	JEITA Phase 3

2. Taping configuration

2-1. Carrier tape size (unit:mm)

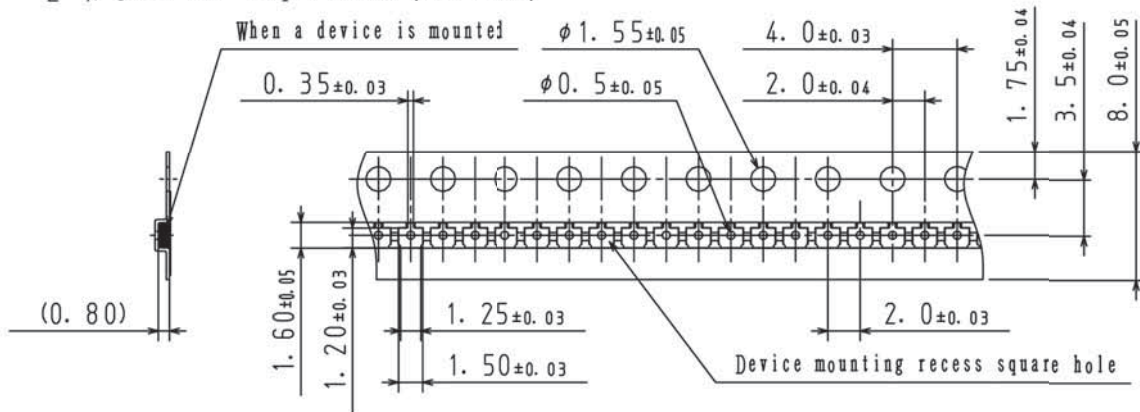

2-2. Device placement direction

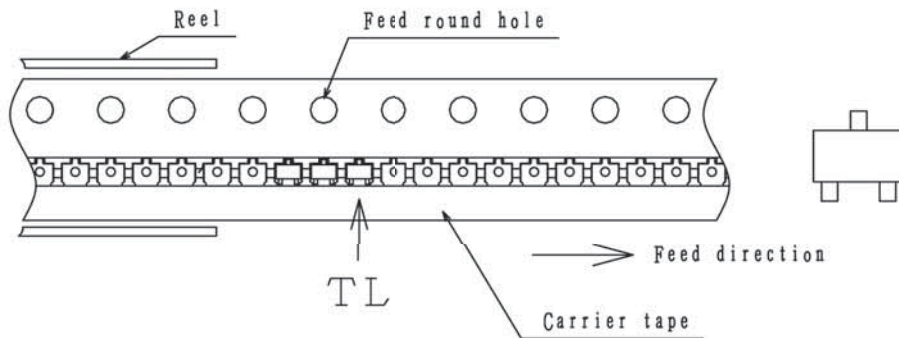

Those with pin 1 index on the feed hole side.....TL

# 15GN03FA

## Outline Drawing 15GN03FA-TL-H

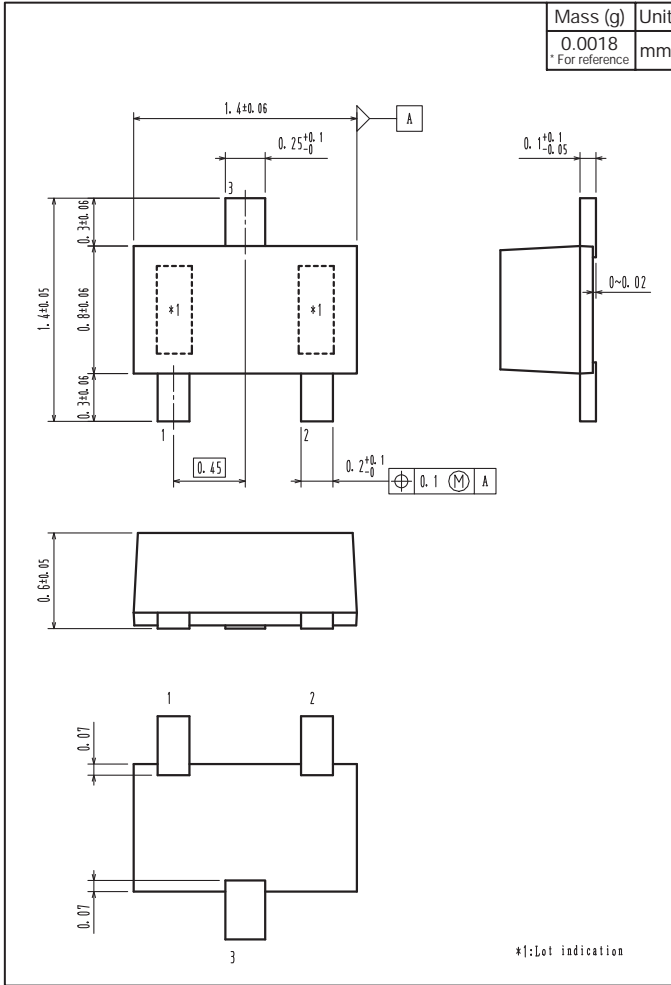

## Land Pattern Example

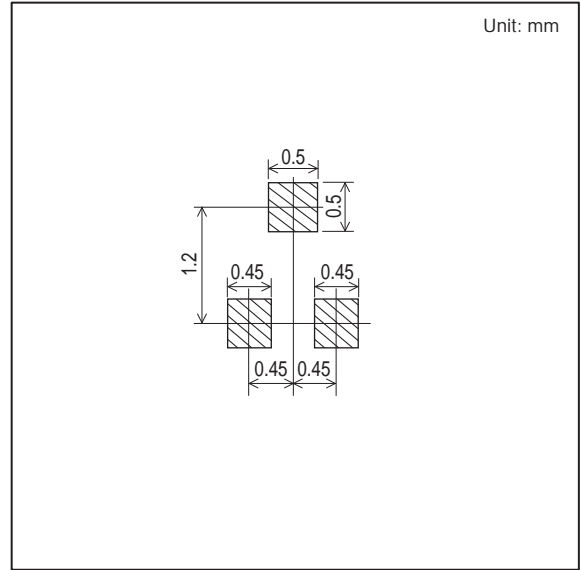

- Any and all SANYO Semiconductor Co.,Ltd. products described or contained herein are, with regard to "standard application", intended for the use as general electronics equipment. The products mentioned herein shall not be intended for use for any "special application" (medical equipment whose purpose is to sustain life, aerospace instrument, nuclear control device, burning appliances, transportation machine, traffic signal system, safety equipment etc.) that shall require extremely high level of reliability and can directly threaten human lives in case of failure or malfunction of the product or may cause harm to human bodies, nor shall they grant any guarantee thereof. If you should intend to use our products for new introduction or other application different from current conditions on the usage of automotive device, communication device, office equipment, industrial equipment etc. , please consult with us about usage condition (temperature, operation time etc.) prior to the intended use. If there is no consultation or inquiry before the intended use, our customer shall be solely responsible for the use.
- Specifications of any and all SANYO Semiconductor Co.,Ltd. products described or contained herein stipulate the performance, characteristics, and functions of the described products in the independent state, and are not guarantees of the performance, characteristics, and functions of the described products as mounted in the customer's products or equipment. To verify symptoms and states that cannot be evaluated in an independent device, the customer should always evaluate and test devices mounted in the customer's products or equipment.
- SANYO Semiconductor Co.,Ltd. assumes no responsibility for equipment failures that result from using products at values that exceed, even momentarily, rated values (such as maximum ratings, operating condition ranges, or other parameters) listed in products specifications of any and all SANYO Semiconductor Co.,Ltd. products described or contained herein.
- Regarding monolithic semiconductors, if you should intend to use this IC continuously under high temperature, high current, high voltage, or drastic temperature change, even if it is used within the range of absolute maximum ratings or operating conditions, there is a possibility of decrease reliability. Please contact us for a confirmation.
- SANYO Semiconductor Co.,Ltd. strives to supply high-quality high-reliability products, however, any and all semiconductor products fail or malfunction with some probability. It is possible that these probabilistic failures or malfunction could give rise to accidents or events that could endanger human lives, trouble that could give rise to smoke or fire, or accidents that could cause damage to other property. When designing equipment, adopt safety measures so that these kinds of accidents or events cannot occur. Such measures include but are not limited to protective circuits and error prevention circuits for safe design, redundant design, and structural design.
- In the event that any or all SANYO Semiconductor Co.,Ltd. products described or contained herein are controlled under any of applicable local export control laws and regulations, such products may require the export license from the authorities concerned in accordance with the above law.
- No part of this publication may be reproduced or transmitted in any form or by any means, electronic or mechanical, including photocopying and recording, or any information storage or retrieval system, or otherwise, without the prior written consent of SANYO Semiconductor Co.,Ltd.
- Any and all information described or contained herein are subject to change without notice due to product/technology improvement, etc. When designing equipment, refer to the "Delivery Specification" for the SANYO Semiconductor Co.,Ltd. product that you intend to use.
- Upon using the technical information or products described herein, neither warranty nor license shall be granted with regard to intellectual property rights or any other rights of SANYO Semiconductor Co.,Ltd. or any third party. SANYO Semiconductor Co.,Ltd. shall not be liable for any claim or suits with regard to a third party's intellectual property rights which has resulted from the use of the technical information and products mentioned above.

This catalog provides information as of July, 2012. Specifications and information herein are subject to change without notice.