



Website:<http://biz.LGservice.com>
E-mail:<http://www.LGService.com/techsup.html>

COLOR MONITOR

SERVICE MANUAL

CHASSIS NO. : CL-70

MODEL: FLATRON M4200C (M4200C-SAC.AH**T)
FLATRON M4200C (M4200C-SAFC.AH**T)
FLATRON M4200C (M4200C-BAC.AH**T)
FLATRON M4200C (M4200C-BATC.AH**T)
FLATRON M4200C (M4200C-BAPC.AH**T)

() **Same model for Service

CAUTION

BEFORE SERVICING THE UNIT,
READ THE **SAFETY PRECAUTIONS** IN THIS MANUAL.

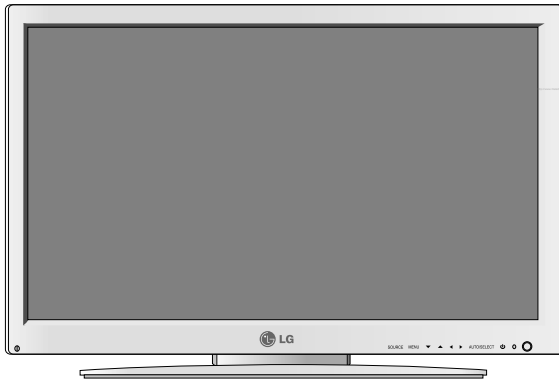

CONTENTS

SPECIFICATIONS	2	SERVICE OSD	14
PRECAUTIONS	3	TROUBLESHOOTING GUIDE	15
TIMING CHART	8	WIRING DIAGRAM	21
BLOCK DIAGRAM	10	EXPLODED VIEW.....	22
DESCRIPTION OF BLOCK DIAGRAM.....	11	REPLACEMENT PARTS LIST	24
ADJUSTMENT	12	SCHEMATIC DIAGRAM.....	35

SPECIFICATIONS

1. LCD CHARACTERISTICS

Type : TFT Color LCD Module
 Active Display Area : 42.02inches(1067.308mm)diagonal
 Pixel Pitch : 0.227mm x 0.681m x RGB
 Color Depth : 8-bit, 16,777,216 colors
 Electrical Interface : LVDS
 Size : 1006mm(H) x 610(V)x59(D)mm
 Surface Treatment : Anti-Glare, Hard Coating(3H)
 Operating Mode : Normally Black
 Backlight Unit : 20-CCFL(20 lamps)

2. OPTICAL CHARACTERISTICS

2-1. Viewing Angle by Contrast Ratio ≥ 10

Left : -85° min., -88°(Typ.) Right : +85° min., +88°(Typ.)
 Top : +85° min., +88°(Typ.) Bottom : -85° min., -88°(Typ.)

2-2. Luminance : 400(min), 500(Typ.)

2-3. Contrast Ratio : 300(min), 400(Typ.) (Without AI)
 700(min), 1000(Typ.) (With AI)

3. SIGNAL (Refer to the Timing Chart)

3-1. PC & Video Input

- 1)Signal Input : S-video,RCA, Component, AV(CVBS)
- 2)Input Form : D-SUB Analog, DVI, V1(CVBS)
 Component1(YCbCr),Component2(YPbPr),
 TV(NTSC)
- 3)Resolution(max) : Analog - 1600 x 1200@60Hz
 Digital - 1280 x 1024@60Hz

3-2. Sync Input

- Horizontal : 30 ~ 83kHz(Digital: 30~72kHz)
- Vertical : 56 ~ 85Hz
- Input Form : Separate, TTL,
 Positive/Negative Digital

4. SPECIAL FUNCTION

4-1. Audio

- 1)Output Rating: 10W + 10W(Rated Output $\pm 10\%$)
- 2)Freq. Character : 100Hz~10KHz Range(-3dB)
- 3)T. H. D : Within 10%
- 4)Input Sensitivity: 0.700Vrms

4-2. Speaker

- 1)TYPE : Detachable
- 2)Impedance : 8 Ω
- 3)Input : Max : 15W, Normal : 10W

4-2. AV

- 1)Video Level : Input : 0.7 \pm 0.15Vp-p
- 2)Sync Level : Input : 0.286 \pm 0.075Vp-p
- 3)Color Burst : Input : 0.214 \pm 0.072Vp-p
- 4)Audio Level : NTSC Input : 0.40 \pm 0.1Vrms
 PAL Input : 0.5 \pm 0.1Vrms
 PC Input : 0.7 \pm 0.1Vrms
- 5)Video Cross Talk : 43dB

5. POWER SUPPLY

5-1. Power Adaptor

Input : AC 100~240V, 50/60Hz , 2.8A

5-2. Power Consumption

MODE	H/V SYNC	VIDEO	POWER CONSUMPTION	LED COLOR
POWER ON (NORMAL)	ON/ON	ACTIVE	less than 260 W	GREEN
STAND-BY	OFF/ON	OFF	less than 4 W	AMBER
SUSPEND	ON/OFF	OFF	less than 4 W	AMBER
DPMS OFF	OFF/OFF	OFF	less than 4 W	AMBER
POWER OFF	-	-	less than 2 W	-

6. ENVIRONMENT

- 6-1. Operating Temperature : 10°C~35°C
- 6-2. Operating Humidity : 10%~80%
- 6-3. MTBF : 50,000 HRS with 90% Confidence level
 Lamp Life : 50,000 Hours (min)

7. DIMENSIONS

M4200C-SAC/M4200C-BAC (without Speaker/Stand)

Width : 1057mm (41.61")
 Depth : 119.1 mm (4.69")
 Height : 653 mm (25.71")

M4200C-BAPC (without Stand)

Width : 1259mm (49.57")
 Depth : 119.1 mm (4.69")
 Height : 653 mm (25.71")

M4200C-BATC (without Speaker)

Width : 1057 mm (41.61")
 Depth : 294.5 mm (11.59")
 Height : 702 mm (27.64")

M4200C-SAFC

Width : 1259 mm (49.57")
 Depth : 294.5 mm (11.59")
 Height : 702 mm (27.64")

8. WEIGHT

M4200C-SAC/M4200C-BAC (without Speaker/Stand)

Net. Weight : 30.8 kg (67.91 lbs)

Gross Weight : 37.3 kg (82.24 lbs)

M4200C-BAPC (without Stand)

Net. Weight : 33.6 kg (74.09 lbs)

Gross Weight : 40.1 kg (88.42 lbs)

M4200C-BATC (without Speaker)

Net. Weight : 37.2 kg (82.02 lbs)

Gross Weight : 43.7 kg (96.36 lbs)

M4200C-SAFC

Net. Weight : 40.0 kg (88.20 lbs)

Gross Weight : 46.5 kg (102.53 lbs)

PRECAUTION

WARNING FOR THE SAFETY-RELATED COMPONENT.

- There are some special components used in LCD monitor that are important for safety. **These parts are marked \triangle on the schematic diagram and the replacement parts list.** It is essential that these critical parts should be replaced with the manufacturer's specified parts to prevent electric shock, fire or other hazard.
- Do not modify original design without obtaining written permission from manufacturer or you will void the original parts and labor guarantee.

TAKE CARE DURING HANDLING THE LCD MODULE WITH BACKLIGHT UNIT.

- Must mount the module using mounting holes arranged in four corners.
- Do not press on the panel, edge of the frame strongly or electric shock as this will result in damage to the screen.
- Do not scratch or press on the panel with any sharp objects, such as pencil or pen as this may result in damage to the panel.
- Protect the module from the ESD as it may damage the electronic circuit (C-MOS).
- Make certain that treatment person's body are grounded through wrist band.
- Do not leave the module in high temperature and in areas of high humidity for a long time.
- The module not be exposed to the direct sunlight.
- Avoid contact with water as it may a short circuit within the module.
- If the surface of panel become dirty, please wipe it off with a softmaterial. (Cleaning with a dirty or rough cloth may damage the panel.)

\triangle CAUTION

Please use only a plastic screwdriver to protect yourself from shock hazard during service operation.

\triangle WARNING

BE CAREFUL ELECTRIC SHOCK !

- If you want to replace with the new backlight (CCFL) or inverter circuit, must disconnect the AC adapter because high voltage appears at inverter circuit about 650Vrms.
- Handle with care wires or connectors of the inverter circuit. If the wires are pressed cause short and may burn or take fire.

Leakage Current Hot Check Circuit

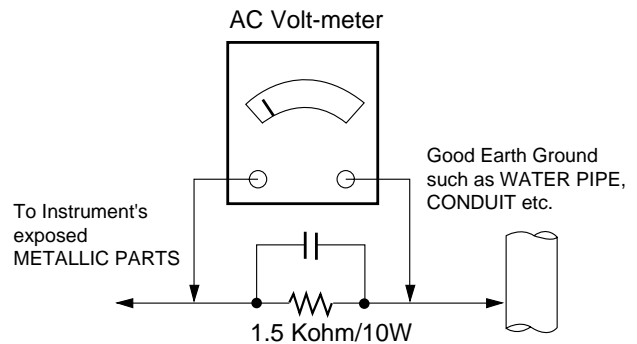

SERVICING PRECAUTIONS

CAUTION: Before servicing receivers covered by this service manual and its supplements and addenda, read and follow the **SAFETY PRECAUTIONS** on page 3 of this publication.

NOTE: If unforeseen circumstances create conflict between the following servicing precautions and any of the safety precautions on page 3 of this publication, always follow the safety precautions. Remember: Safety First.

General Servicing Precautions

1. Always unplug the receiver AC power cord from the AC power source before;
 - a. Removing or reinstalling any component, circuit board module or any other receiver assembly.
 - b. Disconnecting or reconnecting any receiver electrical plug or other electrical connection.
 - c. Connecting a test substitute in parallel with an electrolytic capacitor in the receiver.

CAUTION: A wrong part substitution or incorrect polarity installation of electrolytic capacitors may result in an explosion hazard.

- d. Discharging the picture tube anode.
2. Test high voltage only by measuring it with an appropriate high voltage meter or other voltage measuring device (DVM, FETVOM, etc) equipped with a suitable high voltage probe.
Do not test high voltage by "drawing an arc".
 3. Discharge the picture tube anode only by (a) first connecting one end of an insulated clip lead to the degaussing or kine aquadag grounding system shield at the point where the picture tube socket ground lead is connected, and then (b) touch the other end of the insulated clip lead to the picture tube anode button, using an insulating handle to avoid personal contact with high voltage.
 4. Do not spray chemicals on or near this receiver or any of its assemblies.
 5. Unless specified otherwise in this service manual, clean electrical contacts only by applying the following mixture to the contacts with a pipe cleaner, cotton-tipped stick or comparable non-abrasive applicator; 10% (by volume) Acetone and 90% (by volume) isopropyl alcohol (90%-99% strength)

CAUTION: This is a flammable mixture.

Unless specified otherwise in this service manual, lubrication of contacts is not required.

6. Do not defeat any plug/socket B+ voltage interlocks with which receivers covered by this service manual might be equipped.
7. Do not apply AC power to this instrument and/or any of its electrical assemblies unless all solid-state device heat sinks are correctly installed.
8. Always connect the test receiver ground lead to the receiver chassis ground before connecting the test receiver positive lead.

Always remove the test receiver ground lead last.

9. Use with this receiver only the test fixtures specified in this service manual.

CAUTION: Do not connect the test fixture ground strap to any heat sink in this receiver.

Electrostatically Sensitive (ES) Devices

Some semiconductor (solid-state) devices can be damaged easily by static electricity. Such components commonly are called *Electrostatically Sensitive (ES) Devices*. Examples of typical ES devices are integrated circuits and some field-effect transistors and semiconductor "chip" components. The following techniques should be used to help reduce the incidence of component damage caused by static by static electricity.

1. Immediately before handling any semiconductor component or semiconductor-equipped assembly, drain off any electrostatic charge on your body by touching a known earth ground. Alternatively, obtain and wear a commercially available discharging wrist strap device, which should be removed to prevent potential shock reasons prior to applying power to the unit under test.
2. After removing an electrical assembly equipped with ES devices, place the assembly on a conductive surface such as aluminum foil, to prevent electrostatic charge buildup or exposure of the assembly.
3. Use only a grounded-tip soldering iron to solder or unsolder ES devices.
4. Use only an anti-static type solder removal device. —Some solder removal devices not classified as "anti-static" can generate electrical charges sufficient to damage ES devices.
5. Do not use freon-propelled chemicals. These can generate electrical charges sufficient to damage ES devices.
6. Do not remove a replacement ES device from its protective package until immediately before you are ready to install it. (Most replacement ES devices are packaged with leads electrically shorted together by conductive foam, aluminum foil or comparable conductive material).
7. Immediately before removing the protective material from the leads of a replacement ES device, touch the protective material to the chassis or circuit assembly into which the device will be installed.

CAUTION: Be sure no power is applied to the chassis or circuit, and observe all other safety precautions.

8. Minimize bodily motions when handling unpackaged replacement ES devices. (Otherwise harmless motion such as the brushing together of your clothes fabric or the lifting of your foot from a carpeted floor can generate static electricity sufficient to damage an ES device.)

General Soldering Guidelines

1. Use a grounded-tip, low-wattage soldering iron and appropriate tip size and shape that will maintain tip temperature within the range of 500° F to 600° F.
2. Use an appropriate gauge of RMA resin-core solder composed of 60 parts tin/40 parts lead.
3. Keep the soldering iron tip clean and well tinned.
4. Thoroughly clean the surfaces to be soldered. Use a small wire-bristle (0.5 inch, or 1.25cm) brush with a metal handle.

Do not use freon-propelled spray-on cleaners.

5. Use the following unsoldering technique
 - a. Allow the soldering iron tip to reach normal temperature.
(500° F to 600° F)
 - b. Heat the component lead until the solder melts.
 - c. Quickly draw the melted solder with an anti-static, suction-type solder removal device or with solder braid.
6. Use the following soldering technique.
 - a. Allow the soldering iron tip to reach a normal temperature (500° F to 600° F)
 - b. First, hold the soldering iron tip and solder the strand against the component lead until the solder melts.

- c. Quickly move the soldering iron tip to the junction of the component lead and the printed circuit foil, and hold it there only until the solder flows onto and around both the component lead and the foil.

CAUTION: Work quickly to avoid overheating the circuit board printed foil.

- d. Closely inspect the solder area and remove any excess or splashed solder with a small wire-bristle brush.

IC Remove/Replacement

Some chassis circuit boards have slotted holes (oblong) through which the IC leads are inserted and then bent flat against the circuit foil. When holes are the slotted type, the following technique should be used to remove and replace the IC. When working with boards using the familiar round hole, use the standard technique as outlined in paragraphs 5 and 6 above.

Removal

1. Desolder and straighten each IC lead in one operation by gently prying up on the lead with the soldering iron tip as the solder melts.
2. Draw away the melted solder with an anti-static suction-type solder removal device (or with solder braid) before removing the IC.

Replacement

1. Carefully insert the replacement IC in the circuit board.
2. Carefully bend each IC lead against the circuit foil pad and solder it.
3. Clean the soldered areas with a small wire-bristle brush. (It is not necessary to reapply acrylic coating to the areas).

"Small-Signal" Discrete Transistor

Removal/Replacement

1. Remove the defective transistor by clipping its leads as close as possible to the component body.
2. Bend into a "U" shape the end of each of three leads remaining on the circuit board.
3. Bend into a "U" shape the replacement transistor leads.
4. Connect the replacement transistor leads to the corresponding leads extending from the circuit board and crimp the "U" with long nose pliers to insure metal to metal contact then solder each connection.

Power Output, Transistor Device

Removal/Replacement

1. Heat and remove all solder from around the transistor leads.
2. Remove the heat sink mounting screw (if so equipped).
3. Carefully remove the transistor from the heat sink of the circuit board.
4. Insert new transistor in the circuit board.
5. Solder each transistor lead, and clip off excess lead.
6. Replace heat sink.

Diode Removal/Replacement

1. Remove defective diode by clipping its leads as close as possible to diode body.
2. Bend the two remaining leads perpendicular y to the circuit board.
3. Observing diode polarity, wrap each lead of the new diode around the corresponding lead on the circuit board.
4. Securely crimp each connection and solder it.
5. Inspect (on the circuit board copper side) the solder joints of the two "original" leads. If they are not shiny, reheat them and if necessary, apply additional solder.

Fuse and Conventional Resistor

Removal/Replacement

1. Clip each fuse or resistor lead at top of the circuit board hollow stake.
2. Securely crimp the leads of replacement component around notch at stake top.
3. Solder the connections.

CAUTION: Maintain original spacing between the replaced component and adjacent components and the circuit board to prevent excessive component temperatures.

Circuit Board Foil Repair

Excessive heat applied to the copper foil of any printed circuit board will weaken the adhesive that bonds the foil to the circuit board causing the foil to separate from or "lift-off" the board. The following guidelines and procedures should be followed whenever this condition is encountered.

At IC Connections

To repair a defective copper pattern at IC connections use the following procedure to install a jumper wire on the copper pattern side of the circuit board. (Use this technique only on IC connections).

1. Carefully remove the damaged copper pattern with a sharp knife. (Remove only as much copper as absolutely necessary).
2. Carefully scratch away the solder resist and acrylic coating (if used) from the end of the remaining copper pattern.
3. Bend a small "U" in one end of a small gauge jumper wire and carefully crimp it around the IC pin. Solder the IC connection.
4. Route the jumper wire along the path of the out-away copper pattern and let it overlap the previously scraped end of the good copper pattern. Solder the overlapped area and clip off any excess jumper wire.

At Other Connections

Use the following technique to repair the defective copper pattern at connections other than IC Pins. This technique involves the installation of a jumper wire on the component side of the circuit board.

1. Remove the defective copper pattern with a sharp knife.
Remove at least 1/4 inch of copper, to ensure that a hazardous condition will not exist if the jumper wire opens.
2. Trace along the copper pattern from both sides of the pattern break and locate the nearest component that is directly connected to the affected copper pattern.
3. Connect insulated 20-gauge jumper wire from the lead of the nearest component on one side of the pattern break to the lead of the nearest component on the other side.

Carefully crimp and solder the connections.

CAUTION: Be sure the insulated jumper wire is dressed so the it does not touch components or sharp edges.

TIMING CHART

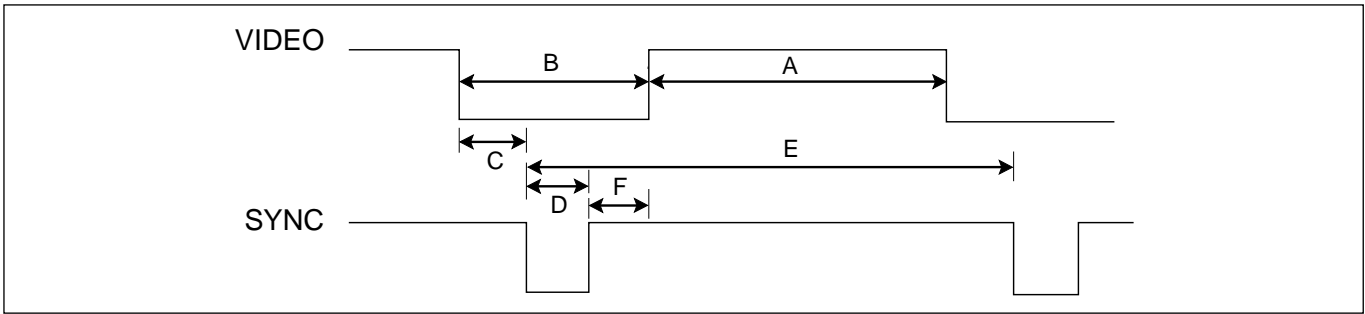

<< Dot Clock (MHz), Horizontal Frequency (kHz), Vertical Frequency (Hz), Horizontal etc... (μs), Vertical etc... (ms) >>

1) PC Mode

MODE	H / V	Sync Polarity	Dot Clock	Frequency	Total Period (E)	Video Active Time (A)	Front Porch (C)	Sync Duration (D)	Back Porch (F)	Resolution
1	H(Pixels)	+	25.175	31.469	800	640	16	96	48	640 x 350
	V(Lines)	-		70.8						
2	H(Pixels)	-	28.321	31.468	900	720	18	108	54	720 X 400
	V(Lines)	+		70.8						
3	H(Pixels)	-	25.175	31.469	800	640	16	96	48	640 x 480
	V(Lines)	-		59.94						
4	H(Pixels)	-	31.5	37.5	840	640	16	64	120	640 x 480
	V(Lines)	-		75						
5	H(Pixels)	-	36.0	43.269	832	640	56	56	80	640 x 480
	V(Lines)	-		85.0						
6	H(Pixels)	+	40.0	37.879	1056	800	40	128	88	800 x 600
	V(Lines)	+		60.317						
7	H(Pixels)	+	49.5	46.875	1056	800	16	80	160	800 x 600
	V(Lines)	+		75.0						
8	H(Pixels)	+	56.25	53.674	1048	800	32	64	152	800 x 600
	V(Lines)	+		85.061						
9	H(Pixels)	+/-	57.283	49.725	1152	832	32	64	224	832 x 624
	V(Lines)	+/-		74.55						
10	H(Pixels)	-	65.0	48.363	1344	1024	24	136	160	1024 x 768
	V(Lines)	-		60.0						
11	H(Pixels)	-	78.75	60.123	1312	1024	16	96	176	1024 x 768
	V(Lines)	-		75.029						
12	H(Pixels)	+	94.5	68.68	1376	1024	48	96	208	1024 x 768
	V(Lines)	+		85.00						
13	H(Pixels)	+	74.5	44.772	1664	1280	64	128	192	1280 x 720
	V(Lines)	+		59.855						
14	H(Pixels)	+	84.75	47.72	1776	1360	72	136	208	1360 x 768
	V(Lines)	+		59.799						
15	H(Pixels)	+	108.0	63.981	1688	1280	48	112	248	1280 x 1024
	V(Lines)	+		60.02						
16	H(Pixels)	+	135.00	79.98	1688	1280	16	144	248	1280 x 1024
	V(Lines)	+		75.02						
17	H(Pixels)	+	162.00	75.00	2160	1600	90	30	88	1600 x 1200
	V(Lines)	+		60						

※ 1~17 : D-SUB, 1~16 : DVI-D: 1~15

2) Component Video Mode(Y/Pb/Pr)

MODE	H / V	Sync Polarity	Dot Clock	Frequency	Total Period (E)	Video Active Time (A)	Front Porch (C)	Sync Duration (D)	Back Porch (F)	Resolution
1	H(Pixels)	-	25.175	31.469	800	640	16	96	48	SDTV
	V(Lines)	-		59.94	525	480	10	2	33	480P
2	H(Pixels)	-	27.027	31.5	858	720	16	62	60	HDTV
	V(Lines)	-		60	525	480	10	2	33	720P (HDCP)
3	H(Pixels)	-	74.176	44.955	1650	1280	70	40	260	HDTV
	V(Lines)	-		59.94	750	720	5	5	60	720P (HDCP)
4	H(Pixels)	-	74.250	33.750	2200	1920	44	44	192	HDTV
	V(Lines)	-		60.053	562	540	2	5	15	1080I (HDCP)
5	H(Pixels)	-	74.176	33.716	2200	1920	44	44	192	HDTV
	V(Lines)	-		59.994	562	540	2	5	15	1080I (HDCP)

BLOCK DIAGRAM(uPD64011+gm1501H)

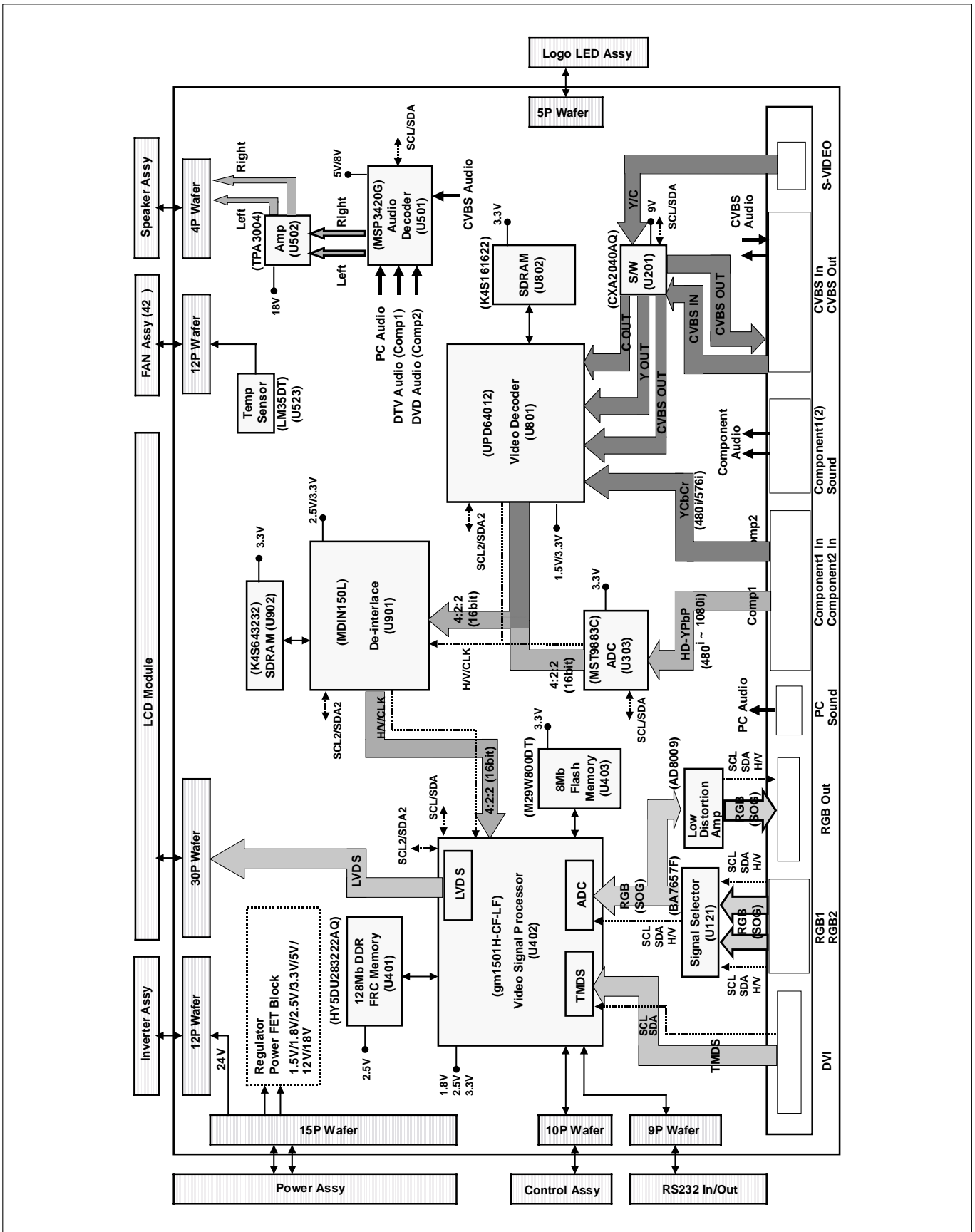

DESCRIPTION OF BLOCK DIAGRAM

1. INPUT SELECTION CIRCUIT

- 1) D-SUB RGB INPUT SELECT : This section is composed of Signal selector IC(BA7657F_U121) and peripheral devices.
The BA7657F(U121) IC select RGB1 signal or RGB2 signal and the signal is sent to gm1501H(U402).
- 2) VIDEO INPUT SELECT : This section is composed of Video switching IC(CXA2040AQ_U201) and peripheral devices.
Video switching IC(CXA2040AQ_U201) select CVBS video or S-video and the signal is sent to Video decoder (UPD64012)
- 3) DVI signal input is directly fed to SCALER, DTV(Component1) signal input is given to Scaler IC(U402) via MST9883C(U303).
DVD(Component2) signal input is given to Scaler IC via Video Decoder IC(UPD64012_U801).

2. DDC COTROLLER

This section is composed gm1501H(U402),EEPROM IC (U404, U115, U120) and peripheral devices.
gm1501H(U402) is controlling peripheral devices through IIC Line.

Major functions of this block are :

- (1) Controlling of u-COM and Flash memory through DDC-SCLA, DDC-SDAA of D-sub connector.
- (2) Storage of EDID DATA in the EEPROM(U115, U120).

3. ANALOG DIGITAL CONVERTER

This section is composed of MST9883C(U303) and peripheral devices.
gm1501H(U402) is controlling MST9883C through IIC Line.

This IC is converting DTV(YPbPr) signal in to 16 bit Interlace signal and the signal is sent to De-interlace IC(MDIN150L_U901)

This output signal have CONTRAST, BRIHTNESS, SHARPNESS, COLOR, TINT information.

3. VIDEO DECODER

This section is composed of UPD64012(U801) and peripheral devices.
gm1501H(U402) is controlling UPD64012 through IIC Line.
This IC is controlling CVBS input signal, S-VIDEO(Y/C) input signal and DVD(YCbCr) input signal.
and converting input signals in to 16 bit interlace signal and the signal is sent to De-interlace IC(U901).
This output signal have CONTRAST, BRIHTNESS, SHARPNESS, COLOR, TINT information.

4. DE-INTERLACER

This section is composed of MDIN150L(U901) and peripheral devices.
gm1501H(U402) is controlling MDIN150L through IIC Line.
This IC is converting 16bit interlace input signal in to 16bit De-interlace signal and the signal is sent to Video Signal Processor IC(gm1501H_U402).Ä

5. AUDIO DECODER

This section is composed of MSP3420G(U501) and peripheral devices.
gm1501H(U402) is controlling MSP3420G through IIC Line.

This IC is processing audio signal output of A/V Jack, PC Audio Jack.

This IC's output signal is sent to Audio Amplifier IC (TPA3004_U502).

6. AUDIO AMPLIFIER

This section is composed of TPA3004(U502) OR TPA3001(U507) and peripheral devices.
Audio Amplifier's function is amplification of sound signal received from Audio Decoder.
Input Audio signal is amplified according to the DC Volume control curve.

7. VIDEO SIGNAL PROCESSOR (FORMAT CONVERTER)

This section is composed of gm1501H(U402) and peripheral devices.

gm1501H(SCALER_U402) have in built u-COM in IC.

- (1) This IC include A/D Converter, Pre-Amp, PLL Circuit.
- (2) This IC include TMDS Receiver and LVDS Transmitter.
TMDS Receiver is decoding input DVI Signal and LVDS Transmitter is encoding the output Signal .
also, gm1501H have Format Converter (Scaling) function.
This IC convert Various sized Digital signal to LCD Module's resolution (WXGA).

8. DC/DC COVERTER

DC/DC Converters change Power output voltage (DC 5V, 12V, 24V) to 1.5V, 2.5V, 3.3V, 5V, 8V, 9V.
(To be used by different IC on the main board.)

9. TEMPERATURE SENSING AND FAN CONTROL

This section is composed of LM35DT(U523), KIA358F(U524) and peripheral devices.
The temperature at surface of LM35DT(U523) is sensed and converted to HEX code by KIA358(U524).
gm1501H(U402) receives sensing HEX values from KIA358F(U524)and control FAN(42INCH ONLY).

10. POWER SUPPLY BLOCK

Power supply receives AC voltage (100-240 V, 50/60 Hz,) and converts to System voltage that are 5V, 12V, 18V and 24V DC voltage.

These voltages supports main board, inverter board and module;s T-con board.

This Circuit contains PFC(Power Factor Correction) circuit.

The Minimum Power efficiency is about 75%.

ADJUSTMENT

All adjustment are thoroughly checked and corrected when the monitor leaves the factory, but sometimes several minor adjustment may be required. Adjustment should be following procedure and after warming up for a minimum of 30 minutes.

- Alignment appliances and tools.
 - IBM compatible PC
 - Programmable Signal Generator. (eg. VG-819 made by Astrodesign Co.)
 - Oscilloscope.
 - White Balance Meter. (CA-110)

1. DDC Data Write Procedure-Analog

- 1) Use this procedure only when there is some problem on Analog EDID data.
- 2) Run alignment program for M4200C on the IBM compatible PC.
- 3) Select EEPROM → Analog EDID write command and Enter.
- 4) This will write the Analog EDID data to EEPROM.

2. DDC Data Write Procedure-Digital

- 1) Use this procedure only when there is some problem on Digital EDID data.
- 2) Run alignment program for M4200C on the IBM compatible PC.
- 3) Select EEPROM → Digital EDID write command and Enter.
- 4) This will write the Digital EDID data to EEPROM.

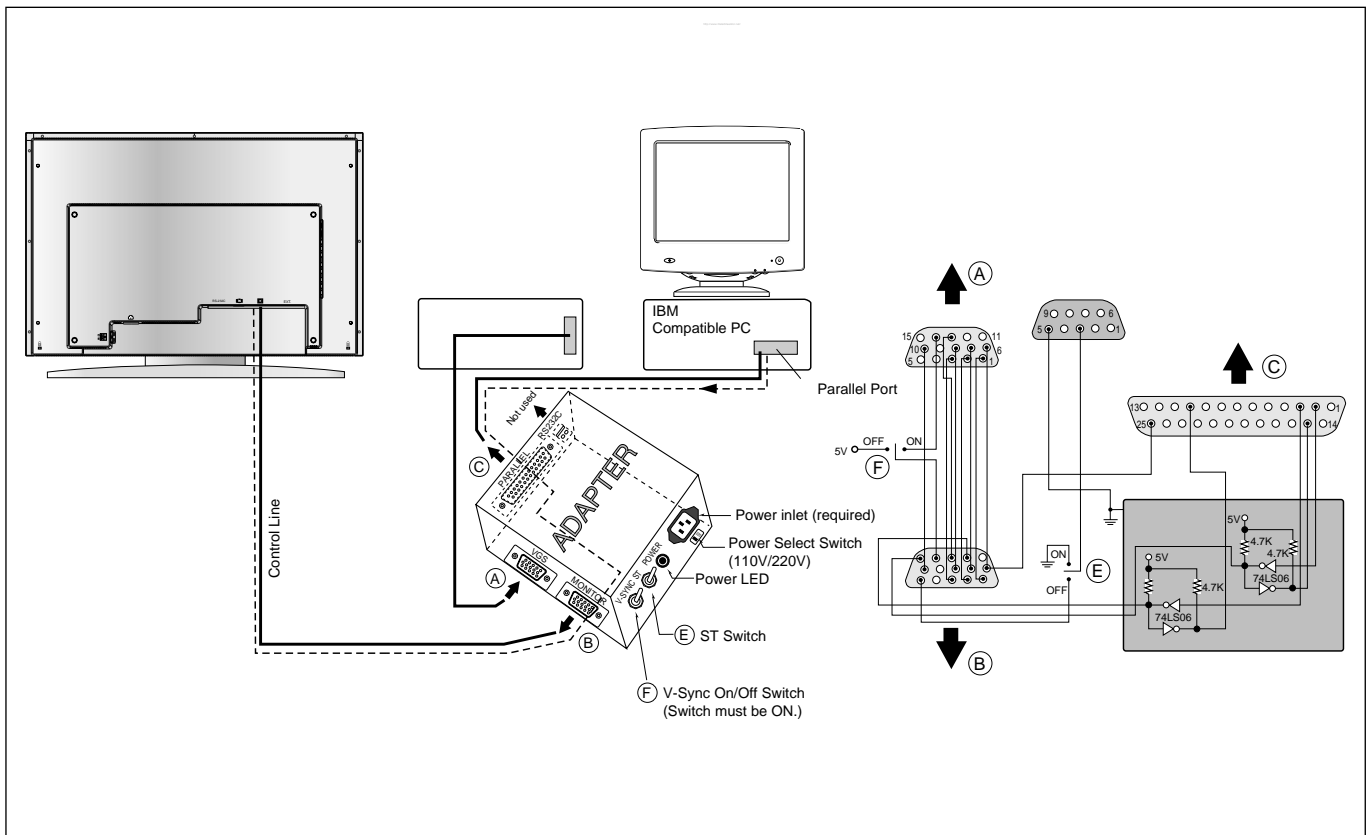

Figure 1. Cable Connection

Windows EDID V1.0 User Manual

Operating System: MS Windows 98, 2000, XP
 Port Setup: Windows 98 => Don't need setup
 Windows 2000, XP => Need to Port Setup.
 This program is available to LCD Monitor only.

1. Port Setup

- a) Copy "UserPort.sys" file to "c:\WINNT\system32\drivers" folder
- b) Run Userport.exe

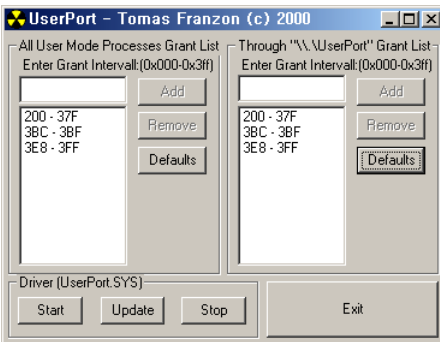

- c) Remove all default number
- d) Add 300-3FF

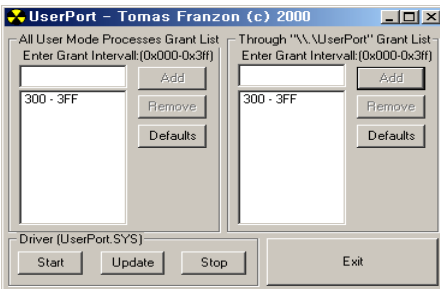

- e) Click Start button.
- f) Click Exit button.

2. EDID Read & Write

1) Run WinEDID.exe

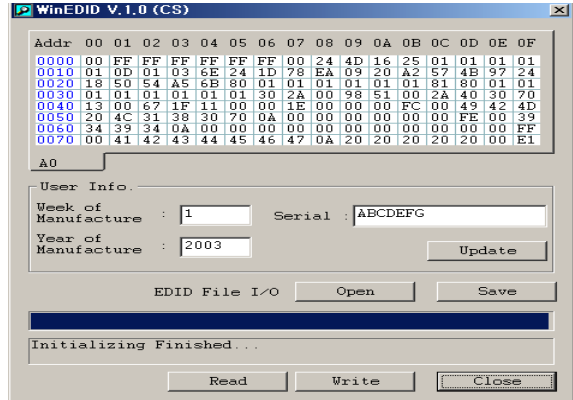

2) Edit Week of Manufacture, Year of Manufacture, Serial Number

- a) Input User Info Data
- b) Click "Update" button
- c) Click "Write" button

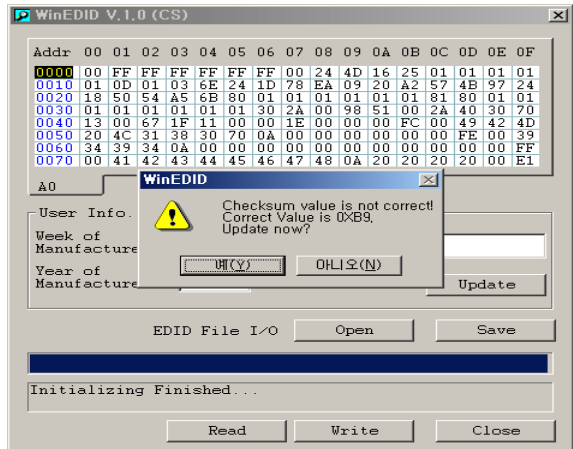

SERVICE OSD



- Engaging the `in-start' key of the remote control lets you into the Service Menu

■ Description of operation

- **Elapsed time** : Time used for back light
- **Nvram Initial** : EEPROM reset
- **RS232 Speed** : Baud Speed
- **WB Adjust** : Adjusts the white balance
- **Aging Mode** : Sets the aging mode
- **Model Select** : Sets the model name
- **TV <-> AV** : Sets the TV or AV only Model
- **Country Option** : Chooses a country

■ Caution

- To use the functions of the existing Special Menu, use Power Off/On.

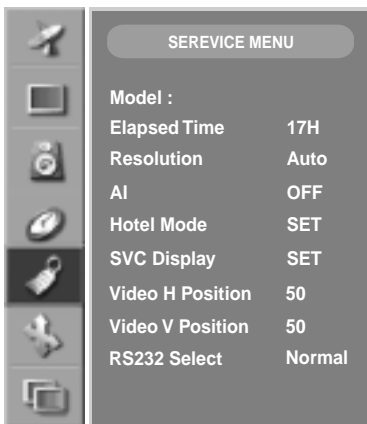

■ Description of operation

- **Resolution** : Adjusts the picture resolution
- **AI** : Function built in panel
- **Hotel Mode** : Function for a Hotel system manager
- **SVC Display** : Adjusts the service screen quality
- **Video H Position** : Adjusts Video H position
- **Video V Position** : Adjusts Video V position
- **RS232 Select** : Adjusts RS232 communication type.

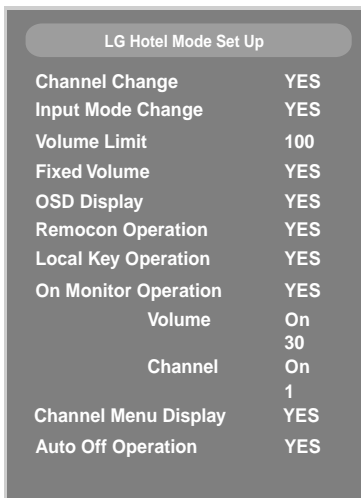

- The OSD is displayed when Audio Key is pressed on Nvram Initial in Service Menu.

■ Purpose

- **Function** : The setting can be adjusted when the unit is being used in a hotel.

■ Description of operation

- **Channel Change** : Enables (Yes)/Disables (No) channel change in the TV source mode.
- **Input Source Change** : Enables (Yes)/Disables (No) input source change.
- **Volume Limit** : Sets the maximum volume within the range of 0 ~ 100 when volume control is allowed.
- **Fixed Volume** : Sets Yes (Fixed)/No (Variable) about whether the sound volume will be fixed to the current value or not.
- **OSD Display** : Sets whether the OSD will be displayed (Yes) or not (No).
- **Remote Control Operation** : Activates (Yes)/Deactivates (No) remote control operation.
- **Local Key Operation** : Activates (Yes)/Deactivates (No) local key operation.
- **On Monitor Operation** : Sets Yes (Operation)/No (No operation) about whether the channel and the volume level that will be displayed when the power is turned on.
- **Channel** : Sets Yes (Operation)/No (No operation) about whether the preset channel will be selected or the one memorized last will be selected when the power is turned on. On (Activated) or Off (Deactivated) can be selected.
- **Channel Menu Display** : Enables (Yes)/Disables (No) entry into the Channel menu on the main OSD.
- **Auto Off Operation** : Sets whether the automatic turn-off function will be activated or not with On (Activated) or Off (Deactivated) option, which turns off the TV if no key input is made for 2 hours, using Auto Off operation and On Time on the Time menu.

TROUBLESHOOTING GUIDE

1. NO POWER

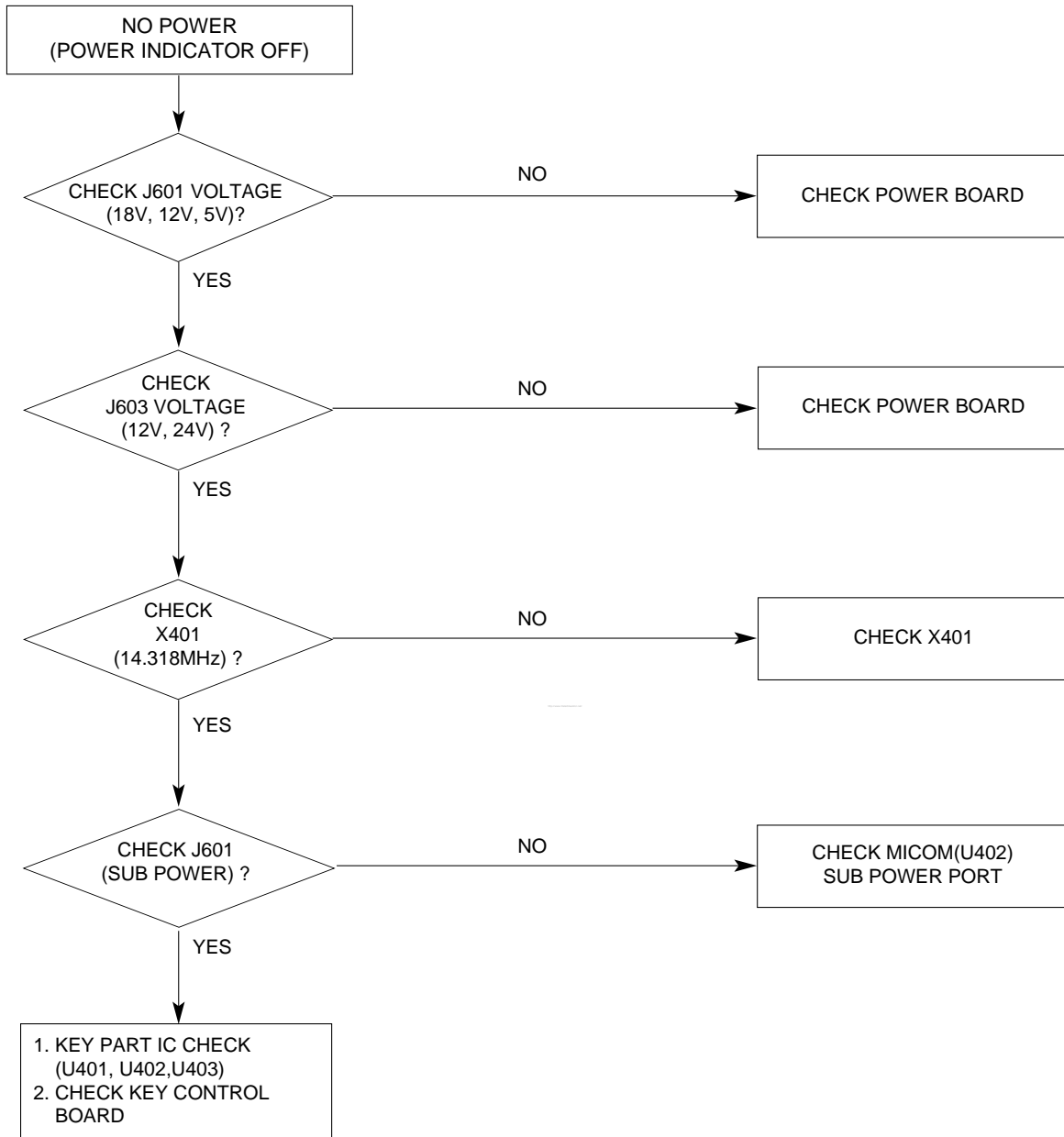

2. NO RASTER(OSD IS NOT DISPLAYED)

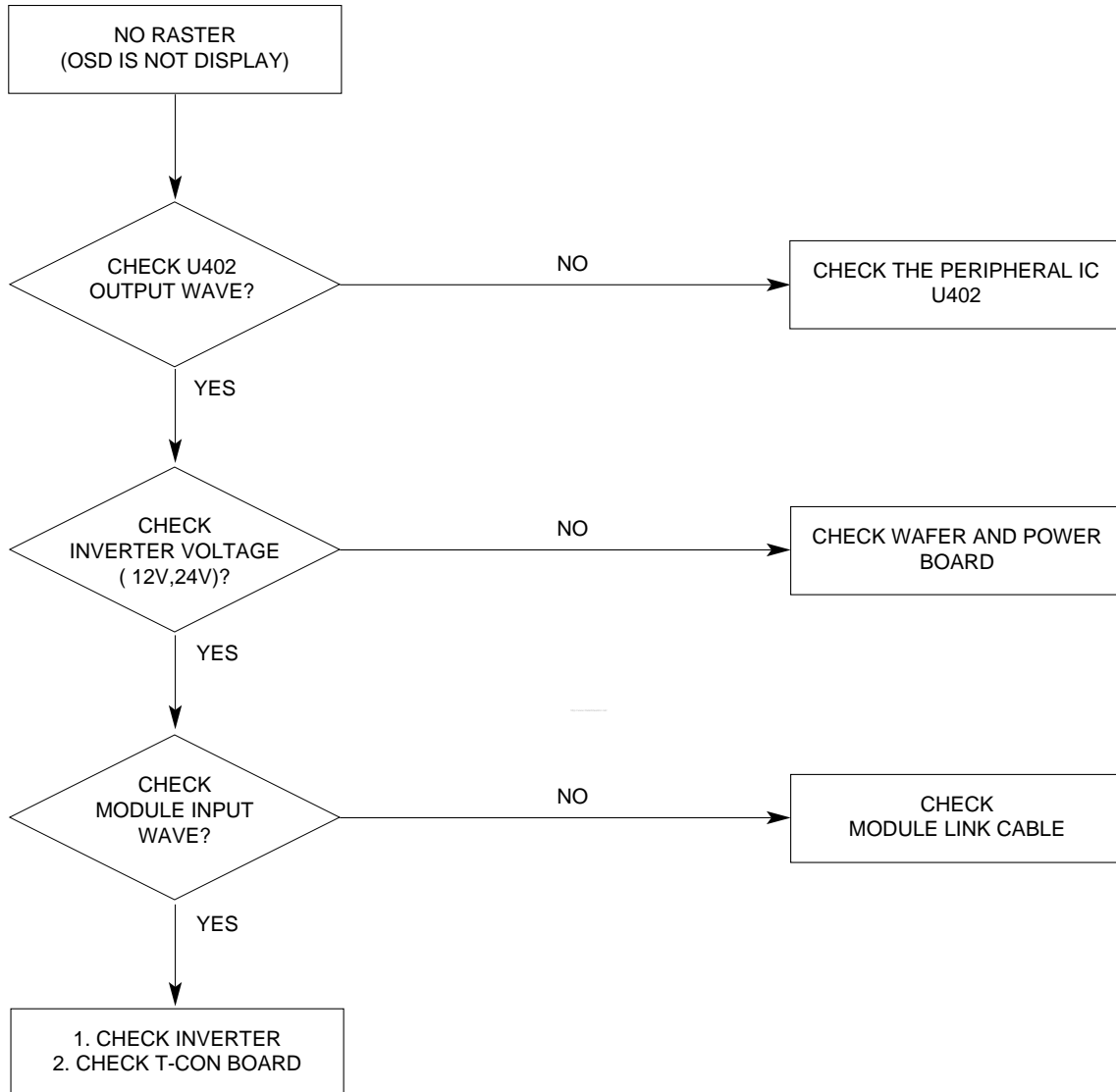

3. NO RASTER STATE ON VIDEO SIGNAL

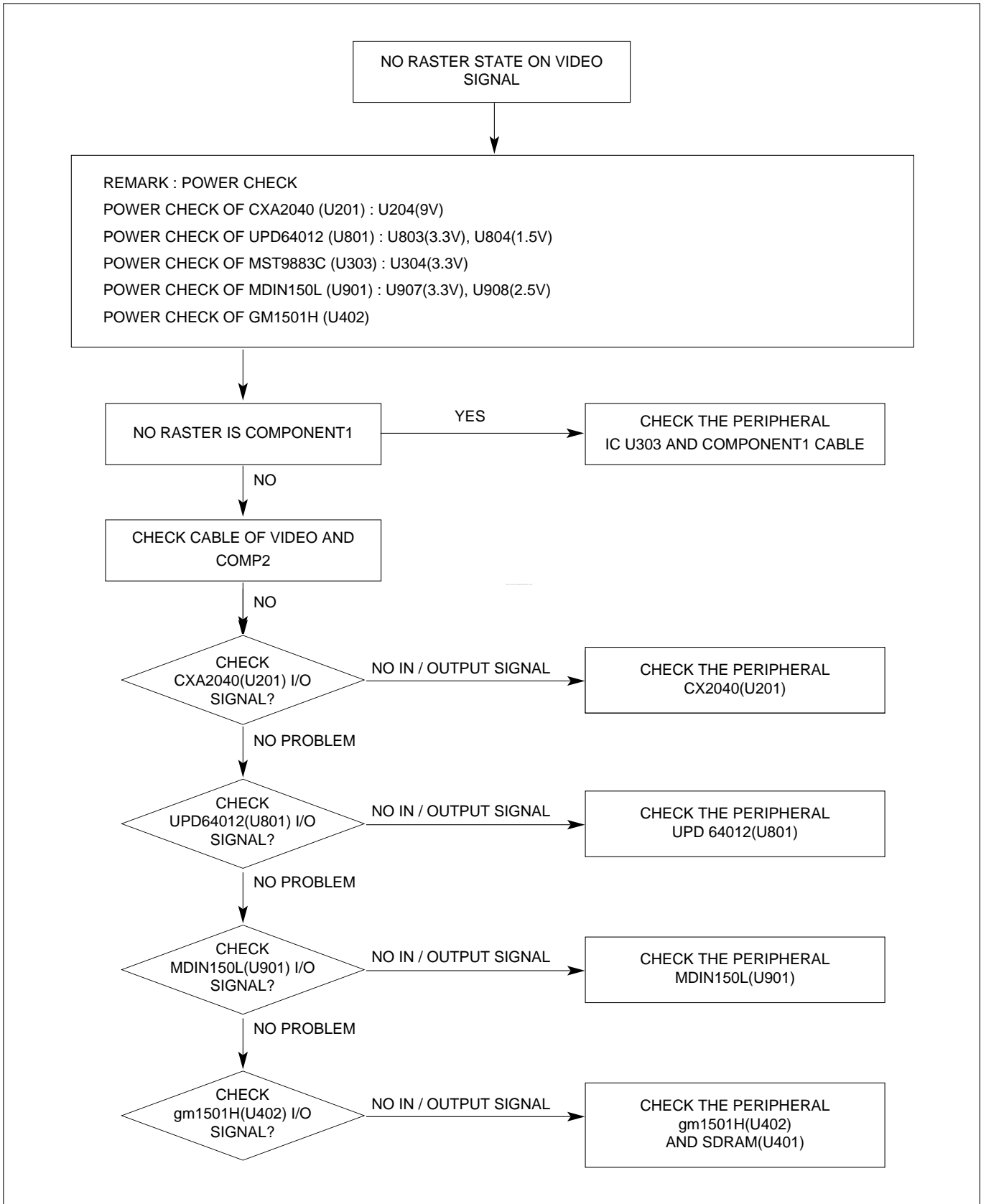

4. NO RASTER STATE ON RGB SIGNAL

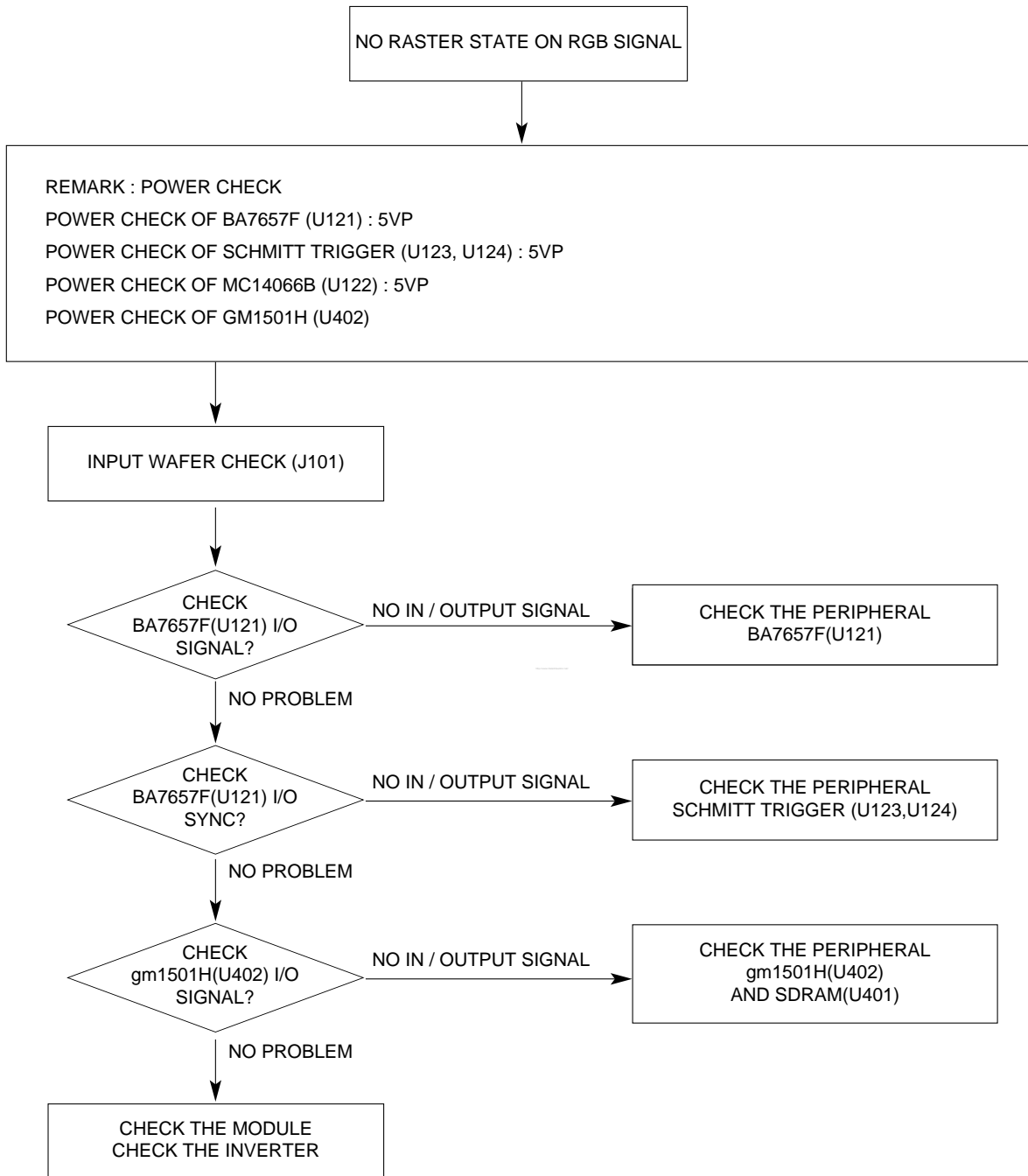

5. NO RASTER STATE ON DVI SIGNAL

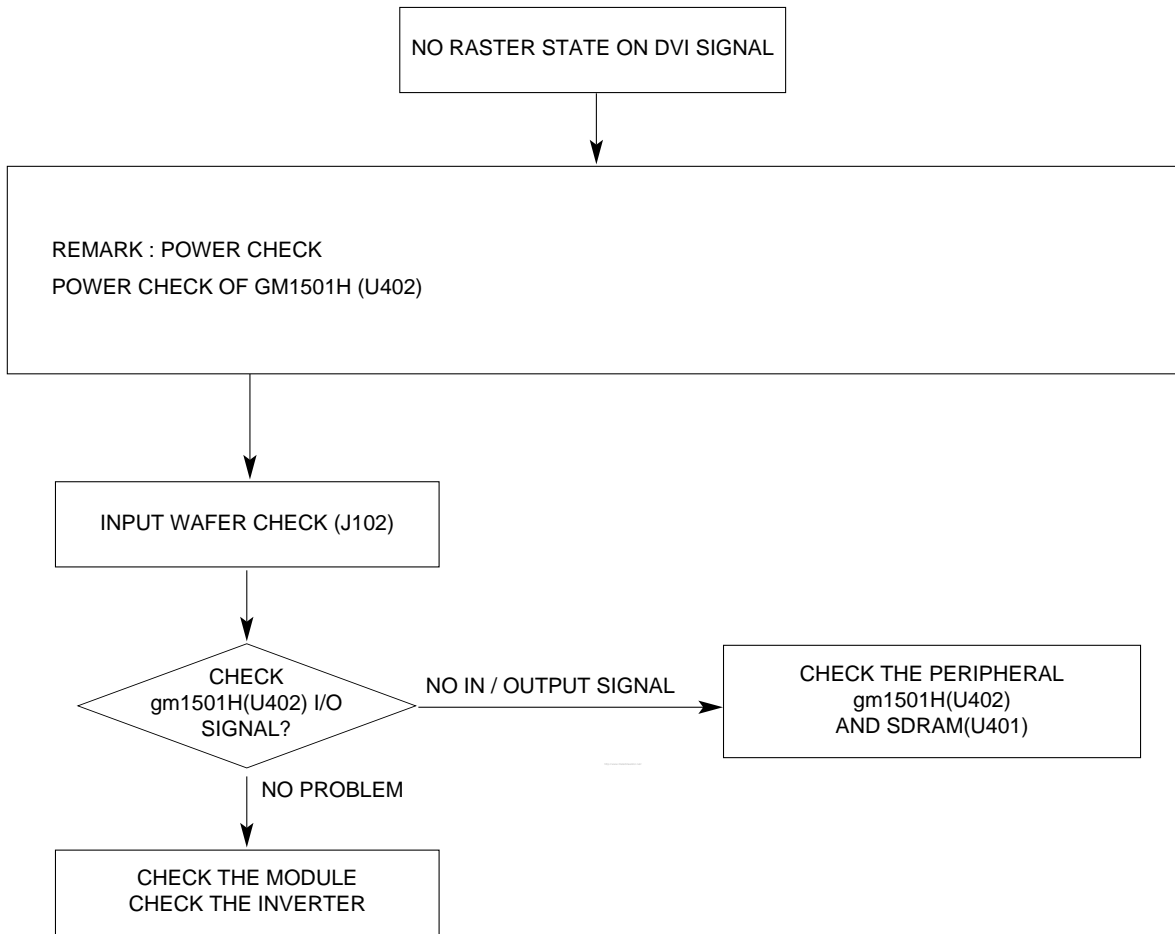

6. SOUND TROUBLE SHOOTING

REMARK : POWER CHECK

POWER CHECK OF MSP3420G (U501) : U522(8V), L502(8V), L501(5V), L505(5V)

POWER CHECK OF TPA3004 (U502) : 18V

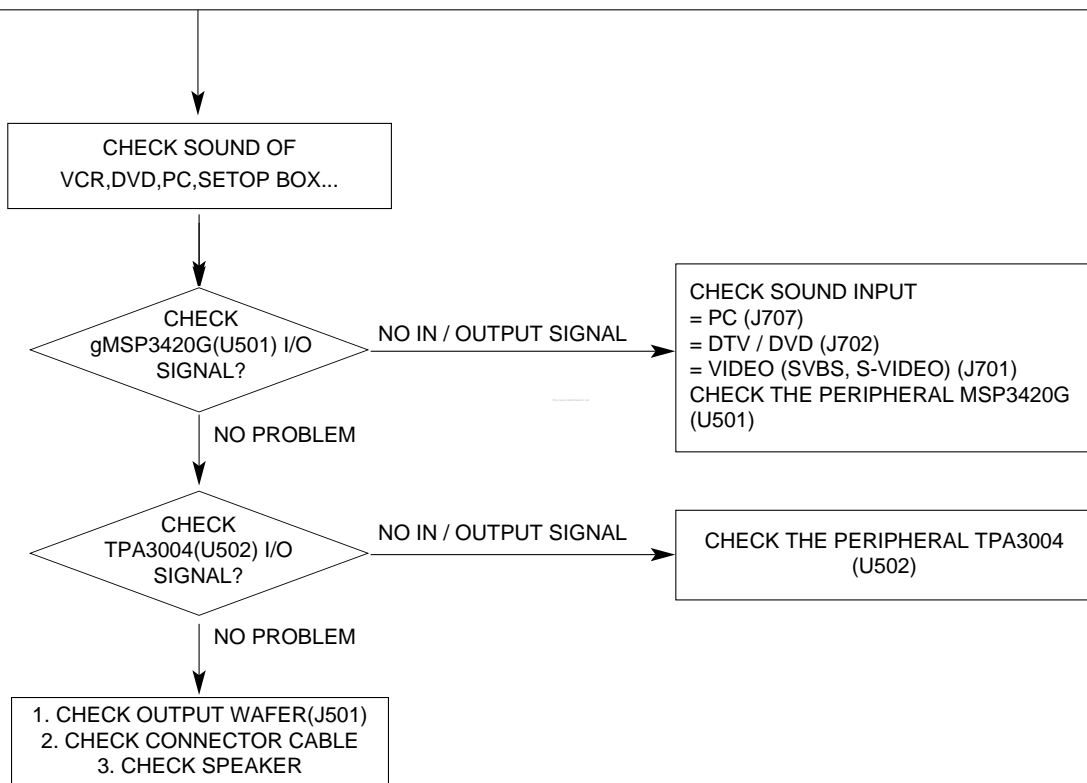

WIRING DIAGRAM

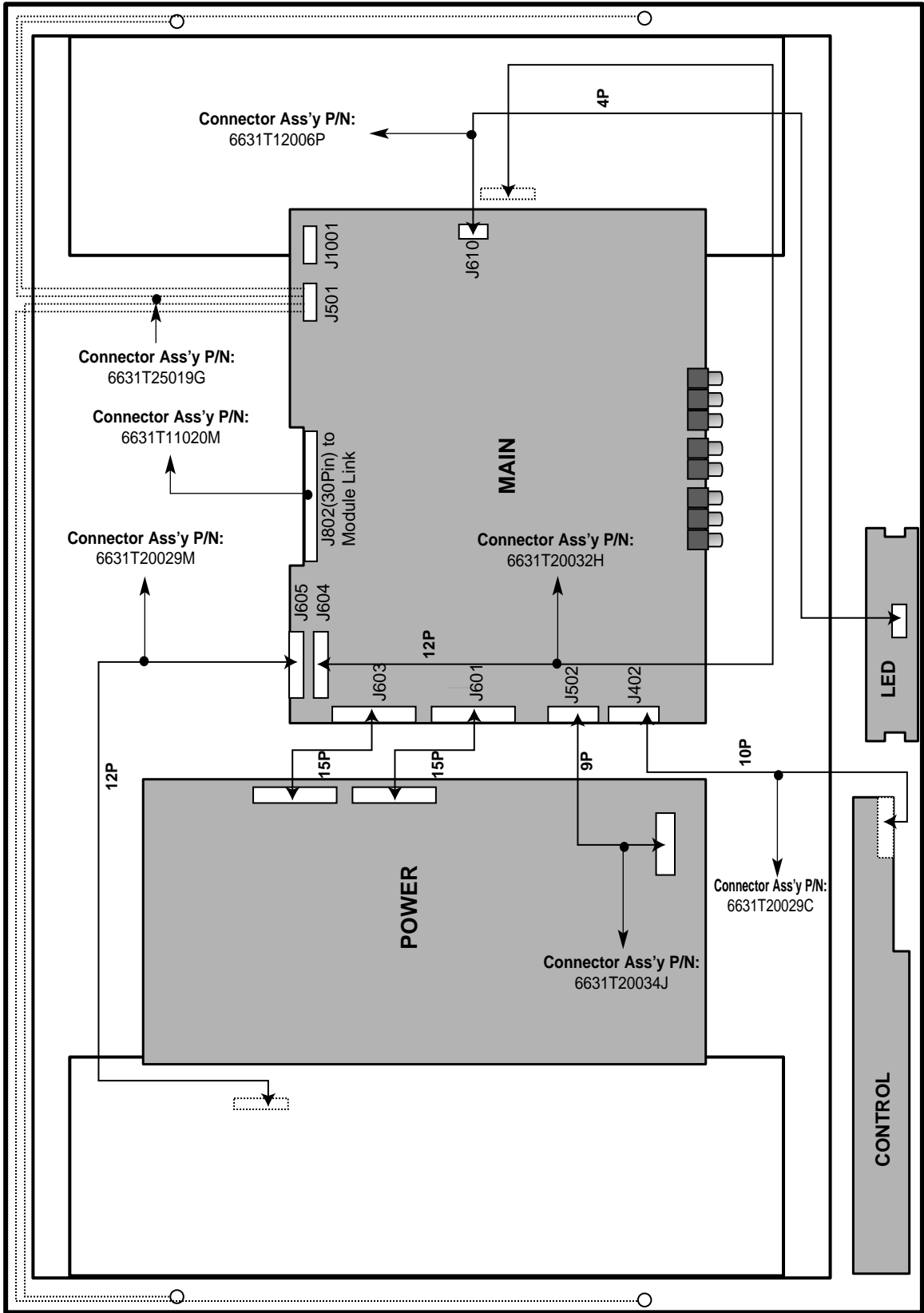

EXPLODED VIEW

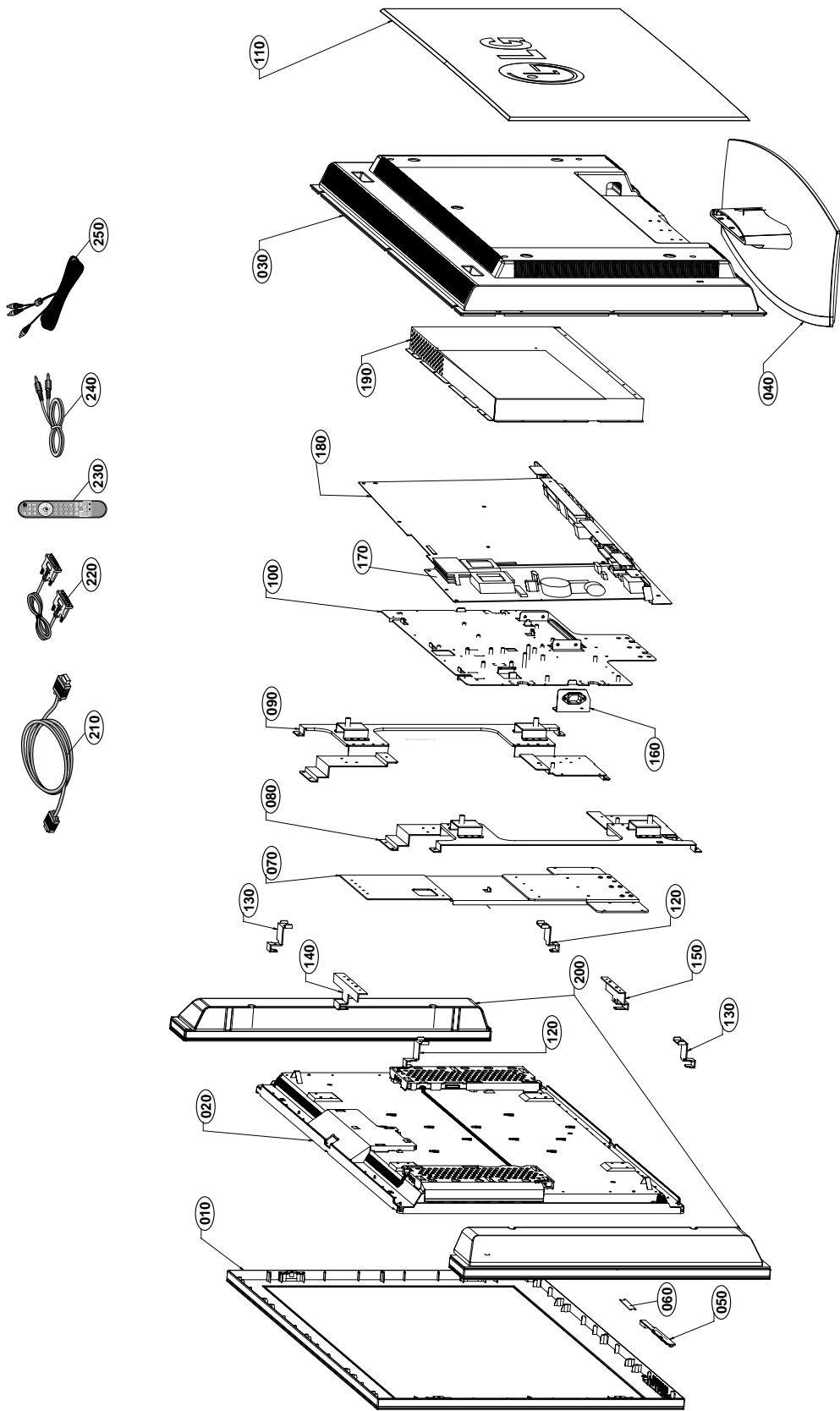

EXPLODED VIEW PARTS LIST

Ref. No.	Part No.	Description
010	3091TKE029L	CABINET ASSEMBLY, L4200TC BRAND 3090TKE005A AV ONLY- SILVER-M4200C-SAFC
	3091TKE029N	CABINET ASSEMBLY, L4200TC BRAND 3090TKE005A AV ONLY- SILVER-C/SKD-M4200C-SAC/SAFC
	3091TKE029M	CABINET ASSEMBLY, L4200TC BRAND 3090TKE005A AV ONLY- BLACK-C/SKD-M4200C-BAC
	3091TKE029K	CABINET ASSEMBLY, L4200TC BRAND 3090TKE005A AV ONLY- BLACK-M4200C-BATC/BAPC
020	6304FLP286A	LCD(LIQUID CRYSTAL DISPLAY), LC420W02-B4K4 LG PHILIPS TFT COLOR B4K3 REV.
	or 6304FLP208A	LCD(LIQUID CRYSTAL DISPLAY), LC420W02-B6 LG PHILIPS TFT COLOR MINI LVDS, P6
030	3809TKE027E	BACK COVER ASSEMBLY, L4200TC 3808TKE004A BACK COVER SPRAYED COMMERCIAL-CKD- M4200C-SAC/SAFC/BAC
	3809TKE027D	BACK COVER ASSEMBLY, L4200TC 3808TKE004A BACK COVER SPRAYED COMMERCIAL,EXPORT- M4200C-BATC/BAPC
040	3043TKK157K	TILT SWIVEL ASSEMBLY, L4200TC (SILVER TOP) 4950TKK758A STAND BODY/REAR COLOR : PEARL BLACK- M4200C-SAFC
	3043TKK157L	TILT SWIVEL ASSEMBLY, L4200TC (SILVER TOP, C/SKD) 4950TKK758A STAND BODY/REAR COLOR : PEARL BLACK- Only M4200C-SAFC
	3043TKK157G	TILT SWIVEL ASSEMBLY, L4200TC 4950TKK758A PEARL BLACK,BK TOP- Only M4200C-BATC
050	6871TST481G	PWB(PCB) ASSEMBLY,SUB, L3700TC (PB FREE) CONTROL TOTAL BRAND CL-70 (WITHOUT COIL - FOR CHAMELEON)
060	6871TST928C	PWB(PCB) ASSEMBLY,SUB, L4200TC (PB FREE) LED & P/SW TOTAL BRAND (42INCH 46INCH)
070	4951TKS144A	METAL ASSEMBLY, FRAME CENTER (L4200A)
080	4951TKS142A	METAL ASSEMBLY, FRAME SIDE(L)
090	4951TKS142B	METAL ASSEMBLY, FRAME SIDE (R)
100	4951TKS195B	METAL ASSEMBLY, FRAME MAIN ASSY (COMMERCIAL)
110	3551TKK511B	COVER ASSEMBLY, L4200AL REAR 3550TKK501A -CKD- Only M4200C-SAFC
	3551TKK511A	COVER ASSEMBLY, L4200 REAR 3550TKK501A DECO- Only L4200C-BATC
120	4950TKK760A	METAL, FRAME SUPPORT SIDE (L4200A)
130	4950TKK760B	METAL, SUPPORT SIDE (L4200A)
140	4950TKK774A	METAL, SUPPORT CENTER TOP (L4200A)
150	4950TKK775A	METAL, SUPPORT CENTER BOTTOM (L4200A)
160	4950TKA145A	METAL, PLATE AC-SOCKET-DUMMY (L4200TC)
170	6871TPT292B	PWB(PCB) ASSEMBLY,POWER, 37-42 CHAMELON CHASSIS PSU POWER TOTAL BRAND KN-POWERTEK
180	3313TL4008A	MAIN TOTAL ASSEMBLY, M4200C (PB FREE) BRAND CL-70
190	4951TKK226A	METAL ASSEMBLY, SHIELD REAR ASSY (L4200TC)
200	3551TKS050E	COVER ASSEMBLY, L4200A SPEAKER . FRONT-SILVER, BACK-PEARL BACK (SP4200S)- Only M4200C-SAFC
	3551TKS050F	COVER ASSEMBLY, L4200A SPEAKER . FRONT-BLACK, BACK-PEARL BACK- Only M4200C-BAPC
210	6850TD9007E	CABLE,D-SUB, UL20276-9C(5.8MM) DT L1800,CORE POS400,,S/HEADMM GRAY(85964) BRAND DM- SILVER
	6850TD9007D	CABLE,D-SUB, UL20276-9C(5.8MM) DT L1800,CORE POS400,,S/HEAD 1.8MM BLACK (9930) DELL 20.1 DM
220	6866TDV004R	CABLE,DVI, UL20276(7.5MM) DT 2000MM GRAY(85964) 20 MODEL DM- SILVER
	6866TDV004J	CABLE,DVI, UL20276 DT 2000MM BLACK (9930) LG883D DM
230	6726TV0001A	REMOTE CONTROLLER RECEIVER, TSOP4838SO1 VISHAY 38.0KHZ LF,HOLDERLESS
240	6852TAZ006J	CORD,A/V, A/V KHC-LG-3-0010 UL 2851 #28-2C 1500MM BLACK(9930) KSD WITH CORE LM295B
250	6852TAZ006V	CORD,A/V, RCA TO STEREO CABLE KCA-ET-0-0043 UL2863AWG25 TWI 1870MM WHITE WH/RED-WH

REPLACEMENT PARTS LIST

CAUTION: BEFORE REPLACING ANY OF THESE COMPONENTS,
 READ CAREFULLY THE **SAFETY PRECAUTIONS** IN THIS MANUAL.

* NOTE : **S** SAFETY Mark **AL** ALTERNATIVE PARTS

DATE: 2005. 05. 20.				
*S	*AL	LOC. NO.	PART NO.	DESCRIPTION / SPECIFICATION
MAIN BOARD				
CAPACITORS				
		C1002	0CE107WF6DC	100UF MVK 16V 20% R/TP(SMD)
		C102	0CE477EF638	470UF KMG 16V M FM5 TP 5
		C103	0CK104CK56A	0.1UF 1608 50V 10% R/TP X7R
		C1049	0CK104CK56A	0.1UF 1608 50V 10% R/TP X7R
		C105	0CE477EF638	470UF KMG 16V M FM5 TP 5
		C1059	0CK104CK56A	0.1UF 1608 50V 10% R/TP X7R
		C106	0CK104CK56A	0.1UF 1608 50V 10% R/TP X7R
		C1061	0CE107WF6DC	100UF MVK 16V 20% R/TP(SMD)
		C110	0CE477EF638	470UF KMG 16V M FM5 TP 5
		C112	0CC101CK41A	100PF 1608 50V 5% R/TP NP0
		C113	0CK104CK56A	0.1UF 1608 50V 10% R/TP X7R
		C114	0CK104CK56A	0.1UF 1608 50V 10% R/TP X7R
		C116	0CK104CK56A	0.1UF 1608 50V 10% R/TP X7R
		C117	0CC101CK41A	100PF 1608 50V 5% R/TP NP0
		C118	0CH3104K566	0.1UF 50V 10% X7R 2012 R/TP
		C119	0CC101CK41A	100PF 1608 50V 5% R/TP NP0
		C120	0CC101CK41A	100PF 1608 50V 5% R/TP NP0
		C121	0CC101CK41A	100PF 1608 50V 5% R/TP NP0
		C122	0CK104CK56A	0.1UF 1608 50V 10% R/TP X7R
		C123	0CC101CK41A	100PF 1608 50V 5% R/TP NP0
		C124	0CK104CK56A	0.1UF 1608 50V 10% R/TP X7R
		C125	0CE476VC6DC	47UF MV 6.3V 20% R/TP(SMD) S
		C126	0CK103CK51A	0.01UF 1608 50V 10% R/TP B(Y
		C127	0CE476VC6DC	47UF MV 6.3V 20% R/TP(SMD) S
		C128	0CK224CF56A	0.22UF 1608 16V 10% R/TP X7R
		C129	0CK224CF56A	0.22UF 1608 16V 10% R/TP X7R
		C130	0CK224CF56A	0.22UF 1608 16V 10% R/TP X7R
		C131	0CK224CF56A	0.22UF 1608 16V 10% R/TP X7R
		C132	0CK103CK51A	0.01UF 1608 50V 10% R/TP B(Y
		C133	0CE476VC6DC	47UF MV 6.3V 20% R/TP(SMD) S
		C134	0CK224CF56A	0.22UF 1608 16V 10% R/TP X7R
		C135	0CK224CF56A	0.22UF 1608 16V 10% R/TP X7R
		C136	0CK103CK51A	0.01UF 1608 50V 10% R/TP B(Y
		C137	0CK224CF56A	0.22UF 1608 16V 10% R/TP X7R
		C138	0CK224CF56A	0.22UF 1608 16V 10% R/TP X7R
		C139	0CE476VC6DC	47UF MV 6.3V 20% R/TP(SMD) S
		C140	0CC101CK41A	100PF 1608 50V 5% R/TP NP0
		C141	0CK104CK56A	0.1UF 1608 50V 10% R/TP X7R
		C142	0CK104CK56A	0.1UF 1608 50V 10% R/TP X7R
		C143	0CC101CK41A	100PF 1608 50V 5% R/TP NP0
		C144	0CK103CK51A	0.01UF 1608 50V 10% R/TP B(Y
		C145	0CE476VC6DC	47UF MV 6.3V 20% R/TP(SMD) S
		C146	0CK103CK51A	0.01UF 1608 50V 10% R/TP B(Y
		C147	0CE476VC6DC	47UF MV 6.3V 20% R/TP(SMD) S
		C148	0CK103CK51A	0.01UF 1608 50V 10% R/TP B(Y
		C149	0CH5471K416	470PF 50V 5% NP0 2012 R/TP
		C150	0CK103CK51A	0.01UF 1608 50V 10% R/TP B(Y
		C151	0CE477EF638	470UF KMG 16V M FM5 TP 5
		C152	0CK474CH94A	"0.47UF 1608 25V 80%,-20% R/T"
		C153	0CK104CK56A	0.1UF 1608 50V 10% R/TP X7R
		C205	0CH8226F691	22UF 16V 20% 105STD (CYL) R/
		C206	0CH3104K566	0.1UF 50V 10% X7R 2012 R/TP

DATE: 2005. 05. 20.				
*S	*AL	LOC. NO.	PART NO.	DESCRIPTION / SPECIFICATION
			C212	0CE225VK6DC 2.2UF MV 50V 20% R/TP(SMD) S
			C222	0CE335VK6DC 3.3UF MV 50V 20% R/TP(SMD) S
			C225	0CH8336H611 33UF 25V M 85STD(CYL) R/TP
			C226	0CH3103K516 10000PF 50V 10% B(Y5P) 2012
			C227	0CE225VK6DC 2.2UF MV 50V 20% R/TP(SMD) S
			C228	0CE225VK6DC 2.2UF MV 50V 20% R/TP(SMD) S
			C229	0CK104CK56A 0.1UF 1608 50V 10% R/TP X7R
			C231	0CC680CK41A 68PF 1608 50V 5% R/TP NP0
			C233	0CE227VF6DC 220UF MV 16V 20% R/TP(SMD) S
			C234	0CH3103K516 10000PF 50V 10% B(Y5P) 2012
			C238	0CE227VF6DC 220UF MV 16V 20% R/TP(SMD) S
			C243	0CK103CK51A 0.01UF 1608 50V 10% R/TP B(Y
			C244	0CK104CK56A 0.1UF 1608 50V 10% R/TP X7R
			C288	0CH8226F691 22UF 16V 20% 105STD (CYL) R/
			C289	0CH3104K566 0.1UF 50V 10% X7R 2012 R/TP
			C291	0CH8226F691 22UF 16V 20% 105STD (CYL) R/
			C292	0CH3104K566 0.1UF 50V 10% X7R 2012 R/TP
			C304	0CH8106F691 10UF 16V 20% 105STD (CYL) R/
			C305	0CE227VF6DC 220UF MV 16V 20% R/TP(SMD) S
			C306	0CH3104K566 0.1UF 50V 10% X7R 2012 R/TP
			C316	0CK104CK56A 0.1UF 1608 50V 10% R/TP X7R
			C317	0CK104CK56A 0.1UF 1608 50V 10% R/TP X7R
			C318	0CK473CK56A 47000PF 1608 50V 10% R/TP X7
			C319	0CK473CK56A 47000PF 1608 50V 10% R/TP X7
			C320	0CH3104K566 0.1UF 50V 10% X7R 2012 R/TP
			C340	0CC102CK41A 1000PF 1608 50V 5% R/TP NP0
			C341	0CK473CK56A 47000PF 1608 50V 10% R/TP X7
			C342	0CK473CK56A 47000PF 1608 50V 10% R/TP X7
			C346	0CK104CK56A 0.1UF 1608 50V 10% R/TP X7R
			C347	0CK473CK56A 47000PF 1608 50V 10% R/TP X7
			C348	0CK473CK56A 47000PF 1608 50V 10% R/TP X7
			C349	0CH8106F691 10UF 16V 20% 105STD (CYL) R/
			C358	0CK104CK56A 0.1UF 1608 50V 10% R/TP X7R
			C360	0CK104CK56A 0.1UF 1608 50V 10% R/TP X7R
			C365	0CK104CK56A 0.1UF 1608 50V 10% R/TP X7R
			C366	0CH8106F691 10UF 16V 20% 105STD (CYL) R/
			C368	0CK104CK56A 0.1UF 1608 50V 10% R/TP X7R
			C369	0CH3104K566 0.1UF 50V 10% X7R 2012 R/TP
			C370	0CH3104K566 0.1UF 50V 10% X7R 2012 R/TP
			C373	0CH3104K566 0.1UF 50V 10% X7R 2012 R/TP
			C376	0CK104CK56A 0.1UF 1608 50V 10% R/TP X7R
			C377	0CH3104K566 0.1UF 50V 10% X7R 2012 R/TP
			C379	0CH3104K566 0.1UF 50V 10% X7R 2012 R/TP
			C381	0CK104CK56A 0.1UF 1608 50V 10% R/TP X7R
			C382	0CK104CK56A 0.1UF 1608 50V 10% R/TP X7R
			C401	0CH3104K566 0.1UF 50V 10% X7R 2012 R/TP
			C402	0CK104CK56A 0.1UF 1608 50V 10% R/TP X7R
			C403	0CK103CK51A 0.01UF 1608 50V 10% R/TP B(Y
			C404	0CK103CK51A 0.01UF 1608 50V 10% R/TP B(Y
			C405	0CK103CK51A 0.01UF 1608 50V 10% R/TP B(Y
			C406	0CK104CK56A 0.1UF 1608 50V 10% R/TP X7R
			C407	0CH8226F691 22UF 16V 20% 105STD (CYL) R/
			C408	0CH3104K566 0.1UF 50V 10% X7R 2012 R/TP
			C409	0CK104CK56A 0.1UF 1608 50V 10% R/TP X7R

DATE: 2005. 05. 20.				
*S	*AL	LOC. NO.	PART NO.	DESCRIPTION / SPECIFICATION
		C410	0CE335VK6DC	3.3UF MV 50V 20% R/TP(SMD) S
		C4101	0CH3104K566	0.1UF 50V 10% X7R 2012 R/TP
		C411	0CK104CK56A	0.1UF 1608 50V 10% R/TP X7R
		C412	0CK104CK56A	0.1UF 1608 50V 10% R/TP X7R
		C413	0CK104CK56A	0.1UF 1608 50V 10% R/TP X7R
		C414	0CK104CK56A	0.1UF 1608 50V 10% R/TP X7R
		C415	0CK104CK56A	0.1UF 1608 50V 10% R/TP X7R
		C416	0CK104CK56A	0.1UF 1608 50V 10% R/TP X7R
		C417	0CK104CK56A	0.1UF 1608 50V 10% R/TP X7R
		C418	0CH3104K566	0.1UF 50V 10% X7R 2012 R/TP
		C420	0CK104CK56A	0.1UF 1608 50V 10% R/TP X7R
		C421	0CK103CK51A	0.01UF 1608 50V 10% R/TP B(Y)
		C422	0CK103CK51A	0.01UF 1608 50V 10% R/TP B(Y)
		C423	0CK103CK51A	0.01UF 1608 50V 10% R/TP B(Y)
		C424	0CK103CK51A	0.01UF 1608 50V 10% R/TP B(Y)
		C425	0CC270CK41A	27PF 1608 50V 5% R/TP NP0
		C426	0CC270CK41A	27PF 1608 50V 5% R/TP NP0
		C427	0CK104CK56A	0.1UF 1608 50V 10% R/TP X7R
		C428	0CK104CK56A	0.1UF 1608 50V 10% R/TP X7R
		C429	0CC150CK41A	15PF 1608 50V 5% R/TP NP0
		C430	0CC270CK41A	27PF 1608 50V 5% R/TP NP0
		C435	0CK104CK56A	0.1UF 1608 50V 10% R/TP X7R
		C459	0CK104CK56A	0.1UF 1608 50V 10% R/TP X7R
		C460	0CH3104K566	0.1UF 50V 10% X7R 2012 R/TP
		C461	0CK104CK56A	0.1UF 1608 50V 10% R/TP X7R
		C462	0CK104CK56A	0.1UF 1608 50V 10% R/TP X7R
		C463	0CC220CK41A	22PF 1608 50V 5% R/TP NP0
		C464	0CC220CK41A	22PF 1608 50V 5% R/TP NP0
		C468	0CH3104K566	0.1UF 50V 10% X7R 2012 R/TP
		C469	0CH3104K566	0.1UF 50V 10% X7R 2012 R/TP
		C470	0CH3104K566	0.1UF 50V 10% X7R 2012 R/TP
		C471	0CH3104K566	0.1UF 50V 10% X7R 2012 R/TP
		C472	0CH3104K566	0.1UF 50V 10% X7R 2012 R/TP
		C473	0CH3104K566	0.1UF 50V 10% X7R 2012 R/TP
		C474	0CH3104K566	0.1UF 50V 10% X7R 2012 R/TP
		C475	0CH3104K566	0.1UF 50V 10% X7R 2012 R/TP
		C476	0CH3104K566	0.1UF 50V 10% X7R 2012 R/TP
		C477	0CH3104K566	0.1UF 50V 10% X7R 2012 R/TP
		C478	0CH3104K566	0.1UF 50V 10% X7R 2012 R/TP
		C479	0CH3104K566	0.1UF 50V 10% X7R 2012 R/TP
		C480	0CH3104K566	0.1UF 50V 10% X7R 2012 R/TP
		C481	0CH3104K566	0.1UF 50V 10% X7R 2012 R/TP
		C482	0CH3104K566	0.1UF 50V 10% X7R 2012 R/TP
		C483	0CH3104K566	0.1UF 50V 10% X7R 2012 R/TP
		C484	0CH3104K566	0.1UF 50V 10% X7R 2012 R/TP
		C487	0CH3104K566	0.1UF 50V 10% X7R 2012 R/TP
		C488	0CH3104K566	0.1UF 50V 10% X7R 2012 R/TP
		C489	0CH3104K566	0.1UF 50V 10% X7R 2012 R/TP
		C490	0CH3104K566	0.1UF 50V 10% X7R 2012 R/TP
		C491	0CH3104K566	0.1UF 50V 10% X7R 2012 R/TP
		C492	0CH3104K566	0.1UF 50V 10% X7R 2012 R/TP
		C493	0CH3104K566	0.1UF 50V 10% X7R 2012 R/TP
		C494	0CH3104K566	0.1UF 50V 10% X7R 2012 R/TP
		C495	0CH3104K566	0.1UF 50V 10% X7R 2012 R/TP
		C496	0CH3104K566	0.1UF 50V 10% X7R 2012 R/TP
		C497	0CH3104K566	0.1UF 50V 10% X7R 2012 R/TP
		C498	0CH3104K566	0.1UF 50V 10% X7R 2012 R/TP
		C499	0CH3104K566	0.1UF 50V 10% X7R 2012 R/TP
		C501	0CK224CF56A	0.22UF 1608 16V 10% R/TP X7R
		C5012	0CK474CH94A	"0.47UF 1608 25V 80%,-20% R/T"
		C5013	0CK474CH94A	"0.47UF 1608 25V 80%,-20% R/T"
		C5014	0CK474CH94A	"0.47UF 1608 25V 80%,-20% R/T"

DATE: 2005. 05. 20.				
*S	*AL	LOC. NO.	PART NO.	DESCRIPTION / SPECIFICATION
		C5015	0CH8106F691	10UF 16V 20% 105STD (CYL) R/
		C5019	0CH8106F691	10UF 16V 20% 105STD (CYL) R/
		C502	0CK224CF56A	0.22UF 1608 16V 10% R/TP X7R
		C5020	0CK103CK51A	0.01UF 1608 50V 10% R/TP B(Y)
		C5021	0CK105CF94A	"1UF 1608 16V 80%,-20% R/TP F"
		C5022	0CK474CH94A	"0.47UF 1608 25V 80%,-20% R/T"
		C503	0CC102CK41A	1000PF 1608 50V 5% R/TP NP0
		C504	0CC102CK41A	1000PF 1608 50V 5% R/TP NP0
		C505	0CE227VF6DC	220UF MV 16V 20% R/TP(SMD) S
		C506	0CK224CF56A	0.22UF 1608 16V 10% R/TP X7R
		C507	0CK104CK56A	0.1UF 1608 50V 10% R/TP X7R
		C508	0CK224CF56A	0.22UF 1608 16V 10% R/TP X7R
		C509	0CK104CK56A	0.1UF 1608 50V 10% R/TP X7R
		C510	0CK104CK56A	0.1UF 1608 50V 10% R/TP X7R
		C511	0CK104CK56A	0.1UF 1608 50V 10% R/TP X7R
		C512	0CK104CK56A	0.1UF 1608 50V 10% R/TP X7R
		C513	0CK224CF56A	0.22UF 1608 16V 10% R/TP X7R
		C514	0CK224CF56A	0.22UF 1608 16V 10% R/TP X7R
		C515	0CK224CF56A	0.22UF 1608 16V 10% R/TP X7R
		C516	0CE107WF6DC	100UF MVK 16V 20% R/TP(SMD)
		C517	0CE107WF6DC	100UF MVK 16V 20% R/TP(SMD)
		C519	0CK224CF56A	0.22UF 1608 16V 10% R/TP X7R
		C523	0CH3103K516	10000PF 50V 10% B(Y5P) 2012
		C524	0CH8106F691	10UF 16V 20% 105STD (CYL) R/
		C525	0CH8106F691	10UF 16V 20% 105STD (CYL) R/
		C526	0CH8106F691	10UF 16V 20% 105STD (CYL) R/
		C527	0CE476WF6DC	47UF MVK 16V 20% R/TP(SMD) S
		C528	0CE475VK6DC	4.7UF MV 50V 20% R/TP(SMD) S
		C529	0CK103CK51A	0.01UF 1608 50V 10% R/TP B(Y)
		C530	0CH3104K566	0.1UF 50V 10% X7R 2012 R/TP
		C531	0CH3104K566	0.1UF 50V 10% X7R 2012 R/TP
		C532	0CH3104K566	0.1UF 50V 10% X7R 2012 R/TP
		C533	0CK104CK56A	0.1UF 1608 50V 10% R/TP X7R
		C534	0CH8476H691	47UF 25V 20% 105STD (CYL) R/
		C535	0CK103CK51A	0.01UF 1608 50V 10% R/TP B(Y)
		C536	0CE107WF6DC	100UF MVK 16V 20% R/TP(SMD)
		C537	0CH3104K566	0.1UF 50V 10% X7R 2012 R/TP
		C538	0CH8476H691	47UF 25V 20% 105STD (CYL) R/
		C539	0CC102CK41A	1000PF 1608 50V 5% R/TP NP0
		C540	0CC102CK41A	1000PF 1608 50V 5% R/TP NP0
		C541	0CC101CK41A	100PF 1608 50V 5% R/TP NP0
		C542	0CK474CH94A	"0.47UF 1608 25V 80%,-20% R/T"
		C543	0CK104CK56A	0.1UF 1608 50V 10% R/TP X7R
		C544	0CC560CK41A	56PF 1608 50V 5% R/TP NP0
		C545	0CK104CK56A	0.1UF 1608 50V 10% R/TP X7R
		C546	0CH5560K416	56PF 50V 5% NP0 2012 R/TP
		C547	0CH3105H946	"1UF 25V 80%,-20% F(Y5V) 2012"
		C548	0CH5560K416	56PF 50V 5% NP0 2012 R/TP
		C549	0CK474CH94A	"0.47UF 1608 25V 80%,-20% R/T"
		C550	0CK105CF94A	"1UF 1608 16V 80%,-20% R/TP F"
		C551	0CK474CH94A	"0.47UF 1608 25V 80%,-20% R/T"
		C552	0CC3R3CK01A	3.3PF 1608 50V 0.25 PF R/TP
		C553	0CK105CF94A	"1UF 1608 16V 80%,-20% R/TP F"
		C554	0CK105CF94A	"1UF 1608 16V 80%,-20% R/TP F"
		C555	0CK105CF94A	"1UF 1608 16V 80%,-20% R/TP F"
		C556	0CK105CF94A	"1UF 1608 16V 80%,-20% R/TP F"
		C557	0CK152CK51A	1500PF 1608 50V 10% R/TP B(Y)
		C558	0CK474CH94A	"0.47UF 1608 25V 80%,-20% R/T"
		C559	0CK104CK56A	0.1UF 1608 50V 10% R/TP X7R
		C560	0CK152CK51A	1500PF 1608 50V 10% R/TP B(Y)
		C561	0CC271CK41A	270PF 1608 50V 5% R/TP NP0
		C562	0CC3R3CK01A	3.3PF 1608 50V 0.25 PF R/TP

DATE: 2005. 05. 20.				
*S	*AL	LOC. NO.	PART NO.	DESCRIPTION / SPECIFICATION
		C563	0CH3105H946	"1UF 25V 80%,-20% F(Y5V) 2012"
		C564	0CH8476H691	47UF 25V 20% 105STD (CYL) R/
		C565	0CK104CK56A	0.1UF 1608 50V 10% R/TP X7R
		C566	0CK104CK56A	0.1UF 1608 50V 10% R/TP X7R
		C567	0CK474CH94A	"0.47UF 1608 25V 80%,-20% R/T"
		C568	0CK103CK51A	0.01UF 1608 50V 10% R/TP B(Y
		C569	0CC102CK41A	1000PF 1608 50V 5% R/TP NP0
		C570	0CK474CH94A	"0.47UF 1608 25V 80%,-20% R/T"
		C571	0CK474CH94A	"0.47UF 1608 25V 80%,-20% R/T"
		C572	0CK103CK51A	0.01UF 1608 50V 10% R/TP B(Y
		C573	0CC102CK41A	1000PF 1608 50V 5% R/TP NP0
		C574	0CK332CK51A	3300PF 1608 50V 10% R/TP B(Y
		C575	0CK332CK51A	3300PF 1608 50V 10% R/TP B(Y
		C576	0CK474CH94A	"0.47UF 1608 25V 80%,-20% R/T"
		C577	0CE107WF6DC	100UF MVK 16V 20% R/TP(SMD)
		C578	0CH3103K516	10000PF 50V 10% B(Y5P) 2012
		C579	0CK104CK56A	0.1UF 1608 50V 10% R/TP X7R
		C580	0CK104CK56A	0.1UF 1608 50V 10% R/TP X7R
		C581	0CE107WF6DC	100UF MVK 16V 20% R/TP(SMD)
		C582	0CK104CK56A	0.1UF 1608 50V 10% R/TP X7R
		C583	0CH3105H946	"1UF 25V 80%,-20% F(Y5V) 2012"
		C584	0CH3103K516	10000PF 50V 10% B(Y5P) 2012
		C585	0CE107WF6DC	100UF MVK 16V 20% R/TP(SMD)
		C586	0CK105CF94A	"1UF 1608 16V 80%,-20% R/TP F"
		C587	0CH8106F691	10UF 16V 20% 105STD (CYL) R/
		C588	0CH8106F691	10UF 16V 20% 105STD (CYL) R/
		C602	0CH3103K516	10000PF 50V 10% B(Y5P) 2012
		C603	0CE227VF6DC	220UF MV 16V 20% R/TP(SMD) S
		C604	0CK105CF94A	"1UF 1608 16V 80%,-20% R/TP F"
		C605	0CC102CK41A	1000PF 1608 50V 5% R/TP NP0
		C606	0CK103CK51A	0.01UF 1608 50V 10% R/TP B(Y
		C607	0CK104CK56A	0.1UF 1608 50V 10% R/TP X7R
		C608	0CH8476K611	47UF 50V 20% 85STD (CYL) R/T
		C609	0CK104CK56A	0.1UF 1608 50V 10% R/TP X7R
		C610	0CK104CK56A	0.1UF 1608 50V 10% R/TP X7R
		C611	0CK103CK51A	0.01UF 1608 50V 10% R/TP B(Y
		C612	0CE477EF638	470UF KMG 16V M FM5 TP 5
		C614	0CH3103K516	10000PF 50V 10% B(Y5P) 2012
		C615	0CK105CF94A	"1UF 1608 16V 80%,-20% R/TP F"
		C616	0CE227VF6DC	220UF MV 16V 20% R/TP(SMD) S
		C617	0CK104CK56A	0.1UF 1608 50V 10% R/TP X7R
		C618	0CC102CK41A	1000PF 1608 50V 5% R/TP NP0
		C619	0CE477EF638	470UF KMG 16V M FM5 TP 5
		C620	0CK103CK51A	0.01UF 1608 50V 10% R/TP B(Y
		C621	0CK104CK56A	0.1UF 1608 50V 10% R/TP X7R
		C622	0CK103CK51A	0.01UF 1608 50V 10% R/TP B(Y
		C623	0CE477EF638	470UF KMG 16V M FM5 TP 5
		C624	0CH8226F691	22UF 16V 20% 105STD (CYL) R/
		C625	0CH3104K566	0.1UF 50V 10% X7R 2012 R/TP
		C627	0CH8476K611	47UF 50V 20% 85STD (CYL) R/T
		C629	0CK103CK51A	0.01UF 1608 50V 10% R/TP B(Y
		C632	0CE227VF6DC	220UF MV 16V 20% R/TP(SMD) S
		C636	0CC102CK41A	1000PF 1608 50V 5% R/TP NP0
		C639	0CK105CF94A	"1UF 1608 16V 80%,-20% R/TP F"
		C642	0CE107WF6DC	100UF MVK 16V 20% R/TP(SMD)
		C645	0CH3104K566	0.1UF 50V 10% X7R 2012 R/TP
		C646	0CH8226F691	22UF 16V 20% 105STD (CYL) R/
		C648	0CH3104K566	0.1UF 50V 10% X7R 2012 R/TP
		C651	0CE227VF6DC	220UF MV 16V 20% R/TP(SMD) S
		C654	0CK104CK56A	0.1UF 1608 50V 10% R/TP X7R
		C655	0CH3104K566	0.1UF 50V 10% X7R 2012 R/TP
		C656	0CK104CK56A	0.1UF 1608 50V 10% R/TP X7R

DATE: 2005. 05. 20.				
*S	*AL	LOC. NO.	PART NO.	DESCRIPTION / SPECIFICATION
		C659	0CE227VF6DC	220UF MV 16V 20% R/TP(SMD) S
		C660	0CK104CK56A	0.1UF 1608 50V 10% R/TP X7R
		C661	0CK103CK51A	0.01UF 1608 50V 10% R/TP B(Y
		C662	0CH8476K611	47UF 50V 20% 85STD (CYL) R/T
		C664	0CH3104K566	0.1UF 50V 10% X7R 2012 R/TP
		C666	0CH8226F691	22UF 16V 20% 105STD (CYL) R/
		C667	0CH8226F691	470UF KMG 16V M FM5 TP 5
		C669	0CH3104K566	0.1UF 50V 10% X7R 2012 R/TP
		C671	0CE107WF6DC	100UF MVK 16V 20% R/TP(SMD)
		C678	0CH8106F691	10UF 16V 20% 105STD (CYL) R/
		C679	0CK103CK51A	0.01UF 1608 50V 10% R/TP B(Y
		C680	0CE477EF638	470UF KMG 16V M FM5 TP 5
		C681	0CE477EF638	470UF KMG 16V M FM5 TP 5
		C682	0CK104CK56A	0.1UF 1608 50V 10% R/TP X7R
		C683	0CK104CK56A	0.1UF 1608 50V 10% R/TP X7R
		C702	0CC471CK41A	470PF 1608 50V 5% R/TP NP0
		C704	0CC471CK41A	470PF 1608 50V 5% R/TP NP0
		C706	0CC471CK41A	470PF 1608 50V 5% R/TP NP0
		C708	0CC471CK41A	470PF 1608 50V 5% R/TP NP0
		C713	0CC471CK41A	470PF 1608 50V 5% R/TP NP0
		C714	0CC471CK41A	470PF 1608 50V 5% R/TP NP0
		C720	0CC331CK41A	330PF 1608 50V 5% R/TP NP0
		C725	0CC101CK41A	100PF 1608 50V 5% R/TP NP0
		C726	0CC471CK41A	470PF 1608 50V 5% R/TP NP0
		C727	0CC101CK41A	100PF 1608 50V 5% R/TP NP0
		C728	0CC471CK41A	470PF 1608 50V 5% R/TP NP0
		C730	0CC471CK41A	470PF 1608 50V 5% R/TP NP0
		C732	0CC471CK41A	470PF 1608 50V 5% R/TP NP0
		C735	0CE227VF6DC	220UF MV 16V 20% R/TP(SMD) S
		C801	0CK104CK56A	0.1UF 1608 50V 10% R/TP X7R
		C802	0CH3104K566	0.1UF 50V 10% X7R 2012 R/TP
		C803	0CK104CK56A	0.1UF 1608 50V 10% R/TP X7R
		C804	0CK104CK56A	0.1UF 1608 50V 10% R/TP X7R
		C805	0CH3104K566	0.1UF 50V 10% X7R 2012 R/TP
		C806	0CK104CK56A	0.1UF 1608 50V 10% R/TP X7R
		C807	0CH3104K566	0.1UF 50V 10% X7R 2012 R/TP
		C808	0CK104CK56A	0.1UF 1608 50V 10% R/TP X7R
		C809	0CH3104K566	0.1UF 50V 10% X7R 2012 R/TP
		C810	0CK104CK56A	0.1UF 1608 50V 10% R/TP X7R
		C811	0CH3104K566	0.1UF 50V 10% X7R 2012 R/TP
		C812	0CK104CK56A	0.1UF 1608 50V 10% R/TP X7R
		C813	0CK106EF56A	10UF 3216 16V 10% X7R R/TP
		C814	0CK103CK51A	0.01UF 1608 50V 10% R/TP B(Y
		C815	0CK103CK51A	0.01UF 1608 50V 10% R/TP B(Y
		C816	0CK103CK51A	0.01UF 1608 50V 10% R/TP B(Y
		C817	0CK103CK51A	0.01UF 1608 50V 10% R/TP B(Y
		C818	0CH3104K566	0.1UF 50V 10% X7R 2012 R/TP
		C819	0CH3104K566	0.1UF 50V 10% X7R 2012 R/TP
		C820	0CK104CK56A	0.1UF 1608 50V 10% R/TP X7R
		C821	0CK104CK56A	0.1UF 1608 50V 10% R/TP X7R
		C822	0CK104CK56A	0.1UF 1608 50V 10% R/TP X7R
		C823	0CH3104K566	0.1UF 50V 10% X7R 2012 R/TP
		C824	0CH3104K566	0.1UF 50V 10% X7R 2012 R/TP
		C825	0CH3104K566	0.1UF 50V 10% X7R 2012 R/TP
		C826	0CH3104K566	0.1UF 50V 10% X7R 2012 R/TP
		C827	0CH3104K566	0.1UF 50V 10% X7R 2012 R/TP
		C828	0CH3104K566	0.1UF 50V 10% X7R 2012 R/TP
		C829	0CH3104K566	0.1UF 50V 10% X7R 2012 R/TP
		C830	0CH3104K566	0.1UF 50V 10% X7R 2012 R/TP
		C831	0CH3104K566	0.1UF 50V 10% X7R 2012 R/TP
		C832	0CH3104K566	0.1UF 50V 10% X7R 2012 R/TP
		C833	0CH3104K566	0.1UF 50V 10% X7R 2012 R/TP

DATE: 2005. 05. 20.				
*S	*AL	LOC. NO.	PART NO.	DESCRIPTION / SPECIFICATION
		C834	0CH3104K566	0.1UF 50V 10% X7R 2012 R/TP
		C835	0CH3104K566	0.1UF 50V 10% X7R 2012 R/TP
		C836	0CH3104K566	0.1UF 50V 10% X7R 2012 R/TP
		C837	0CH3104K566	0.1UF 50V 10% X7R 2012 R/TP
		C838	0CH3104K566	0.1UF 50V 10% X7R 2012 R/TP
		C839	0CH3104K566	0.1UF 50V 10% X7R 2012 R/TP
		C840	0CH3104K566	0.1UF 50V 10% X7R 2012 R/TP
		C841	0CH3104K566	0.1UF 50V 10% X7R 2012 R/TP
		C842	0CH3104K566	0.1UF 50V 10% X7R 2012 R/TP
		C843	0CH3104K566	0.1UF 50V 10% X7R 2012 R/TP
		C844	0CH3104K566	0.1UF 50V 10% X7R 2012 R/TP
		C846	0CE227VF6DC	220UF MV 16V 20% R/TP(SMD) S
		C847	0CE227VF6DC	220UF MV 16V 20% R/TP(SMD) S
		C848	0CC220CK41A	22PF 1608 50V 5% R/TP NP0
		C849	0CC220CK41A	22PF 1608 50V 5% R/TP NP0
		C850	0CE227VF6DC	220UF MV 16V 20% R/TP(SMD) S
		C852	0CK103CK51A	0.01UF 1608 50V 10% R/TP B(Y)
		C853	0CK103CK51A	0.01UF 1608 50V 10% R/TP B(Y)
		C854	0CK103CK51A	0.01UF 1608 50V 10% R/TP B(Y)
		C860	0CK103CK51A	0.01UF 1608 50V 10% R/TP B(Y)
		C861	0CK103CK51A	0.01UF 1608 50V 10% R/TP B(Y)
		C862	0CK103CK51A	0.01UF 1608 50V 10% R/TP B(Y)
		C901	0CC3R3CK01A	3.3PF 1608 50V 0.25 PF R/TP
		C9010	0CK104CK56A	0.1UF 1608 50V 10% R/TP X7R
		C9011	0CK104CK56A	0.1UF 1608 50V 10% R/TP X7R
		C9012	0CC821CK41A	820PF 1608 50V 5% R/TP NP0
		C902	0CC3R3CK01A	3.3PF 1608 50V 0.25 PF R/TP
		C904	0CH8226F691	22UF 16V 20% 105STD (CYL) R/
		C905	0CK104CK56A	0.1UF 1608 50V 10% R/TP X7R
		C906	0CK104CK56A	0.1UF 1608 50V 10% R/TP X7R
		C907	0CH3104K566	0.1UF 50V 10% X7R 2012 R/TP
		C908	0CH3104K566	0.1UF 50V 10% X7R 2012 R/TP
		C909	0CK104CK56A	0.1UF 1608 50V 10% R/TP X7R
		C910	0CH3104K566	0.1UF 50V 10% X7R 2012 R/TP
		C911	0CH3104K566	0.1UF 50V 10% X7R 2012 R/TP
		C912	0CH3104K566	0.1UF 50V 10% X7R 2012 R/TP
		C913	0CH3104K566	0.1UF 50V 10% X7R 2012 R/TP
		C914	0CE227VF6DC	220UF MV 16V 20% R/TP(SMD) S
		C915	0CE227VF6DC	220UF MV 16V 20% R/TP(SMD) S
		C916	0CH8226F691	22UF 16V 20% 105STD (CYL) R/
		C917	0CH3104K566	0.1UF 50V 10% X7R 2012 R/TP
		C918	0CK104CK56A	0.1UF 1608 50V 10% R/TP X7R
		C919	0CH3104K566	0.1UF 50V 10% X7R 2012 R/TP
		C920	0CH3104K566	0.1UF 50V 10% X7R 2012 R/TP
		C921	0CH3104K566	0.1UF 50V 10% X7R 2012 R/TP
		C922	0CH3104K566	0.1UF 50V 10% X7R 2012 R/TP
		C923	0CH3104K566	0.1UF 50V 10% X7R 2012 R/TP
		C924	0CH3104K566	0.1UF 50V 10% X7R 2012 R/TP
		C925	0CH8226F691	22UF 16V 20% 105STD (CYL) R/
		C926	0CK104CK56A	0.1UF 1608 50V 10% R/TP X7R
		C927	0CH3104K566	0.1UF 50V 10% X7R 2012 R/TP
		C928	0CH3104K566	0.1UF 50V 10% X7R 2012 R/TP
		C929	0CH3104K566	0.1UF 50V 10% X7R 2012 R/TP
		C930	0CH3104K566	0.1UF 50V 10% X7R 2012 R/TP
		C931	0CH8226F691	22UF 16V 20% 105STD (CYL) R/
		C932	0CH3104K566	0.1UF 50V 10% X7R 2012 R/TP
		C933	0CH3104K566	0.1UF 50V 10% X7R 2012 R/TP
		C934	0CK104CK56A	0.1UF 1608 50V 10% R/TP X7R
		C935	0CK104CK56A	0.1UF 1608 50V 10% R/TP X7R
		C936	0CH8226F691	22UF 16V 20% 105STD (CYL) R/
		C937	0CH3104K566	0.1UF 50V 10% X7R 2012 R/TP
		C938	0CH3104K566	0.1UF 50V 10% X7R 2012 R/TP

DATE: 2005. 05. 20.				
*S	*AL	LOC. NO.	PART NO.	DESCRIPTION / SPECIFICATION
		C939	0CH3104K566	0.1UF 50V 10% X7R 2012 R/TP
		C940	0CH3104K566	0.1UF 50V 10% X7R 2012 R/TP
		C941	0CH3104K566	0.1UF 50V 10% X7R 2012 R/TP
		C942	0CH3104K566	0.1UF 50V 10% X7R 2012 R/TP
		C943	0CH3104K566	0.1UF 50V 10% X7R 2012 R/TP
		C944	0CH3104K566	0.1UF 50V 10% X7R 2012 R/TP
		C945	0CH3104K566	0.1UF 50V 10% X7R 2012 R/TP
		C946	0CH3104K566	0.1UF 50V 10% X7R 2012 R/TP
		C948	0CC821CK41A	820PF 1608 50V 5% R/TP NP0
		C953	0CH8226F691	22UF 16V 20% 105STD (CYL) R/
		C954	0CK104CK56A	0.1UF 1608 50V 10% R/TP X7R
		C955	0CK104CK56A	0.1UF 1608 50V 10% R/TP X7R
		C956	0CH3104K566	0.1UF 50V 10% X7R 2012 R/TP
		C957	0CH3104K566	0.1UF 50V 10% X7R 2012 R/TP
		C971	0CH3104K566	0.1UF 50V 10% X7R 2012 R/TP
		C972	0CH3104K566	0.1UF 50V 10% X7R 2012 R/TP
		C973	0CH3104K566	0.1UF 50V 10% X7R 2012 R/TP
		C985	0CH3104K566	0.1UF 50V 10% X7R 2012 R/TP
		C986	0CH3104K566	0.1UF 50V 10% X7R 2012 R/TP
		C987	0CH3104K566	0.1UF 50V 10% X7R 2012 R/TP
DIODEs				
		D1002	0DD184009AA	KDS184 TP KEC - 85V --- 30
		D1003	0DD184009AA	KDS184 TP KEC - 85V --- 30
		D101	0DS226009AA	KDS226 TP KEC - 80V -- 4NSE
		D102	0DS226009AA	KDS226 TP KEC - 80V -- 4NSE
		D103	0DS226009AA	KDS226 TP KEC - 80V -- 4NSE
		D104	0DS226009AA	KDS226 TP KEC - 80V -- 4NSE
		D105	0DS226009AA	KDS226 TP KEC - 80V -- 4NSE
		D106	0DD184009AA	KDS184 TP KEC - 85V --- 30
		D107	0DD184009AA	KDS184 TP KEC - 85V --- 30
		D108	0DD184009AA	KDS184 TP KEC - 85V --- 30
		D109	0DD184009AA	KDS184 TP KEC - 85V --- 30
		D110	0DS226009AA	KDS226 TP KEC - 80V -- 4NSE
		D111	0DS226009AA	KDS226 TP KEC - 80V -- 4NSE
		D112	0DS226009AA	KDS226 TP KEC - 80V -- 4NSE
		D113	0DS226009AA	KDS226 TP KEC - 80V -- 4NSE
		D114	0DS226009AA	KDS226 TP KEC - 80V -- 4NSE
		D115	0DS226009AA	KDS226 TP KEC - 80V -- 4NSE
		D116	0DS226009AA	KDS226 TP KEC - 80V -- 4NSE
		D117	0DS226009AA	KDS226 TP KEC - 80V -- 4NSE
		D118	0DS226009AA	KDS226 TP KEC - 80V -- 4NSE
		D119	0DS226009AA	KDS226 TP KEC - 80V -- 4NSE
		D120	0DD184009AA	KDS184 TP KEC - 85V --- 30
		D121	0DD184009AA	KDS184 TP KEC - 85V --- 30
		D130	0DSON00138A	"MMBD301LT1G,LF ON SEMI R/TP"
		D131	0DSON00138A	"MMBD301LT1G,LF ON SEMI R/TP"
		D132	0DSON00138A	"MMBD301LT1G,LF ON SEMI R/TP"
		D505	0DSON00138A	"MMBD301LT1G,LF ON SEMI R/TP"
		D506	0DSON00138A	"MMBD301LT1G,LF ON SEMI R/TP"
		D507	0DSON00138A	"MMBD301LT1G,LF ON SEMI R/TP"
		D508	0DSON00138A	"MMBD301LT1G,LF ON SEMI R/TP"
		D603	0DS226009AA	KDS226 TP KEC - 80V -- 4NSE
		D604	0DS226009AA	KDS226 TP KEC - 80V -- 4NSE
		U102	0DRCE00018A	"PACDN004SR,LF CAMD R/TP SOT1"
		U103	0DRCE00018A	"PACDN004SR,LF CAMD R/TP SOT1"
		U105	0DRCE00018A	"PACDN004SR,LF CAMD R/TP SOT1"
		U106	0DRCE00018A	"PACDN004SR,LF CAMD R/TP SOT1"
		U108	0DRCE00018A	"PACDN004SR,LF CAMD R/TP SOT1"
		U109	0DRCE00018A	"PACDN004SR,LF CAMD R/TP SOT1"
		U110	0DRCE00018A	"PACDN004SR,LF CAMD R/TP SOT1"

DATE: 2005. 05. 20.				
*S	*AL	LOC. NO.	PART NO.	DESCRIPTION / SPECIFICATION
		U111	0DRCE00018A	"PACDN004SR,LF CAMD R/TP SOT1"
		ZD1001	0DZ360009EB	UDZ 3.6B TP ROHM SOD323 200M
		ZD101	0DZ560009DA	UDZ S 5.6B TP ROHM-K SOD323
		ZD102	0DZ560009DA	UDZ S 5.6B TP ROHM-K SOD323
		ZD103	0DZ560009DA	UDZ S 5.6B TP ROHM-K SOD323
		ZD104	0DZ560009DA	UDZ S 5.6B TP ROHM-K SOD323
		ZD105	0DZ560009DA	UDZ S 5.6B TP ROHM-K SOD323
		ZD106	0DZ560009DA	UDZ S 5.6B TP ROHM-K SOD323
		ZD107	0DZ560009DA	UDZ S 5.6B TP ROHM-K SOD323
		ZD108	0DZ560009DA	UDZ S 5.6B TP ROHM-K SOD323
		ZD109	0DZ560009DA	UDZ S 5.6B TP ROHM-K SOD323
		ZD110	0DZ560009DA	UDZ S 5.6B TP ROHM-K SOD323
		ZD111	0DZ560009DA	UDZ S 5.6B TP ROHM-K SOD323
		ZD112	0DZ560009DA	UDZ S 5.6B TP ROHM-K SOD323
		ZD113	0DZ560009DA	UDZ S 5.6B TP ROHM-K SOD323
		ZD114	0DZ560009DA	UDZ S 5.6B TP ROHM-K SOD323
		ZD401	0DZ910009FE	UDZS 9.1B TP ROHM - - 9.1V -
		ZD402	0DZ910009FE	UDZS 9.1B TP ROHM - - 9.1V -
		ZD403	0DZ910009FE	UDZS 9.1B TP ROHM - - 9.1V -
		ZD404	0DZ560009DA	UDZ S 5.6B TP ROHM-K SOD323
		ZD501	0DZ560009DA	UDZ S 5.6B TP ROHM-K SOD323
		ZD502	0DZ560009DA	UDZ S 5.6B TP ROHM-K SOD323
		ZD503	0DZ560009DA	UDZ S 5.6B TP ROHM-K SOD323
		ZD504	0DZ560009DA	UDZ S 5.6B TP ROHM-K SOD323
		ZD505	0DZ560009DA	UDZ S 5.6B TP ROHM-K SOD323
		ZD601	0DZ560009DA	UDZ S 5.6B TP ROHM-K SOD323
		ZD701	0DZ560009DA	UDZ S 5.6B TP ROHM-K SOD323
		ZD702	0DZ560009DA	UDZ S 5.6B TP ROHM-K SOD323
		ZD703	0DZ560009DA	UDZ S 5.6B TP ROHM-K SOD323
		ZD704	0DZ560009DA	UDZ S 5.6B TP ROHM-K SOD323
		ZD705	0DZ560009DA	UDZ S 5.6B TP ROHM-K SOD323
		ZD706	0DZ560009DA	UDZ S 5.6B TP ROHM-K SOD323
		ZD707	0DZ560009DA	UDZ S 5.6B TP ROHM-K SOD323
		ZD708	0DZ560009DA	UDZ S 5.6B TP ROHM-K SOD323
		ZD709	0DZ560009DA	UDZ S 5.6B TP ROHM-K SOD323
		ZD710	0DZ560009DA	UDZ S 5.6B TP ROHM-K SOD323
		ZD711	0DZ560009DA	UDZ S 5.6B TP ROHM-K SOD323
		ZD712	0DZ560009DA	UDZ S 5.6B TP ROHM-K SOD323
		ZD713	0DZ560009DA	UDZ S 5.6B TP ROHM-K SOD323
		ZD714	0DZ560009DA	UDZ S 5.6B TP ROHM-K SOD323
		ZD715	0DZ560009DA	UDZ S 5.6B TP ROHM-K SOD323
		ZD716	0DZ560009DA	UDZ S 5.6B TP ROHM-K SOD323
		ZD719	0DZ560009DA	UDZ S 5.6B TP ROHM-K SOD323
		ZD720	0DZ560009DA	UDZ S 5.6B TP ROHM-K SOD323
		ZD721	0DZ560009DA	UDZ S 5.6B TP ROHM-K SOD323
		ZD722	0DZ560009DA	UDZ S 5.6B TP ROHM-K SOD323
		ZD723	0DZ560009DA	UDZ S 5.6B TP ROHM-K SOD323
		ZD724	0DZ560009DA	UDZ S 5.6B TP ROHM-K SOD323
ICs				
		Q404	0IKE704200J	KIA7042AF SOT-89 TP 4.2V VOL
		Q506	0IKE704200J	KIA7042AF SOT-89 TP 4.2V VOL
		U101	0ISS780800J	"KA78M08R 3P,D-PAK TP VOL. RE"
		U114	0ISS524202C	S524A40X21(SC70) SAMSUNG ELE
		U115	0ISS524202C	S524A40X21(SC70) SAMSUNG ELE
		U116	0IPRPAD024A	"AD8009JRTZ,LF ANALOG DEVICE"
		U117	0IPRPAD024A	"AD8009JRTZ,LF ANALOG DEVICE"
		U118	0IPRPAD024A	"AD8009JRTZ,LF ANALOG DEVICE"
		U119	0ISTLFA058A	"74F14SCX FAIRCHILD 14P,SOIC"
		U120	0ISS524202C	S524A40X21(SC70) SAMSUNG ELE
		U121	0IRH765700B	"BA7657F 24P,SOP TP INPUT SIG"

DATE: 2005. 05. 20.				
*S	*AL	LOC. NO.	PART NO.	DESCRIPTION / SPECIFICATION
		U122	0ISTL00026A	"MC14066BDR2G,LF ON SEMI 14P,"
		U123	0ISTLFA058A	"74F14SCX FAIRCHILD 14P,SOIC"
		U124	0ISTLFA058A	"74F14SCX FAIRCHILD 14P,SOIC"
		U201	0ISO204000A	"CXA2040AQ 32P,QFP BK IIC BUS"
		U203	0ISS780500H	"KA78M05-R 3P,D-PAK TP 5V 0.5"
		U204	0IPMGKE036A	KIA78DL09F KEC DPARK R/TP 9V
		U303	0IPRPM3002D	"MST9883C-LF-110 MSTAR 80P,LQ"
		U304	0IPMGNS001E	"LM1117MPX-3.3,NOPB NATIONAL"
		U401	0IMMRHY051B	"HY5DU283222AQP-4,LF HYNIX 10"
		U402	0IPRPGN011E	GM1501H-CF-LF(ESD ENHANCEMEN
		U403	0IZZTSZ716A	STM TSOP 48P 8M FLASH
		U404	0IMMRSS040D	S524A60X51(SC70) SAMSUNG ELE
		U501	0IPRPMN001C	MSP3420G-C12-100 MICRONAS 80
		U502	0IPRPTI036B	"TPA3004D2PHPRG4,LF TEXAS INS"
		U503	0IPRPJR017A	"NJU26901E2 JRC 8P,EMP R/TP D"
		U504	0IPMGFA003B	RC1117S-2.5 FAIRCHILD SOT-22
		U505	0IPRPTI015A	MAX232DR TEXAS INSTRUMENT 16
		U506	0IMCRTI001A	"SN74HCT157DR,LF TEXAS INSTR"
		U522	0ISS780800J	"KA78M08R 3P,D-PAK TP VOL. RE"
		U523	0IPRPN030A	"LM35DZ,NOPB NATIONAL SEMICON"
		U524	0IKE358000P	KIA358F 8P FLP-8 TP OP-AMP D
		U608	0IPMGKE036A	KIA78DL09F KEC DPARK R/TP 9V
		U609	0IPMGSG020A	"LD1117DT18TR,LF SGS-THOMSON"
		U611	0IPMGSG020A	"LD1117DT18TR,LF SGS-THOMSON"
		U612	0IPMGFA003B	RC1117S-2.5 FAIRCHILD SOT-22
		U614	0IPMGNS001E	"LM1117MPX-3.3,NOPB NATIONAL"
		U616	0IPMGNS001E	"LM1117MPX-3.3,NOPB NATIONAL"
		U801	0IPRPN011A	"UPD64012GJ-8EN-A,PB FREE NEC"
		U802	0ISS416162D	K4S161622H-UC80 SAMSUNG ELEC
		U803	0IPMGNS001E	"LM1117MPX-3.3,NOPB NATIONAL"
		U804	0IPMGRH001D	"BA15BC0FP-E2 ROHM 3P,TO252 R"
		U901	0IPRPM7001B	"MDIN-150L,ROHS MIT 256PIN,QF"
		U902	0IMMRSS037F	"K4S643232H-UC60,LF SAMSUNG E"
		U907	0IPMGNS001E	"LM1117MPX-3.3,NOPB NATIONAL"
		U908	0IPMGFA003B	RC1117S-2.5 FAIRCHILD SOT-22
COILs & COREs & FILTERs				
		L511	6140TBZ007E	"SLF12575T-330M3R2,TDK SMD CH"
		L512	6140TBZ007E	"SLF12575T-330M3R2,TDK SMD CH"
		L513	6140TBZ007E	"SLF12575T-330M3R2,TDK SMD CH"
		L514	6140TBZ007E	"SLF12575T-330M3R2,TDK SMD CH"
		L409	6210TCE001P	HB-1S2012-121JT CERATECH 201
		L410	6210TCE001P	HB-1S2012-121JT CERATECH 201
		L613	6210TCE001H	HB-1T2012-301JT CERATEC 2012
		L701	6210TCE001P	HB-1S2012-121JT CERATECH 201
		L702	6210TCE001P	HB-1S2012-121JT CERATECH 201
		L704	6210TCE001P	HB-1S2012-121JT CERATECH 201
		L705	6210TCE001P	HB-1S2012-121JT CERATECH 201
		L706	6210TCE001P	HB-1S2012-121JT CERATECH 201
		L707	6210TCE001P	HB-1S2012-121JT CERATECH 201
		L710	6210TCE001F	HB-1S2012-800JT CERATEC 2012
		L711	6210TCE001F	HB-1S2012-800JT CERATEC 2012
		L712	6210TCE001H	HB-1T2012-301JT CERATEC 2012
		L713	6210TCE001H	HB-1T2012-301JT CERATEC 2012
		L920	6210TCE001F	HB-1S2012-800JT CERATEC 2012
		R905	6210TCE001F	HB-1S2012-800JT CERATEC 2012
		L101	6210TCE001A	HB-1S2012-080JT CERATEC 2012
		L1010	6210TCE001G	HH-1M3216-501 CERATEC 3216MM
		L1012	6210TCE001G	HH-1M3216-501 CERATEC 3216MM
		L103	6210TCE001Y	HB-1H2012-320JT CERATEC 2012
		L104	6210TCE001Y	HB-1H2012-320JT CERATEC 2012

DATE: 2005. 05. 20.				
*S	*AL	LOC. NO.	PART NO.	DESCRIPTION / SPECIFICATION
		L107	6210TCE001Y	HB-1H2012-320JT CERATEC 2012
		L108	6210TCE001A	HB-1S2012-080JT CERATEC 2012
		L109	6210TCE001Y	HB-1H2012-320JT CERATEC 2012
		L110	6210TCE001Y	HB-1H2012-320JT CERATEC 2012
		L111	6210TCE001Y	HB-1H2012-320JT CERATEC 2012
		L112	6210TCE001G	HH-1M3216-501 CERATEC 3216MM
		L113	6210TCE001G	HH-1M3216-501 CERATEC 3216MM
		L114	6210TCE001G	HH-1M3216-501 CERATEC 3216MM
		L115	6210TCE001G	HH-1M3216-501 CERATEC 3216MM
		L201	6210TCE001G	HH-1M3216-501 CERATEC 3216MM
		L204	6210TCE001S	HU-1M2012-121 CERATECH 2012M
		L213	6210TCE001G	HH-1M3216-501 CERATEC 3216MM
		L214	6210TCE001G	HH-1M3216-501 CERATEC 3216MM
		L215	6210TCE001S	HU-1M2012-121 CERATECH 2012M
		L216	6210TCE001S	HU-1M2012-121 CERATECH 2012M
		L307	6210TCE001S	HU-1M2012-121 CERATECH 2012M
		L308	6210TCE001S	HU-1M2012-121 CERATECH 2012M
		L309	6210TCE001S	HU-1M2012-121 CERATECH 2012M
		L401	6210TCE001Y	HB-1H2012-320JT CERATEC 2012
		L402	6210TCE001Y	HB-1H2012-320JT CERATEC 2012
		L403	6210TCE001Y	HB-1H2012-320JT CERATEC 2012
		L404	6210TCE001Y	HB-1H2012-320JT CERATEC 2012
		L405	6210TCE001Y	HB-1H2012-320JT CERATEC 2012
		L406	6210TCE001Y	HB-1H2012-320JT CERATEC 2012
		L407	6210TCE001Y	HB-1H2012-320JT CERATEC 2012
		L408	6210TCE001Y	HB-1H2012-320JT CERATEC 2012
		L501	6210TCE001G	HH-1M3216-501 CERATEC 3216MM
		L502	6210TCE001G	HH-1M3216-501 CERATEC 3216MM
		L503	6210TCE001G	HH-1M3216-501 CERATEC 3216MM
		L504	6210TCE001G	HH-1M3216-501 CERATEC 3216MM
		L505	6210TCE001G	HH-1M3216-501 CERATEC 3216MM
		L506	6210TCE001S	HU-1M2012-121 CERATECH 2012M
		L507	6210TCE001S	HU-1M2012-121 CERATECH 2012M
		L508	6210TCE001S	HU-1M2012-121 CERATECH 2012M
		L509	6210TCE001S	HU-1M2012-121 CERATECH 2012M
		L510	6210TCE001G	HH-1M3216-501 CERATEC 3216MM
		L515	6210TCE001G	HH-1M3216-501 CERATEC 3216MM
		L601	6210TCE001G	HH-1M3216-501 CERATEC 3216MM
		L602	6210TCE001G	HH-1M3216-501 CERATEC 3216MM
		L603	6210TCE001G	HH-1M3216-501 CERATEC 3216MM
		L604	6210TCE001G	HH-1M3216-501 CERATEC 3216MM
		L605	6210TCE001G	HH-1M3216-501 CERATEC 3216MM
		L606	6210TCE001G	HH-1M3216-501 CERATEC 3216MM
		L609	6210TCE001G	HH-1M3216-501 CERATEC 3216MM
		L610	6210TCE001G	HH-1M3216-501 CERATEC 3216MM
		L614	6210TCE001G	HH-1M3216-501 CERATEC 3216MM
		L615	6210TCE001G	HH-1M3216-501 CERATEC 3216MM
		L616	6210TCE001G	HH-1M3216-501 CERATEC 3216MM
		L617	6210TCE001G	HH-1M3216-501 CERATEC 3216MM
		L618	6210TCE001G	HH-1M3216-501 CERATEC 3216MM
		L619	6210TCE001G	HH-1M3216-501 CERATEC 3216MM
		L620	6210TCE001G	HH-1M3216-501 CERATEC 3216MM
		L621	6210TCE001G	HH-1M3216-501 CERATEC 3216MM
		L624	6210TCE001G	HH-1M3216-501 CERATEC 3216MM
		L625	6210TCE001G	HH-1M3216-501 CERATEC 3216MM
		L801	6210TCE001Z	HH-1M2012-600JT CERATEC R/TP
		L802	6210TCE001S	HU-1M2012-121 CERATECH 2012M
		L803	6210TCE001S	HU-1M2012-121 CERATECH 2012M
		L804	6210TCE001S	HU-1M2012-121 CERATECH 2012M
		L901	6210TCE001G	HH-1M3216-501 CERATEC 3216MM
		L902	6210TCE001G	HH-1M3216-501 CERATEC 3216MM
		L903	6210TCE001G	HH-1M3216-501 CERATEC 3216MM

DATE: 2005. 05. 20.				
*S	*AL	LOC. NO.	PART NO.	DESCRIPTION / SPECIFICATION
		L904	6210TCE001G	HH-1M3216-501 CERATEC 3216MM
		L905	6210TCE001G	HH-1M3216-501 CERATEC 3216MM
		L921	6210TCE001G	HH-1M3216-501 CERATEC 3216MM
TRANSISTOR				
		Q1001	0TR102009AJ	KRC102S NPN SOT-23 TP KEC
		Q1002	0TR102009AJ	KRC102S NPN SOT-23 TP KEC
		Q101	0TR162309CA	KSC1623 TP SAMSUNG SOT23 NP
		Q201	0TR387500AA	CHIP 2SC3875S(ALY) BK KEC -
		Q202	0TR150400BA	CHIP 2SA1504S(ASY) BK KEC -
		Q203	0TR390409AE	FAIRCHILD KST3904(LGEMTF) TP
		Q204	0TR390409AE	FAIRCHILD KST3904(LGEMTF) TP
		Q205	0TR387500AA	CHIP 2SC3875S(ALY) BK KEC -
		Q206	0TR387500AA	CHIP 2SC3875S(ALY) BK KEC -
		Q207	0TR150400BA	CHIP 2SA1504S(ASY) BK KEC -
		Q209	0TR387500AA	CHIP 2SC3875S(ALY) BK KEC -
		Q210	0TR150400BA	CHIP 2SA1504S(ASY) BK KEC -
		Q211	0TR387500AA	CHIP 2SC3875S(ALY) BK KEC -
		Q212	0TR150400BA	CHIP 2SA1504S(ASY) BK KEC -
		Q401	0TR162309CA	KSC1623 TP SAMSUNG SOT23 NP
		Q402	0TR162309CA	KSC1623 TP SAMSUNG SOT23 NP
		Q403	0TR162309CA	KSC1623 TP SAMSUNG SOT23 NP
		Q405	0TR162309CA	KSC1623 TP SAMSUNG SOT23 NP
		Q406	0TR162309CA	KSC1623 TP SAMSUNG SOT23 NP
		Q407	0TR162309CA	KSC1623 TP SAMSUNG SOT23 NP
		Q501	0TR162309CA	KSC1623 TP SAMSUNG SOT23 NP
		Q502	0TR162309CA	KSC1623 TP SAMSUNG SOT23 NP
		Q503	0TR162309CA	KSC1623 TP SAMSUNG SOT23 NP
		Q504	0TR162309CA	KSC1623 TP SAMSUNG SOT23 NP
		Q505	0TR162309CA	KSC1623 TP SAMSUNG SOT23 NP
		Q510	0TR390609FA	KST3906-MTF TP SAMSUNG SOT2
		Q601	0TR162309CA	KSC1623 TP SAMSUNG SOT23 NP
		Q602	0TR162309CA	KSC1623 TP SAMSUNG SOT23 NP
		U1002	0TFIR80016A	INTERNATIONAL RECTIFIER IRF7
		U601	0TFV180067A	SI3865BDV(E3) VISHAY R/TP TS
		U602	0TFV180067A	SI3865BDV(E3) VISHAY R/TP TS
		U603	0TFIR80009D	"IRF7316TRPBF,LF INTERNATIONA"
		U607	0TFFC80009A	FAIRCHILD FDC6326L R/TP SOT-
RESISTORS				
		L708	0RH0000D622	0 OHM 1 / 10 W 2012 5.00% D
		L709	0RH0000D622	0 OHM 1 / 10 W 2012 5.00% D
		R100	0RJ0000D677	0 OHM 1/10 W 5% 1608 R/TP
		R1001	0RJ0000D677	0 OHM 1/10 W 5% 1608 R/TP
		R1002	0RJ0000D677	0 OHM 1/10 W 5% 1608 R/TP
		R1003	0RJ0000D677	0 OHM 1/10 W 5% 1608 R/TP
		R1004	0RJ0000D677	0 OHM 1/10 W 5% 1608 R/TP
		R101	0RJ0000D677	0 OHM 1/10 W 5% 1608 R/TP
		R102	0RJ0752D677	75 OHM 1/10 W 5% 1608 R/TP
		R103	0RJ0752D677	75 OHM 1/10 W 5% 1608 R/TP
		R1034	0RJ1000D677	100 OHM 1/10 W 5% 1608 R/TP
		R1035	0RJ1000D677	100 OHM 1/10 W 5% 1608 R/TP
		R1036	0RJ1000D677	100 OHM 1/10 W 5% 1608 R/TP
		R1037	0RJ0000D677	0 OHM 1/10 W 5% 1608 R/TP
		R1038	0RJ0000D677	0 OHM 1/10 W 5% 1608 R/TP
		R104	0RJ0752D677	75 OHM 1/10 W 5% 1608 R/TP
		R1042	0RJ1002D677	10K OHM 1/10 W 5% 1608 R/TP
		R1049	0RJ1000D677	100 OHM 1/10 W 5% 1608 R/TP
		R105	0RJ0222D677	22 OHM 1/10 W 5% 1608 R/TP
		R1050	0RJ1000D677	100 OHM 1/10 W 5% 1608 R/TP

DATE: 2005. 05. 20.				
*S	*AL	LOC. NO.	PART NO.	DESCRIPTION / SPECIFICATION
		R1051	0RJ1001D677	1K OHM 1/10 W 5% 1608 R/TP
		R1052	0RJ1002D677	10K OHM 1/10 W 5% 1608 R/TP
		R1053	0RJ1002D677	10K OHM 1/10 W 5% 1608 R/TP
		R1054	0RJ2002D677	20000 OHM 1/10 W 5% 1608 R/T
		R1055	0RH0000D622	0 OHM 1 / 10 W 2012 5.00% D
		R1056	0RH4701D622	4.7K OHM 1 / 10 W 2012 5.00%
		R106	0RJ0222D677	22 OHM 1/10 W 5% 1608 R/TP
		R1068	0RJ1002D677	10K OHM 1/10 W 5% 1608 R/TP
		R1069	0RJ1002D677	10K OHM 1/10 W 5% 1608 R/TP
		R1070	0RJ1002D677	10K OHM 1/10 W 5% 1608 R/TP
		R1071	0RJ1002D677	10K OHM 1/10 W 5% 1608 R/TP
		R1072	0RJ2001D677	2K OHM 1/10 W 5% 1608 R/TP
		R1075	0RJ0000D677	0 OHM 1/10 W 5% 1608 R/TP
		R1076	0RJ0000D677	0 OHM 1/10 W 5% 1608 R/TP
		R1077	0RJ0000D677	0 OHM 1/10 W 5% 1608 R/TP
		R1078	0RJ0000D677	0 OHM 1/10 W 5% 1608 R/TP
		R1079	0RJ0000D677	0 OHM 1/10 W 5% 1608 R/TP
		R108	0RJ4701D677	4.7K OHM 1/10 W 5% 1608 R/TP
		R1080	0RJ0000D677	0 OHM 1/10 W 5% 1608 R/TP
		R109	0RJ0000D677	0 OHM 1/10 W 5% 1608 R/TP
		R1090	0RJ0000D677	0 OHM 1/10 W 5% 1608 R/TP
		R1091	0RJ0000D677	0 OHM 1/10 W 5% 1608 R/TP
		R1092	0RJ0000D677	0 OHM 1/10 W 5% 1608 R/TP
		R1093	0RH0562D622	56 OHM 1 / 10 W 2012 5.00% D
		R110	0RJ0222D677	22 OHM 1/10 W 5% 1608 R/TP
		R113	0RJ0000D677	0 OHM 1/10 W 5% 1608 R/TP
		R114	0RJ1002D677	10K OHM 1/10 W 5% 1608 R/TP
		R116	0RJ0000D677	0 OHM 1/10 W 5% 1608 R/TP
		R117	0RJ0332D677	33 OHM 1/10 W 5% 1608 R/TP
		R118	0RJ1002D677	10K OHM 1/10 W 5% 1608 R/TP
		R119	0RJ0472D677	47 OHM 1/10 W 5% 1608 R/TP
		R120	0RJ0222D677	22 OHM 1/10 W 5% 1608 R/TP
		R121	0RJ0332D677	33 OHM 1/10 W 5% 1608 R/TP
		R122	0RJ0222D677	22 OHM 1/10 W 5% 1608 R/TP
		R124	0RJ0222D677	22 OHM 1/10 W 5% 1608 R/TP
		R125	0RJ0000D677	0 OHM 1/10 W 5% 1608 R/TP
		R126	0RJ0222D677	22 OHM 1/10 W 5% 1608 R/TP
		R127	0RJ0222D677	22 OHM 1/10 W 5% 1608 R/TP
		R128	0RJ0222D677	22 OHM 1/10 W 5% 1608 R/TP
		R129	0RH4703D622	470K OHM 1 / 10 W 2012 5.00%
		R130	0RJ0222D677	22 OHM 1/10 W 5% 1608 R/TP
		R131	0RJ6802D677	68K OHM 1/10 W 5% 1608 R/TP
		R132	0RJ0222D677	22 OHM 1/10 W 5% 1608 R/TP
		R133	0RJ2001D677	2K OHM 1/10 W 5% 1608 R/TP
		R134	0RJ0222D677	22 OHM 1/10 W 5% 1608 R/TP
		R135	0RJ1000D677	100 OHM 1/10 W 5% 1608 R/TP
		R136	0RJ4701D677	4.7K OHM 1/10 W 5% 1608 R/TP
		R137	0RJ4701D677	4.7K OHM 1/10 W 5% 1608 R/TP
		R138	0RJ4701D677	4.7K OHM 1/10 W 5% 1608 R/TP
		R139	0RJ4701D677	4.7K OHM 1/10 W 5% 1608 R/TP
		R140	0RJ4701D677	4.7K OHM 1/10 W 5% 1608 R/TP
		R141	0RJ4701D677	4.7K OHM 1/10 W 5% 1608 R/TP
		R142	0RJ4701D677	4.7K OHM 1/10 W 5% 1608 R/TP
		R143	0RJ4701D677	4.7K OHM 1/10 W 5% 1608 R/TP
		R144	0RJ0000D677	0 OHM 1/10 W 5% 1608 R/TP
		R145	0RJ0000D677	0 OHM 1/10 W 5% 1608 R/TP
		R146	0RJ1002D677	10K OHM 1/10 W 5% 1608 R/TP
		R147	0RJ1002D677	10K OHM 1/10 W 5% 1608 R/TP
		R148	0RJ1002D677	10K OHM 1/10 W 5% 1608 R/TP
		R149	0RJ1002D677	10K OHM 1/10 W 5% 1608 R/TP
		R150	0RJ4701D677	4.7K OHM 1/10 W 5% 1608 R/TP
		R151	0RJ1002D677	10K OHM 1/10 W 5% 1608 R/TP

DATE: 2005. 05. 20.				
*S	*AL	LOC. NO.	PART NO.	DESCRIPTION / SPECIFICATION
		R152	0RJ8200D677	820 OHM 1/10 W 5% 1608 R/TP
		R153	0RJ0332D677	33 OHM 1/10 W 5% 1608 R/TP
		R154	0RJ0332D677	33 OHM 1/10 W 5% 1608 R/TP
		R155	0RJ0332D677	33 OHM 1/10 W 5% 1608 R/TP
		R156	0RJ0332D677	33 OHM 1/10 W 5% 1608 R/TP
		R158	0RJ0000D677	0 OHM 1/10 W 5% 1608 R/TP
		R160	0RJ0000D677	0 OHM 1/10 W 5% 1608 R/TP
		R161	0RJ2002D677	20000 OHM 1/10 W 5% 1608 R/T
		R162	0RJ0222D677	22 OHM 1/10 W 5% 1608 R/TP
		R163	0RJ0752D477	75 OHM 1/10 W 1% 1608 R/TP
		R165	0RJ3300D477	330 OHM 1/10 W 1% 1608 R/TP
		R166	0RJ3300D477	330 OHM 1/10 W 1% 1608 R/TP
		R167	0RJ2002D677	20000 OHM 1/10 W 5% 1608 R/T
		R168	0RJ0222D677	22 OHM 1/10 W 5% 1608 R/TP
		R169	0RJ0752D477	75 OHM 1/10 W 1% 1608 R/TP
		R171	0RJ3300D477	330 OHM 1/10 W 1% 1608 R/TP
		R172	0RJ3300D477	330 OHM 1/10 W 1% 1608 R/TP
		R173	0RJ2002D677	20000 OHM 1/10 W 5% 1608 R/T
		R174	0RJ0222D677	22 OHM 1/10 W 5% 1608 R/TP
		R175	0RJ0752D477	75 OHM 1/10 W 1% 1608 R/TP
		R177	0RJ3300D477	330 OHM 1/10 W 1% 1608 R/TP
		R178	0RJ3300D477	330 OHM 1/10 W 1% 1608 R/TP
		R179	0RJ1000D677	100 OHM 1/10 W 5% 1608 R/TP
		R180	0RJ1000D677	100 OHM 1/10 W 5% 1608 R/TP
		R181	0RJ0752D677	75 OHM 1/10 W 5% 1608 R/TP
		R182	0RJ0752D677	75 OHM 1/10 W 5% 1608 R/TP
		R183	0RJ0752D677	75 OHM 1/10 W 5% 1608 R/TP
		R187	0RJ0472D677	47 OHM 1/10 W 5% 1608 R/TP
		R188	0RJ1002D677	10K OHM 1/10 W 5% 1608 R/TP
		R189	0RJ0000D677	0 OHM 1/10 W 5% 1608 R/TP
		R190	0RJ0000D677	0 OHM 1/10 W 5% 1608 R/TP
		R191	0RJ1002D677	10K OHM 1/10 W 5% 1608 R/TP
		R192	0RJ4701D677	4.7K OHM 1/10 W 5% 1608 R/TP
		R193	0RJ0222D677	22 OHM 1/10 W 5% 1608 R/TP
		R194	0RJ0000D677	0 OHM 1/10 W 5% 1608 R/TP
		R196	0RJ0222D677	22 OHM 1/10 W 5% 1608 R/TP
		R197	0RJ0222D677	22 OHM 1/10 W 5% 1608 R/TP
		R198	0RJ1002D677	10K OHM 1/10 W 5% 1608 R/TP
		R199	0RJ1002D677	10K OHM 1/10 W 5% 1608 R/TP
		R206	0RJ2200D677	220 OHM 1/10 W 5% 1608 R/TP
		R218	0RJ2200D677	220 OHM 1/10 W 5% 1608 R/TP
		R221	0RJ2200D677	220 OHM 1/10 W 5% 1608 R/TP
		R223	0RJ2200D677	220 OHM 1/10 W 5% 1608 R/TP
		R227	0RJ6802D677	68K OHM 1/10 W 5% 1608 R/TP
		R228	0RJ1000D677	100 OHM 1/10 W 5% 1608 R/TP
		R229	0RJ1000D677	100 OHM 1/10 W 5% 1608 R/TP
		R232	0RJ1002D677	10K OHM 1/10 W 5% 1608 R/TP
		R236	0RJ1000D677	100 OHM 1/10 W 5% 1608 R/TP
		R237	0RJ1002D677	10K OHM 1/10 W 5% 1608 R/TP
		R238	0RJ1000D677	100 OHM 1/10 W 5% 1608 R/TP
		R239	0RJ2000D677	200 OHM 1/10 W 5% 1608 R/TP
		R240	0RJ4700D677	470 OHM 1/10 W 5% 1608 R/TP
		R241	0RJ4700D677	470 OHM 1/10 W 5% 1608 R/TP
		R243	0RJ3000D677	300 OHM 1/10 W 5% 1608 R/TP
		R250	0RJ3000D677	300 OHM 1/10 W 5% 1608 R/TP
		R251	0RJ3000D677	300 OHM 1/10 W 5% 1608 R/TP
		R270	0RJ2000D677	200 OHM 1/10 W 5% 1608 R/TP
		R271	0RJ3000D677	300 OHM 1/10 W 5% 1608 R/TP
		R272	0RJ1002D677	10K OHM 1/10 W 5% 1608 R/TP
		R273	0RJ1000D677	100 OHM 1/10 W 5% 1608 R/TP
		R274	0RJ1002D677	10K OHM 1/10 W 5% 1608 R/TP
		R275	0RJ1000D677	100 OHM 1/10 W 5% 1608 R/TP

DATE: 2005. 05. 20.				
*S	*AL	LOC. NO.	PART NO.	DESCRIPTION / SPECIFICATION
		R276	0RJ4700D677	470 OHM 1/10 W 5% 1608 R/TP
		R277	0RJ4700D677	470 OHM 1/10 W 5% 1608 R/TP
		R280	0RJ1002D677	10K OHM 1/10 W 5% 1608 R/TP
		R281	0RJ1000D677	100 OHM 1/10 W 5% 1608 R/TP
		R282	0RJ1002D677	10K OHM 1/10 W 5% 1608 R/TP
		R283	0RJ1000D677	100 OHM 1/10 W 5% 1608 R/TP
		R284	0RJ4700D677	470 OHM 1/10 W 5% 1608 R/TP
		R285	0RJ4700D677	470 OHM 1/10 W 5% 1608 R/TP
		R288	0RJ0000D677	0 OHM 1/10 W 5% 1608 R/TP
		R289	0RJ0000D677	0 OHM 1/10 W 5% 1608 R/TP
		R290	0RJ0000D677	0 OHM 1/10 W 5% 1608 R/TP
		R317	0RJ1500D677	150 OHM 1/10 W 5% 1608 R/TP
		R318	0RJ0752D477	75 OHM 1/10 W 1% 1608 R/TP
		R319	0RJ1500D677	150 OHM 1/10 W 5% 1608 R/TP
		R320	0RJ0752D477	75 OHM 1/10 W 1% 1608 R/TP
		R322	0RJ0752D677	75 OHM 1/10 W 5% 1608 R/TP
		R323	0RJ1500D677	150 OHM 1/10 W 5% 1608 R/TP
		R325	0RJ0222D677	22 OHM 1/10 W 5% 1608 R/TP
		R326	0RJ0222D677	22 OHM 1/10 W 5% 1608 R/TP
		R327	0RJ1001D677	1K OHM 1/10 W 5% 1608 R/TP
		R328	0RJ1001D677	1K OHM 1/10 W 5% 1608 R/TP
		R332	0RJ1001D677	1K OHM 1/10 W 5% 1608 R/TP
		R333	0RJ1001D677	1K OHM 1/10 W 5% 1608 R/TP
		R334	0RJ1001D677	1K OHM 1/10 W 5% 1608 R/TP
		R344	0RJ0000D677	0 OHM 1/10 W 5% 1608 R/TP
		R346	0RJ0000D677	0 OHM 1/10 W 5% 1608 R/TP
		R347	0RH0000D622	0 OHM 1 / 10 W 2012 5.00% D
		R400	0RJ1000D677	100 OHM 1/10 W 5% 1608 R/TP
		R401	0RJ1002D477	10K OHM 1/10 W 1% 1608 R/TP
		R402	0RJ1002D477	10K OHM 1/10 W 1% 1608 R/TP
		R403	0RJ1500D677	150 OHM 1/10 W 5% 1608 R/TP
		R408	0RJ2202D677	22K OHM 1/10 W 5% 1608 R/TP
		R409	0RH0000D622	0 OHM 1 / 10 W 2012 5.00% D
		R410	0RJ2700D477	270 OHM 1/10 W 1% 1608 R/TP
		R411	0RJ0222D677	22 OHM 1/10 W 5% 1608 R/TP
		R412	0RJ0222D677	22 OHM 1/10 W 5% 1608 R/TP
		R413	0RJ0222D677	22 OHM 1/10 W 5% 1608 R/TP
		R414	0RJ0000D677	0 OHM 1/10 W 5% 1608 R/TP
		R415	0RJ0000D677	0 OHM 1/10 W 5% 1608 R/TP
		R416	0RJ1000D677	100 OHM 1/10 W 5% 1608 R/TP
		R417	0RJ1000D677	100 OHM 1/10 W 5% 1608 R/TP
		R418	0RH0000D622	0 OHM 1 / 10 W 2012 5.00% D
		R419	0RH0000D622	0 OHM 1 / 10 W 2012 5.00% D
		R420	0RH0000D622	0 OHM 1 / 10 W 2012 5.00% D
		R422	0RJ0000D677	0 OHM 1/10 W 5% 1608 R/TP
		R423	0RJ1002D677	10K OHM 1/10 W 5% 1608 R/TP
		R424	0RJ1002D677	10K OHM 1/10 W 5% 1608 R/TP
		R425	0RJ1002D677	10K OHM 1/10 W 5% 1608 R/TP
		R426	0RH2701D622	2.7K OHM 1 / 10 W 2012 5.00%
		R427	0RJ0000D677	0 OHM 1/10 W 5% 1608 R/TP
		R428	0RH0000D622	0 OHM 1 / 10 W 2012 5.00% D
		R430	0RH1002D622	10K OHM 1 / 10 W 2012 5.00%
		R431	0RH3301D622	3.3K OHM 1 / 10 W 2012 5.00%
		R432	0RJ1002D677	10K OHM 1/10 W 5% 1608 R/TP
		R433	0RJ1001D677	1K OHM 1/10 W 5% 1608 R/TP
		R434	0RJ0000D677	0 OHM 1/10 W 5% 1608 R/TP
		R435	0RJ0000D677	0 OHM 1/10 W 5% 1608 R/TP
		R436	0RJ0000D677	0 OHM 1/10 W 5% 1608 R/TP
		R437	0RJ0000D677	0 OHM 1/10 W 5% 1608 R/TP
		R438	0RJ0000D677	0 OHM 1/10 W 5% 1608 R/TP
		R440	0RH3301D622	3.3K OHM 1 / 10 W 2012 5.00%
		R441	0RJ1002D677	10K OHM 1/10 W 5% 1608 R/TP

DATE: 2005. 05. 20.				
*S	*AL	LOC. NO.	PART NO.	DESCRIPTION / SPECIFICATION
		R442	0RJ1001D677	1K OHM 1/10 W 5% 1608 R/TP
		R443	0RJ4700D677	470 OHM 1/10 W 5% 1608 R/TP
		R444	0RH0000D622	0 OHM 1 / 10 W 2012 5.00% D
		R446	0RJ2202D677	22K OHM 1/10 W 5% 1608 R/TP
		R447	0RJ1002D677	10K OHM 1/10 W 5% 1608 R/TP
		R448	0RJ1002D677	10K OHM 1/10 W 5% 1608 R/TP
		R449	0RJ0000D677	0 OHM 1/10 W 5% 1608 R/TP
		R450	0RJ4700D677	470 OHM 1/10 W 5% 1608 R/TP
		R451	0RJ0000D677	0 OHM 1/10 W 5% 1608 R/TP
		R452	0RH0000D622	0 OHM 1 / 10 W 2012 5.00% D
		R453	0RJ4700D677	470 OHM 1/10 W 5% 1608 R/TP
		R454	0RH0000D622	0 OHM 1 / 10 W 2012 5.00% D
		R455	0RH0000D622	0 OHM 1 / 10 W 2012 5.00% D
		R456	0RH2201D622	2.2K OHM 1 / 10 W 2012 5.00%
		R457	0RJ3302D677	33K OHM 1/10 W 5% 1608 R/TP
		R459	0RH2201D622	2.2K OHM 1 / 10 W 2012 5.00%
		R460	0RJ2201D677	2200 OHM 1/10 W 5% 1608 R/TP
		R461	0RJ2201D677	2200 OHM 1/10 W 5% 1608 R/TP
		R462	0RJ0000D677	0 OHM 1/10 W 5% 1608 R/TP
		R463	0RJ0332D677	33 OHM 1/10 W 5% 1608 R/TP
		R464	0RJ3301D677	3.3K OHM 1/10 W 5% 1608 R/TP
		R467	0RJ0000D677	0 OHM 1/10 W 5% 1608 R/TP
		R469	0RH0000D622	0 OHM 1 / 10 W 2012 5.00% D
		R470	0RH0000D622	0 OHM 1 / 10 W 2012 5.00% D
		R471	0RH0000D622	0 OHM 1 / 10 W 2012 5.00% D
		R473	0RJ4700D677	470 OHM 1/10 W 5% 1608 R/TP
		R474	0RJ0000D677	0 OHM 1/10 W 5% 1608 R/TP
		R475	0RJ0000D677	0 OHM 1/10 W 5% 1608 R/TP
		R477	0RJ0000D677	0 OHM 1/10 W 5% 1608 R/TP
		R478	0RH0000D622	0 OHM 1 / 10 W 2012 5.00% D
		R479	0RJ0000D677	0 OHM 1/10 W 5% 1608 R/TP
		R480	0RH0000D622	0 OHM 1 / 10 W 2012 5.00% D
		R481	0RH0000D622	0 OHM 1 / 10 W 2012 5.00% D
		R482	0RH1000D622	100 OHM 1 / 10 W 2012 5.00%
		R483	0RH0000D622	0 OHM 1 / 10 W 2012 5.00% D
		R488	0RH0000D622	0 OHM 1 / 10 W 2012 5.00% D
		R489	0RH0000D622	0 OHM 1 / 10 W 2012 5.00% D
		R494	0RJ1000D677	100 OHM 1/10 W 5% 1608 R/TP
		R495	0RJ1000D677	100 OHM 1/10 W 5% 1608 R/TP
		R496	0RJ2201D677	2200 OHM 1/10 W 5% 1608 R/TP
		R497	0RJ2201D677	2200 OHM 1/10 W 5% 1608 R/TP
		R5001	0RJ4701D677	4.7K OHM 1/10 W 5% 1608 R/TP
		R5002	0RJ4701D677	4.7K OHM 1/10 W 5% 1608 R/TP
		R5003	0RJ0000D677	0 OHM 1/10 W 5% 1608 R/TP
		R5004	0RJ0000D677	0 OHM 1/10 W 5% 1608 R/TP
		R5005	0RJ4701D677	4.7K OHM 1/10 W 5% 1608 R/TP
		R5006	0RJ1001D677	1K OHM 1/10 W 5% 1608 R/TP
		R5007	0RJ1001D677	1K OHM 1/10 W 5% 1608 R/TP
		R5008	0RJ0000D677	0 OHM 1/10 W 5% 1608 R/TP
		R501	0RJ1001D677	1K OHM 1/10 W 5% 1608 R/TP
		R5010	0RJ0000D677	0 OHM 1/10 W 5% 1608 R/TP
		R5011	0RJ0000D677	0 OHM 1/10 W 5% 1608 R/TP
		R5013	0RJ0000D677	0 OHM 1/10 W 5% 1608 R/TP
		R5014	0RJ0000D677	0 OHM 1/10 W 5% 1608 R/TP
		R5015	0RJ1002D677	10K OHM 1/10 W 5% 1608 R/TP
		R5016	0RJ1001D677	1K OHM 1/10 W 5% 1608 R/TP
		R5017	0RJ0000D677	0 OHM 1/10 W 5% 1608 R/TP
		R5019	0RJ0000D677	0 OHM 1/10 W 5% 1608 R/TP
		R502	0RJ1001D677	1K OHM 1/10 W 5% 1608 R/TP
		R5023	0RJ6801D477	6.8K OHM 1/10 W 1% 1608 R/TP
		R5024	0RH1000D622	100 OHM 1 / 10 W 2012 5.00%
		R5025	0RJ3901D477	3.9K OHM 1/10 W 1% 1608 R/TP

DATE: 2005. 05. 20.				
*S	*AL	LOC. NO.	PART NO.	DESCRIPTION / SPECIFICATION
		R503	0RJ1001D677	1K OHM 1/10 W 5% 1608 R/TP
		R504	0RJ1001D677	1K OHM 1/10 W 5% 1608 R/TP
		R505	0RJ1001D677	1K OHM 1/10 W 5% 1608 R/TP
		R506	0RJ1001D677	1K OHM 1/10 W 5% 1608 R/TP
		R508	0RJ3301D677	3.3K OHM 1/10 W 5% 1608 R/TP
		R509	0RJ1001D677	1K OHM 1/10 W 5% 1608 R/TP
		R510	0RJ0000D677	0 OHM 1/10 W 5% 1608 R/TP
		R511	0RJ1000D677	100 OHM 1/10 W 5% 1608 R/TP
		R512	0RJ1001D677	1K OHM 1/10 W 5% 1608 R/TP
		R514	0RJ1001D677	1K OHM 1/10 W 5% 1608 R/TP
		R519	0RJ0000D677	0 OHM 1/10 W 5% 1608 R/TP
		R521	0RJ3302D677	33K OHM 1/10 W 5% 1608 R/TP
		R522	0RJ1001D677	1K OHM 1/10 W 5% 1608 R/TP
		R523	0RJ2002D677	20000 OHM 1/10 W 5% 1608 R/T
		R524	0RJ3302D677	33K OHM 1/10 W 5% 1608 R/TP
		R526	0RJ2002D677	20000 OHM 1/10 W 5% 1608 R/T
		R527	0RJ1203D677	120K OHM 1/10 W 5% 1608 R/TP
		R528	0RJ1203D677	120K OHM 1/10 W 5% 1608 R/TP
		R529	0RJ1002D677	10K OHM 1/10 W 5% 1608 R/TP
		R530	0RJ1001D677	1K OHM 1/10 W 5% 1608 R/TP
		R531	0RJ1001D677	1K OHM 1/10 W 5% 1608 R/TP
		R534	0RJ2402D677	24K OHM 1/10 W 5% 1608 R/TP
		R535	0RJ2002D477	20K OHM 1/10 W 1% 1608 R/TP
		R536	0RJ0000D677	0 OHM 1/10 W 5% 1608 R/TP
		R537	0RJ2402D677	24K OHM 1/10 W 5% 1608 R/TP
		R538	0RJ2402D677	24K OHM 1/10 W 5% 1608 R/TP
		R539	0RJ3302D477	33K OHM 1/10 W 1% 1608 R/TP
		R540	0RH0000D622	0 OHM 1 / 10 W 2012 5.00% D
		R541	0RJ1000D677	100 OHM 1/10 W 5% 1608 R/TP
		R542	0RH0000D622	0 OHM 1 / 10 W 2012 5.00% D
		R543	0RH0000D622	0 OHM 1 / 10 W 2012 5.00% D
		R544	0RJ1000D677	100 OHM 1/10 W 5% 1608 R/TP
		R545	0RJ3302D677	33K OHM 1/10 W 5% 1608 R/TP
		R546	0RH0000D622	0 OHM 1 / 10 W 2012 5.00% D
		R550	0RJ2002D677	20000 OHM 1/10 W 5% 1608 R/T
		R551	0RJ3302D677	33K OHM 1/10 W 5% 1608 R/TP
		R552	0RJ2702D677	27K OHM 1/10 W 5% 1608 R/TP
		R554	0RJ2002D677	20000 OHM 1/10 W 5% 1608 R/T
		R556	0RJ1001D677	1K OHM 1/10 W 5% 1608 R/TP
		R557	0RJ1001D677	1K OHM 1/10 W 5% 1608 R/TP
		R558	0RJ1000D677	100 OHM 1/10 W 5% 1608 R/TP
		R559	0RJ1000D677	100 OHM 1/10 W 5% 1608 R/TP
		R560	0RJ1000D677	100 OHM 1/10 W 5% 1608 R/TP
		R561	0RJ1000D677	100 OHM 1/10 W 5% 1608 R/TP
		R562	0RJ0000D677	0 OHM 1/10 W 5% 1608 R/TP
		R565	0RJ0000D677	0 OHM 1/10 W 5% 1608 R/TP
		R579	0RJ1002D677	10K OHM 1/10 W 5% 1608 R/TP
		R580	0RJ1002D677	10K OHM 1/10 W 5% 1608 R/TP
		R581	0RJ1002D677	10K OHM 1/10 W 5% 1608 R/TP
		R583	0RJ1002D677	10K OHM 1/10 W 5% 1608 R/TP
		R585	0RJ1002D677	10K OHM 1/10 W 5% 1608 R/TP
		R586	0RJ1002D677	10K OHM 1/10 W 5% 1608 R/TP
		R587	0RJ1002D677	10K OHM 1/10 W 5% 1608 R/TP
		R588	0RJ1002D677	10K OHM 1/10 W 5% 1608 R/TP
		R592	0RJ1002D677	10K OHM 1/10 W 5% 1608 R/TP
		R593	0RJ1002D677	10K OHM 1/10 W 5% 1608 R/TP
		R595	0RJ1002D677	10K OHM 1/10 W 5% 1608 R/TP
		R597	0RJ1002D677	10K OHM 1/10 W 5% 1608 R/TP
		R602	0RJ0000D677	0 OHM 1/10 W 5% 1608 R/TP
		R603	0RJ3301D677	3.3K OHM 1/10 W 5% 1608 R/TP
		R604	0RJ1002D677	10K OHM 1/10 W 5% 1608 R/TP
		R605	0RJ2201D677	2200 OHM 1/10 W 5% 1608 R/TP

DATE: 2005. 05. 20.				
*S	*AL	LOC. NO.	PART NO.	DESCRIPTION / SPECIFICATION
		R607	0RJ4701D677	4.7K OHM 1/10 W 5% 1608 R/TP
		R613	0RJ2202D677	22K OHM 1/10 W 5% 1608 R/TP
		R615	0RJ1500D677	150 OHM 1/10 W 5% 1608 R/TP
		R616	0RJ1000D677	100 OHM 1/10 W 5% 1608 R/TP
		R618	0RJ0000D677	0 OHM 1/10 W 5% 1608 R/TP
		R625	0RJ4701D677	4.7K OHM 1/10 W 5% 1608 R/TP
		R627	0RJ0222D677	22 OHM 1/10 W 5% 1608 R/TP
		R634	0RJ1001D677	1K OHM 1/10 W 5% 1608 R/TP
		R635	0RJ0000D677	0 OHM 1/10 W 5% 1608 R/TP
		R636	0RJ1000D677	100 OHM 1/10 W 5% 1608 R/TP
		R638	0RJ0000D677	0 OHM 1/10 W 5% 1608 R/TP
		R639	0RJ2202D677	22K OHM 1/10 W 5% 1608 R/TP
		R640	0RJ5600D677	560 OHM 1/10 W 5% 1608 R/TP
		R641	0RJ2202D677	22K OHM 1/10 W 5% 1608 R/TP
		R642	0RJ5600D677	560 OHM 1/10 W 5% 1608 R/TP
		R701	0RJ0000D677	0 OHM 1/10 W 5% 1608 R/TP
		R702	0RJ4703D677	470K OHM 1/10 W 5% 1608 R/TP
		R703	0RJ4703D677	470K OHM 1/10 W 5% 1608 R/TP
		R704	0RJ0000D677	0 OHM 1/10 W 5% 1608 R/TP
		R705	0RJ4703D677	470K OHM 1/10 W 5% 1608 R/TP
		R706	0RJ4703D677	470K OHM 1/10 W 5% 1608 R/TP
		R707	0RJ0752D677	75 OHM 1/10 W 5% 1608 R/TP
		R708	0RJ0752D677	75 OHM 1/10 W 5% 1608 R/TP
		R709	0RJ4703D677	470K OHM 1/10 W 5% 1608 R/TP
		R710	0RJ4703D677	470K OHM 1/10 W 5% 1608 R/TP
		R711	0RJ0752D677	75 OHM 1/10 W 5% 1608 R/TP
		R712	0RJ0822D677	82 OHM 1/10 W 5% 1608 R/TP
		R713	0RJ0752D677	75 OHM 1/10 W 5% 1608 R/TP
		R714	0RJ0472D677	47 OHM 1/10 W 5% 1608 R/TP
		R715	0RJ0822D677	82 OHM 1/10 W 5% 1608 R/TP
		R716	0RJ0752D677	75 OHM 1/10 W 5% 1608 R/TP
		R717	0RJ0752D677	75 OHM 1/10 W 5% 1608 R/TP
		R718	0RJ0752D677	75 OHM 1/10 W 5% 1608 R/TP
		R719	0RJ0822D677	82 OHM 1/10 W 5% 1608 R/TP
		R720	0RJ0752D677	75 OHM 1/10 W 5% 1608 R/TP
		R721	0RJ0222D677	22 OHM 1/10 W 5% 1608 R/TP
		R722	0RJ0752D677	75 OHM 1/10 W 5% 1608 R/TP
		R723	0RJ0752D677	75 OHM 1/10 W 5% 1608 R/TP
		R724	0RJ0752D677	75 OHM 1/10 W 5% 1608 R/TP
		R725	0RJ0222D677	22 OHM 1/10 W 5% 1608 R/TP
		R726	0RJ0222D677	22 OHM 1/10 W 5% 1608 R/TP
		R727	0RJ1001D677	1K OHM 1/10 W 5% 1608 R/TP
		R728	0RJ1001D677	1K OHM 1/10 W 5% 1608 R/TP
		R729	0RJ5600D677	560 OHM 1/10 W 5% 1608 R/TP
		R730	0RJ5600D677	560 OHM 1/10 W 5% 1608 R/TP
		R731	0RJ5600D677	560 OHM 1/10 W 5% 1608 R/TP
		R733	0RJ1002D677	10K OHM 1/10 W 5% 1608 R/TP
		R734	0RJ1002D677	10K OHM 1/10 W 5% 1608 R/TP
		R735	0RJ0752D677	75 OHM 1/10 W 5% 1608 R/TP
		R808	0RJ1000D677	100 OHM 1/10 W 5% 1608 R/TP
		R809	0RJ1000D677	100 OHM 1/10 W 5% 1608 R/TP
		R810	0RJ1000D677	100 OHM 1/10 W 5% 1608 R/TP
		R811	0RJ4701D677	4.7K OHM 1/10 W 5% 1608 R/TP
		R812	0RJ1000D677	100 OHM 1/10 W 5% 1608 R/TP
		R813	0RJ1000D677	100 OHM 1/10 W 5% 1608 R/TP
		R814	0RJ1000D677	100 OHM 1/10 W 5% 1608 R/TP
		R816	0RJ1000D677	100 OHM 1/10 W 5% 1608 R/TP
		R817	0RH4701D622	4.7K OHM 1 / 10 W 2012 5.00%
		R818	0RJ1000D677	100 OHM 1/10 W 5% 1608 R/TP
		R819	0RJ1000D677	100 OHM 1/10 W 5% 1608 R/TP
		R822	0RH1000D622	100 OHM 1 / 10 W 2012 5.00%
		R823	0RJ1000D677	100 OHM 1/10 W 5% 1608 R/TP

DATE: 2005. 05. 20.				
*S	*AL	LOC. NO.	PART NO.	DESCRIPTION / SPECIFICATION
		R901	0RJ0222D677	22 OHM 1/10 W 5% 1608 R/TP
		R906	0RJ0222D677	22 OHM 1/10 W 5% 1608 R/TP
		R907	0RJ0222D677	22 OHM 1/10 W 5% 1608 R/TP
		R908	0RJ0332D677	33 OHM 1/10 W 5% 1608 R/TP
		R909	0RJ4701D677	4.7K OHM 1/10 W 5% 1608 R/TP
		R910	0RJ4701D677	4.7K OHM 1/10 W 5% 1608 R/TP
		R911	0RJ4701D677	4.7K OHM 1/10 W 5% 1608 R/TP
		R912	0RJ1001D677	1K OHM 1/10 W 5% 1608 R/TP
		R913	0RH1000D622	100 OHM 1 / 10 W 2012 5.00%
		R914	0RH1000D622	100 OHM 1 / 10 W 2012 5.00%
		R915	0RJ3300D677	330 OHM 1/10 W 5% 1608 R/TP
		R916	0RJ3300D677	330 OHM 1/10 W 5% 1608 R/TP
		R917	0RJ3300D677	330 OHM 1/10 W 5% 1608 R/TP
		R918	0RJ3300D677	330 OHM 1/10 W 5% 1608 R/TP
		R919	0RJ3300D677	330 OHM 1/10 W 5% 1608 R/TP
		R956	0RJ1001D677	1K OHM 1/10 W 5% 1608 R/TP
		R957	0RJ3300D677	330 OHM 1/10 W 5% 1608 R/TP
		R960	0RJ3300D677	330 OHM 1/10 W 5% 1608 R/TP
		R961	0RH3300D622	330 OHM 1 / 10 W 2012 5.00%
		R962	0RJ1000D677	100 OHM 1/10 W 5% 1608 R/TP
		R963	0RJ1005D677	10M OHM 1/10 W 5% 1608 R/TP
		R965	0RJ1000D677	100 OHM 1/10 W 5% 1608 R/TP
		R966	0RJ3300D677	330 OHM 1/10 W 5% 1608 R/TP
		RA301	0RHZTCZ001D	RCA SMART 220OHM 1/16 W 5% 32
		RA305	0RHZTCZ001D	RCA SMART 220OHM 1/16 W 5% 32
		RA307	0RHZTCZ001D	RCA SMART 220OHM 1/16 W 5% 32
		RA325	0RHZTCZ001D	RCA SMART 220OHM 1/16 W 5% 32
		RA401	0RHZTCZ001D	RCA SMART 220OHM 1/16 W 5% 32
		RA402	0RHZTCZ001D	RCA SMART 220OHM 1/16 W 5% 32
		RA403	0RHZTCZ001D	RCA SMART 220OHM 1/16 W 5% 32
		RA404	0RHZTCZ001D	RCA SMART 220OHM 1/16 W 5% 32
		RA405	0RHZTCZ001D	RCA SMART 220OHM 1/16 W 5% 32
		RA406	0RHZTCZ001D	RCA SMART 220OHM 1/16 W 5% 32
		RA407	0RHZTCZ001D	RCA SMART 220OHM 1/16 W 5% 32
		RA408	0RHZTCZ001D	RCA SMART 220OHM 1/16 W 5% 32
		RA409	0RHZTCZ001D	RCA SMART 220OHM 1/16 W 5% 32
		RA410	0RHZTCZ001D	RCA SMART 220OHM 1/16 W 5% 32
		RA411	0RHZTCZ001D	RCA SMART 220OHM 1/16 W 5% 32
		RA801	0RHZTCZ001A	RCA SMART 100OHM 1/16 W 5% 3
		RA802	0RHZTCZ001A	RCA SMART 100OHM 1/16 W 5% 3
		RA803	0RHZTCZ001A	RCA SMART 100OHM 1/16 W 5% 3
		RA804	0RHZTCZ001A	RCA SMART 100OHM 1/16 W 5% 3
		RA805	0RHZTCZ001A	RCA SMART 100OHM 1/16 W 5% 3
		RA806	0RHZTCZ001A	RCA SMART 100OHM 1/16 W 5% 3
		RA807	0RHZTCZ001A	RCA SMART 100OHM 1/16 W 5% 3
		RA808	0RHZTCZ001A	RCA SMART 100OHM 1/16 W 5% 3
		RA809	0RHZTCZ001A	RCA SMART 100OHM 1/16 W 5% 3
		RA810	0RHZTCZ001A	RCA SMART 100OHM 1/16 W 5% 3
		RA811	0RHZTCZ001A	RCA SMART 100OHM 1/16 W 5% 3
		RA812	0RHZTCZ001A	RCA SMART 100OHM 1/16 W 5% 3
		RA813	0RHZTCZ001A	RCA SMART 100OHM 1/16 W 5% 3
		RA901	0RHZTCZ001D	RCA SMART 220OHM 1/16 W 5% 32
		RA902	0RHZTCZ001D	RCA SMART 220OHM 1/16 W 5% 32
		RA903	0RHZTCZ001D	RCA SMART 220OHM 1/16 W 5% 32
		RA904	0RHZTCZ001D	RCA SMART 220OHM 1/16 W 5% 32
		RA905	0RHZTCZ001D	RCA SMART 220OHM 1/16 W 5% 32
		RA906	0RHZTCZ001D	RCA SMART 220OHM 1/16 W 5% 32
		RA907	0RHZTCZ001D	RCA SMART 220OHM 1/16 W 5% 32
		RA908	0RHZTCZ001D	RCA SMART 220OHM 1/16 W 5% 32
		RA909	0RHZTCZ001D	RCA SMART 220OHM 1/16 W 5% 32
		RA910	0RHZTCZ001D	RCA SMART 220OHM 1/16 W 5% 32
		RA911	0RHZTCZ001D	RCA SMART 220OHM 1/16 W 5% 32

DATE: 2005. 05. 20.				
*S	*AL	LOC. NO.	PART NO.	DESCRIPTION / SPECIFICATION
		RA912	0RHZTCZ001D	RCA SMART 220OHM 1/16 W 5% 32
		RA913	0RHZTCZ001D	RCA SMART 220OHM 1/16 W 5% 32
		RA914	0RHZTCZ001D	RCA SMART 220OHM 1/16 W 5% 32
		RA915	0RHZTCZ001D	RCA SMART 220OHM 1/16 W 5% 32
		RA929	0RHZTCZ001A	RCA SMART 100OHM 1/16 W 5% 3
		RA930	0RHZTCZ001D	RCA SMART 220OHM 1/16 W 5% 32
		RA931	0RHZTCZ001D	RCA SMART 220OHM 1/16 W 5% 32
		RA932	0RHZTCZ001D	RCA SMART 220OHM 1/16 W 5% 32
		RA933	0RHZTCZ001D	RCA SMART 220OHM 1/16 W 5% 32
		RA934	0RHZTCZ001D	RCA SMART 220OHM 1/16 W 5% 32
		RA935	0RHZTCZ001D	RCA SMART 220OHM 1/16 W 5% 32
		RA936	0RHZTCZ001D	RCA SMART 220OHM 1/16 W 5% 32
		RA937	0RHZTCZ001D	RCA SMART 220OHM 1/16 W 5% 32
OTHERS				
		L703	0LC2000005D	"F1-B2012-332KJT,3.3 UH CERAT"
		X401	6202TST001A	"SX-1 SUNNY ,SMS, 14.31818MHZ"
		X516	6202TST003B	HC-49/SM5H KONY CHIP 18.432M
		X801	6212AB2806A	SX-1 SUNNY 24.576MHZ +/- 50
		X901	6202TST001H	SX-1 SUNNY 27MHZ +/- 30 PPM
CONTROL BOARD				
		LED1	0DLLT0089AA	LITEON LTL-1BEDJ-0C2 TP GREE
		SW1	140-058B	EVQ PB2 05K MATUSHITA NON 12
		SW2	140-058B	EVQ PB2 05K MATUSHITA NON 12
		SW3	140-058B	EVQ PB2 05K MATUSHITA NON 12
		SW4	140-058B	EVQ PB2 05K MATUSHITA NON 12
		SW5	140-058B	EVQ PB2 05K MATUSHITA NON 12
		SW6	140-058B	EVQ PB2 05K MATUSHITA NON 12
		SW7	140-058B	EVQ PB2 05K MATUSHITA NON 12
		SW8	140-058B	EVQ PB2 05K MATUSHITA NON 12
		U1	6726TV0001A	TSOP4838SO1 VISHAY 38.0KHZ L
		C2	0CK105CF94A	"1UF 1608 16V 80%,-20% R/TP F"
		C3	0CK105CF94A	"1UF 1608 16V 80%,-20% R/TP F"
		C4	0CK104CK56A	0.1UF 1608 50V 10% R/TP X7R
		C5	0CK104CK56A	0.1UF 1608 50V 10% R/TP X7R
		ZD1	0DZ560009DA	UDZ S 5.6B TP ROHM-K SOD323
		ZD2	0DZ560009DA	UDZ S 5.6B TP ROHM-K SOD323
		ZD4	0DZ560009DA	UDZ S 5.6B TP ROHM-K SOD323
		ZD5	0DZ560009DA	UDZ S 5.6B TP ROHM-K SOD323
		R1	0RJ0562D677	56 OHM 1/10 W 5% 1608 R/TP
		R10	0RJ2001D677	2K OHM 1/10 W 5% 1608 R/TP
		R2	0RJ0562D677	56 OHM 1/10 W 5% 1608 R/TP
		R3	0RJ4701D677	4.7K OHM 1/10 W 5% 1608 R/TP
		R4	0RJ4701D677	4.7K OHM 1/10 W 5% 1608 R/TP
		R5	0RJ8200D677	820 OHM 1/10 W 5% 1608 R/TP
		R6	0RJ8200D677	820 OHM 1/10 W 5% 1608 R/TP
		R7	0RJ1501D677	1.5K OHM 1/10 W 5% 1608 R/TP
		R8	0RJ1501D677	1.5K OHM 1/10 W 5% 1608 R/TP
		R9	0RJ2001D677	2K OHM 1/10 W 5% 1608 R/TP
		L1	6210TCE001H	HB-1T2012-301JT CERATEC 2012
LED & POWER BOARD				
		Q851	0TR390409AE	FAIRCHILD KST3904(LGEMTF) TP
		Q852	0TR390609FA	KST3906-MTF TP SAMSUNG SOT2
		Q853	0TR390609FA	KST3906-MTF TP SAMSUNG SOT2
		R851	0RH1002D622	10K OHM 1 / 10 W 2012 5.00%
		R852	0RH4701D622	4.7K OHM 1 / 10 W 2012 5.00%
		R853	0RH4701D622	4.7K OHM 1 / 10 W 2012 5.00%

DATE: 2005. 05. 20.

*S	*AL	LOC. NO.	PART NO.	DESCRIPTION / SPECIFICATION
		R854	0RH5100D622	510 OHM 1 / 10 W 2012 5.00%
		R855	0RH5100D622	510 OHM 1 / 10 W 2012 5.00%
		R856	0RH5100D622	510 OHM 1 / 10 W 2012 5.00%
		R857	0RH5100D622	510 OHM 1 / 10 W 2012 5.00%
		R858	0RH5100D622	510 OHM 1 / 10 W 2012 5.00%
		R859	0RH5100D622	510 OHM 1 / 10 W 2012 5.00%
		R860	0RH5100D622	510 OHM 1 / 10 W 2012 5.00%
		R861	0RH5100D622	510 OHM 1 / 10 W 2012 5.00%
		R862	0RH5100D622	510 OHM 1 / 10 W 2012 5.00%
		R863	0RH5100D622	510 OHM 1 / 10 W 2012 5.00%
		R864	0RH5100D622	510 OHM 1 / 10 W 2012 5.00%
		R865	0RH5100D622	510 OHM 1 / 10 W 2012 5.00%
		R866	0RH5100D622	510 OHM 1 / 10 W 2012 5.00%
		R867	0RH5100D622	510 OHM 1 / 10 W 2012 5.00%
		R868	0RH5100D622	510 OHM 1 / 10 W 2012 5.00%
		R869	0RH5100D622	510 OHM 1 / 10 W 2012 5.00%
		ZD851	0DZ560009DA	UDZ S 5.6B TP ROHM-K SOD323
		LED851	0DLNC0058AA	NICHIA NSCW215T R/TP WHITE 6
		LED852	0DLNC0058AA	NICHIA NSCW215T R/TP WHITE 6
		LED853	0DLNC0058AA	NICHIA NSCW215T R/TP WHITE 6
		LED854	0DLNC0058AA	NICHIA NSCW215T R/TP WHITE 6
		LED855	0DLNC0058AA	NICHIA NSCW215T R/TP WHITE 6
		LED856	0DLNC0058AA	NICHIA NSCW215T R/TP WHITE 6
		LED857	0DLNC0058AA	NICHIA NSCW215T R/TP WHITE 6
		LED858	0DLNC0058AA	NICHIA NSCW215T R/TP WHITE 6

SCHEMATIC DIAGRAM

1. AUDIO CTL / AMP

1 M32/37/42C
AUDIO CTL / AMP

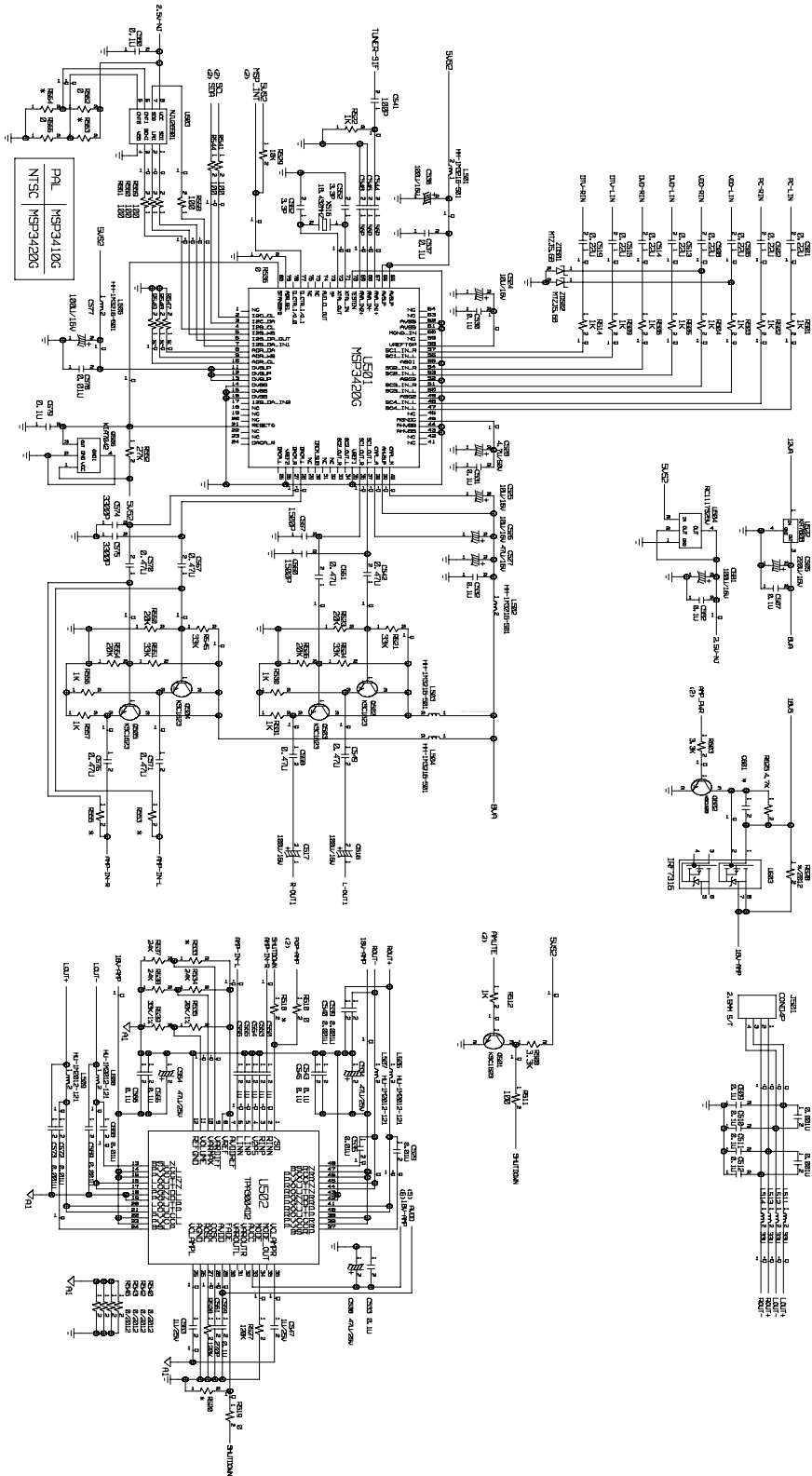

3. MST9883

#3 M32/37/42C
MST9883

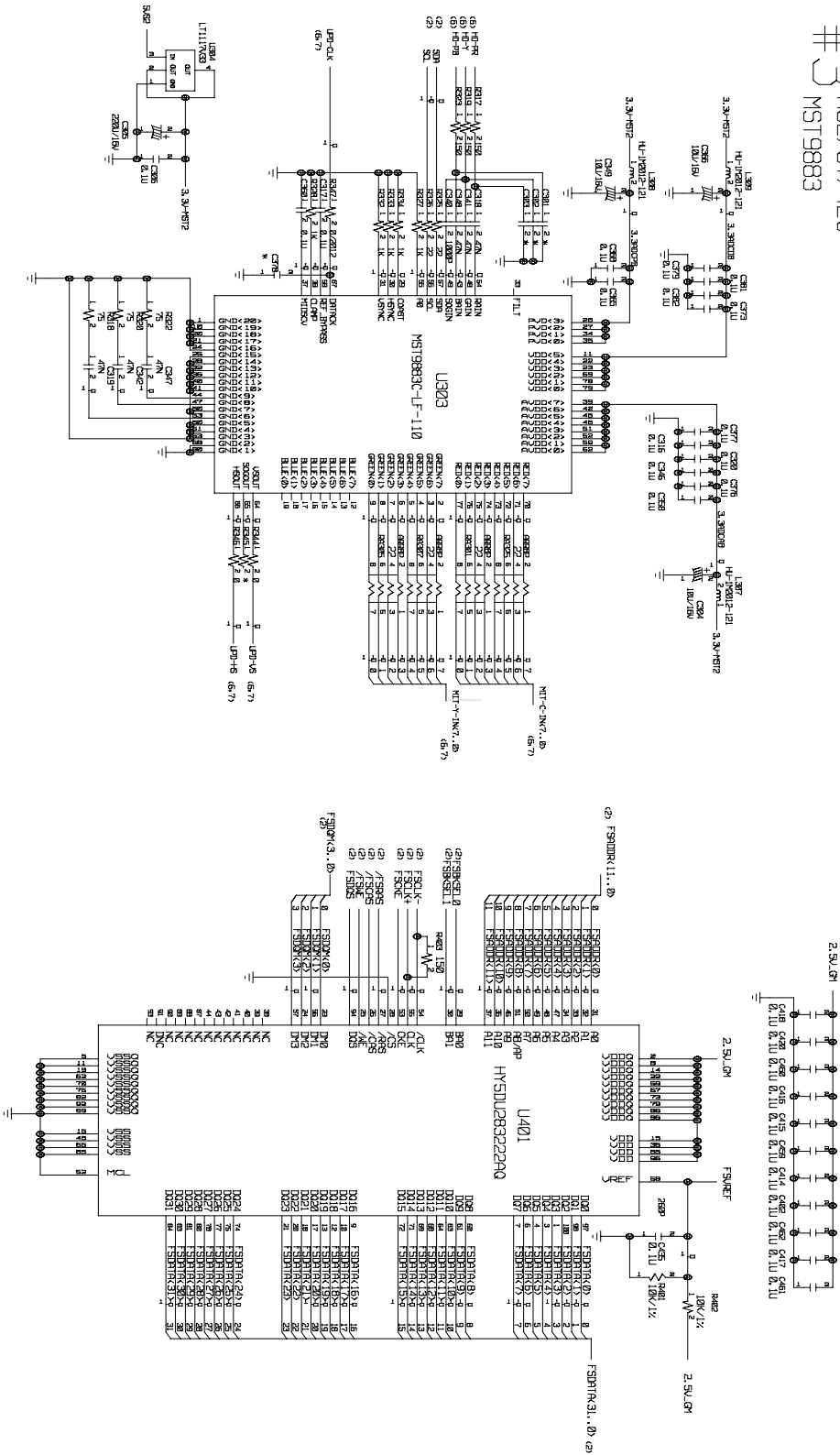

4. POWER / CONNECTOR

4 M32/37/42C
POWER/CONNECTOR

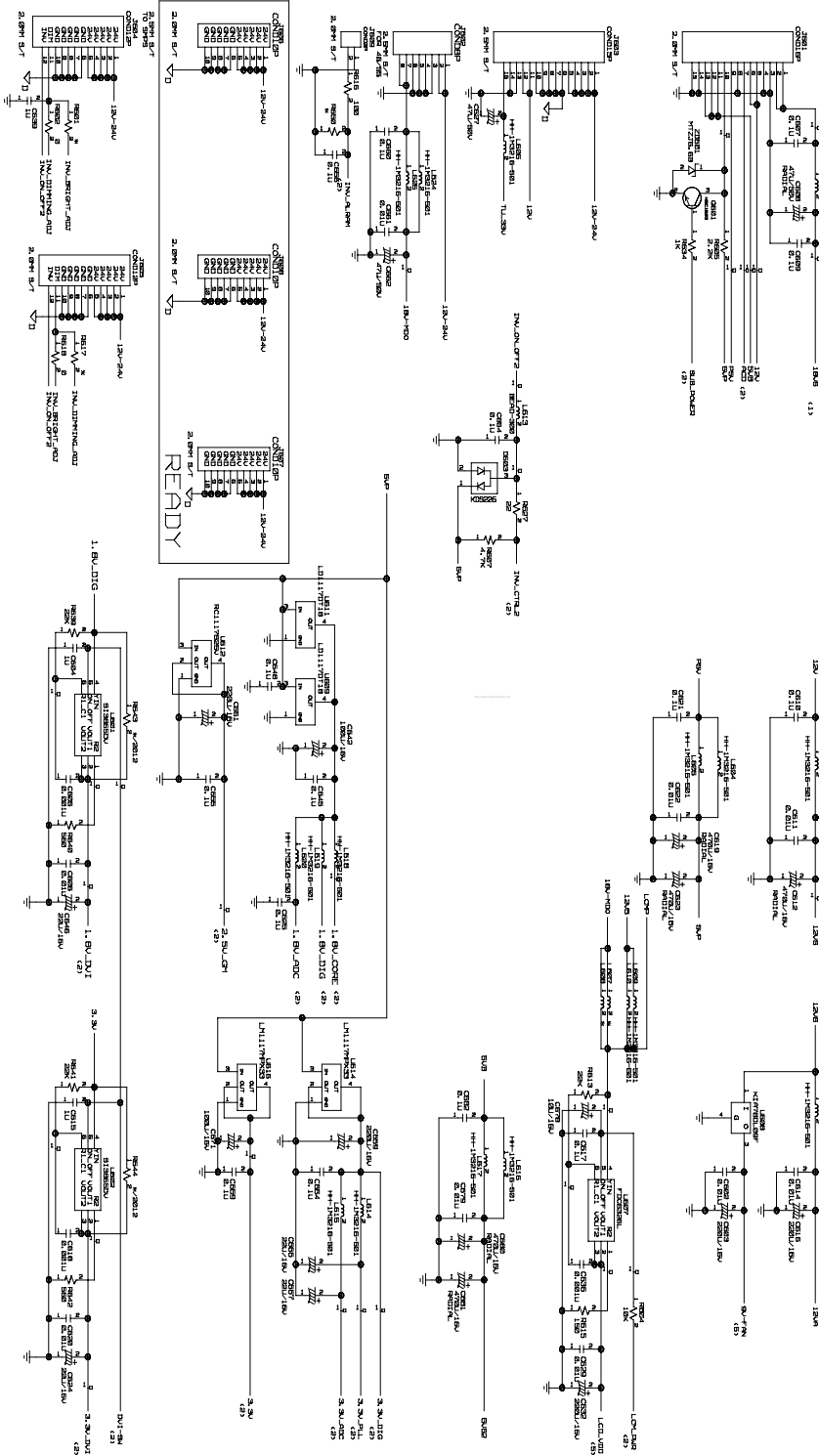

6. UPD64012 / K4S161622

#6 M32/37/42C
UPD64012/K4S161622

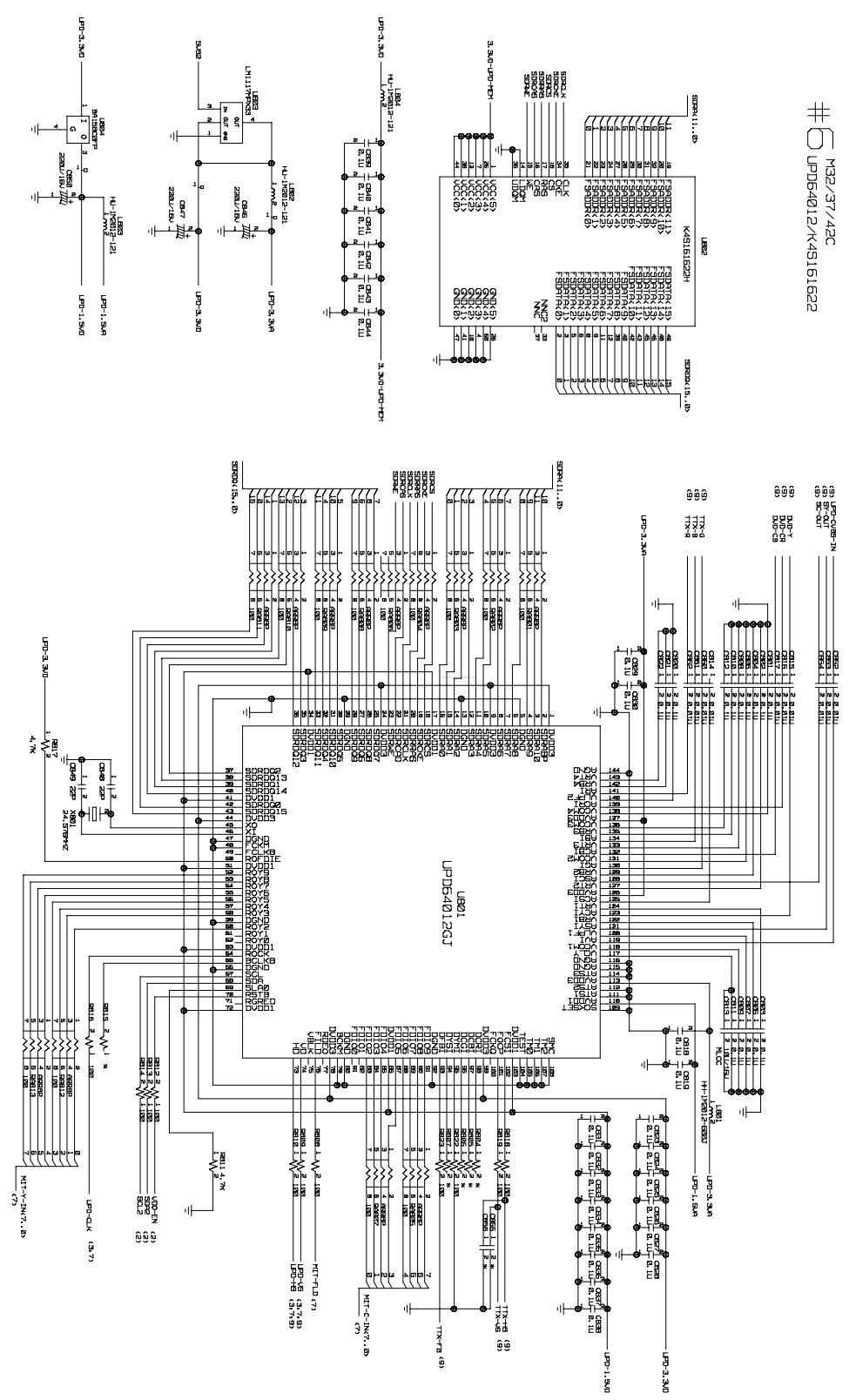

7. MDIN150 / MEMORY

7 M32/37/42C
MDIN150/MEMORY

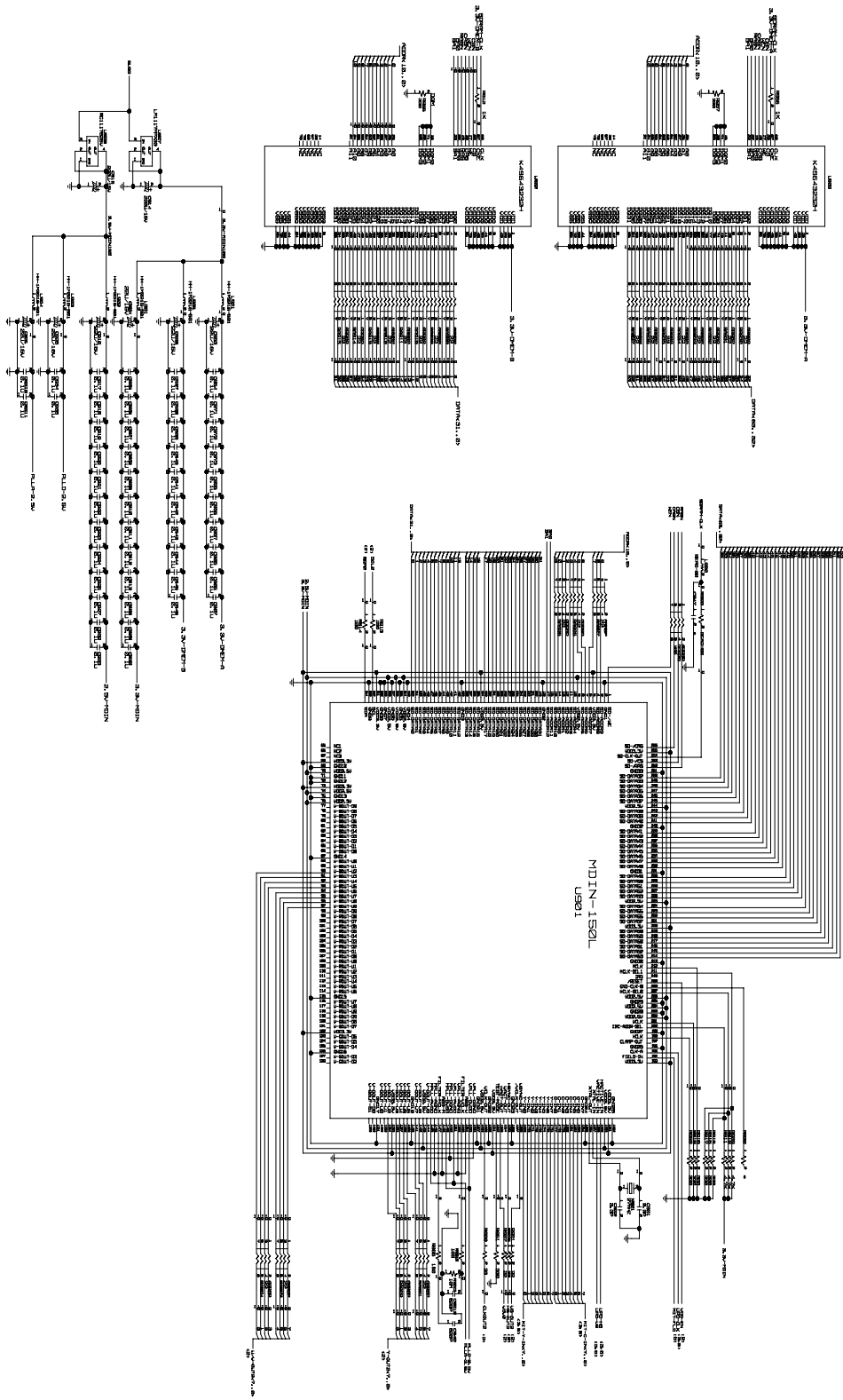

8. DSUB / DVI-D / BA7657

M32/37/42C
DSUB/DVI-D/BA7657

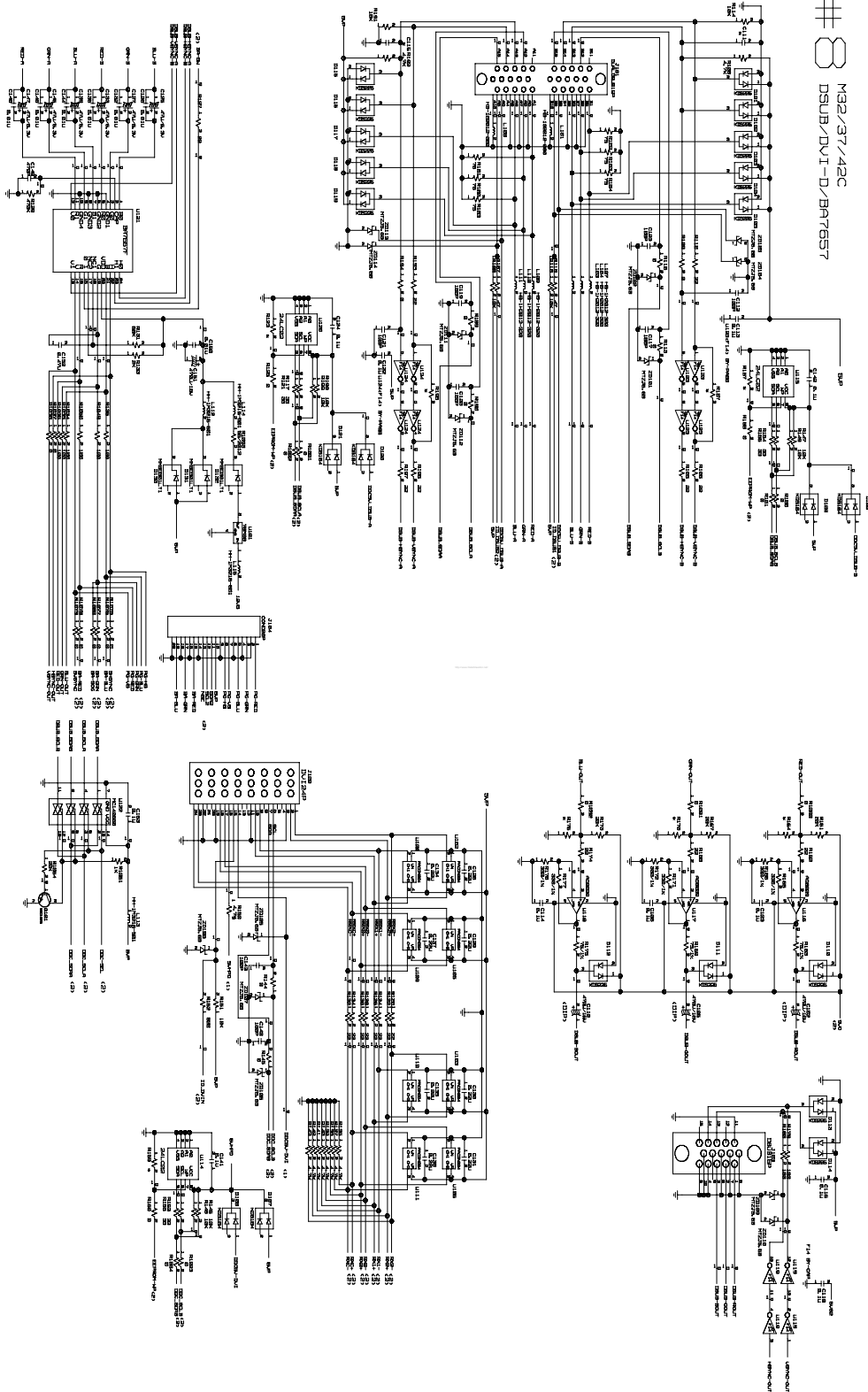

9. CXA2040AQ / TUNER / M37272M6 / AV-JACK

#9 M32/37/42C
CXA2040AQ/TUNER/M37272M6/AV-JACK

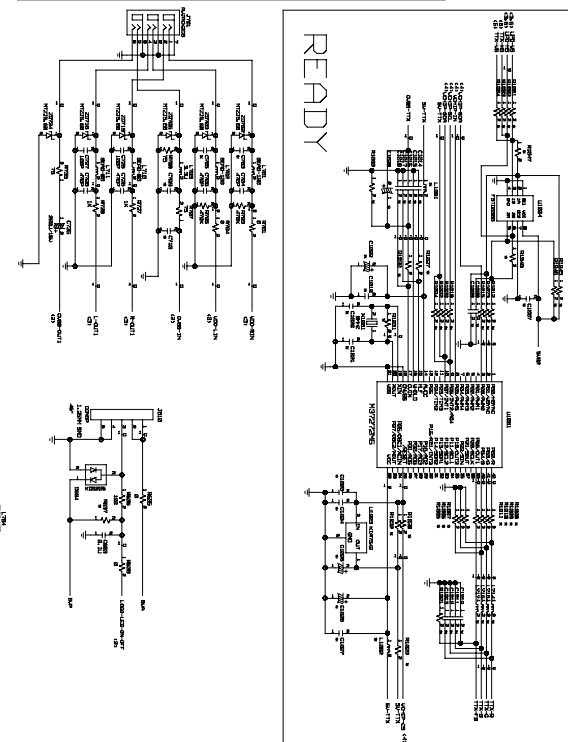
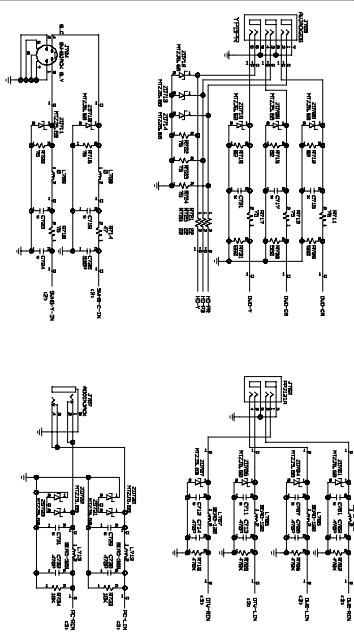
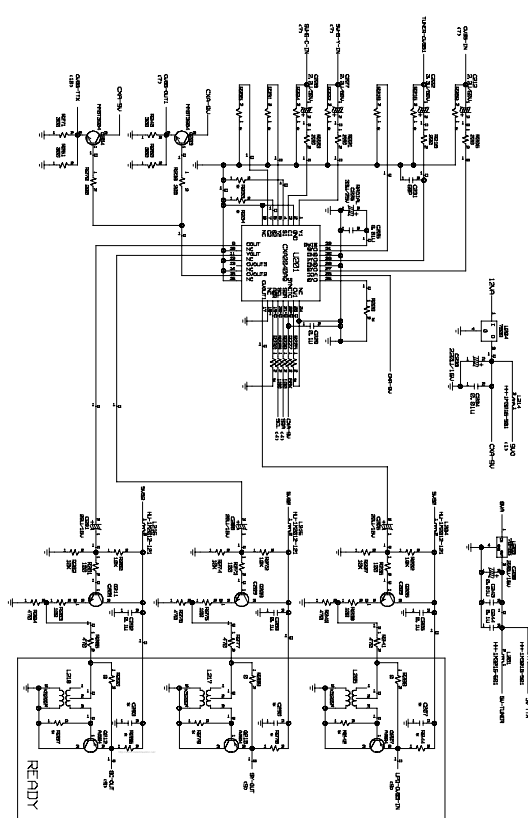
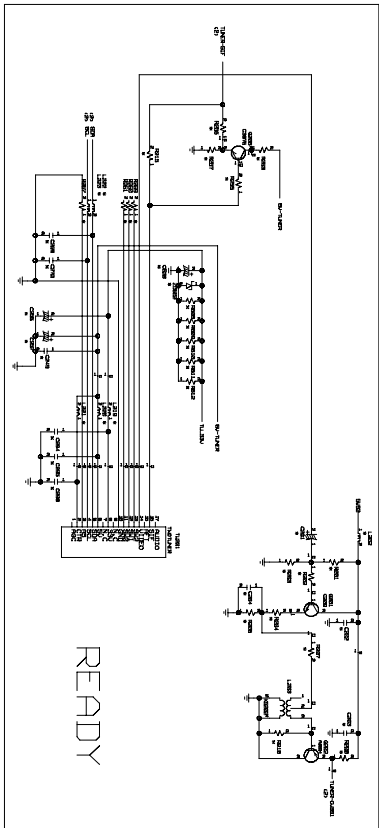

10. KEY CONTROL

1 KEY CONTROL

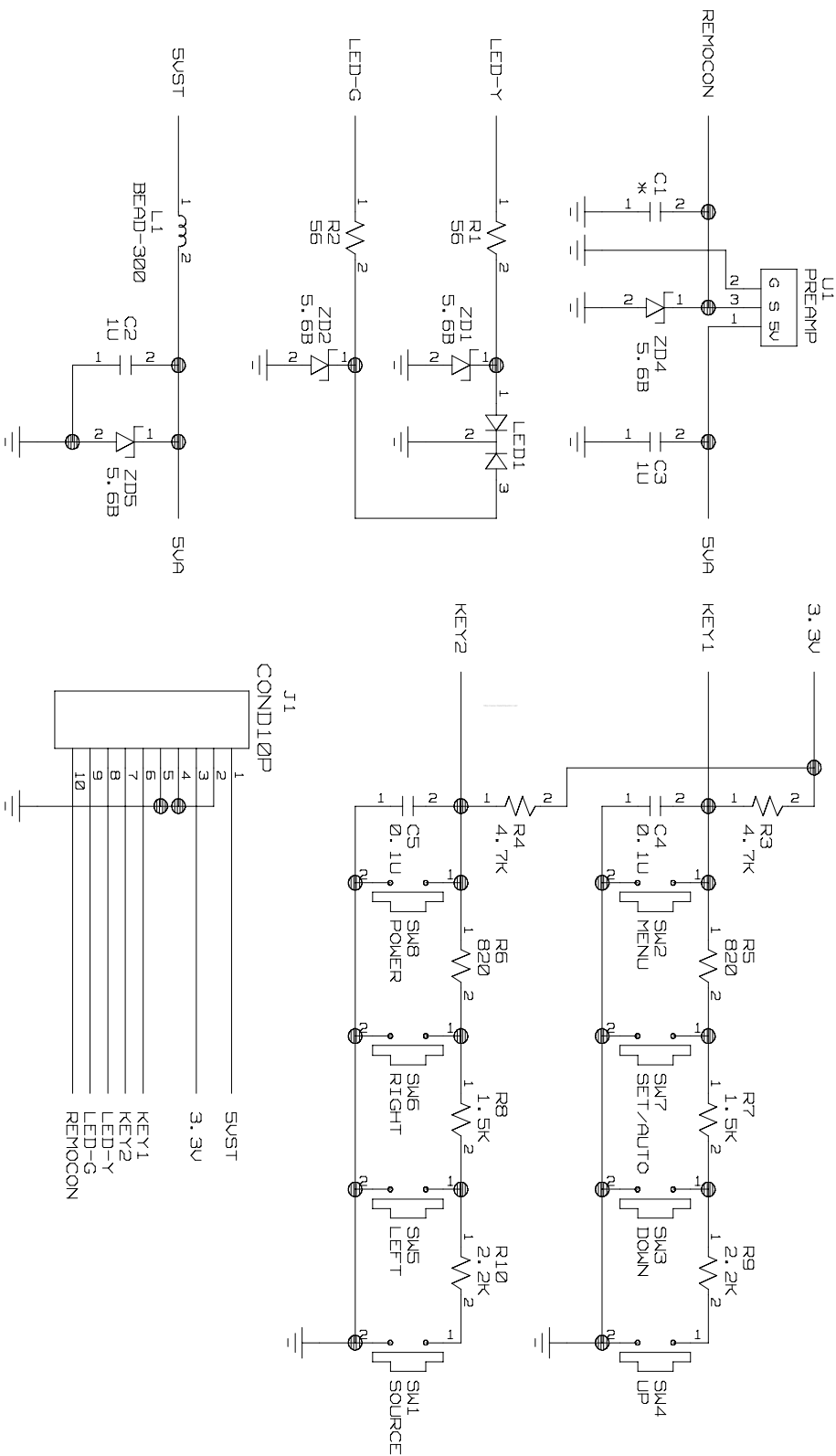



P/NO : 38289S0001V

Jun. 2005
Printed in Korea