

Description

The S62FP series is a group of positive voltage output, three-pin regulators, that provide a high current even when the input/output voltage differential is small. Low power consumption and high accuracy is achieved through CMOS and laser trimming technologies. The S62FP consists of a high-precision voltage reference, an error amplification circuit, and a current limited output driver. Transient response to load variations have improved in comparison to the existing series.

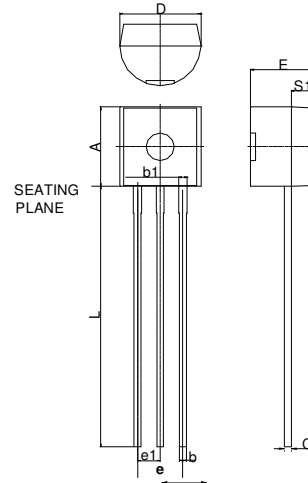

Features

- * Small Input-Output Differential: $I_{OUT}=100mA @ V_{OUT}=5V$ with a 0.12V differential
- * Highly Accurate: Output Voltage $\pm 2\%$
- * Low Power Consumption: Typ. $2\mu A @ V_{OUT}=5V$
- * Output Voltage Range: 1.5V~6V in 0.1V increments
- * Input Stability: Typ. 0.2%/V
- * Output Voltage Temperature Characteristics: Typ. $\pm 100ppm/^{\circ}C$
- * Max. Output Current: 250mA (Within Max. Power Dissipation, $V_{OUT}=5V$)

REF.	Millimeter		REF.	Millimeter	
	Min.	Max.		Min.	Max.
A	4.45	4.7	D	4.44	4.7
S1	1.02	-	E	3.30	3.81
b	0.36	0.51	L	12.70	-
b1	0.36	0.76	e1	1.150	1.390
C	0.36	0.51	e	2.42	2.66

Applications

- * Reference Voltage Source
- * Palmtops
- * Battery Powered Equipment
- * Portable Cameras And Video Recorders

Marking :

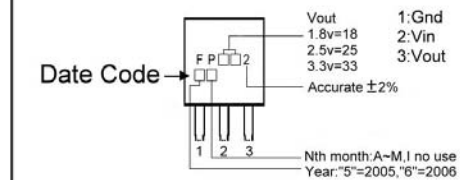

Typical Application Circuit

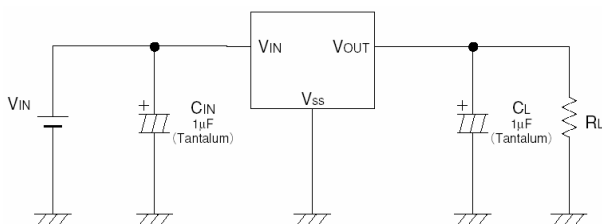

Block Diagram

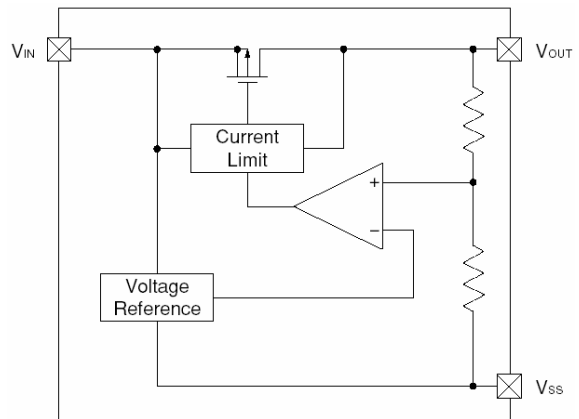

Absolute Maximum Ratings $T_a=25^\circ\text{C}$

Parameter	Symbol	Ratings	Unit
Input Voltage	V_{IN}	12	V
Output Current	I_{OUT}	500	mA
Output Voltage	V_{OUT}	$V_{SS}-0.3-V_{IN}+0.3$	V
Operating Ambient Temperature	T_{opr}	-40~+85	$^\circ\text{C}$
Storage Temperature	T_{stg}	-40~+125	$^\circ\text{C}$
Continuous Total Power Dissipation	P_D	500	mW

Electrical Characteristics $T_a=25^\circ\text{C}$

S62FP-50 $V_{OUT}(T) = 5.0V$ (Note1)

Parameter	Symbol	Condition	Min	TYP	Max	Unit
Output Voltage	$V_{OUT(E)}$ (Note2)	$V_{IN}=6.0V, I_{OUT}=40mA$	4.900	5.000	5.100	V
Max. Output Current	$I_{OUT\ max}$	$V_{IN}=6V, V_{OUT(E)} \geq 4.5V$	250	-	-	mA
Load Stability	ΔV_{OUT}	$V_{IN}=6V, I_{OUT}=1mA$ to 100mA	-	40	80	mV
Input-Output Voltage Differential (Note3)	V_{dif1}	$I_{OUT}=100mA$	-	120	300	mV
	V_{dif2}	$I_{OUT}=200mA$	-	380	600	
Supply Current	I_{SS}	$V_{IN}=6V$	-	2.0	5.0	μA
Input Stability	$\frac{\Delta V_{OUT}}{\Delta V_{IN} \cdot V_{OUT}}$	$I_{OUT}=40mA$ $V_{IN}=6V$ to 10V	-	0.2	0.3	%/V
Input Voltage	V_{IN}		-	-	10	V
Output Voltage Temperature Characteristics	$\frac{\Delta V_{OUT}}{\Delta T_{opr} \cdot V_{OUT}}$	$I_{OUT}=40mA$ $-40^\circ\text{C} \leq T_{opr} \leq 85^\circ\text{C}$	-	± 100	-	ppm/ $^\circ\text{C}$

Note 1: $V_{OUT}(T)$ =Specified Output Voltage.

2: $V_{OUT}(E)$ =Effective Output Voltage (i.e. the output voltage when " $V_{OUT}(T) + 1.0V$ " is provided at the V_{IN} pin while maintaining a certain I_{OUT} value).

3: $V_{dif} = V_{IN}^{(Note4)} - V_{OUT}(E)$

4: V_{IN1} =The input voltage at the time 98% of $V_{OUT}(E)$ is output (input voltage has been gradually reduced).

S62FP-40 $V_{OUT}(T) = 4.0V$ (Note1)

Parameter	Symbol	Condition	Min	TYP	Max	Unit
Output Voltage	$V_{OUT(E)}$ (Note2)	$V_{IN}=5.0V, I_{OUT}=40mA$	3.920	4.000	4.080	V
Max. Output Current	$I_{OUT\ max}$	$V_{IN}=5V, V_{OUT(E)} \geq 3.6V$	200	-	-	mA
Load Stability	ΔV_{OUT}	$V_{IN}=5V, I_{OUT}=1mA$ to 100mA	-	45	90	mV
Input-Output Voltage Differential (Note3)	V_{dif1}	$I_{OUT}=100mA$	-	170	330	mV
	V_{dif2}	$I_{OUT}=200mA$	-	400	630	
Supply Current	I_{SS}	$V_{IN}=5V$	-	2.0	4.5	μA
Input Stability	$\frac{\Delta V_{OUT}}{\Delta V_{IN} \cdot V_{OUT}}$	$I_{OUT}=40mA$ $V_{IN}=5V$ to 10V	-	0.2	0.3	%/V
Input Voltage	V_{IN}		-	-	10	V
Output Voltage Temperature Characteristics	$\frac{\Delta V_{OUT}}{\Delta T_{opr} \cdot V_{OUT}}$	$I_{OUT}=40mA$ $-40^\circ\text{C} \leq T_{opr} \leq 85^\circ\text{C}$	-	± 100	-	ppm/ $^\circ\text{C}$

S62FP-30 V_{OUT} (T) = 3.0V (Note1)

Parameter	Symbol	Condition	Min	TYP	Max	Unit
Output Voltage	V _{OUT} (E) (Note2)	V _{IN} =4.0V, I _{OUT} =40mA	2.940	3.000	3.060	V
Max. Output Current	I _{OUT max}	V _{IN} =4V, V _{OUT} (E)≥2.7V	150	-	-	mA
Load Stability	ΔV _{OUT}	V _{IN} =4V, I _{OUT} =1mA to 80mA	-	45	90	mV
Input-Output Voltage Differential (Note3)	V _{dif1}	I _{OUT} =80mA	-	180	360	mV
	V _{dif2}	I _{OUT} =160mA	-	400	700	
Supply Current	I _{SS}	V _{IN} =4V	-	2.0	4.5	μA
Input Stability	$\frac{\Delta V_{OUT}}{\Delta V_{IN} \cdot V_{OUT}}$	I _{OUT} =40mA V _{IN} =4V to 10V	-	0.2	0.3	%/V
Input Voltage	V _{IN}		-	-	10	V
Output Voltage Temperature Characteristics	$\frac{\Delta V_{OUT}}{\Delta T_{opr} \cdot V_{OUT}}$	I _{OUT} =40mA -40°C ≤ T _{opr} ≤ 85°C	-	±100	-	ppm/°C

S62FP-20 V_{OUT} (T) = 2.0V (Note1)

Parameter	Symbol	Condition	Min	TYP	Max	Unit
Output Voltage	V _{OUT} (E) (Note2)	V _{IN} =3.0V, I _{OUT} =40mA	1.960	2.000	2.040	V
Max. Output Current	I _{OUT max}	V _{IN} =3V, V _{OUT} (E)≥1.8V	100	-	-	mA
Load Stability	ΔV _{OUT}	V _{IN} =3V, I _{OUT} =1mA to 60mA	-	45	90	mV
Input-Output Voltage Differential (Note3)	V _{dif1}	I _{OUT} =60mA	-	180	360	mV
	V _{dif2}	I _{OUT} =120mA	-	400	700	
Supply Current	I _{SS}	V _{IN} =3V	-	2.0	4.5	μA
Input Stability	$\frac{\Delta V_{OUT}}{\Delta V_{IN} \cdot V_{OUT}}$	I _{OUT} =40mA V _{IN} =3V to 10V	-	0.2	0.3	%/V
Input Voltage	V _{IN}		-	-	10	V
Output Voltage Temperature Characteristics	$\frac{\Delta V_{OUT}}{\Delta T_{opr} \cdot V_{OUT}}$	I _{OUT} =40mA -40°C ≤ T _{opr} ≤ 85°C	-	±100	-	ppm/°C

Test Circuit

Circuit1

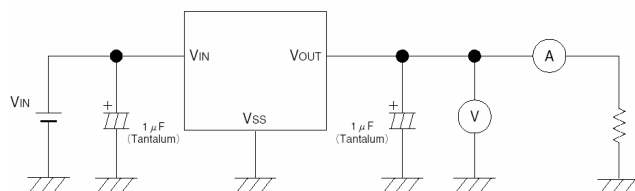

Circuit2

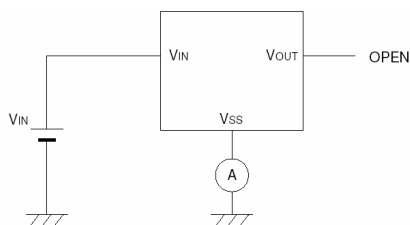

Characteristics Curve

(1) Output Voltage vs. Output Current

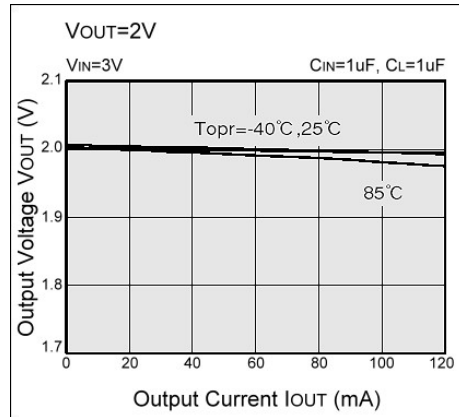
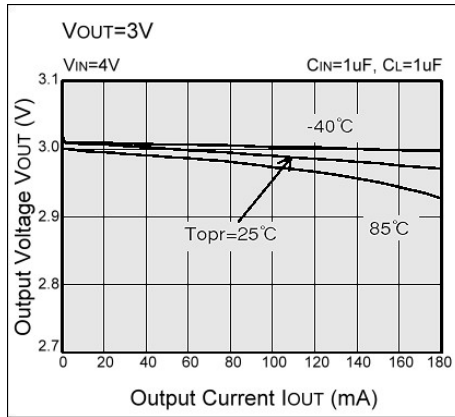
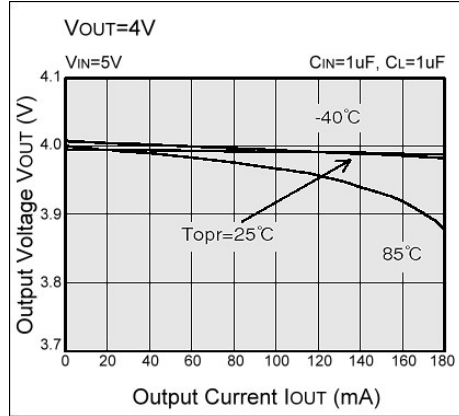
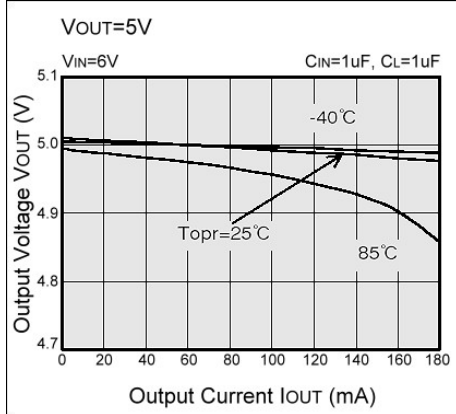

(2) Output Voltage vs. Input Voltage

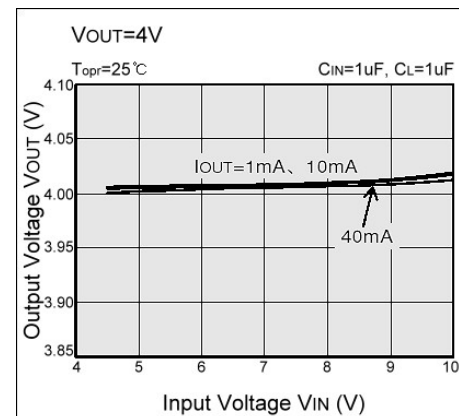
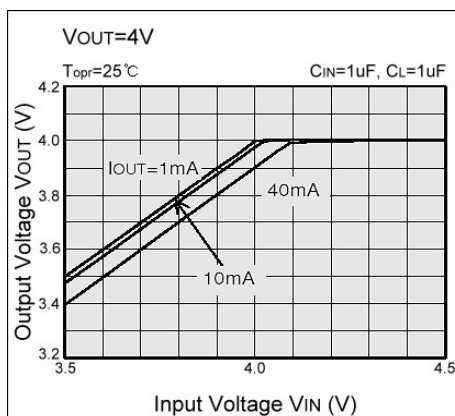
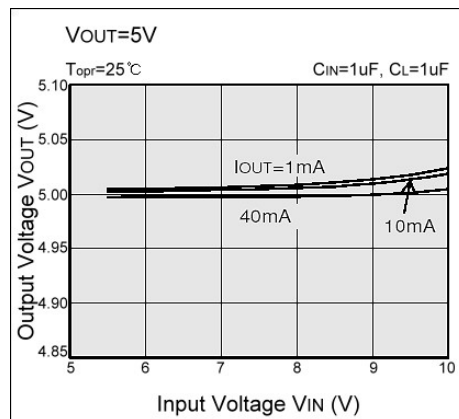
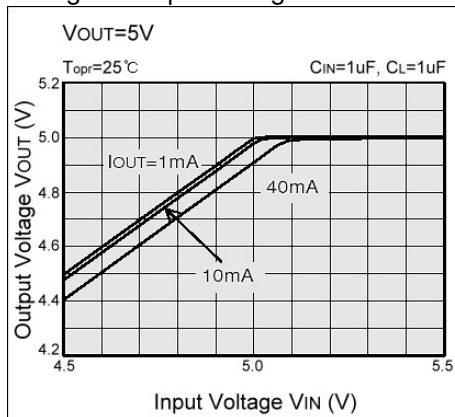

(2) Output Voltage vs. Input Voltage

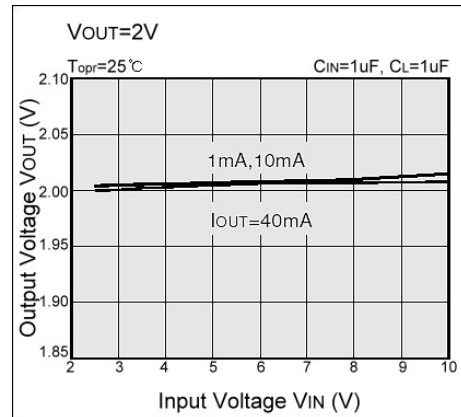
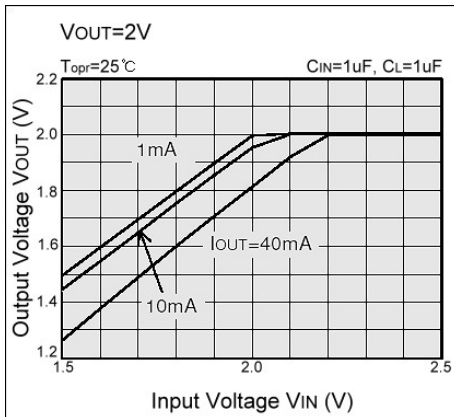
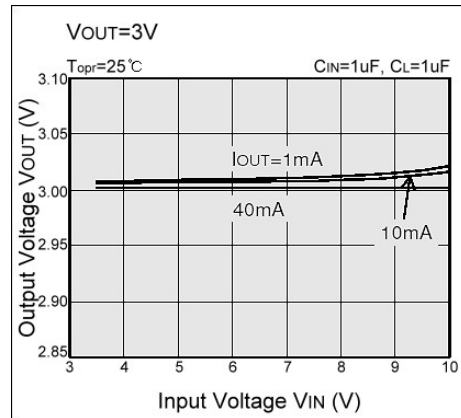
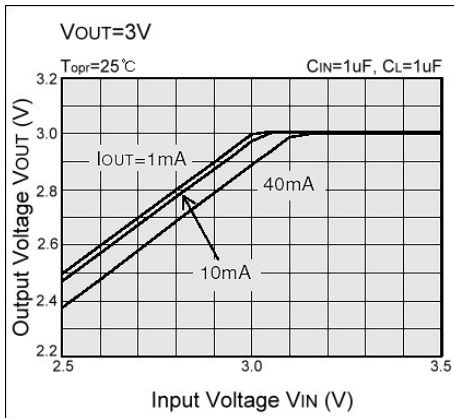

(3) Input/Output Voltage Differential vs. Output Current

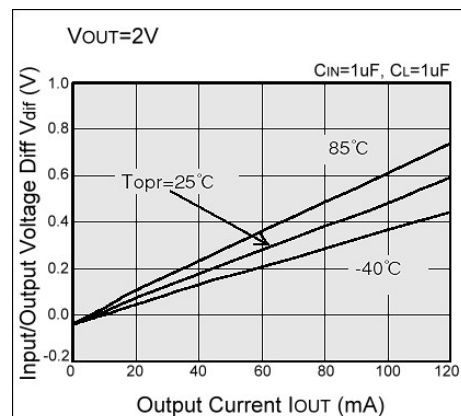
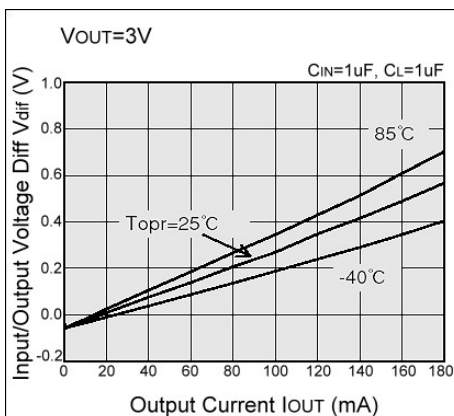
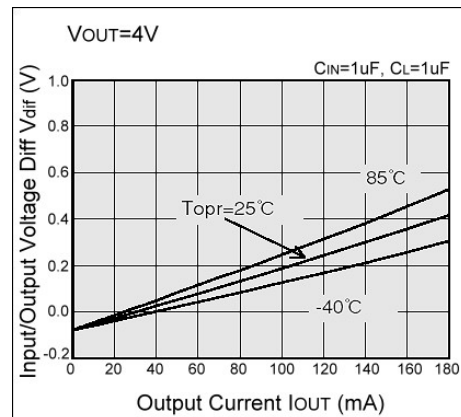
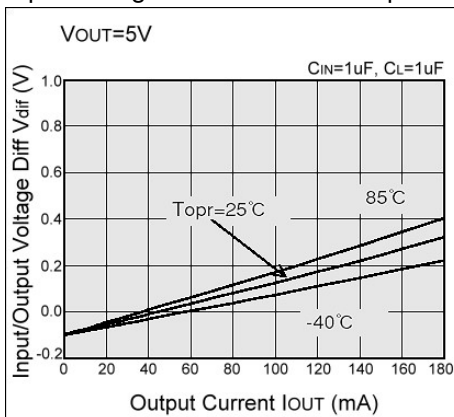

(4) Supply Current vs. Input Voltage

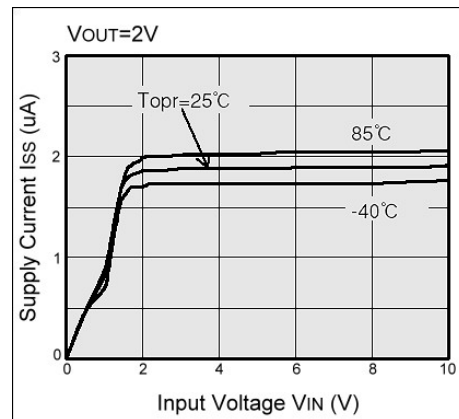
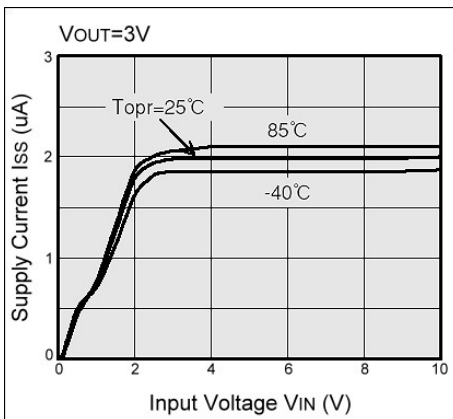
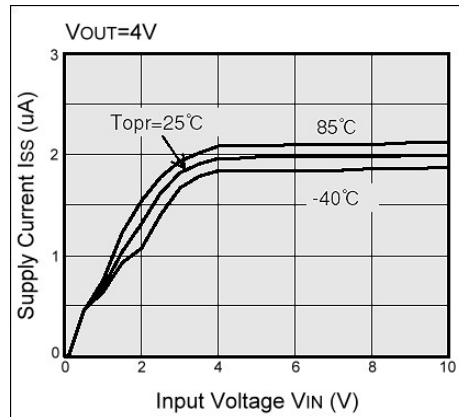
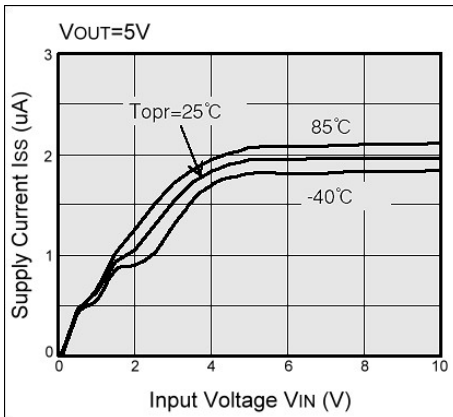

(5) Supply Current vs. Ambient Temperature

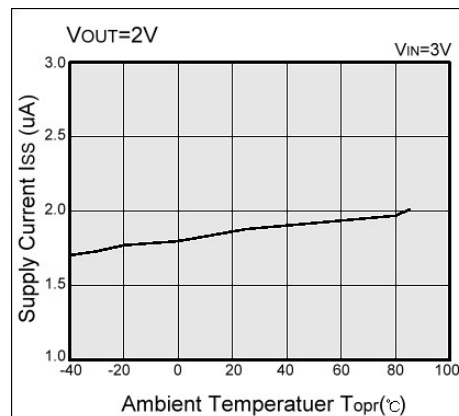
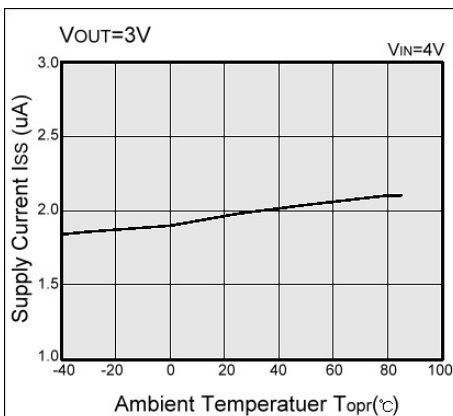
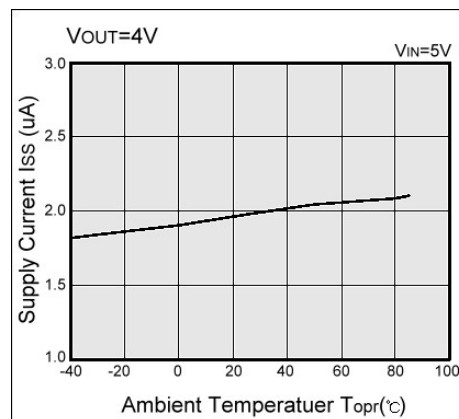
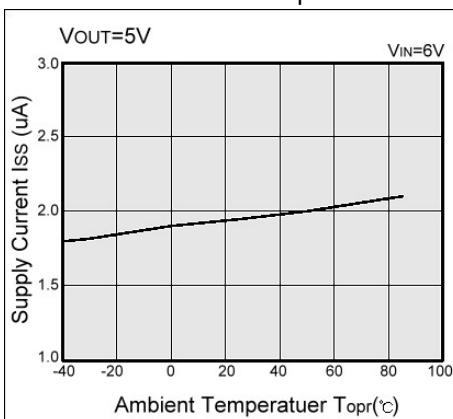

(6) Output Voltage vs. Ambient Temperature

