

All exposed cast aluminum components are made of non corrosive pure aluminum copper free (Aluminum is less than .1% copper content.#356 alloy.)

Finish: All polyester powder baked coatings preceded with a 5 baths preparation process. Meets military grade MIL-C781706 with a 2000 hours salt spray test.

- Pulse rated porcelain socket or 75W/600V thermoplastic compact fluorescent socket.
- One-piece molded silicone gasket with memory retention.
- High power factor CWA ballast. Or 98% P.F.electronic smart ballast with end of life detection for compact fluorescent.
- All stainless steel hardware.
- All Moving and removable parts are sealed with a memory retention silicone gasket.

- 1- #12 Ga, Galvanized wall pressure mounting plate.
- 2- Cast aluminum ballast housing.
- 3- Cast aluminum modular optical light chamber.
- 4- Up-light clear tempered glass.
- Flush mount installation to avoid accumulation of debris.
- 5- Semi-specular aluminum reflector.
- 6- Cast aluminum sealed lens frame
- 7- Clear tempered lens.

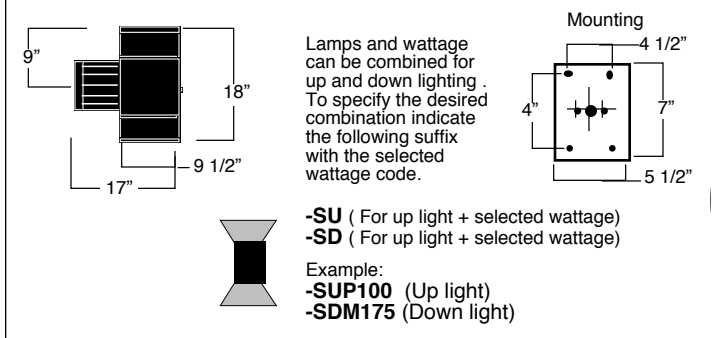
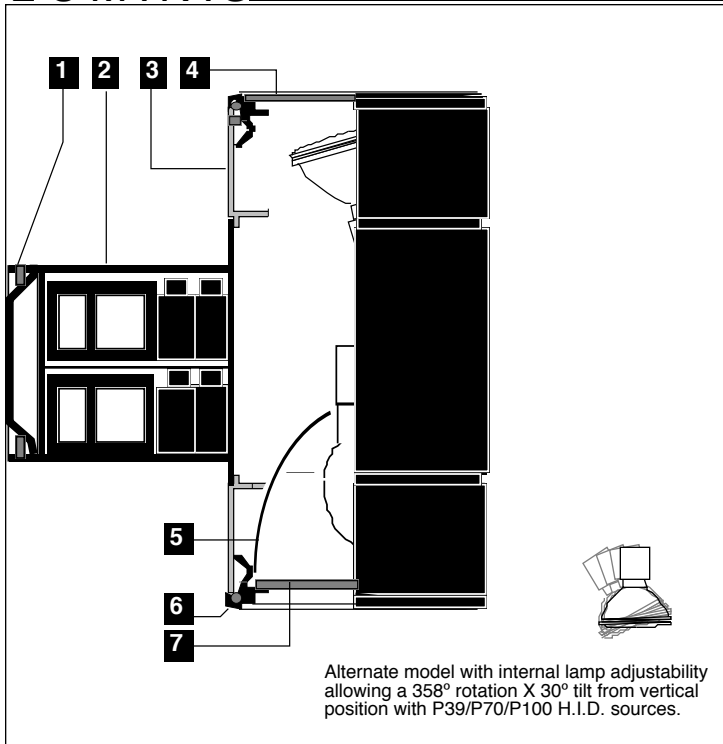

Photometry

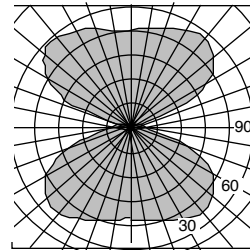

Separate updated technical specification sheets with related models and light sources with I.E.S formatted photometry are available on www.luminis.com.

Certification

UL. Wet Location.

Mounting

Max. weight: 40 lbs.
 Installation: Mounts over a standard 4" octagonal electrical box with 3 1/2" c/c mounting holes. (by others). Additional separate mounting holes are provided with wall plate..

Please refer to page 128 for additional details.

Model#	Light source selection	Voltage	Finish	Options
<input type="checkbox"/> W1280	MH (ED17) <input type="checkbox"/> 2M70 <input type="checkbox"/> 2M100 <input type="checkbox"/> 2M150 <input type="checkbox"/> 2M175	120 V Standard factory prewired (If no voltage is specified) For other voltages, please specify with catalog number.	(Refer to color chart) Standard selection <input type="checkbox"/> WHT: Snow white <input type="checkbox"/> BKT: Jet black <input type="checkbox"/> BZT: Bronze <input type="checkbox"/> GRT: Titanium gray <input type="checkbox"/> DGT: Gun metal <input type="checkbox"/> CHT: Champagne <input type="checkbox"/> MST: Matte silver <input type="checkbox"/> GNT: Forest green Optional colors <input type="checkbox"/> CS: Custom color <input type="checkbox"/> RAL: RAL# color	<input type="checkbox"/> L: Accessories Set of 3 cast aluminum lower rings. <input type="checkbox"/> SU: Alternate up light source. (Please specify) <input type="checkbox"/> SD: Alternate down light source. (Please specify)
	HPS (ED17) <input type="checkbox"/> 2H70 <input type="checkbox"/> 2H100 <input type="checkbox"/> 2H150			
	CF (Gx24q) Single lamp <input type="checkbox"/> F2142 <input type="checkbox"/> F2157	Compact fluorescent smart ballast 120/277 <input type="checkbox"/> 347 V (To specify)		<input type="checkbox"/> EM optional battery test switch and pilot lamp are installed remotely. (See page 103)
	CF (Gx24q) Two lamp <input type="checkbox"/> 4F226 <input type="checkbox"/> 4F232			
	PAR lamps <input type="checkbox"/> 2PH39 (PAR20) <input type="checkbox"/> 2PH70 (PAR30L) <input type="checkbox"/> 2PH100 (PAR38)			
	(Lamps by others) Adjustable lamps			

Luminaries may be altered for improvements or discontinued without prior notice.

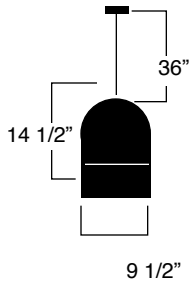

-S 15° swivel mount with 5/8" dia. X36"lg. aluminum stem. Luminaire top adaptor allowing to cut stem to length on site. (Mounts over a standard 4" octagonal box with 3 1/2" C/C holes)

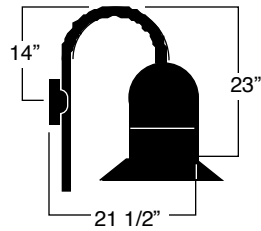

-W2 -1 1/2" Dia. shepherd aluminum arm wall mount, with a cast aluminum wall cover and galvanized steel mounting plate.

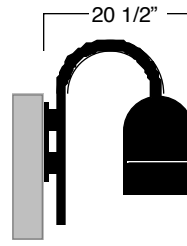

-APA2 -1 1/2" Dia. shepherd aluminum side pole mount. (EPA:1.12)

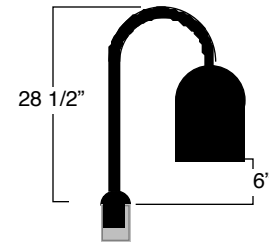

-APS -1 1/2" Dia. shepherd aluminum post top mount, with a cast aluminum tenon to fit with a 3 3/4" I.D. pole (EPA:1.17)

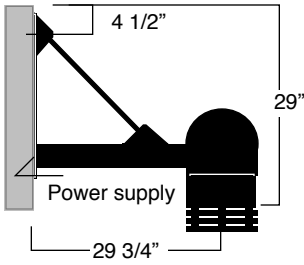

-ACA2 -1" x 3" extruded aluminum Davit arm pole mounting adaptor designed to fit with 4 to 5" dia. poles. 1/2" dia. X 45° standard natural stainless steel rod support (EPA:1.58)

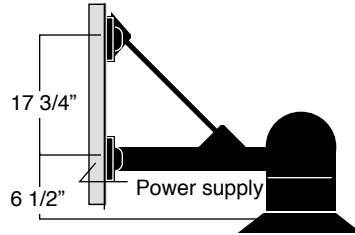

-ACW2 -1" x 3" extruded aluminum Davit arm wall mounting adaptor with cast aluminum covers and galvanized steel mounting plates. 1/2" dia. X 45° standard natural stainless steel rod support.

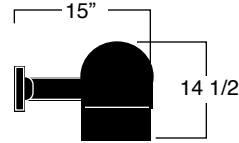

-T2 -1" x 3" extruded aluminum wall mounting straight adaptor with cast aluminum cover and galvanized steel mounting plate.

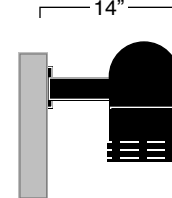

-APC2 -1" x 3" extruded aluminum side pole mounting straight adaptor (EPA:1.3)

Compatible poles listing.

Post side mount with APA2 attachment accessory

Mounting style



4" O.D.	5" O.D.	4" O.D.	4" O.D.	Pole height
PAA410-APA	PAA510-APA		PXD10-APA	10 ft
PAA412-APA	PAA512-APA	PCA12-APA	PXD12-APA	12 ft
PAA414-APA	PAA514-APA	PCA14-APA	PXD14-APA	14 ft
PAA416-APA	PAA516-APA	PCA16-APA	PXD16-APA	16 ft
PAA418-APA	PAA518-APA		PXD18-APA	18 ft
PAA420-APA	PAA520-APA		PXD20-APA	20 ft

Post side mount with APC2 attachment accessory

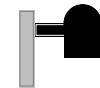

PAA410-APC	PAA510-APC		PXD10-APC	10 ft
PAA412-APC	PAA512-APC	PCA12-APC	PXD12-APC	12 ft
PAA414-APC	PAA514-APC	PCA14-APC	PXD14-APC	14 ft
PAA416-APC	PAA516-APC	PCA16-APC	PXD16-APC	16 ft
PAA418-APC	PAA518-APC		PXD18-APC	18 ft
PAA420-APC	PAA520-APC		PXD20-APC	20 ft

Post side mount with APS attachment accessory



PAA410-A	PAA510-A1	PCA10-A	PXD10-A	10 ft
PAA412-A	PAA512-A1	PCA12-A	PXD12-A	12 ft
PAA414-A	PAA514-A1	PCA14-A	PXD14-A	14 ft
PAA416-A	PAA516-A1	PCA16-A	PXD16-A	16 ft
PAA418-A	PAA518-A1		PXD18-A	18 ft
PAA420-A	PAA520-A1		PXD20-A	20 ft

Post side mount with ACA2 attachment accessory



PAA414-ACA	PAA514-ACA	PCA14-ACA	PXD14-ACA	14 ft
PAA416-ACA	PAA516-ACA	PCA16-ACA	PXD16-ACA	16 ft
PAA418-ACA	PAA518-ACA		PXD18-ACA	18 ft
PAA420-ACA	PAA520-ACA		PXD20-ACA	20 ft

For poles details and specification, please refer to pages 140 to 144

* Note:
36" extension with ACA2 attachment
24" extension with APA2 & APC2 attachment

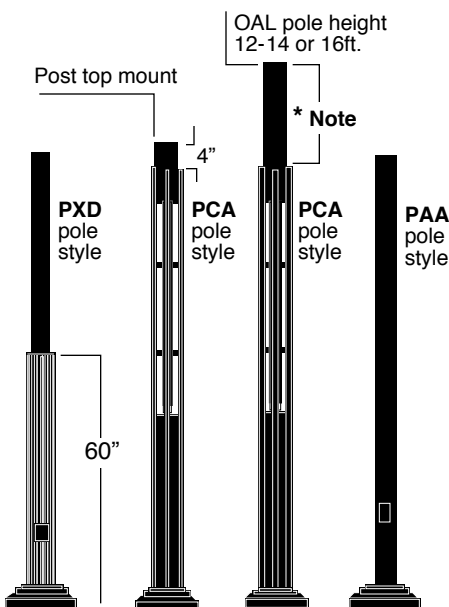

Slope ceiling adaptor

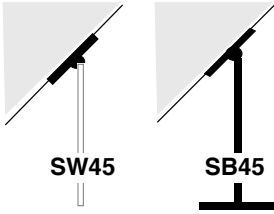

Option: **SW45**
45° hang straight ball swivel for 5/8" dia. suspension stem.

Option: **SB45**
45° hang straight ball swivel for 5/8" dia. suspension stem. with adaptor plate for W1250S

Longer suspension stem

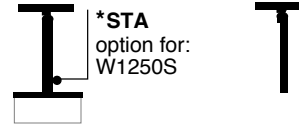

Stems can be cut on site and rethreaded externally (Tap size 1/4 IPS / 1/4-18)

Option

STM60	STA60:	60" lg. X5/8" O.D. suspension stem.
STM80	STA80:	80" lg. X5/8" O.D. suspension stem.

For other factory cut to size length add suffix **-STM** with desired length to catalog# max.120"

Suspension power cord



Note: cable size and type may change at factory discretion upon availability, to accommodate required wiring with selected option.

Option: **SPW** (White)
SPB (Black)

3/18 X 36"lg. power cord with adjustable aircraft cable.

SPB Black power cable only with options
EM42
EM242
QS

Spiral suspension power cord

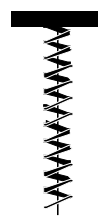

Option: **TCW** (White)
TCB (Black)

3/18 Spiral power cord Max. 277V
Standard extended length: 3ft.
Not applicable when using options
EM42
EM242
QS

Safety suspension cable



Option: **STC**

Safety aircraft suspension cable, for applications with earthquake regulations. Cables extends 18" beyond canopy. (Secured to building structure)

Overall length change:

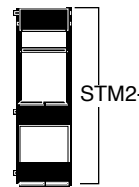

Option: **STM2**

Change total suspension length from standard length. Specify desired length in inches. EX: STM2-72"

Quartz lamp restrike

Option: **QRS**

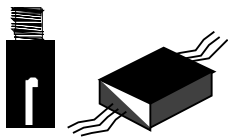

Quartz restrike standby lamp kit. When power failure is restored, it will energize temporary Quartz lamp with progressive dimming until full H.I.D light output is produced. max.100w DC bayonet type. (Lamp is not included.) Not Applicable with CFL lamps.

Quartz lamp restrike

Option: **QS**



Quartz lamp socket for external 120V emergency power input. Separate 120V dedicated wiring is included. max.100 W DC bayonet type. (Lamp is not included.) Not Applicable with CFL lamps.

Emergency battery back-up

EM42 / EM42S

One lamp:

26w: 450 Lmns.
32w: 575 Lmns.
42w: 750 Lmns.
Time: 90 Mnts -120/277V / T 0° C

Note: Use of Emergency battery, requires periodic and regular testing to ensure correct operation. (please refer to manufacturer's instructions.)

For 57w & 70w:
(Remote installation only) Consult factory

EM Ballast wiring diagram for 120V factory connection.

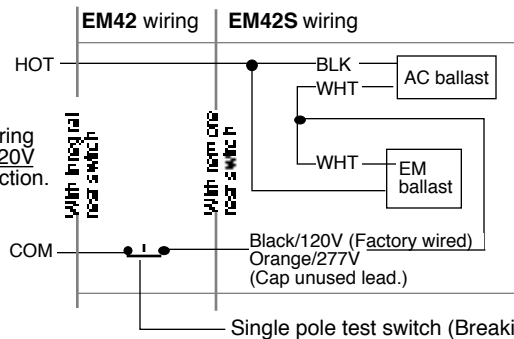

Note:

EM42 option is supplied with integral test switch and pilot light.

EM42S is supplied with additional wiring for external remotely installed test switch and pilot light.