

## G62FP

### CMOS Positive Voltage Regulator

#### Description

The G62FP series is a group of positive voltage output, three-pin regulators, that provide a high current even when the input/output voltage differential is small. Low power consumption and high accuracy is achieved through CMOS and laser trimming technologies.

The G62FP consists of a high-precision voltage reference, an error amplification circuit, and a current limited output driver. Transient response to load variations have improved in comparison to the existing series.

#### Features

- Maximum Output Current: 250mA (within max. power dissipation,  $V_{out}=5.0V$ )
- Output Voltage Range: 1.5V ~ 6V in 0.1V increments
- Low Power Consumption: Typ. 2.0uA @  $V_{OUT}=5.0V$
- Output Voltage Temperature Characteristics: Typ.  $\pm 100\text{ppm}/^\circ\text{C}$
- Input Stability: Typ. 0.2%/V
- Small Input-Output Differential:  $I_{OUT}=100\text{mA}$  @  $V_{OUT}=5.0V$  with a 0.12V differential
- Highly Accurate: Output voltage  $\pm 2\%$

#### Applications

- Battery Powered Equipment
- Palmtops
- Portable Cameras and Video Recorders
- Reference Voltage Source

#### Package Dimensions

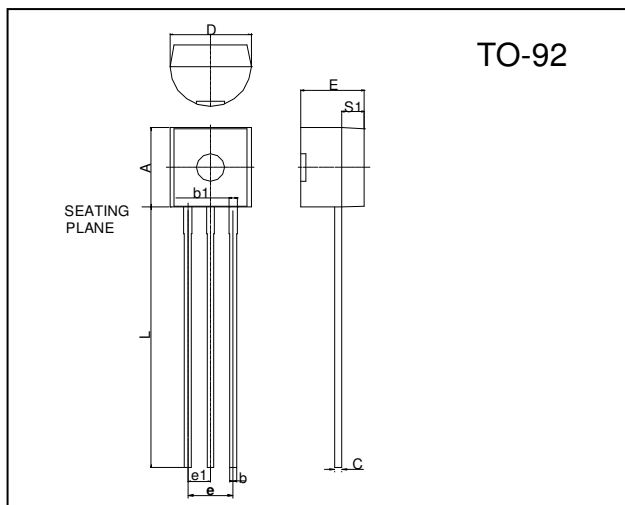

#### Marking :

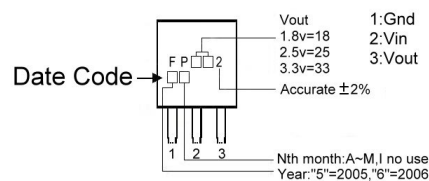

REF.	Millimeter		REF.	Millimeter	
	Min.	Max.		Min.	Max.
A	4.45	4.7	D	4.44	4.7
S1	1.02	-	E	3.30	3.81
b	0.36	0.51	L	12.70	-
b1	0.36	0.76	e1	1.150	1.390
C	0.36	0.51	e	2.42	2.66

#### Typical Application Circuit

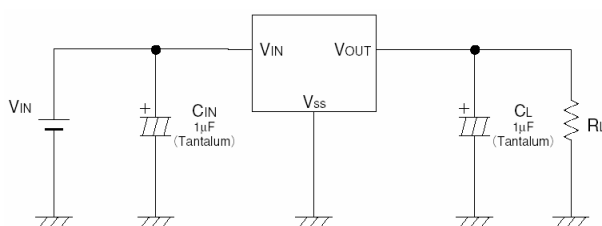

#### Block Diagram

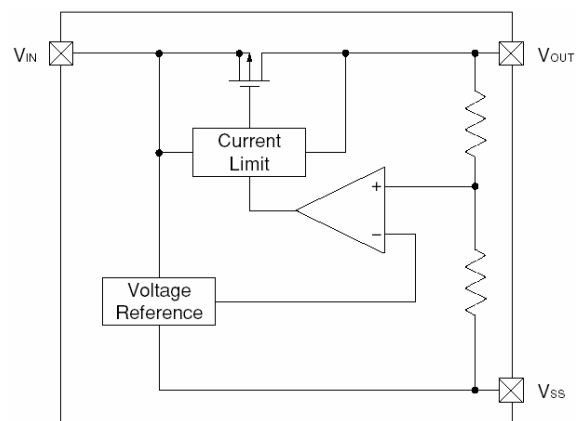

**Absolute Maximum Ratings Ta=25°C**

Parameter	Symbol	Ratings	Unit
Input Voltage	V <sub>IN</sub>	12	V
Output Current	I <sub>OUT</sub>	500	mA
Output Voltage	V <sub>OUT</sub>	V <sub>SS</sub> -0.3 ~V <sub>IN</sub> +0.3	V
Operating Ambient Temperature	Topr	-40 ~ +85	°C
Storage Temperature	Tstg	-40 ~ +125	°C
Continuous Total Power Dissipation	PD	300	mW

**Electrical Characteristics Ta=25°C****G62FP-50 V<sub>OUT</sub> (T) =5.0V (Note1)**

Parameter	Symbol	Condition	Min	TYP	Max	Unit
Output Voltage	V <sub>OUT</sub> (E) (Note2)	V <sub>IN</sub> =6.0V, I <sub>OUT</sub> =40mA	4.900	5.000	5.100	V
Max. Output Current	I <sub>OUT max</sub>	V <sub>IN</sub> =6V, V <sub>OUT</sub> (E)≥4.5V	250	-	-	mA
Load Stability	ΔV <sub>OUT</sub>	V <sub>IN</sub> =6V, I <sub>OUT</sub> =1mA to 100mA	-	40	80	mV
Input-Output Voltage Differential (Note3)	V <sub>dif1</sub>	I <sub>OUT</sub> =100mA	-	120	300	mV
	V <sub>dif2</sub>	I <sub>OUT</sub> =200mA	-	380	600	
Supply Current	I <sub>SS</sub>	V <sub>IN</sub> =6V	-	2.0	5.0	μA
Input Stability	$\frac{\Delta V_{OUT}}{\Delta V_{IN} \cdot V_{OUT}}$	I <sub>OUT</sub> =40mA V <sub>IN</sub> =6V to 10V	-	0.2	0.3	%/V
Input Voltage	V <sub>IN</sub>		-	-	10	V
Output Voltage Temperature Characteristics	$\frac{\Delta V_{OUT}}{\Delta T_{opr} \cdot V_{OUT}}$	I <sub>OUT</sub> =40mA -40°C ≤ Topr ≤ 85°C	-	±100	-	ppm/°C

Note 1: V<sub>OUT</sub> (T) =Specified Output Voltage.

2: V<sub>OUT</sub> (E) =Effective Output Voltage (i.e. the output voltage when "V<sub>OUT</sub> (T) +1.0V" is provided at the V<sub>IN</sub> pin while maintaining a certain I<sub>OUT</sub> value).

3: V<sub>dif</sub>=V<sub>IN</sub> (Note4) -V<sub>OUT</sub> (E)

4: V<sub>IN1</sub>=The input voltage at the time 98% of V<sub>OUT</sub> (E) is output (input voltage has been gradually reduced).

**G62FP-40 V<sub>OUT</sub> (T) =4.0V (Note1)**

Parameter	Symbol	Condition	Min	TYP	Max	Unit
Output Voltage	V <sub>OUT</sub> (E) (Note2)	V <sub>IN</sub> =5.0V, I <sub>OUT</sub> =40mA	3.920	4.000	4.080	V
Max. Output Current	I <sub>OUT max</sub>	V <sub>IN</sub> =5V, V <sub>OUT</sub> (E)≥3.6V	200	-	-	mA
Load Stability	ΔV <sub>OUT</sub>	V <sub>IN</sub> =5V, I <sub>OUT</sub> =1mA to 100mA	-	45	90	mV
Input-Output Voltage Differential (Note3)	V <sub>dif1</sub>	I <sub>OUT</sub> =100mA	-	170	330	mV
	V <sub>dif2</sub>	I <sub>OUT</sub> =200mA	-	400	630	
Supply Current	I <sub>SS</sub>	V <sub>IN</sub> =5V	-	2.0	4.5	μA
Input Stability	$\frac{\Delta V_{OUT}}{\Delta V_{IN} \cdot V_{OUT}}$	I <sub>OUT</sub> =40mA V <sub>IN</sub> =5V to 10V	-	0.2	0.3	%/V
Input Voltage	V <sub>IN</sub>		-	-	10	V
Output Voltage Temperature Characteristics	$\frac{\Delta V_{OUT}}{\Delta T_{opr} \cdot V_{OUT}}$	I <sub>OUT</sub> =40mA -40°C ≤ Topr ≤ 85°C	-	±100	-	ppm/°C

**G62FP-30 V<sub>OUT</sub> (T) =3.0V (Note1)**

Parameter	Symbol	Condition	Min	TYP	Max	Unit
Output Voltage	V <sub>OUT(E)</sub> (Note2)	V <sub>IN</sub> =4.0V, I <sub>OUT</sub> =40mA	2.940	3.000	3.060	V
Max. Output Current	I <sub>OUT max</sub>	V <sub>IN</sub> =4V, V <sub>OUT(E)</sub> ≥2.7V	150	-	-	mA
Load Stability	ΔV <sub>OUT</sub>	V <sub>IN</sub> =4V, I <sub>OUT</sub> =1mA to 80mA	-	45	90	mV
Input-Output Voltage Differential (Note3)	V <sub>dif1</sub>	I <sub>OUT</sub> =80mA	-	180	360	mV
	V <sub>dif2</sub>	I <sub>OUT</sub> =160mA	-	400	700	
Supply Current	I <sub>SS</sub>	V <sub>IN</sub> =4V	-	2.0	4.5	μA
Input Stability	$\frac{\Delta V_{OUT}}{\Delta V_{IN} \cdot V_{OUT}}$	I <sub>OUT</sub> =40mA V <sub>IN</sub> =4V to 10V	-	0.2	0.3	%/V
Input Voltage	V <sub>IN</sub>		-	-	10	V
Output Voltage Temperature Characteristics	$\frac{\Delta V_{OUT}}{\Delta T_{opr} \cdot V_{OUT}}$	I <sub>OUT</sub> =40mA -40°C ≤ T <sub>opr</sub> ≤ 85°C	-	±100	-	ppm/°C

**G62FP-20 V<sub>OUT</sub> (T) =2.0V (Note1)**

Parameter	Symbol	Condition	Min	TYP	Max	Unit
Output Voltage	V <sub>OUT(E)</sub> (Note2)	V <sub>IN</sub> =3.0V, I <sub>OUT</sub> =40mA	1.960	2.000	2.040	V
Max. Output Current	I <sub>OUT max</sub>	V <sub>IN</sub> =3V, V <sub>OUT(E)</sub> ≥1.8V	100	-	-	mA
Load Stability	ΔV <sub>OUT</sub>	V <sub>IN</sub> =3V, I <sub>OUT</sub> =1mA to 60mA	-	45	90	mV
Input-Output Voltage Differential (Note3)	V <sub>dif1</sub>	I <sub>OUT</sub> =60mA	-	180	360	mV
	V <sub>dif2</sub>	I <sub>OUT</sub> =120mA	-	400	700	
Supply Current	I <sub>SS</sub>	V <sub>IN</sub> =3V	-	2.0	4.5	μA
Input Stability	$\frac{\Delta V_{OUT}}{\Delta V_{IN} \cdot V_{OUT}}$	I <sub>OUT</sub> =40mA V <sub>IN</sub> =3V to 10V	-	0.2	0.3	%/V
Input Voltage	V <sub>IN</sub>		-	-	10	V
Output Voltage Temperature Characteristics	$\frac{\Delta V_{OUT}}{\Delta T_{opr} \cdot V_{OUT}}$	I <sub>OUT</sub> =40mA -40°C ≤ T <sub>opr</sub> ≤ 85°C	-	±100	-	ppm/°C

## Test Circuit

Circuit1

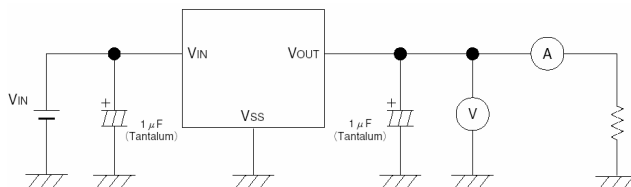

Circuit2

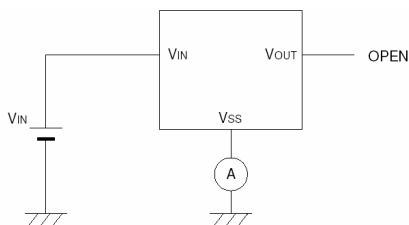

## Characteristics Curve

### (1) Output Voltage vs. Output Current

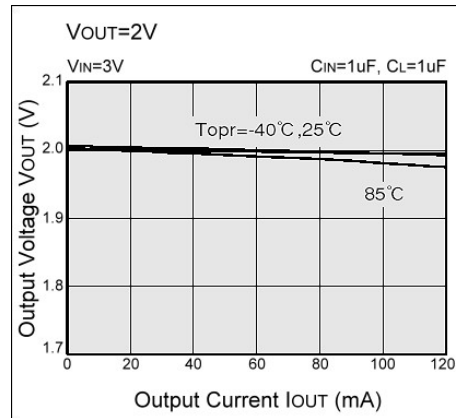
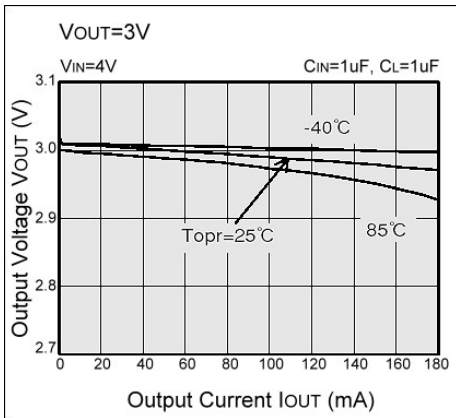
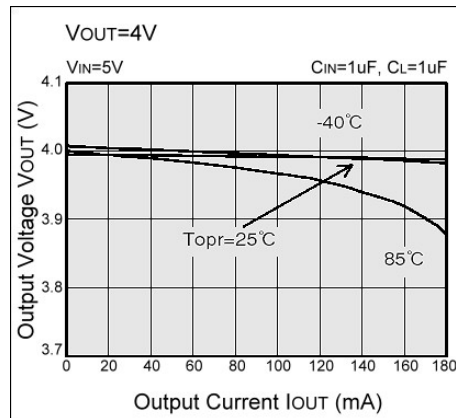
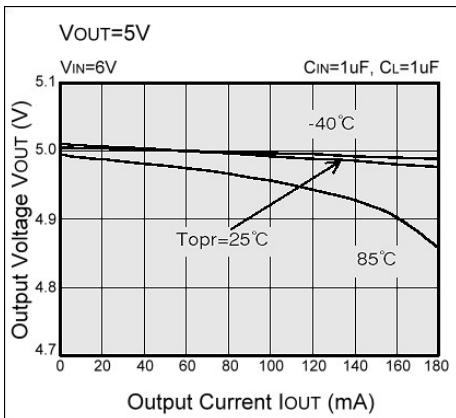

### (2) Output Voltage vs. Input Voltage

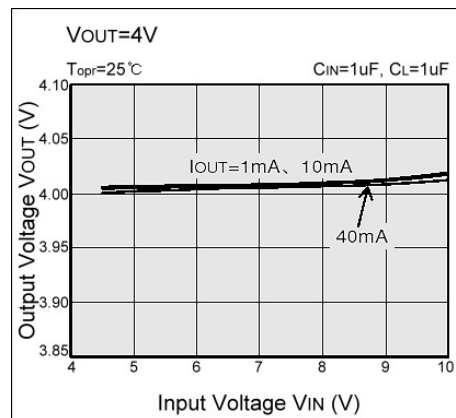
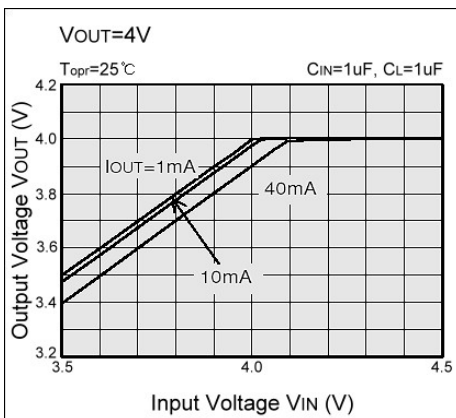
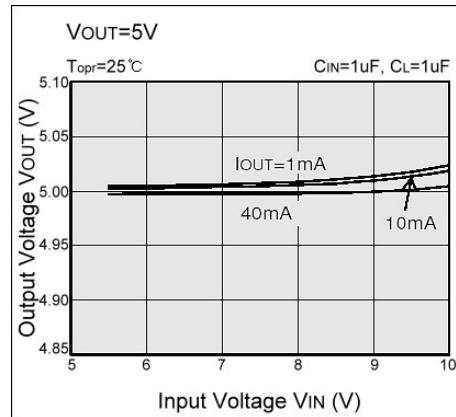
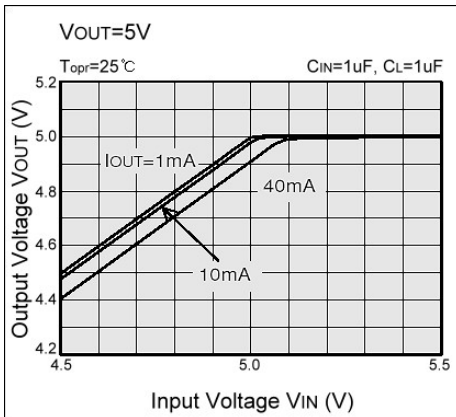

## (2) Output Voltage vs. Input Voltage

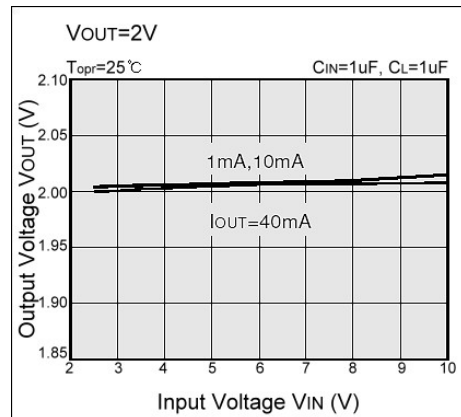
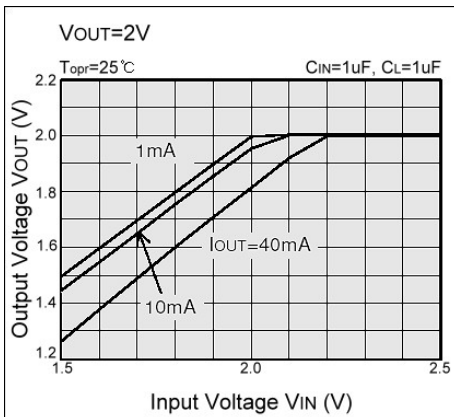
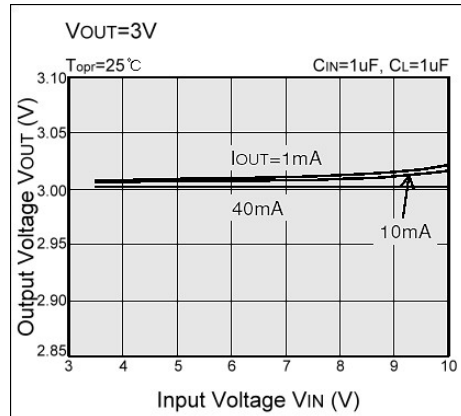
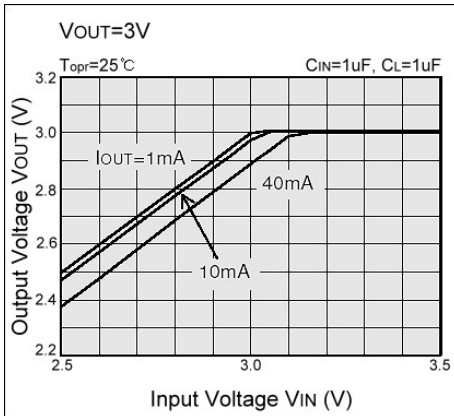

## (3) Input/Output Voltage Differential vs. Output Current

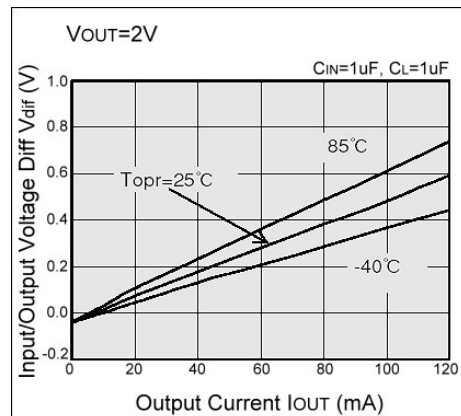
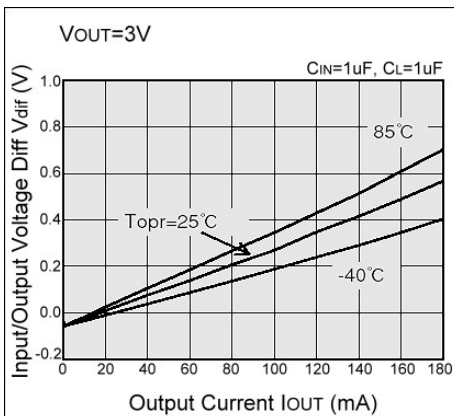
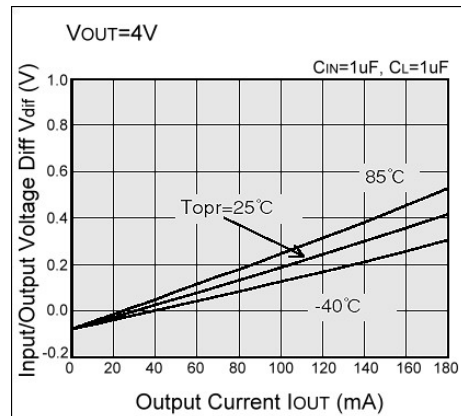
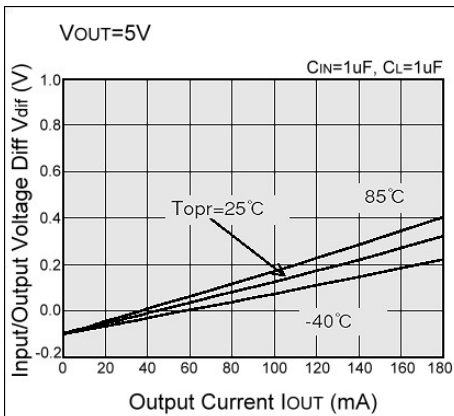

### (4) Supply Current vs. Input Voltage

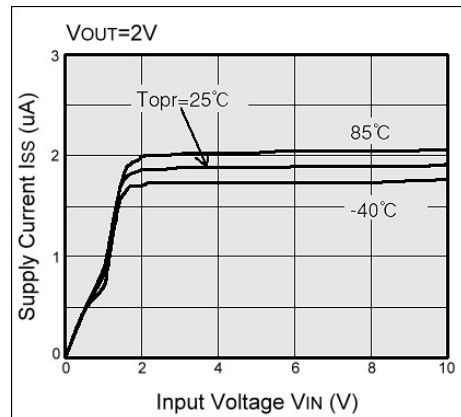
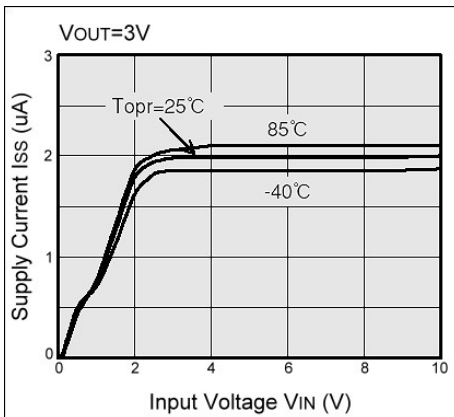
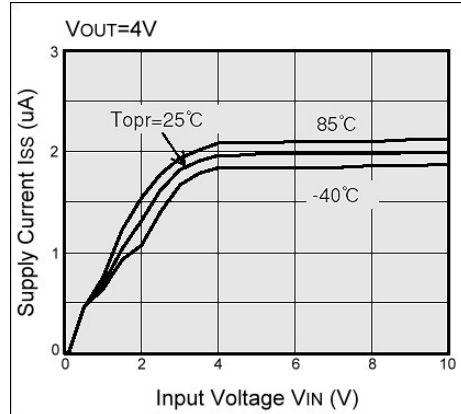
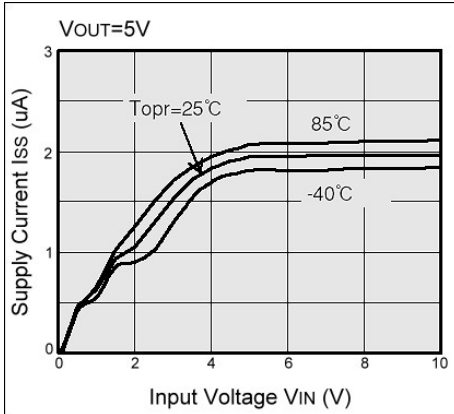

### (5) Supply Current vs. Ambient Temperature

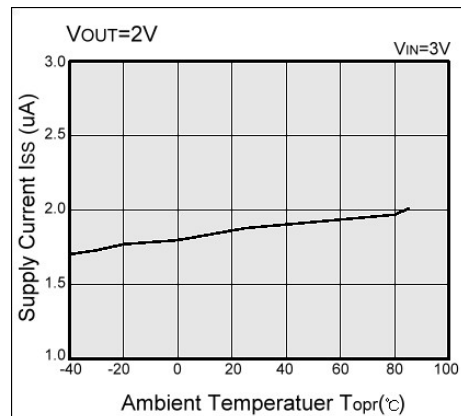
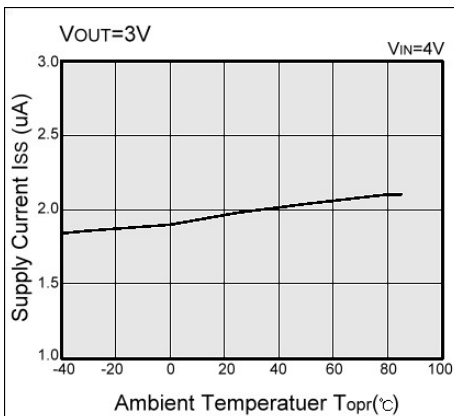
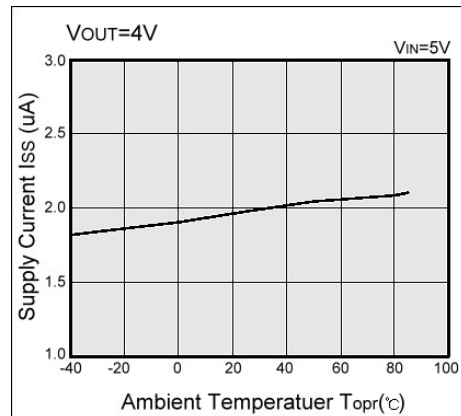
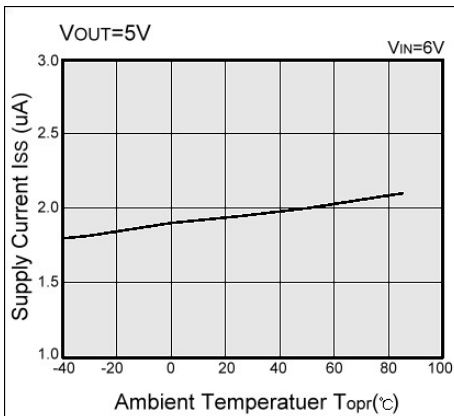

## (6) Output Voltage vs. Ambient Temperature

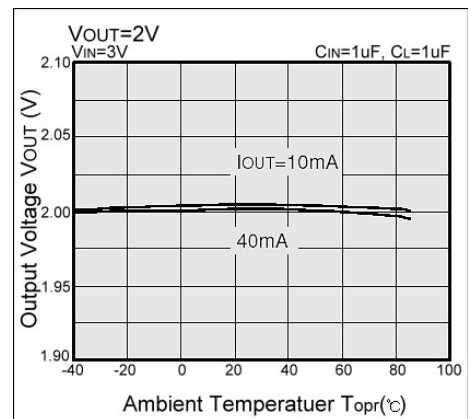
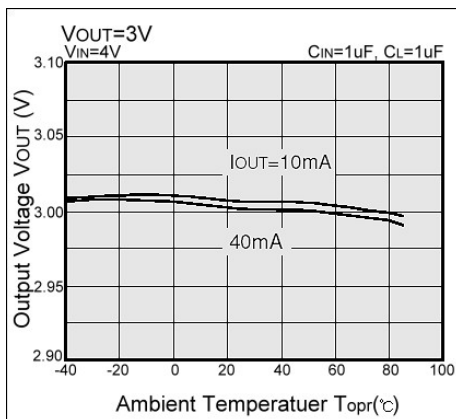
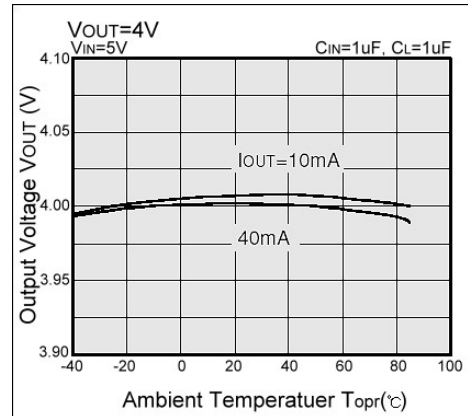
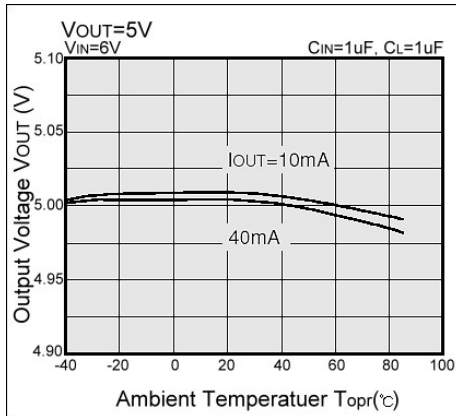

**Important Notice:**

- All rights are reserved. Reproduction in whole or in part is prohibited without the prior written approval of GTM.
- GTM reserves the right to make changes to its products without notice.
- GTM semiconductor products are not warranted to be suitable for use in life-support Applications, or systems.
- GTM assumes no liability for any consequence of customer product design, infringement of patents, or application assistance.

**Head Office And Factory:**

- **Taiwan:** No. 17-1 Tatung Rd. Fu Kou Hsin-Chu Industrial Park, Hsin-Chu, Taiwan, R. O. C.
- TEL : 886-3-597-7061 FAX : 886-3-597-9220, 597-0785
- **China:** (201203) No.255, Jang-Jiang Tsai-Lueng RD. , Pu-Dung-Hsin District, Shang-Hai City, China
- TEL : 86-21-5895-7671 ~ 4 FAX : 86-21-38950165