

EVALUATION KIT  
AVAILABLE

# Low-Cost, Mono/Stereo, 1.4W Differential Audio Power Amplifiers

## General Description

The MAX9718/MAX9719 differential input audio power amplifiers are ideal for portable audio devices with internal speakers. The differential input structure improves noise rejection and provides common-mode rejection. A bridge-tied load (BTL) architecture minimizes external component count, while providing high-quality, power audio amplification. The MAX9718 is a single-channel amplifier while the MAX9719 is a dual-channel amplifier for stereo systems. Both devices deliver 1.4W continuous average power per channel to a 4Ω load with less than 1% THD+N while operating from a single +5V supply. The devices are available as adjustable gain amplifiers or with internally fixed gains of 0dB, 3dB, and 6dB to reduce component count.

A shutdown input disables the bias generator and amplifiers and reduces quiescent current consumption to less than 100nA. The MAX9718 shutdown input can be set as active high or active low. These devices feature Maxim's comprehensive click-and-pop suppression circuitry that reduces audible clicks and pops during startup and shutdown.

The MAX9718 is pin compatible with the LM4895, and is available in 9-bump UCSP™, 10-pin TDFN, and 10-pin μMAX® packages. The MAX9719 is available in 16-pin TQFN, 16-pin TSSOP, and 16-bump UCSP packages. Both devices operate over the -40°C to +85°C extended temperature range.

## Applications

Mobile Phones  
PDAs  
Portable Devices

## Features

- ◆ 2.7V to 5.5V Single-Supply Operation
- ◆ Very High -93dB PSRR at 217Hz
- ◆ 1.4W into 4Ω at 1% THD+N (per Channel)
- ◆ Differential Input
- ◆ Internal Fixed Gain to Reduce Component Count
- ◆ Adjustable Gain Option (MAX9718A/H/MAX9719A)
- ◆ 100nA Low-Power Shutdown Mode
- ◆ No Audible Clicks or Pops at Power-Up/Down
- ◆ Improved Performance Pin-Compatible Upgrade to LM4895 (MAX9718D/G)
- ◆ 1.8V Logic Compatible

## Ordering Information

PART	TEMP RANGE	PIN-PACKAGE	TOP MARK
MAX9718AEBL-T	-40°C to +85°C	3 x 3 UCSP	ADX
MAX9718AEBL+T	-40°C to +85°C	3 x 3 UCSP	+ADX
MAX9718AETB-T	-40°C to +85°C	10 TDFN-EP*	AAV

+Denotes lead-free package.

\*EP = Exposed paddle.

Ordering Information continued at end of data sheet.

Pin Configurations appear at end of data sheet.

UCSP is a trademark of Maxim Integrated Products, Inc.

μMAX is a registered trademark of Maxim Integrated Products, Inc.

## Simplified Block Diagrams

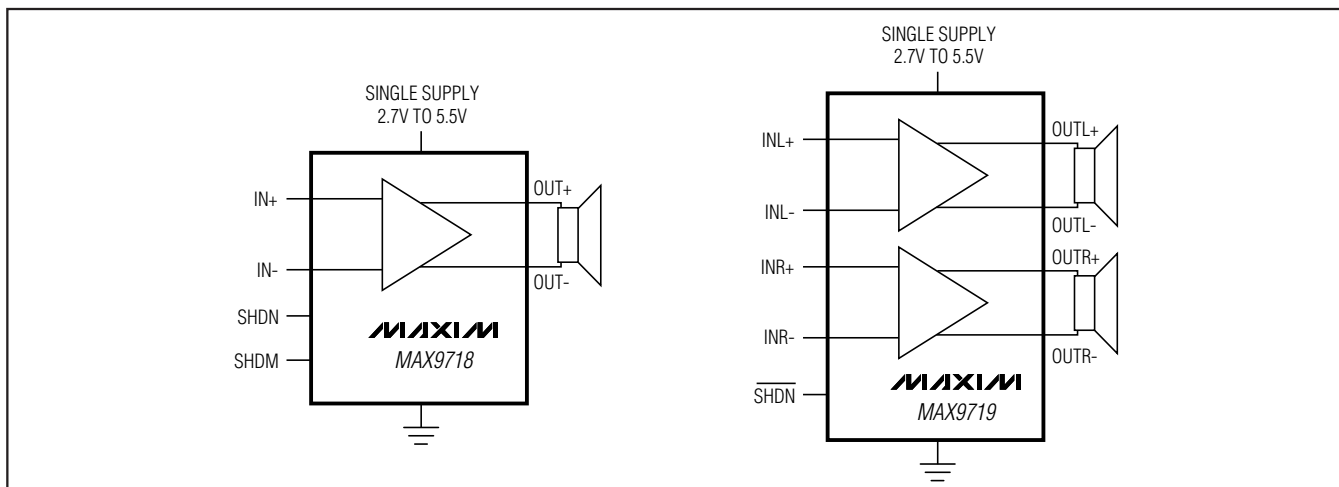

# Low-Cost, Mono/Stereo, 1.4W Differential Audio Power Amplifiers

## ABSOLUTE MAXIMUM RATINGS

Supply Voltage (V <sub>CC</sub> to GND)	-0.3V to +6V
Any Other Pin to GND	-0.3V to (V <sub>CC</sub> + 0.3V)
IN <sub>-</sub> , BIAS, SHDM, SHDN, SHDN Continuous Current	20mA
OUT <sub>-</sub> Short-Circuit Duration to GND or V <sub>CC</sub>	Continuous
Continuous Power Dissipation (T <sub>A</sub> = +70°C)	
9-Bump UCSP (derate 5.2mW/°C above +70°C)	412mW
10-Pin TDFN (derate 24.4mW/°C above +70°C)	1951mW
10-Pin μMAX (derate 10.3mW/°C above +70°C)	825mW
16-Bump UCSP (derate 8.2mW/°C above +70°C)	659mW
16-Pin TQFN (derate 16.9mW/°C above +70°C)	1349mW
16-Pin TSSOP (derate 21.3mW/°C above +70°C)	1702mW

Operating Temperature Range	-40°C to +85°C
Junction Temperature	+150°C
Storage Temperature Range	-65°C to +150°C
Bump Temperature (soldering) Reflow	+235°C
Lead Temperature (soldering, 10s)	+300°C

Stresses beyond those listed under "Absolute Maximum Ratings" may cause permanent damage to the device. These are stress ratings only, and functional operation of the device at these or any other conditions beyond those indicated in the operational sections of the specifications is not implied. Exposure to absolute maximum rating conditions for extended periods may affect device reliability.

## ELECTRICAL CHARACTERISTICS—5V Supply

(V<sub>CC</sub> = 5V, GND = 0, SHDN/SHDN = V<sub>CC</sub> (MAX9718/MAX9719), SHDM = GND (MAX9718), R<sub>IN</sub> = R<sub>F</sub> = 10kΩ (MAX971\_A/H), T<sub>A</sub> = +25°C. C<sub>BIAS</sub> = 0.1μF, no load. Typical values are at T<sub>A</sub> = +25°C, unless otherwise noted.) (Note 1)

PARAMETER	SYMBOL	CONDITIONS		MIN	TYP	MAX	UNITS
Supply Voltage	V <sub>CC</sub>			2.7		5.5	V
Supply Current	I <sub>CC</sub>	V <sub>IN-</sub> = V <sub>IN+</sub> = V <sub>BIAS</sub> , T <sub>A</sub> = -40°C to +85°C, per amplifier (Note 2)			5.0	7.5	mA
Shutdown Supply Current	I <sub>SHDN</sub>	SHDN = SHDM = SHDN = GND, per amplifier			0.1	1	μA
SHDN, SHDN, SHDM Threshold	V <sub>IH</sub>	MAX9718A/B/C/D		0.7 x V <sub>CC</sub>			V
	V <sub>IL</sub>			0.3 x V <sub>CC</sub>			
SHDN, SHDN, SHDM Threshold	V <sub>IH</sub>	MAX9718E/F/G/H		1.4			V
	V <sub>IL</sub>			0.4			
Output Offset Voltage	V <sub>OS</sub>	V <sub>IN-</sub> = V <sub>IN+</sub> = V <sub>BIAS</sub>	A <sub>V</sub> = 0dB, MAX971_A/H, MAX971_B/E		±1	±10	mV
			A <sub>V</sub> = 3dB, MAX971_C/F		±1	±15	
			A <sub>V</sub> = 6dB, MAX971_D/G		±1	±20	
Common-Mode Input Voltage	V <sub>IC</sub>	Inferred from CMRR test	A <sub>V</sub> = 0dB, MAX971_B/E	0.5		V <sub>CC</sub> - 0.5	V
			A <sub>V</sub> = 3dB, MAX971_C/F	0.5		V <sub>CC</sub> - 0.6	
			A <sub>V</sub> = 6dB, MAX971_D/G	0.5		V <sub>CC</sub> - 0.8	
		External gain, MAX971_A/H	0.5		V <sub>CC</sub> - 1.2		
Input Impedance	R <sub>IN</sub>	MAX971_B/E, MAX971_C/F, MAX971_D/G		10	15	20	kΩ
Common-Mode Rejection Ratio	CMRR			-50	-60		dB
		f <sub>N</sub> = 1kHz			-60		
Power-Supply Rejection Ratio	PSRR	V <sub>IN-</sub> = V <sub>IN+</sub> = V <sub>BIAS</sub> , V <sub>RIPPLE</sub> = 200mV <sub>P-P</sub> , R <sub>L</sub> = 8Ω, C <sub>BIAS</sub> = 1μF	f = 217Hz		-93		dB
			f = 1kHz		-90		
Output Power	P <sub>OUT</sub>	THD+N = 1%, f <sub>IN</sub> = 1kHz (Note 4)	R <sub>L</sub> = 8Ω	0.8	1.1		W
			R <sub>L</sub> = 4Ω		1.4		
Total Harmonic Distortion Plus Noise	THD+N	R <sub>L</sub> = 8Ω, f <sub>IN</sub> = 1kHz, P <sub>OUT</sub> = 0.75W, V <sub>CC</sub> = 5V, A <sub>V</sub> = 6dB (Note 5)			0.002		%

# Low-Cost, Mono/Stereo, 1.4W Differential Audio Power Amplifiers

MAX9718/MAX9719

## ELECTRICAL CHARACTERISTICS—5V Supply (continued)

( $V_{CC} = 5V$ ,  $GND = 0$ ,  $\overline{SHDN}/\overline{SHDN} = V_{CC}$  (MAX9718/MAX9719),  $\overline{SHDM} = GND$  (MAX9718),  $R_{IN} = R_F = 10k\Omega$  (MAX971\_A/H),  $T_A = +25^\circ C$ .  $C_{BIAS} = 0.1\mu F$ , no load. Typical values are at  $T_A = +25^\circ C$ , unless otherwise noted.) (Note 1)

PARAMETER	SYMBOL	CONDITIONS	MIN	TYP	MAX	UNITS
Gain Accuracy		MAX971_B/E, MAX971_C/F, MAX971_D/G			$\pm 1$	%
Channel-to-Channel Gain Matching		MAX9719B/E, MAX9719C/F, MAX9719D/G			$\pm 1$	%
Signal-to-Noise Ratio	SNR	$P_{OUT} = 1W$ , $R_L = 8\Omega$		-104		dB
Thermal-Shutdown Threshold				+160		$^\circ C$
Thermal-Shutdown Hysteresis				15		$^\circ C$
Maximum Capacitive Drive	$C_{LOAD}$	Bridge-tied capacitance		500		pF
Power-Up/Enable from Shutdown Time	$t_{PU}$			10		ms
Shutdown Time	$t_{SHDN}$			3.5		$\mu s$
Turn-Off Transient	$V_{POP}$	(Note 6)		50		mV
Crosstalk		MAX9719, $f_{IN} = 1kHz$		-85		dB

## ELECTRICAL CHARACTERISTICS—3V Supply

( $V_{CC} = 3V$ ,  $GND = 0$ ,  $\overline{SHDN}/\overline{SHDN} = V_{CC}$  (MAX9718/MAX9719),  $\overline{SHDM} = GND$  (MAX9718),  $R_{IN} = R_F = 10k\Omega$  (MAX971\_A/H),  $T_A = +25^\circ C$ .  $C_{BIAS} = 0.1\mu F$ , no load. Typical values are at  $T_A = +25^\circ C$ , unless otherwise noted.) (Note 1)

PARAMETER	SYMBOL	CONDITIONS	MIN	TYP	MAX	UNITS
Supply Current	$I_{CC}$	$V_{IN-} = V_{IN+} = V_{BIAS}$ , $T_A = -40^\circ C$ to $+85^\circ C$ , per amplifier (Note 2)		3.8	6.0	mA
Shutdown Supply Current	$I_{SHDN}$	$\overline{SHDN} = \overline{SHDM} = \overline{SHDN} = GND$ , per amplifier		0.1	1	$\mu A$
$\overline{SHDN}$ , SHDN, SHDM Threshold	$V_{IH}$		$0.7 \times V_{CC}$			V
	$V_{IL}$		$0.3 \times V_{CC}$			
Common-Mode Bias Voltage	$V_{BIAS}$	(Note 3)	$V_{CC}/2 - 5\%$	$V_{CC}/2$	$V_{CC}/2 + 5\%$	V
Output Offset Voltage	$V_{OS}$	$V_{IN-} = V_{IN+} = V_{BIAS}$	$A_V = 0dB$ , MAX971_A/H MAX971_B/E	$\pm 1$	$\pm 10$	mV
			$A_V = 3dB$ , MAX971_C/F	$\pm 1$	$\pm 15$	
			$A_V = 6dB$ , MAX971_D/G	$\pm 1$	$\pm 20$	
Common-Mode Input Voltage	$V_{IC}$	Inferred from CMRR test	$A_V = 0dB$ , MAX971_B/E	0.5	$V_{CC} - 0.7$	V
			$A_V = 3dB$ , MAX971_C/F	0.5	$V_{CC} - 0.8$	
			$A_V = 6dB$ , MAX971_D/G	0.5	$V_{CC} - 1.0$	
		External gain, MAX971_A/H	0.5	$V_{CC} - 1.2$		
Input Impedance	$R_{IN}$	MAX971_B/E, MAX971_C/F, MAX971_D/G	10	15	20	$k\Omega$
Common-Mode Rejection Ratio	CMRR		-50	-60		dB
		$f_N = 1kHz$		-70		
Power-Supply Rejection Ratio	PSRR	$V_{IN-} = V_{IN+} = V_{BIAS}$ , $V_{RIPPLE} = 200mV_{P-P}$ , $R_L = 8\Omega$ , $C_{BIAS} = 1\mu F$	$f = 217Hz$	-93		dB
			$f = 1kHz$	-90		

# Low-Cost, Mono/Stereo, 1.4W Differential Audio Power Amplifiers

## ELECTRICAL CHARACTERISTICS—3V Supply (continued)

( $V_{CC} = 3V$ ,  $GND = 0$ ,  $SHDN/SHDN\bar{N} = V_{CC}$  (MAX9718/MAX9719),  $SHDM = GND$  (MAX9718),  $R_{IN} = R_F = 10k\Omega$  (MAX971\_A/H),  $T_A = +25^\circ C$ .  $C_{BIAS} = 0.1\mu F$ , no load. Typical values are at  $T_A = +25^\circ C$ , unless otherwise noted.) (Note 1)

PARAMETER	SYMBOL	CONDITIONS	MIN	TYP	MAX	UNITS
Output Power	$P_{OUT}$	$R_L = 8\Omega$ , THD+N = 1%, $f_{IN} = 1kHz$ (Note 4)		475		mW
Total Harmonic Distortion Plus Noise	THD+N	$R_L = 8\Omega$ , $f_{IN} = 1kHz$ , $P_{OUT} = 0.25W$ , $A_V = 6dB$		0.003		%
Thermal-Shutdown Threshold				+160		$^\circ C$
Thermal-Shutdown Hysteresis				15		$^\circ C$
Maximum Capacitive Drive	$C_{LOAD}$	Bridge-tied capacitance		500		pF
Power-Up/Enable from Shutdown Time	$t_{PU}$			10		ms
Shutdown Time	$t_{SHDN}$			3		$\mu s$
Turn-Off Transient	$V_{POP}$	(Note 6)		40		mV
Crosstalk		MAX9719, $f_N = 1kHz$		-85		dB

- Note 1:** All specifications are 100% tested at  $T_A = +25^\circ C$ . Specifications over temperature ( $T_A = T_{MIN}$  to  $T_{MAX}$ ) are guaranteed by design, not production tested.
- Note 2:** Quiescent power-supply current is specified and tested with no load. Quiescent power-supply current depends on the offset voltage when a practical load is connected to the amplifier. Guaranteed by design.
- Note 3:** Common-mode bias voltage is the voltage on BIAS and is nominally  $V_{CC}/2$ .
- Note 4:** Output power is specified by a combination of a functional output current test and characterization analysis.
- Note 5:** Measurement bandwidth for THD+N is 22Hz to 22kHz.
- Note 6:** Peak voltage measured at power-on, power-off, into or out of SHDN. Bandwidth defined by A-weighted filters, inputs at AC GND.  $V_{CC}$  rise and fall times greater than or equal to 1ms.

## Typical Operating Characteristics

( $V_{CC} = 5V$ ,  $C_{BIAS} = 0.1\mu F$ , THD+N measurement bandwidth = 22Hz to 22kHz,  $T_A = +25^\circ C$ , unless otherwise noted.)

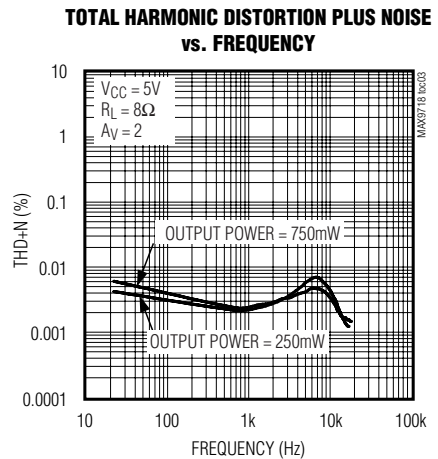
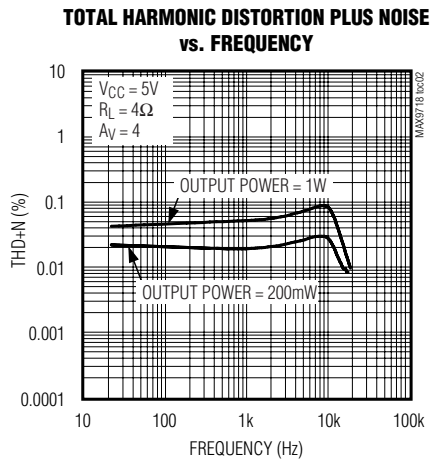
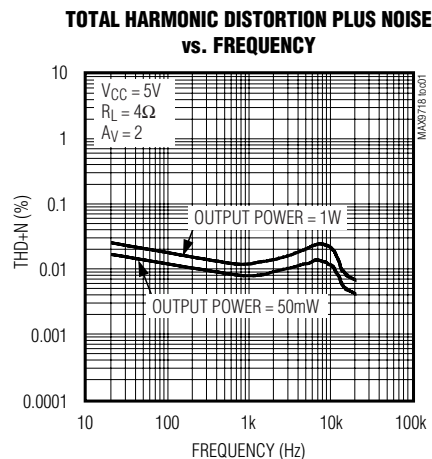

# Low-Cost, Mono/Stereo, 1.4W Differential Audio Power Amplifiers

## Typical Operating Characteristics (continued)

( $V_{CC} = 5V$ ,  $C_{BIAS} = 0.1\mu F$ , THD+N measurement bandwidth = 22Hz to 22kHz,  $T_A = +25^\circ C$ , unless otherwise noted.)

MAX9718/MAX9719

**TOTAL HARMONIC DISTORTION PLUS NOISE vs. FREQUENCY**

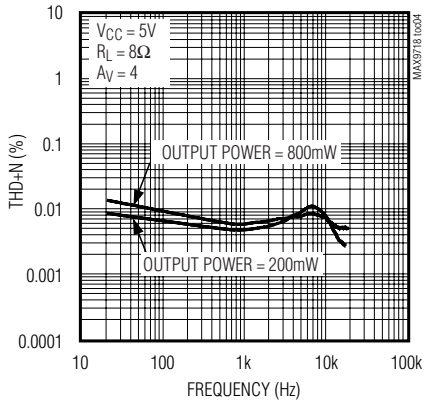

**TOTAL HARMONIC DISTORTION PLUS NOISE vs. FREQUENCY**

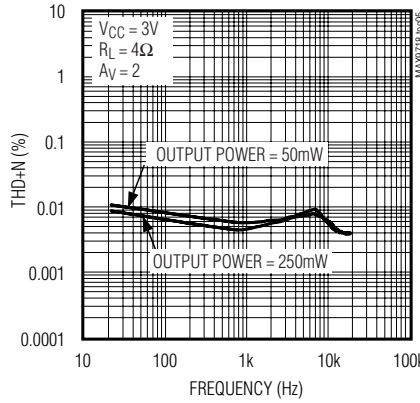

**TOTAL HARMONIC DISTORTION PLUS NOISE vs. FREQUENCY**

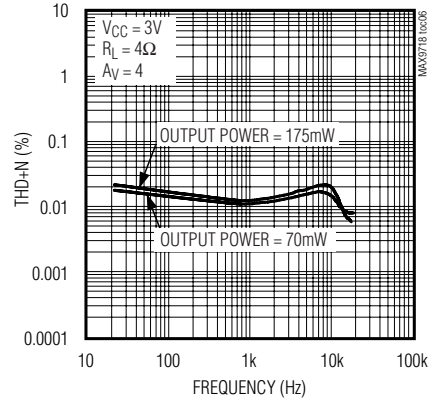

**TOTAL HARMONIC DISTORTION PLUS NOISE vs. FREQUENCY**

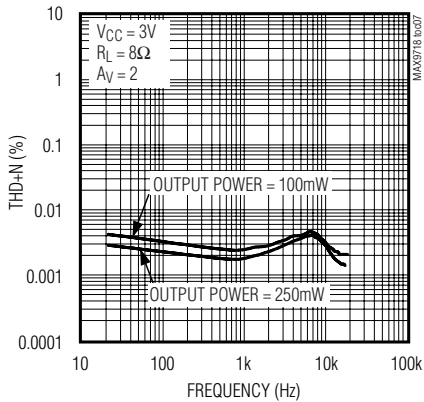

**TOTAL HARMONIC DISTORTION PLUS NOISE vs. FREQUENCY**

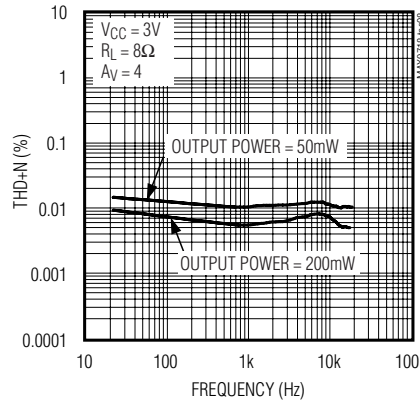

**TOTAL HARMONIC DISTORTION PLUS NOISE vs. OUTPUT POWER**

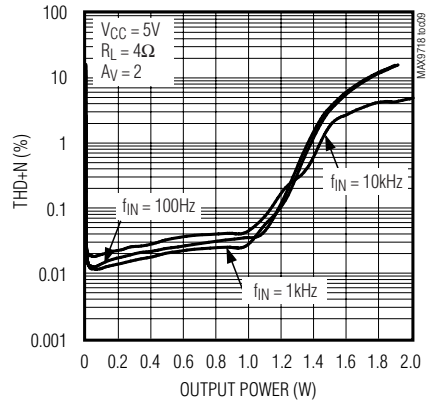

**TOTAL HARMONIC DISTORTION PLUS NOISE vs. OUTPUT POWER**

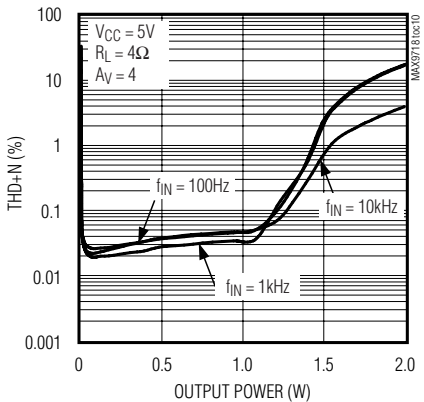

**TOTAL HARMONIC DISTORTION PLUS NOISE vs. OUTPUT POWER**

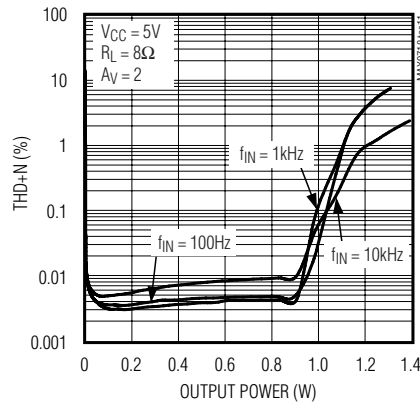

**TOTAL HARMONIC DISTORTION PLUS NOISE vs. OUTPUT POWER**

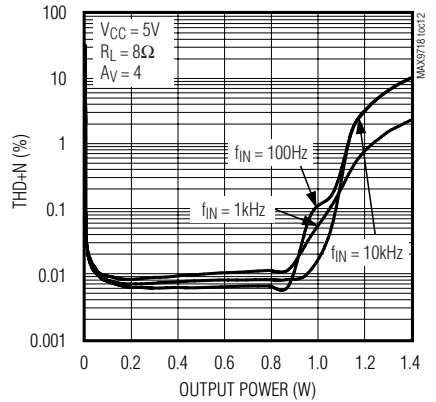

# Low-Cost, Mono/Stereo, 1.4W Differential Audio Power Amplifiers

## Typical Operating Characteristics (continued)

( $V_{CC} = 5V$ ,  $C_{BIAS} = 0.1\mu F$ , THD+N measurement bandwidth = 22Hz to 22kHz,  $T_A = +25^\circ C$ , unless otherwise noted.)

**TOTAL HARMONIC DISTORTION PLUS NOISE vs. OUTPUT POWER**

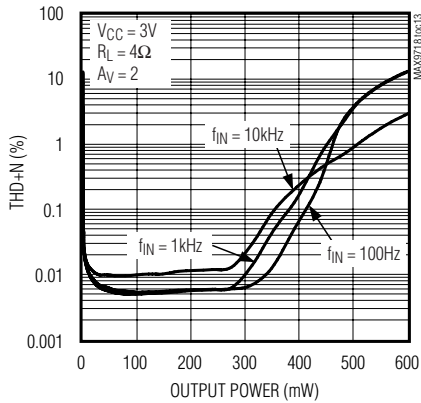

**TOTAL HARMONIC DISTORTION PLUS NOISE vs. OUTPUT POWER**

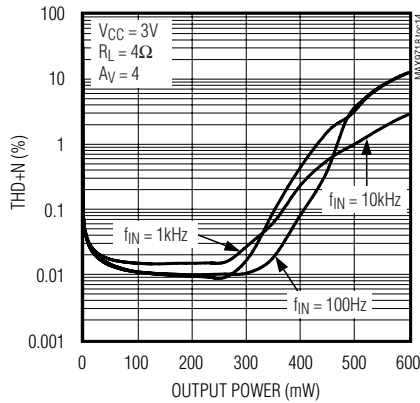

**TOTAL HARMONIC DISTORTION PLUS NOISE vs. OUTPUT POWER**

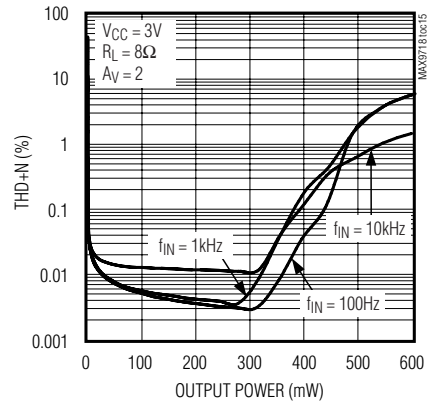

**TOTAL HARMONIC DISTORTION PLUS NOISE vs. OUTPUT POWER**

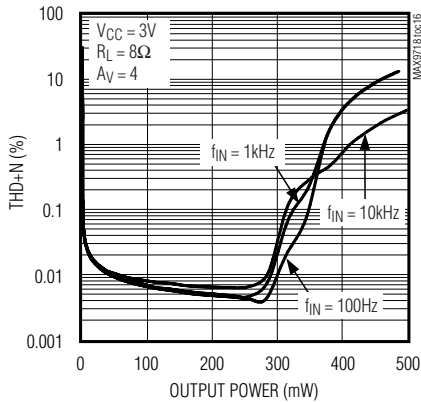

**TOTAL HARMONIC DISTORTION PLUS NOISE vs. COMMON-MODE VOLTAGE**

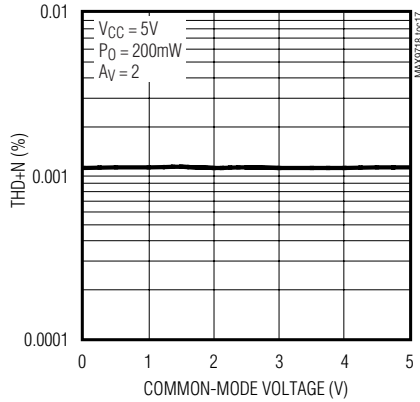

**TOTAL HARMONIC DISTORTION PLUS NOISE vs. COMMON-MODE VOLTAGE**

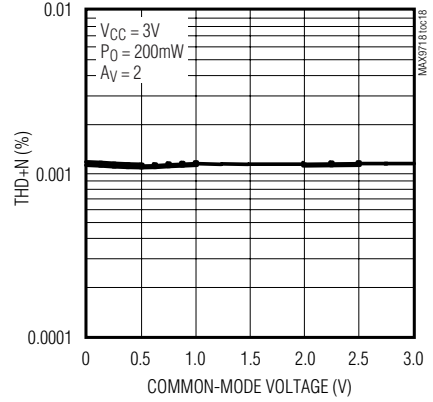

**OUTPUT POWER vs. SUPPLY VOLTAGE**

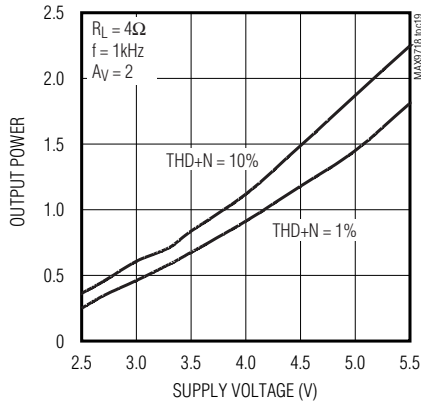

**OUTPUT POWER vs. SUPPLY VOLTAGE**

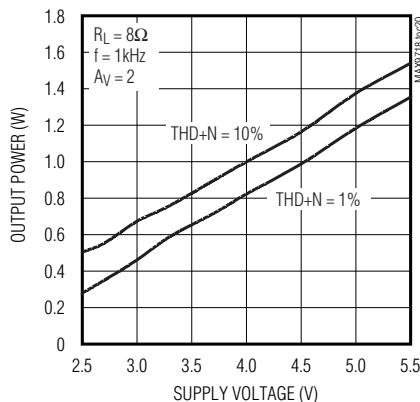

**OUTPUT POWER vs. LOAD RESISTANCE**

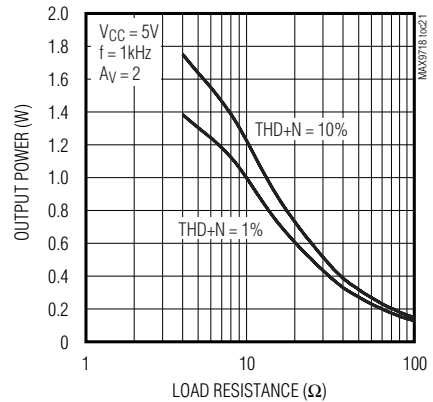

# Low-Cost, Mono/Stereo, 1.4W Differential Audio Power Amplifiers

## Typical Operating Characteristics (continued)

( $V_{CC} = 5V$ ,  $C_{BIAS} = 0.1\mu F$ , THD+N measurement bandwidth = 22Hz to 22kHz,  $T_A = +25^\circ C$ , unless otherwise noted.)

MAX9718/MAX9719

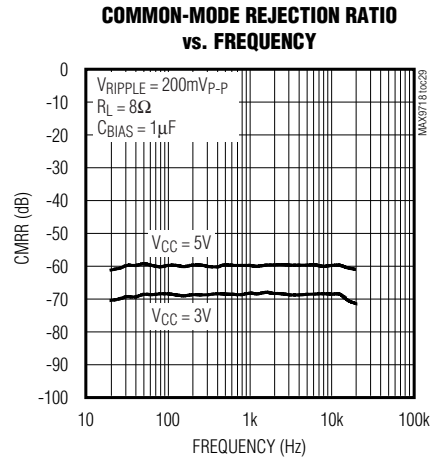
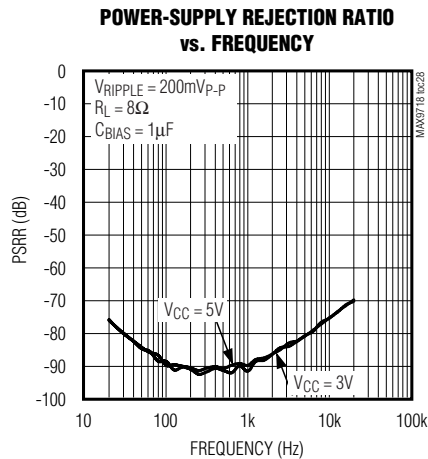
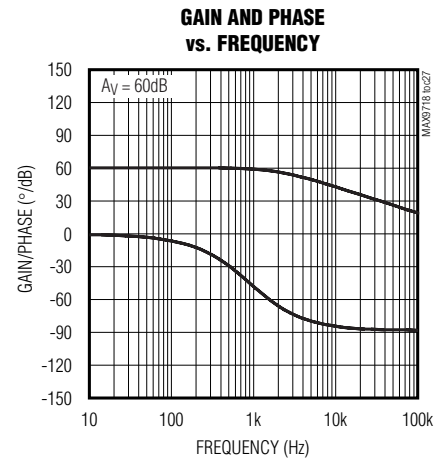
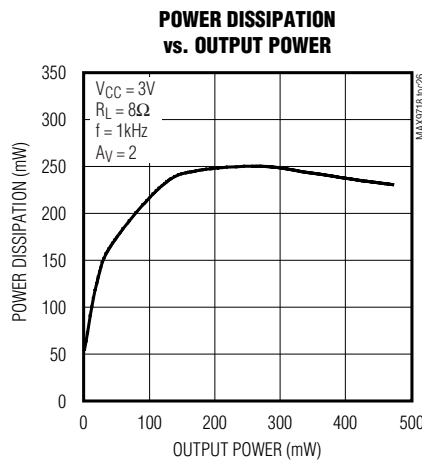
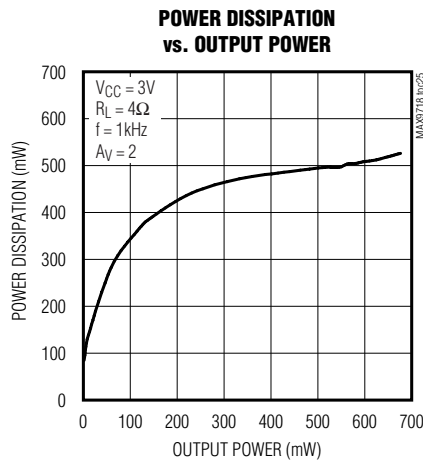
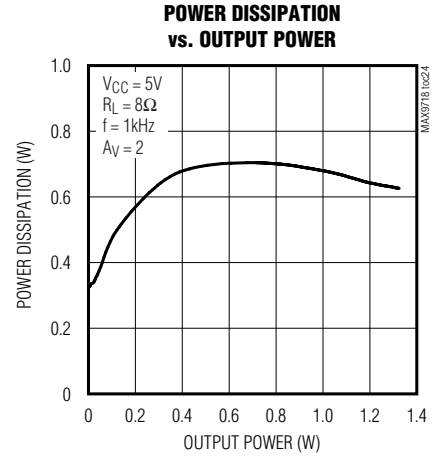
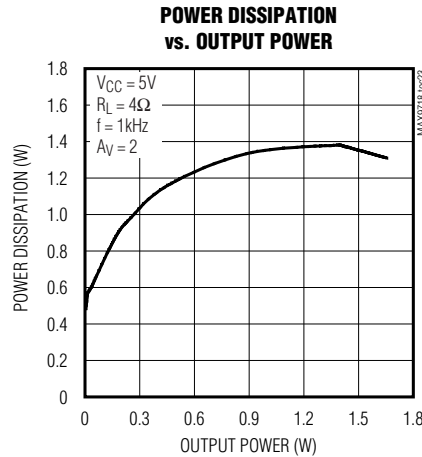
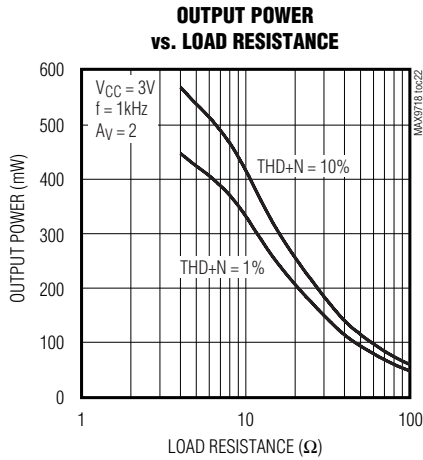

# Low-Cost, Mono/Stereo, 1.4W Differential Audio Power Amplifiers

## Typical Operating Characteristics (continued)

( $V_{CC} = 5V$ ,  $C_{BIAS} = 0.1\mu F$ , THD+N measurement bandwidth = 22Hz to 22kHz,  $T_A = +25^\circ C$ , unless otherwise noted.)

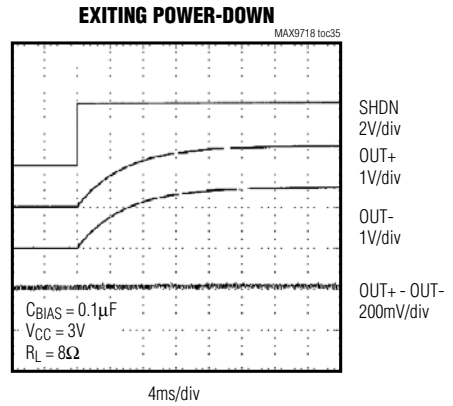
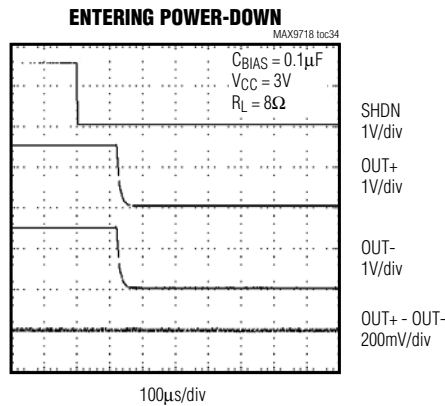
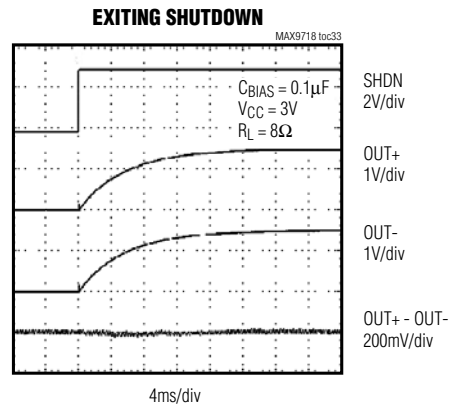
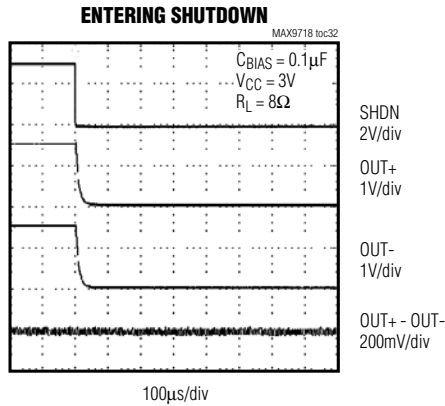
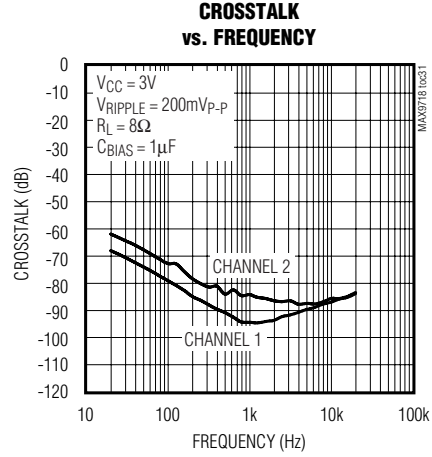
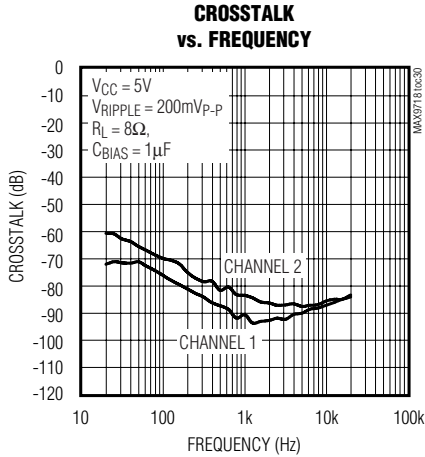



# Low-Cost, Mono/Stereo, 1.4W Differential Audio Power Amplifiers

## Typical Operating Characteristics (continued)

( $V_{CC} = 5V$ ,  $C_{BIAS} = 0.1\mu F$ , THD+N measurement bandwidth = 22Hz to 22kHz,  $T_A = +25^\circ C$ , unless otherwise noted.)

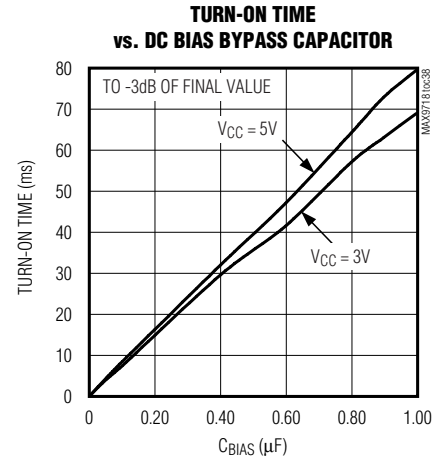
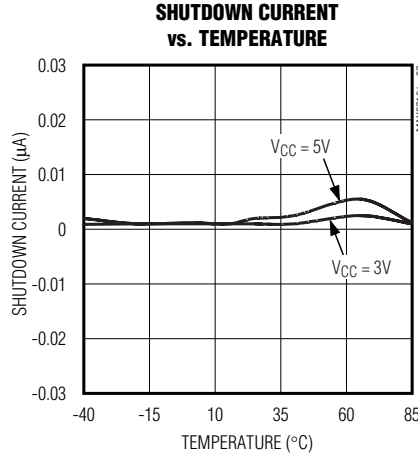
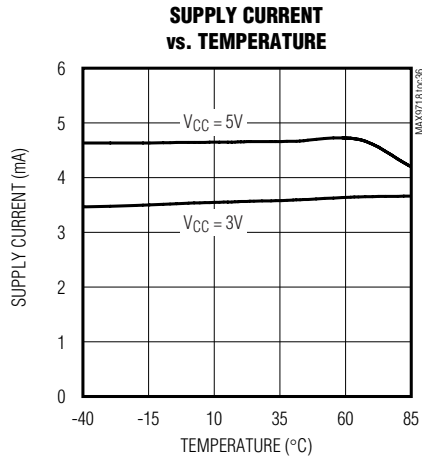

MAX9718/MAX9719

## Pin Description

PIN					NAME	FUNCTION
MAX9718		MAX9719				
TDFN/ $\mu$ MAX	UCSP	TQFN	UCSP	TSSOP		
1	C2	—	—	—	SHDN	Shutdown Input. The polarity of SHDN is dependent on the state of SHDM.
—	—	9	B3	11	$\overline{SHDN}$	Shutdown Input. Active-low shutdown input.
2	C1	—	—	—	IN-	Inverting Input
3	B2	—	—	—	SHDM	Shutdown-Mode Polarity Input. SHDM controls the polarity of SHDN. Connect SHDM high for an active-high SHDN input. Connect SHDM low for an active-low SHDN input (see Table 1).
4	A1	—	—	—	IN+	Noninverting Input
5	A2	5	B2	7	BIAS	DC Bias Bypass
6	A3	—	—	—	OUT-	Bridge Amplifier Negative Output
7	B3	1, 6, 11	A2, C2, C4	3, 8, 13	GND	Ground
8	—	13	—	15	N.C.	No Connection. Not internally connected.
9	B1	8, 14	A4, D3	16, 10	VCC	Power Supply
10	C3	—	—	—	OUT+	Bridge Amplifier Positive Output
—	—	2	C1	4	INR+	Right-Channel Noninverting Input
—	—	3	B1	5	INL-	Left-Channel Inverting Input
—	—	4	A1	6	INL+	Left-Channel Noninverting Input
—	—	7	A3	9	OUTL+	Left-Channel Bridge Amplifier Positive Output
—	—	10	B4	12	OUTL-	Left-Channel Bridge Amplifier Negative Output

# Low-Cost, Mono/Stereo, 1.4W Differential Audio Power Amplifiers

## Pin Description (continued)

PIN					NAME	FUNCTION
MAX9718		MAX9719				
TDFN/ μMAX	UCSP	TQFN	UCSP	TSSOP		
—	—	12	D4	14	OUTR+	Right-Channel Bridge Amplifier Positive Output
—	—	15	D2	1	OUTR-	Right-Channel Bridge Amplifier Negative Output
—	—	16	D1	2	INR-	Right-Channel Inverting Input
EP	—	EP	—	EP	EP	Exposed Pad. Connect EP to GND.

### Detailed Description

The MAX9718/MAX9719 are 1.4W BTL speaker amplifiers. The MAX9718 is a mono speaker amplifier, while the MAX9719 is a stereo speaker amplifier. Both devices feature a low-power shutdown mode, and industry-leading click-and-pop suppression. The MAX9718 features a two-input shutdown scheme to configure shutdown for active high or active low. These devices consist of high output-current audio amps configured as BTL amplifiers (see the *Functional Diagrams*). Both adjustable and fixed gain (0dB, 3dB, 6dB) versions are available.

### BIAS

These devices operate from a single 2.7V to 5.5V supply and feature an internally generated, common-mode bias voltage of  $V_{CC}/2$  referenced to ground. BIAS provides both click-and-pop suppression and sets the DC bias level for the audio outputs. Choose the value of the bypass capacitor as described in the *BIAS Capacitor* section. Do not connect external loads to BIAS as this can affect the overall performance.

### Shutdown Mode

The MAX9718/MAX9719 feature a 100nA low-power shutdown mode that reduces quiescent current consumption. Entering shutdown disables the device's bias circuitry, the amplifier outputs go high impedance, and BIAS is driven to GND. The MAX9718 SHDM input controls the polarity of SHDN. Drive SHDM high for an active-high SHDN input. Drive SHDM low for an active-low SHDN input (see Table 1). The MAX9719 features an active-low shutdown input,  $\overline{\text{SHDN}}$ .

### Click-and-Pop Suppression

The MAX9718/MAX9719 feature Maxim's industry-leading click-and-pop suppression circuitry. During startup, the amplifier common-mode bias voltage ramps to the DC bias point. When entering shutdown, the amplifier outputs are high impedance to 100kΩ between both outputs. This scheme minimizes the energy present in the audio band.

**Table 1. Shutdown Mode Selection (MAX9718 Only)**

SHDM	SHDN	OPERATIONAL MODE
0	0	Shutdown
0	1	Normal operation
1	0	Normal operation
1	1	Shutdown

## Applications Information

### BTL Amplifier

The MAX9718/MAX9719 are designed to drive a load differentially, a configuration referred to as bridge-tied load or BTL. The BTL configuration (Figure 1) offers advantages over the single-ended configuration, where one side of the load is connected to ground. Driving the load differentially doubles the output voltage compared to a single-ended amplifier under similar conditions.

Substituting  $2 \times V_{\text{OUT(P-P)}}$  for  $V_{\text{OUT(P-P)}}$  into the following equations yields four times the output power due to doubling of the output voltage:

$$V_{\text{RMS}} = \frac{V_{\text{OUT(P-P)}}}{2\sqrt{2}}$$

$$P_{\text{OUT}} = \frac{V_{\text{RMS}}^2}{R_L}$$

Since the differential outputs are biased at midsupply, there is no net DC voltage across the load. This eliminates the need for DC-blocking capacitors required for single-ended amplifiers. These capacitors can be large, expensive, consume board space, and degrade low-frequency performance.

# Low-Cost, Mono/Stereo, 1.4W Differential Audio Power Amplifiers

MAX9718/MAX9719

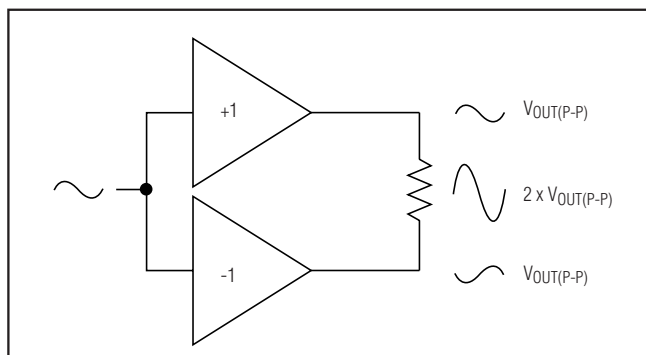

Figure 1. Bridge-Tied Load Configuration

## Power Dissipation and Heat Sinking

Under normal operating conditions, the MAX9718/MAX9719 dissipate a significant amount of power. The maximum power dissipation for each package is given in the *Absolute Maximum Ratings* section under Continuous Power Dissipation or can be calculated by the following equation:

$$P_{D(MAX)} = \frac{T_{J(MAX)} - T_A}{\theta_{JA}}$$

where  $T_{J(MAX)}$  is  $+150^{\circ}\text{C}$ ,  $T_A$  is the ambient temperature, and  $\theta_{JA}$  is the reciprocal of the derating factor in  $^{\circ}\text{C}/\text{W}$  as specified in the *Absolute Maximum Ratings* section. For example,  $\theta_{JA}$  of the TQFN package is  $+59.2^{\circ}\text{C}/\text{W}$ .

The increase in power delivered by the BTL configuration directly results in an increase in internal power dissipation over the single-ended configuration. The maximum internal power dissipation for a given  $V_{CC}$  and load is given by the following equation:

$$P_{D(MAX)} = \frac{2V_{CC}^2}{\pi^2 R_L}$$

If the internal power dissipation for a given application exceeds the maximum allowed for a given package, reduce power dissipation by increasing the ground plane heat-sinking capability and the size of the traces to the device (see the *Layout and Grounding* section). Other methods for reducing power dissipation are to reduce  $V_{CC}$ , increase load impedance, decrease ambient temperature, reduce gain, or reduce input signal.

Thermal-overload protection limits total power dissipation in the MAX9718/MAX9719. When the junction temperature exceeds  $+160^{\circ}\text{C}$ , the thermal protection circuitry disables the amplifier output stage. The amplifiers are enabled once the junction temperature cools

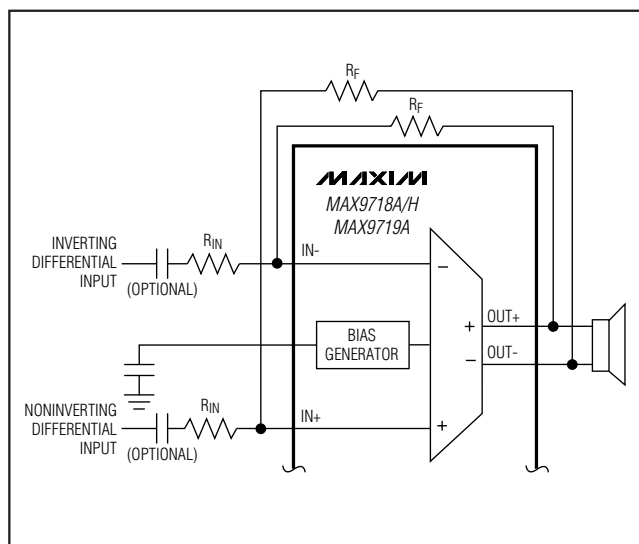

Figure 2. Setting the MAX9718A/H/MAX9719A Gain

by  $15^{\circ}\text{C}$ . A pulsing output under continuous thermal overload results as the device heats and cools.

For optimum power dissipation and heat sinking, connect the exposed pad found on the  $\mu\text{MAX}$ , TDFN, TQFN, and TSSOP packages to a large ground plane.

## Fixed Differential Gain

The MAX9718B/E, MAX9718C/F, MAX9718D/G, MAX9719B, MAX9719C, and MAX9719D feature internally fixed gains (see the *Selector Guide*). This simplifies design, decreases required footprint size, and eliminates external gain-setting resistors. Resistors  $R_1$  and  $R_2$  shown in the *Typical Operating Circuit* are used to achieve each fixed gain.

## Adjustable Differential Gain Gain-Setting Resistors

External feedback resistors set the gain of the MAX9718A/H and MAX9719A. Resistors  $R_F$  and  $R_{IN}$  (Figure 2) set the gain of the amplifier as follows:

$$A_V = \frac{R_F}{R_{IN}}$$

where  $A_V$  is the desired voltage gain. Hence, an  $R_{IN}$  of  $10\text{k}\Omega$  and an  $R_F$  of  $20\text{k}\Omega$  yields a gain of  $2\text{V}/\text{V}$ , or  $6\text{dB}$ .

$R_F$  can be either fixed or variable, allowing the use of a digitally controlled potentiometer to alter the gain under software control.

# Low-Cost, Mono/Stereo, 1.4W Differential Audio Power Amplifiers

## Input Filter

The fully differential amplifier inputs can be biased at voltages other than midsupply. The common-mode feedback circuit adjusts for input bias, ensuring the outputs are still biased at midsupply. Input capacitors are not required as long as the common-mode input voltage is within the specified range listed in the *Electrical Characteristics* table.

If input capacitors are used, input capacitor  $C_{IN}$ , in conjunction with  $R_{IN}$ , forms a highpass filter that removes the DC bias from an incoming signal. The AC-coupling capacitor allows the amplifier to bias the signal to an optimum DC level. Assuming zero-source impedance, the -3dB point of the highpass filter is given by:

$$f_{-3dB} = \frac{1}{2\pi R_{IN} C_{IN}}$$

Setting  $f_{-3dB}$  too high affects the low-frequency response of the amplifier. Use capacitors with dielectrics that have low-voltage coefficients, such as tantalum or aluminum electrolytic. Capacitors with high-voltage coefficients, such as ceramics, can increase distortion at low frequencies.

## BIAS Capacitor

BIAS is the output of the internally generated  $V_{CC}/2$  bias voltage. The BIAS bypass capacitor,  $C_{BIAS}$ , improves PSRR and THD+N by reducing power supply and other noise sources at the common-mode bias node, and also generates the clickless/popless startup DC bias waveform for the speaker amplifiers. Bypass BIAS with a 0.1 $\mu$ F capacitor to GND. Larger values of  $C_{BIAS}$  (up to 1 $\mu$ F) improve PSRR, but slow down  $t_{ON}/t_{OFF}$  times. A 1 $\mu$ F  $C_{BIAS}$  capacitor slows turn-on and turn-off times by 10 and improves PSRR by 20dB (at 1kHz). Do not connect external loads to BIAS.

## Supply Bypassing

Proper power-supply bypassing ensures low-noise, low-distortion performance. Connect a 1 $\mu$ F ceramic capacitor from  $V_{CC}$  to GND. Add additional bulk capacitance as required by the application. Locate the bypass capacitor as close to the device as possible.

## Layout and Grounding

Good PC board layout is essential for optimizing performance. Use large traces for the power-supply inputs and amplifier outputs to minimize losses due to parasitic trace resistance and route heat away from the device. Good grounding improves audio performance, minimizes crosstalk between channels, and prevents any digital switching noise from coupling into the audio signal.

The MAX9718/MAX9719 TDFN, TQFN, TSSOP, and  $\mu$ MAX packages feature exposed thermal pads on their undersides. This pad lowers the thermal resistance of the package by providing a direct-heat conduction path from the die to the PC board. Connect the exposed pad to the ground plane using multiple vias, if required.

## UCSP Applications Information

For the latest application details on UCSP construction, dimensions, tape carrier information, PC board techniques, bump-pad layout, and recommended reflow temperature profile, as well as the latest information on reliability testing results, refer to the Application Note: *UCSP—A Wafer-Level Chip-Scale Package* available on Maxim's website at [www.maxim-ic.com/ucsp](http://www.maxim-ic.com/ucsp).

## Selector Guide

PART	MONO	STEREO	GAIN (dB)	SELECTABLE SHUTDOWN POLARITY
MAX9718A/H	√	—	Adjustable	√
MAX9718B/E	√	—	0	√
MAX9718C/F	√	—	3	√
MAX9718D/G	√	—	6	√
MAX9719A	—	√	Adjustable	—
MAX9719B	—	√	0	—
MAX9719C	—	√	3	—
MAX9719D	—	√	6	—

# Low-Cost, Mono/Stereo, 1.4W Differential Audio Power Amplifiers

## Ordering Information (continued)

PART	TEMP RANGE	PIN-PACKAGE	TOP MARK
MAX9718AETB+T	-40°C to +85°C	10 TDFN-EP*	+AAV
MAX9718AEUB	-40°C to +85°C	10 μMAX-EP*	AAAA
MAX9718AEUB+	-40°C to +85°C	10 μMAX-EP*	+AAAA
MAX9718BEBL-T	-40°C to +85°C	3 x 3 UCSP	ADY
MAX9718BEBL+T	-40°C to +85°C	3 x 3 UCSP	+ADY
MAX9718BETB-T	-40°C to +85°C	10 TDFN-EP*	AAW
MAX9718BETB+T	-40°C to +85°C	10 TDFN-EP*	+AAW
MAX9718BEUB	-40°C to +85°C	10 μMAX-EP*	AAAB
MAX9718BEUB+	-40°C to +85°C	10 μMAX-EP*	+AAAB
MAX9718CEBL-T	-40°C to +85°C	3 x 3 UCSP	ADZ
MAX9718CEBL+T	-40°C to +85°C	3 x 3 UCSP	+ADZ
MAX9718CETB-T	-40°C to +85°C	10 TDFN-EP*	AAX
MAX9718CETB+T	-40°C to +85°C	10 TDFN-EP*	+AAX
MAX9718CEUB	-40°C to +85°C	10 μMAX-EP*	AAAC
MAX9718CEUB+	-40°C to +85°C	10 μMAX-EP*	+AAAC
MAX9718DEBL-T	-40°C to +85°C	3 x 3 UCSP	AEA
MAX9718DEBL+T	-40°C to +85°C	3 x 3 UCSP	+AEA
MAX9718DETB-T	-40°C to +85°C	10 TDFN-EP*	AAZ
MAX9718DETB+T	-40°C to +85°C	10 TDFN-EP*	+AAZ
MAX9718DEUB	-40°C to +85°C	10 μMAX-EP*	AAAD
MAX9718DEUB+	-40°C to +85°C	10 μMAX-EP*	+AAAD
MAX9718EEBL+T	-40°C to +85°C	3 x 3 UCSP	+AFB
MAX9718EETB+T	-40°C to +85°C	10 TDFN-EP*	+ASY
MAX9718EEUB+	-40°C to +85°C	10 μMAX-EP*	+AAAJ
MAX9718FEBL+T	-40°C to +85°C	3 x 3 UCSP	+AFC
MAX9718FETB+T	-40°C to +85°C	10 TDFN-EP*	+ASZ
MAX9718FEUB+	-40°C to +85°C	10 μMAX-EP*	+AAAK
MAX9718GEBL+T	-40°C to +85°C	3 x 3 UCSP	+AFD
MAX9718GETB+T	-40°C to +85°C	10 TDFN-EP*	+ATA
MAX9718GEUB+	-40°C to +85°C	10 μMAX-EP*	+AAAL
MAX9718HEBL+T	-40°C to +85°C	3 x 3 UCSP	+AFE
MAX9718HETB+T	-40°C to +85°C	10 TDFN-EP*	+ATB
MAX9718HEUB+	-40°C to +85°C	10 μMAX-EP*	+AAAM
<b>MAX9719AEBE-T</b>	-40°C to +85°C	4 x 4 UCSP	—
MAX9719AEBE+T	-40°C to +85°C	4 x 4 UCSP	—

PART	TEMP RANGE	PIN-PACKAGE	TOP MARK
MAX9719AETE	-40°C to +85°C	16 TQFN-EP*	—
MAX9719AETE+	-40°C to +85°C	16 TQFN-EP*	—
MAX9719AEUE	-40°C to +85°C	16 TSSOP-EP*	—
MAX9719AEUE+	-40°C to +85°C	16 TSSOP-EP*	—
MAX9719BEBE-T	-40°C to +85°C	4 x 4 UCSP	—
MAX9719BEBE+T	-40°C to +85°C	4 x 4 UCSP	—
MAX9719BETE	-40°C to +85°C	16 TQFN-EP*	—
MAX9719BETE+	-40°C to +85°C	16 TQFN-EP*	—
MAX9719BEUE	-40°C to +85°C	16 TSSOP-EP*	—
MAX9719BEUE+	-40°C to +85°C	16 TSSOP-EP*	—
MAX9719CEBE-T	-40°C to +85°C	4 x 4 UCSP	—
MAX9719CEBE+T	-40°C to +85°C	4 x 4 UCSP	—
MAX9719CETE	-40°C to +85°C	16 TQFN-EP*	—
MAX9719CETE+	-40°C to +85°C	16 TQFN-EP*	—
MAX9719CEUE	-40°C to +85°C	16 TSSOP-EP*	—
MAX9719CEUE+	-40°C to +85°C	16 TSSOP-EP*	—
MAX9719DEBE-T	-40°C to +85°C	4 x 4 UCSP	—
MAX9719DEBE+T	-40°C to +85°C	4 x 4 UCSP	—
MAX9719DETE	-40°C to +85°C	16 TQFN-EP*	—
MAX9719DETE+	-40°C to +85°C	16 TQFN-EP*	—
MAX9719DEUE	-40°C to +85°C	16 TSSOP-EP*	—
MAX9719DEUE+	-40°C to +85°C	16 TSSOP-EP*	—

+Denotes lead-free package.

\*EP = Exposed paddle.

### UCSP Marking Information:



■: A1 Bump indicator

AAA: Product code

XXX: Lot code

### Chip Information

MAX9718 TRANSISTOR COUNT: 2359

MAX9719 TRANSISTOR COUNT: 4447

PROCESS: BiCMOS

# Low-Cost, Mono/Stereo, 1.4W Differential Audio Power Amplifiers

## System Diagram

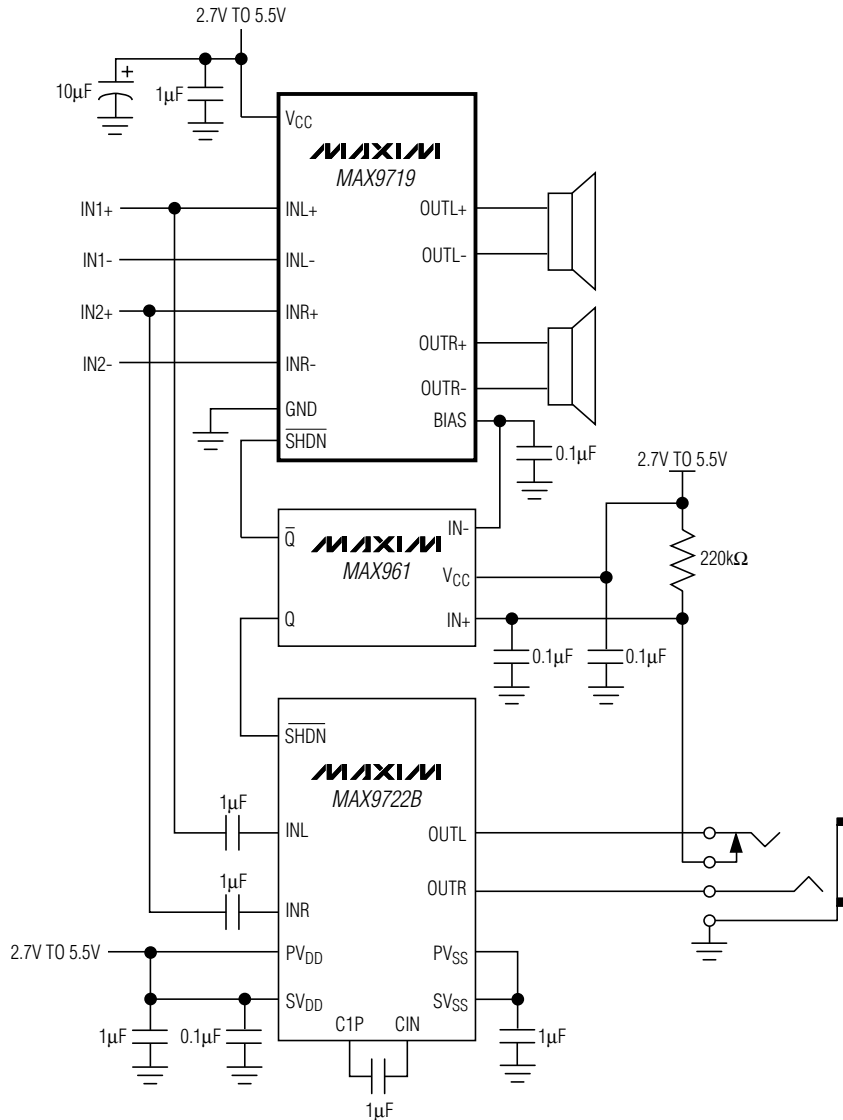

AUTOMATIC HEADPHONE DETECTION AND SPEAKER DISABLE CIRCUIT

# Low-Cost, Mono/Stereo, 1.4W Differential Audio Power Amplifiers

## Functional Diagrams

MAX9718/MAX9719

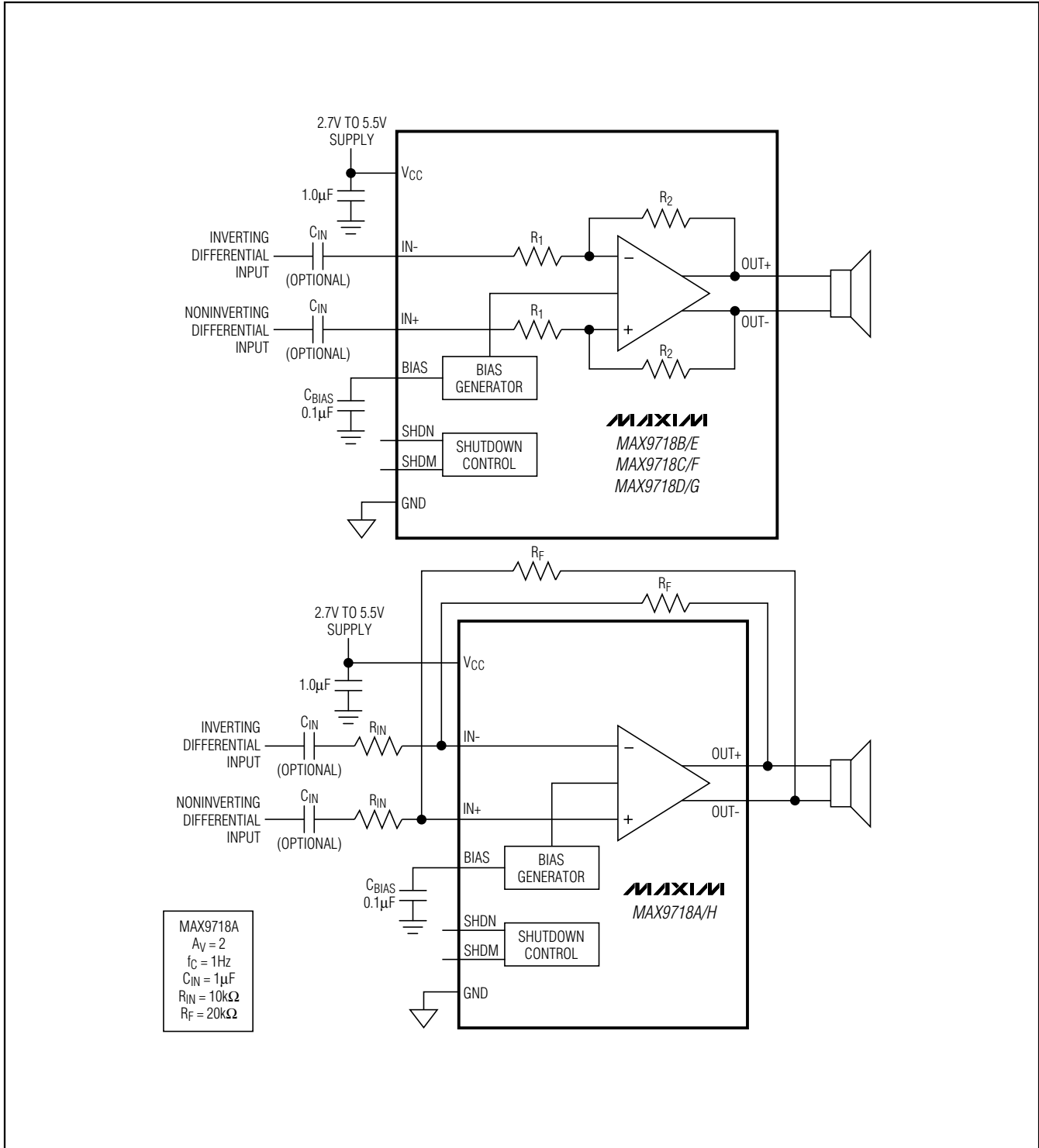

# Low-Cost, Mono/Stereo, 1.4W Differential Audio Power Amplifiers

## Functional Diagrams (continued)

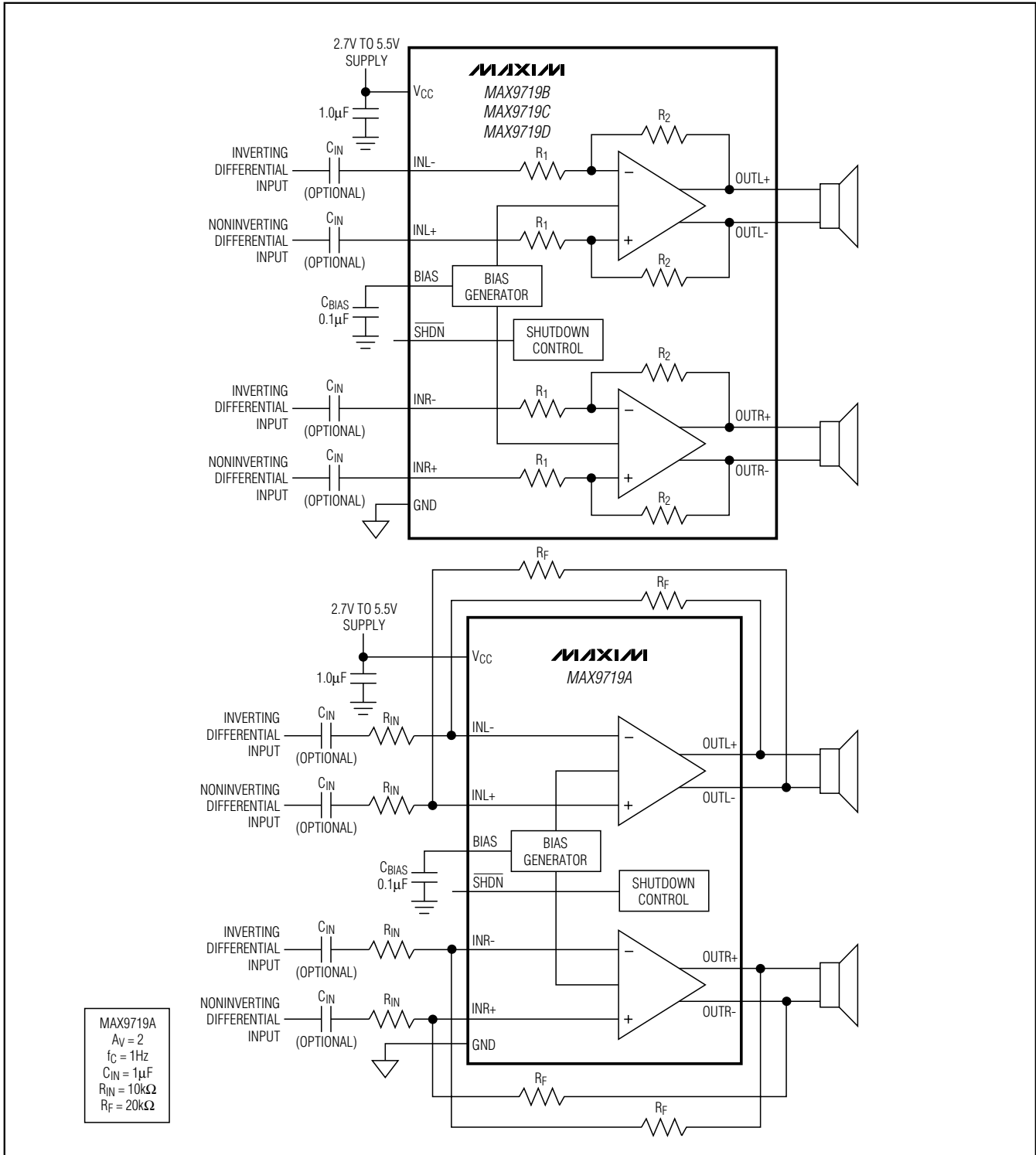



# Low-Cost, Mono/Stereo, 1.4W Differential Audio Power Amplifiers

## Pin Configurations

MAX9718/MAX9719

TOP VIEW

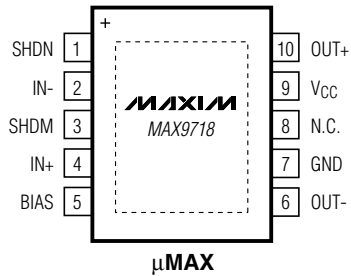

TOP VIEW  
(BUMPS ON BOTTOM)

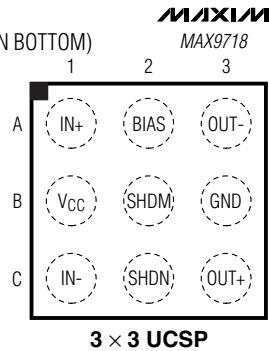

TOP VIEW

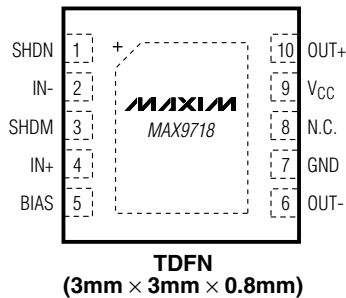

TOP VIEW  
(BUMPS ON BOTTOM)

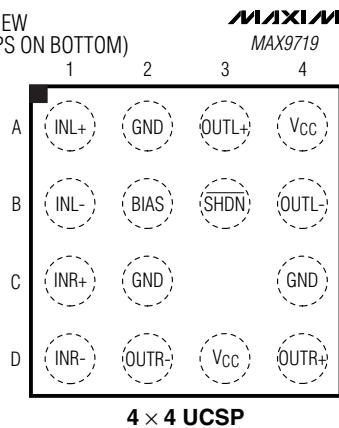

TOP VIEW

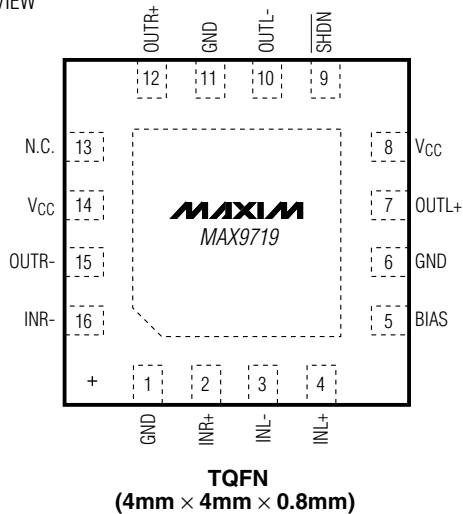

TOP VIEW

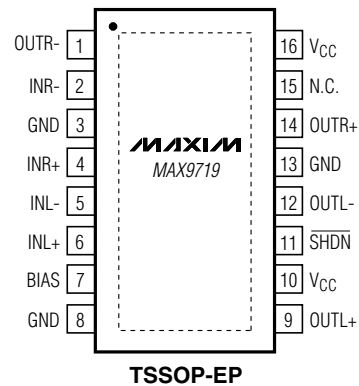

# Low-Cost, Mono/Stereo, 1.4W Differential Audio Power Amplifiers

## Package Information

(The package drawing(s) in this data sheet may not reflect the most current specifications. For the latest package outline information go to [www.maxim-ic.com/packages](http://www.maxim-ic.com/packages).)

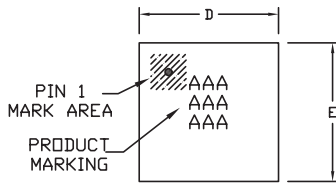

TOP VIEW

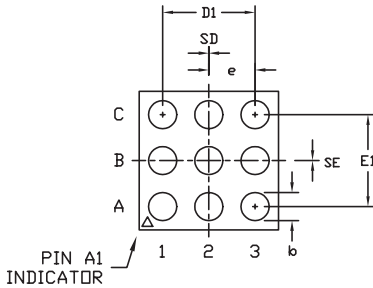

BOTTOM VIEW

COMMON DIMENSIONS	
A	0.62±0.05-0.08
A1	0.29±0.02
A2	0.33 REF.
b	∅0.35±0.03
D1	1.00 BASIC
E1	1.00 BASIC
e	0.50 BASIC
SD	0.00 BASIC
SE	0.00 BASIC

PKG. CODE	VARIABLE DIMENSIONS		DEPOPULATED SOLDER BALLS
	D	E	
B9-1	1.52±0.05	1.52±0.05	NONE
B9-2	1.52±0.05	1.52±0.05	B2
B9-3	1.52±0.05	1.52±0.05	B1, B2, B3
B9-4	1.60±0.05	1.60±0.05	NONE
B9-5	1.60±0.05	1.60±0.05	B2
B9-6	1.60±0.05	1.60±0.05	B1, B2, B3
B9-7	1.52±0.05	1.52±0.05	A2, B1, B2, B3, C2
B9-8	1.98±0.05	1.75±0.05	B1, B2, B3

NOTES:

1. ALL DIMENSIONS ARE IN MILLIMETERS.
2. PRODUCT MARKING: NUMBER OF CHARACTERS AND LINES VARY PER PRODUCT.

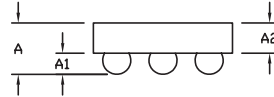

SIDE VIEW

-DRAWING NOT TO SCALE-

TITLE: PACKAGE OUTLINE, 3x3 UCSP		
APPROVAL:	DOCUMENT CONTROL NO. 21-0093	REV. L 1/1

9LUCSP, 3x3.EPS

# Low-Cost, Mono/Stereo, 1.4W Differential Audio Power Amplifiers

## Package Information (continued)

(The package drawing(s) in this data sheet may not reflect the most current specifications. For the latest package outline information go to [www.maxim-ic.com/packages](http://www.maxim-ic.com/packages).)

MAX9718/MAX9719

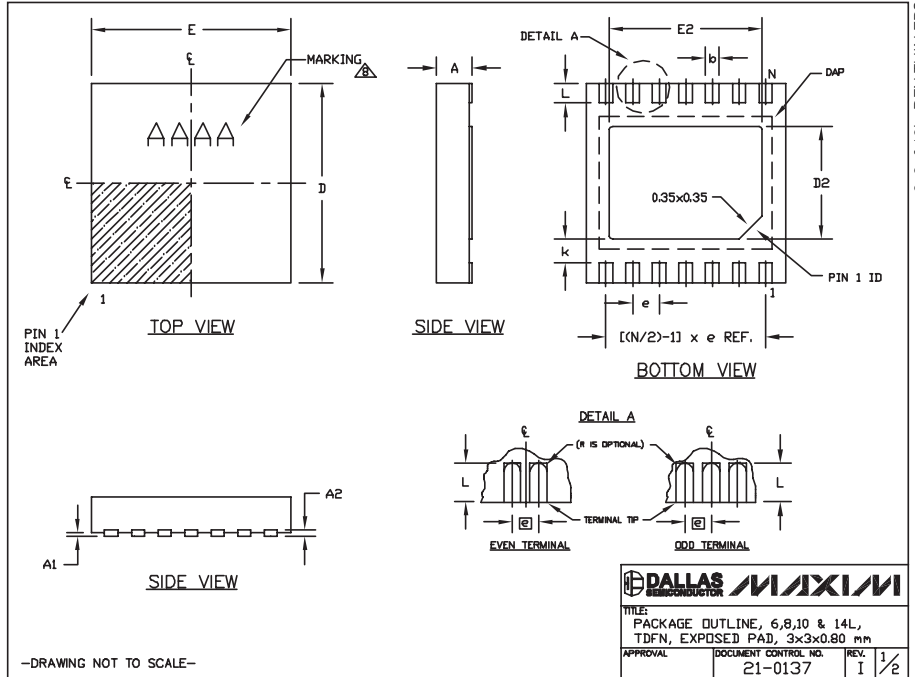

COMMON DIMENSIONS			PACKAGE VARIATIONS							
SYMBOL	MIN.	MAX.	PKG. CODE	N	D2	E2	e	JEDEC SPEC	b	[(N/2)-1] x e
A	0.70	0.80	T633-2	6	1.50±0.10	2.30±0.10	0.95 BSC	MO229 / WEEA	0.40±0.05	1.90 REF
D	2.90	3.10	T833-2	8	1.50±0.10	2.30±0.10	0.65 BSC	MO229 / WEEC	0.30±0.05	1.95 REF
E	2.90	3.10	T833-3	8	1.50±0.10	2.30±0.10	0.65 BSC	MO229 / WEEC	0.30±0.05	1.95 REF
A1	0.00	0.05	T1033-1	10	1.50±0.10	2.30±0.10	0.50 BSC	MO229 / WEED-3	0.25±0.05	2.00 REF
L	0.20	0.40	T1033-2	10	1.50±0.10	2.30±0.10	0.50 BSC	MO229 / WEED-3	0.25±0.05	2.00 REF
k	0.25 MIN.		T1433-1	14	1.70±0.10	2.30±0.10	0.40 BSC	----	0.20±0.05	2.40 REF
A2	0.20 REF.		T1433-2	14	1.70±0.10	2.30±0.10	0.40 BSC	----	0.20±0.05	2.40 REF

NOTES:  
 1. ALL DIMENSIONS ARE IN mm. ANGLES IN DEGREES.  
 2. COPLANARITY SHALL NOT EXCEED 0.08 mm.  
 3. WARPAGE SHALL NOT EXCEED 0.10 mm.  
 4. PACKAGE LENGTH/PACKAGE WIDTH ARE CONSIDERED AS SPECIAL CHARACTERISTIC(S).  
 5. DRAWING CONFORMS TO JEDEC MO229, EXCEPT DIMENSIONS "D2" AND "E2", AND T1433-1 & T1433-2.  
 6. "N" IS THE TOTAL NUMBER OF LEADS.  
 7. NUMBER OF LEADS SHOWN ARE FOR REFERENCE ONLY.  
 MARKING IS FOR PACKAGE ORIENTATION REFERENCE ONLY.

-DRAWING NOT TO SCALE-

APPROVAL	DOCUMENT CONTROL NO.	REV.	2/2
	21-0137	I	

# Low-Cost, Mono/Stereo, 1.4W Differential Audio Power Amplifiers

## Package Information (continued)

(The package drawing(s) in this data sheet may not reflect the most current specifications. For the latest package outline information go to [www.maxim-ic.com/packages](http://www.maxim-ic.com/packages).)

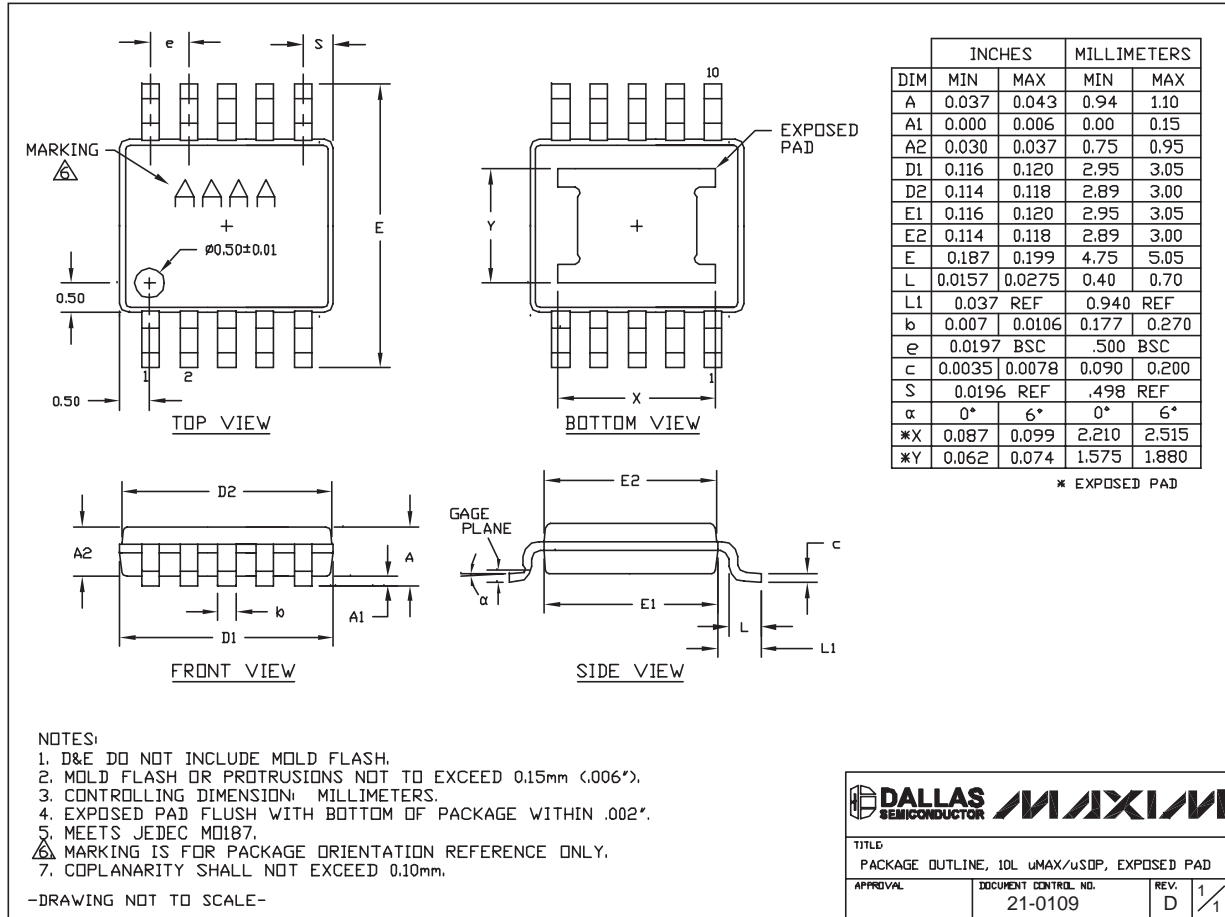

10L UMAX, EXPPADS.EPS

# Low-Cost, Mono/Stereo, 1.4W Differential Audio Power Amplifiers

## Package Information (continued)

(The package drawing(s) in this data sheet may not reflect the most current specifications. For the latest package outline information go to [www.maxim-ic.com/packages](http://www.maxim-ic.com/packages).)

MAX9718/MAX9719

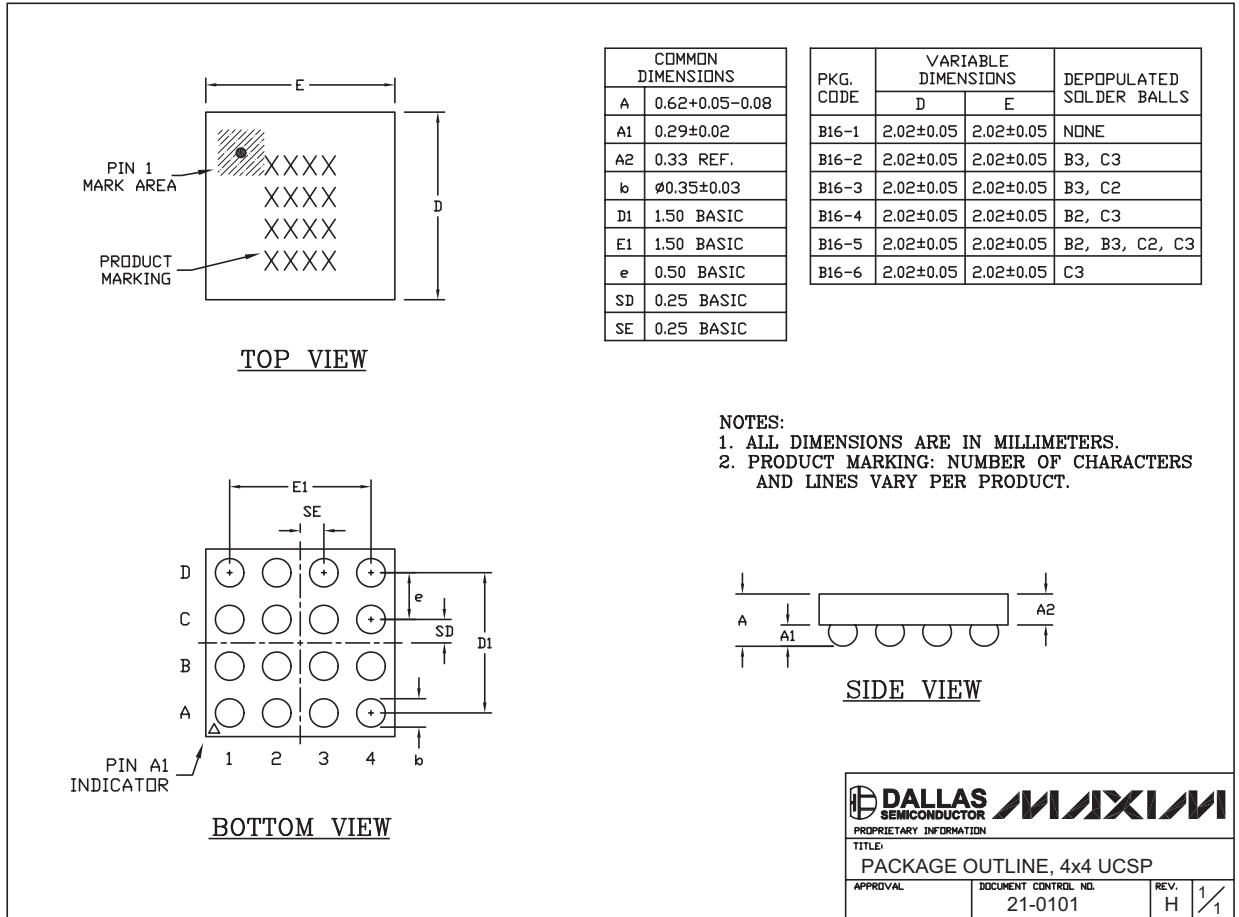

161UCSP.EPS

# Low-Cost, Mono/Stereo, 1.4W Differential Audio Power Amplifiers

## Package Information (continued)

(The package drawing(s) in this data sheet may not reflect the most current specifications. For the latest package outline information go to [www.maxim-ic.com/packages](http://www.maxim-ic.com/packages).)

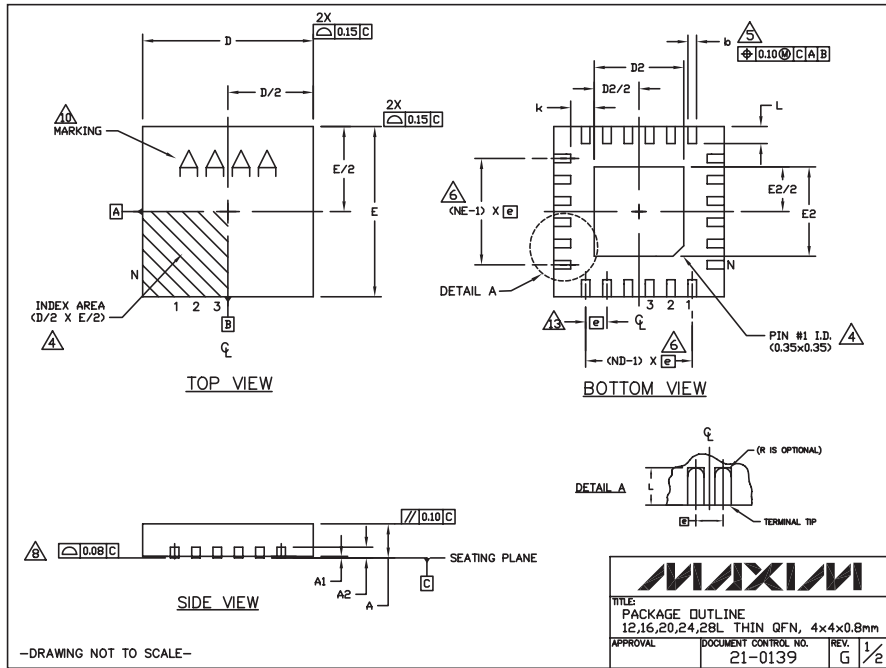

COMMON DIMENSIONS															
PKG	12L 4x4			16L 4x4			20L 4x4			24L 4x4			28L 4x4		
REF.	MIN.	NDM.	MAX.	MIN.	NDM.	MAX.	MIN.	NDM.	MAX.	MIN.	NDM.	MAX.	MIN.	NDM.	MAX.
A	0.70	0.75	0.80	0.70	0.75	0.80	0.70	0.75	0.80	0.70	0.75	0.80	0.70	0.75	0.80
A1	0.0	0.02	0.05	0.0	0.02	0.05	0.0	0.02	0.05	0.0	0.02	0.05	0.0	0.02	0.05
A2	0.20 REF.			0.20 REF.			0.20 REF.			0.20 REF.			0.20 REF.		
b	0.25	0.30	0.35	0.25	0.30	0.35	0.20	0.25	0.30	0.18	0.23	0.30	0.15	0.20	0.25
D	3.90	4.00	4.10	3.90	4.00	4.10	3.90	4.00	4.10	3.90	4.00	4.10	3.90	4.00	4.10
E	3.90	4.00	4.10	3.90	4.00	4.10	3.90	4.00	4.10	3.90	4.00	4.10	3.90	4.00	4.10
e	0.80 BSC.			0.65 BSC.			0.50 BSC.			0.50 BSC.			0.40 BSC.		
k	0.25	-	-	0.25	-	-	0.25	-	-	0.25	-	-	0.25	-	-
L	0.45	0.55	0.65	0.45	0.55	0.65	0.45	0.55	0.65	0.30	0.40	0.50	0.30	0.40	0.50
N	12			16			20			24			28		
ND	3			4			5			6			7		
NE	3			4			5			6			7		
UPDEC Vpr	WGGB			WGGC			WGGD-1			WGGD-2			WGGE		

EXPOSED PAD VARIATIONS						
PKG. CODES	DE			E2		
	MIN.	NDM.	MAX.	MIN.	NDM.	MAX.
T1244-3	1.95	2.10	2.25	1.95	2.10	2.25
T1244-4	1.95	2.10	2.25	1.95	2.10	2.25
T1644-3	1.95	2.10	2.25	1.95	2.10	2.25
T1644-4	1.95	2.10	2.25	1.95	2.10	2.25
T2044-2	1.95	2.10	2.25	1.95	2.10	2.25
T2044-3	1.95	2.10	2.25	1.95	2.10	2.25
T2444-2	1.95	2.10	2.25	1.95	2.10	2.25
T2444-3	2.45	2.60	2.63	2.45	2.60	2.63
T2444-4	2.45	2.60	2.63	2.45	2.60	2.63
T2844-1	2.50	2.60	2.70	2.50	2.60	2.70

NOTES:

- DIMENSIONING & TOLERANCING CONFORM TO ASME Y14.5M-1994.
- ALL DIMENSIONS ARE IN MILLIMETERS. ANGLES ARE IN DEGREES.
- N IS THE TOTAL NUMBER OF TERMINALS.
- THE TERMINAL #1 IDENTIFIER AND TERMINAL NUMBERING CONVENTION SHALL CONFORM TO JEDEC 95-1 SPP-012. DETAILS OF TERMINAL #1 IDENTIFIER ARE OPTIONAL, BUT MUST BE LOCATED WITHIN THE ZONE INDICATED. THE TERMINAL #1 IDENTIFIER MAY BE EITHER A MOLD OR MARKED FEATURE.
- DIMENSION b APPLIES TO METALLIZED TERMINAL AND IS MEASURED BETWEEN 0.25mm AND 0.30mm FROM TERMINAL TIP.
- ND AND NE REFER TO THE NUMBER OF TERMINALS ON EACH D AND E SIDE RESPECTIVELY.
- DEPOPULATION IS POSSIBLE IN A SYMMETRICAL FASHION.
- COPLANARITY APPLIES TO THE EXPOSED HEAT SINK SLUG AS WELL AS THE TERMINALS.
- DRAWING CONFORMS TO JEDEC MD20, EXCEPT FOR T2444-3, T2444-4 AND T2844-1.
- MARKING IS FOR PACKAGE ORIENTATION REFERENCE ONLY.
- COPLANARITY SHALL NOT EXCEED 0.08mm.
- WARPAGE SHALL NOT EXCEED 0.10mm.
- LEAD CENTERLINES TO BE AT TRUE POSITION AS DEFINED BY BASIC DIMENSION 'e', ±0.05.
- NUMBER OF LEADS SHOWN ARE FOR REFERENCE ONLY.
- ALL DIMENSIONS ARE THE SAME FOR LEADED (←) & PBFREE (→) PACKAGE CODES.

MAXIM

TITLE: PACKAGE OUTLINE  
12,16,20,24,28L THIN QFN, 4x4x0.8mm

APPROVAL DOCUMENT CONTROL NO. REV. 21-0139 G 2/2

-DRAWING NOT TO SCALE-

# Low-Cost, Mono/Stereo, 1.4W Differential Audio Power Amplifiers

## Package Information (continued)

(The package drawing(s) in this data sheet may not reflect the most current specifications. For the latest package outline information go to [www.maxim-ic.com/packages](http://www.maxim-ic.com/packages).)

MAX9718/MAX9719

TSSOP 4.4mm BODY, EPS

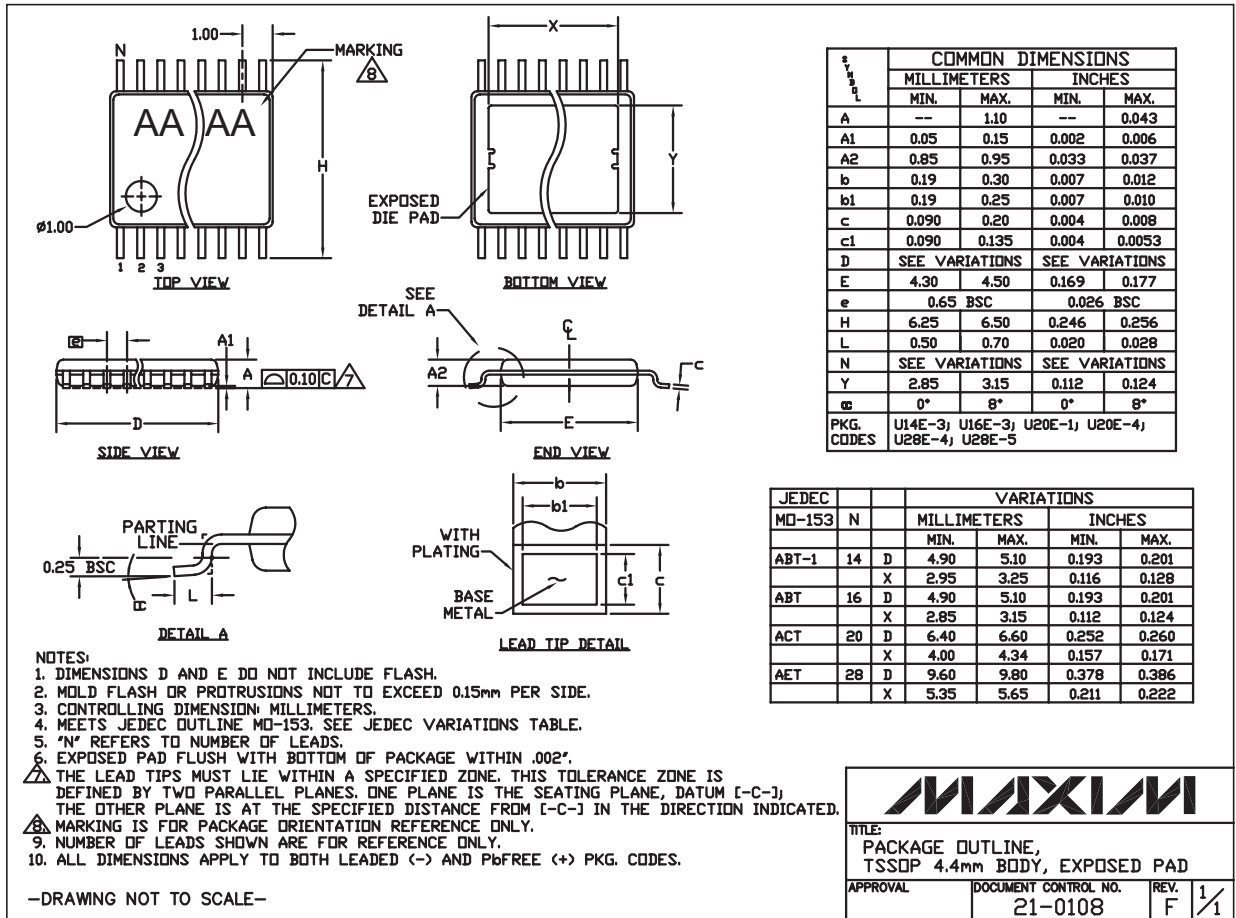

# Low-Cost, Mono/Stereo, 1.4W Differential Audio Power Amplifiers

## Revision History

REVISION NUMBER	REVISION DATE	DESCRIPTION	PAGES CHANGED
0	10/03	Initial release	—
1	6/04	Updated <i>Ordering Information</i> .	1, 6, 7, 10, 11, 13–15
2	8/05	Added lead-free information to data sheet.	1, 13
3	8/06	Updated <i>Electrical Characteristics</i> and <i>Ordering Information</i> .	1–4, 13
4	9/06	Updated <i>Electrical Characteristics</i> , <i>Selector Guide</i> , and <i>Ordering Information</i> .	1–4, 11, 12, 13, 15, 16
5	2/08	Updated <i>Pin Configurations</i> .	17

Maxim cannot assume responsibility for use of any circuitry other than circuitry entirely embodied in a Maxim product. No circuit patent licenses are implied. Maxim reserves the right to change the circuitry and specifications without notice at any time.

24 \_\_\_\_\_ **Maxim Integrated Products, 120 San Gabriel Drive, Sunnyvale, CA 94086 408-737-7600**