

SPS-93120-CXX0G

(RoHS Compliant)

3.3V / CWDM / 2.5 Gb/s SFP LC SINGLE-MODE TRANSCEIVER

FEATURES

- | Hot-Pluggable SFP Footprint LC Optical Transceiver
- | Small Form-Factor Pluggable (SFP) MSA compatible
- | Up to 2.67 Gb/s bi-directional data links
- | Compliant with SONET OC-48 LR / SDH STM-16
- | Compliant with Fibre Channel 1X/2X SM-LC-L FC-PI
- | Compliant with IEEE 802.3z 1000BASE
- | **18 Wavelength (λ): 1270 nm to 1610 nm CWDM DFB LD Transmitter**
- | Multi-rate Operation for 2.488/2.125/1.25/1.063 Gb/s
- | APD High Sensitivity Receiver
- | 33 dB Power Budget at Least
- | AC/AC Coupling according to MSA
- | Single +3.3 V Power Supply
- | RoHS Compliant
- | 0 to 70°C Operation
- | Class 1 Laser International Safety Standard IEC-60825 Compliant

DESCRIPTION

The SPS-93120-CXX0G series single mode transceivers is small form factor pluggable module for bi-directional serial optical data communications such as SONET OC-48 / SDH STM-16, Gigabit Ethernet 1000BASE and Fibre Channel 1X/2X SM-LC-L FC-PI. It is with the SFP 20-pin connector to allow hot plug capability. This module is designed for single mode fiber and operates at a nominal wavelength of CWDM wavelength. There are eighteen center wavelengths available from 1270 nm to 1610 nm, with each step 20 nm. A guaranteed minimum optical link budget of 33 dB is offered. The transmitter section uses a multiple quantum well CWDM DFB laser and is a class 1 laser compliant according to International Safety Standard IEC-60825. The receiver section uses an integrated InGaAs detector preamplifier (IDP) mounted in an optical header and a limiting post-amplifier IC.

APPLICATIONS

- | SONET OC-48 SR / SDH STM-16 I-16
- | SONET OC-12 / SDH STM-4
- | SONET OC-3 / SDH STM-1
- | Gigabit Ethernet / 1X/2X Fibre Channel

LASER SAFETY

This single mode transceiver is a Class 1 laser product. It complies with IEC-60825 and FDA 21 CFR 1040.10 and 1040.11. The transceiver must be operated within the specified temperature and voltage limits. The optical ports of the module shall be terminated with an optical connector or with a dust plug.

ORDER INFORMATION

P/No.	Bit Rate (Gb/s)	SONET /SDH	Power Budget (dB)	Wavelength (nm)	Package	Temp. (°C)	TX Power (dBm)	RX Sens. (dBm)	RoHS Compliant
SPS-93120-CXX0G	2.488	LR-2/L-16.2	> 33	CWDM*	LC SFP	0 to 70	6 to 3	-30	Yes

CWDM* Wavelength (0 to 70°C)

Central Wavelength	Min. (nm)	Typ. (nm)	Max. (nm)	Clasp Color Code	Central Wavelength	Min. (nm)	Typ. (nm)	Max. (nm)	Clasp Color Code
-C270	1264.5	1270	1277.5	Light Purple	-C450	1444.5	1450	1457.5	Yellow Orange
-C290	1284.5	1290	1297.5	Sky Blue	-C470	1464.5	1470	1477.5	Gray
-C310	1304.5	1310	1317.5	Yellow Green	-C490	1484.5	1490	1497.5	Violet
-C330	1324.5	1330	1337.5	Yellow Ocher	-C510	1504.5	1510	1517.5	Blue
-C350	1344.5	1350	1357.5	Pink	-C530	1524.5	1530	1537.5	Green
-C370	1364.5	1370	1377.5	Beige	-C550	1544.5	1550	1557.5	Yellow
-C390	1384.5	1390	1397.5	White	-C570	1564.5	1570	1577.5	Orange
-C410	1404.5	1410	1417.5	Silver	-C590	1584.5	1590	1597.5	Red
-C430	1424.5	1430	1437.5	Black	-C610	1604.5	1610	1617.5	Brown

CWDM*: 18 Wavelengths from 1270 nm to 1610 nm, each step 20 nm.

Absolute Maximum Ratings						
Parameter	Symbol	Min	Max	Units	Notes	
Storage Temperature	T _{stg}	-40	85	°C		
Operating Case Temperature	T _{opr}	0	70	°C	Air flow 1m/sec	
Power Supply Voltage	V _{cc}	-0.5	3.6	V		

Recommended Operating Conditions						
Parameter	Symbol	Min	Typ	Max	Units / Notes	
Power Supply Voltage	V _{cc}	3.13	3.3	3.47	V	
Operating Case Temperature	T _{opr}	0		70	°C / Air flow 1m/sec	
Power Supply Current	I _{CC(TX+RX)}		230	300	mA	
Data Rate		622	2488	2670	Mb/s	

Transmitter Specifications (0°C < T _{opr} < 70°C, 3.13V < V _{cc} < 3.47V)						
Parameter	Symbol	Min	Typ	Max	Units	Notes
Optical						
Optical Transmit Power	P _o	3	---	6	dBm	1
Output Center Wavelength	λ	λ _c -5.5	λ _c	λ _c +7.5	nm	2
Output Spectrum Width	Δλ	---	---	1	nm	-20 dB Width
Side Mode Suppression Ratio	SMSR	30			dB	
Extinction Ratio	E _R	8.2	---	---	dB	
Output Eye	Compliant with Telecordia GR-253-GORE and ITU-T Recommendation G.957					
Optical Rise Time	t _r			150	ps	20 % to 80% Values
Optical Fall Time	t _f			150	ps	20 % to 80% Values
Relative Intensity Noise	RIN			-120	dB/Hz	
Dispersion Penalty				2.5	dB	3
Electrical						
Data Input Current – Low	I _{IL}	-350			μA	
Data Input Current – High	I _{IH}			350	μA	
Differential Input Voltage	V _{IH} - V _{IL}	0.5		2.4	V	Peak-to-Peak
TX Disable Input Voltage – Low	T _{DIS, L}	0		0.5	V	4
TX Disable Input Voltage – High	T _{DIS, H}	2.0		V _{cc}	V	4
TX Disable Assert Time	T _{ASSERT}			10	μs	
TX Disable Deassert Time	T _{DEASSERT}			1	ms	
TX Fault Output Voltage -- Low	T _{FAULTL}	0		0.5	V	5
TX Fault Output Voltage -- High	T _{FAULTH}	2.0		V _{cc} +0.3	V	5

1. Output power is power coupled into a 9/125 μm single mode fiber.
2. ITU-T G.694.2 CWDM wavelength from 1270 nm to 1610 nm, each step 20 nm.
3. Specified at 2000 ps/nm dispersion over G.652/G.654 fiber with center wavelength range of 1264.5 to 1617.5 nm.
4. There is an internal 4.7K to 10K ohm pull-up resistor to V_{cc}TX.
5. Open collector compatible, 4.7K to 10K ohm pull-up to V_{cc} (Host Supply Voltage).

Receiver Specifications (0°C < T _{opr} < 70°C, 3.13V < V _{cc} < 3.47V)						
Parameter	Symbol	Min	Typ	Max	Units	Notes
Optical						
Sensitivity	Sens			-30	dBm	6,7
Maximum Input Power	P _{in}	-9			dBm	6,7
Signal Detect -- Asserted	P _a	---		-30	dBm	Transition: low to high
Signal Detect -- Deasserted	P _d	-40	---	---	dBm	Transition: high to low
Signal detect – Hysteresis		1.0	---		dB	
Wavelength of Operation		1260	---	1620	nm	
Electrical						

Differential Output Voltage	$V_{OH} - V_{OL}$	0.6		2.0	V	
Output LOS Voltage -- Low	V_{OL}	0		0.5	V	8
Output LOS Voltage -- High	V_{OH}	2.0		$V_{CC}+0.3$	V	8

6. Measured at $2^{23}-1$ PRBS at BER $1E-10$.
7. Measured at 2^7-1 PRBS at BER $1E-12$ for 2.125 Gb/s, 1.25Gb/s, and 1.063 Gb/s.
8. Open collector compatible, 4.7K to 10K ohm pull-up to V_{CC} (Host Supply Voltage).

CONNECTION DIAGRAM

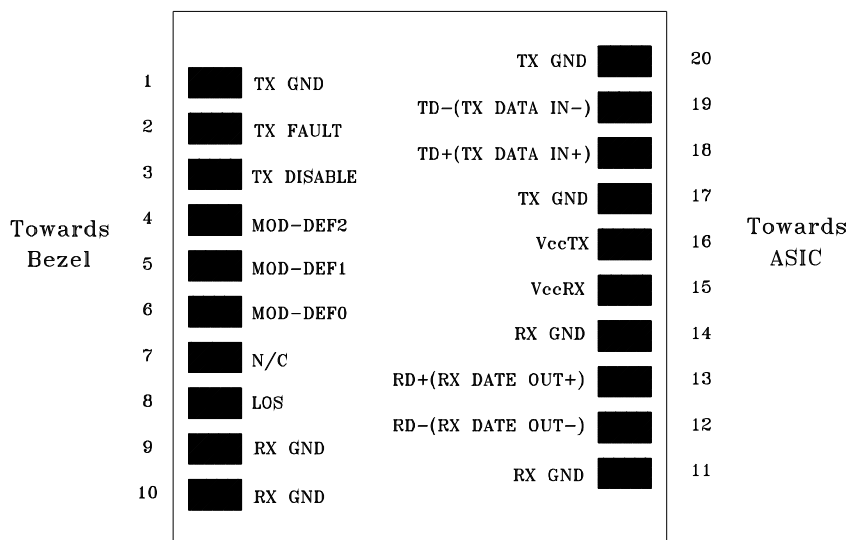

PIN	Signal Name	Description	PIN	Signal Name	Description
1	TX GND	Transmitter Ground	11	RX GND	Receiver Ground
2	TX Fault	Transmitter Fault Indication	12	RX DATA OUT-	Inverse Receiver Data Out
3	TX Disable	Transmitter Disable (Module disables on high or open)	13	RX DATA OUT+	Receiver Data Out
4	MOD-DFE2	Modulation Definition 2 – Two wires serial ID Interface	14	RX GND	Receiver Ground
5	MOD-DEF1	Modulation Definition 1 – Two wires serial ID Interface	15	Vcc RX	Receiver Power – 3.3V±5%
6	MOD-DEF0	Modulation Definition 0 – Ground in Module	16	Vcc TX	Transmitter Power – 3.3V±5%
7	N/C	Not Connected	17	TX GND	Transmitter Ground
8	LOS	Loss of Signal	18	TX DATA IN+	Transmitter Data In
9	RX GND	Receiver Ground	19	TX DATA IN-	Inverse Transmitter Data In
10	RX GND	Receiver Ground	20	TX GND	Transmitter Ground

Module Definition

Module Definition	MOD-DEF2 PIN 4	MOD-DEF1 PIN 5	MOD-DEF0 PIN 6	Interpretation by Host
4	SDA	SCL	LV-TTL Low	Serial module definition protocol

Module Definition 4 specifies a serial definition protocol. For this definition, upon power up, MOD-DEF(1:2) appear as no connector (NC) and MOD-DEF(0) is TTL LOW. When the host system detects this condition, it activates the serial protocol. The protocol uses the 2-wire serial CMOS E²PROM protocol of the ATMEL AT24C01A/02/04 family of components.

RECOMMENDED CIRCUIT SCHEMATIC

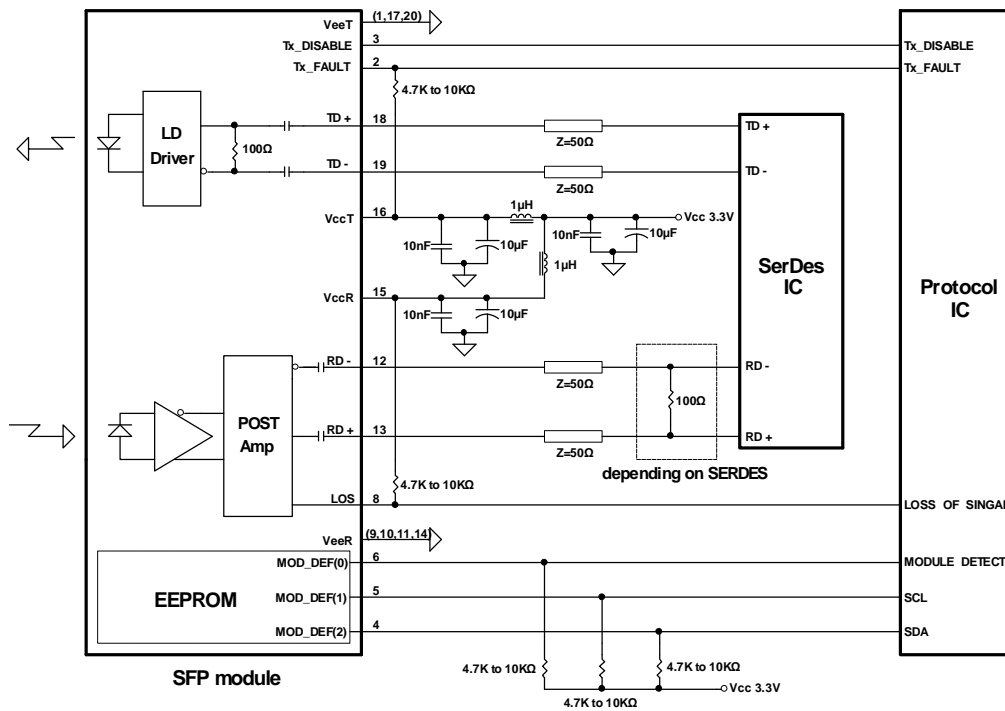

PACKAGE DIAGRAM

Units in mm



Note: Specifications subject to change without notice.

Revision History

Version	Subject	Release Date
1.0	Initial datasheet	2004/1/1
2.0	Add 1270 to 1450 nm CWDM.	2005/12/1
3.0	1. Revise package diagram for high port density use 2. Add clasp color codes for 18 wavelengths	2008/1/1