

Rectifier Diode SXXHN/HR6

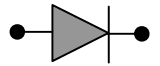

Symbol	Characteristics	Conditions	T _J (°C)	Value	Unit
BLOCKING PARAMETERS					
V _{RRM}	Repetitive peak reverse voltage		180	200-1500	V
I _{RRM}	Repetitive peak reverse current	V = V _{RRM}	180	2	mA
CONDUCTING PARAMETERS					
I _{F(AV)}	Average on-state current	180 sine, 50Hz, T _C = 130°C		6	A
I _{RMS}	RMS on-state current			9.5	A
I _{FSM}	Non repetitive peak surge on-state current	Sine wave, 10mS without reverse voltage	180	200	A
I ² t	Permissible surge energy			200	A ² S
V _{FM}	Peak on-state voltage drop	On-state current = 20A	180	1.30	V
V ₀	Typical forward conduction Threshold voltage		180	0.70	V
r ₀	Typical forward slope resistance		180	16.50	mΩ
THERMAL & MECHANICAL PARAMETERS					
R _{TH(J-C)}	Thermal impedance, 180° conduction, Sine	Junction to case		4.50	°C/W
R _{TH(C-HK)}	Thermal impedance	Case to heatsink		0.60	°C/W
T _J	Maximum Permissible junction temperature			180	°C
T _{STG}	Storage temperature range			-40 – 180	°C
F	Mounting Torque			2	NM
W	Weight			10	gms



HIND RECTIFIERS LTD

Rectifier Diode SXXHN/HR6

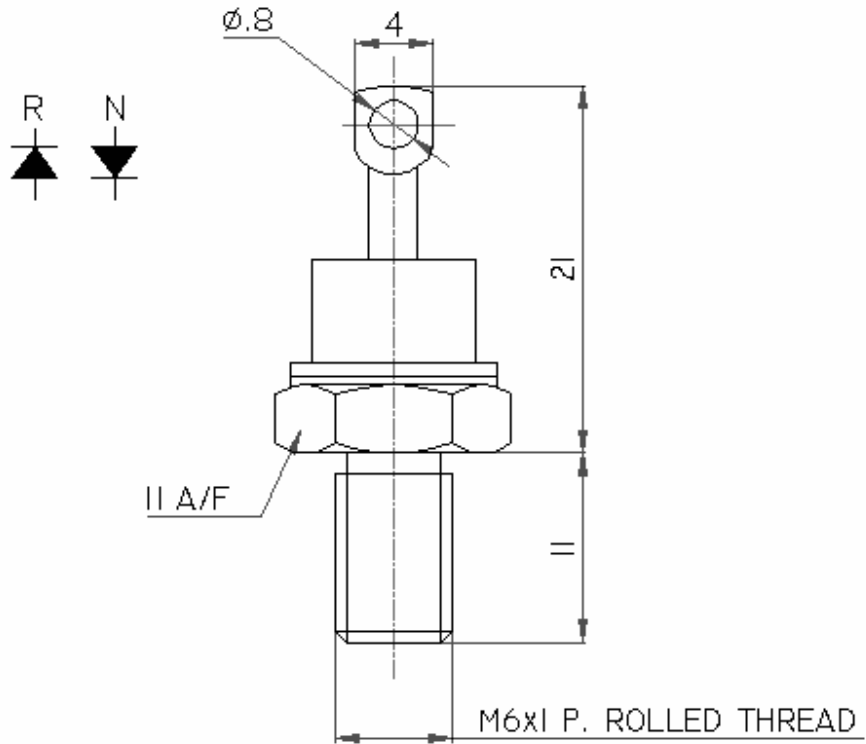
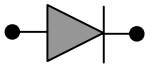

ALL DIMENSIONS IN MM

On State Power Loss

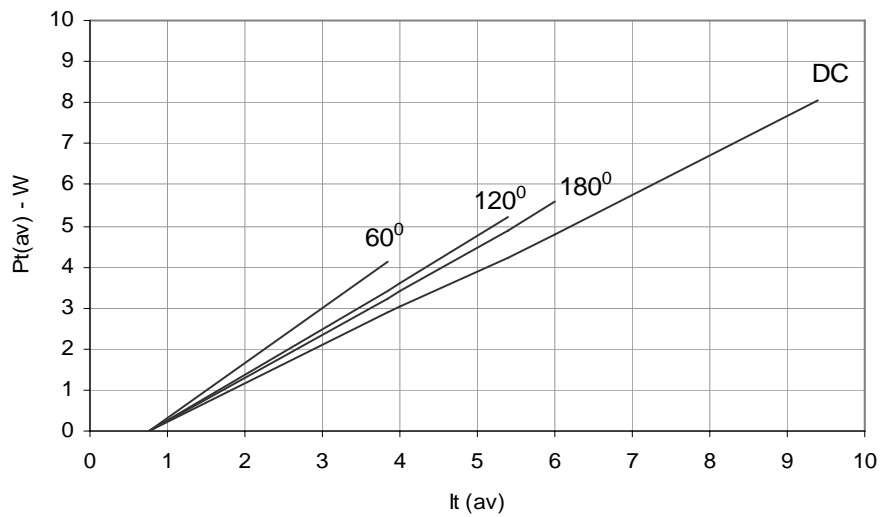

HIND RECTIFIERS LTD

Rectifier Diode SXXHN/HR6

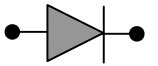

Maximum Permissible Case Temp

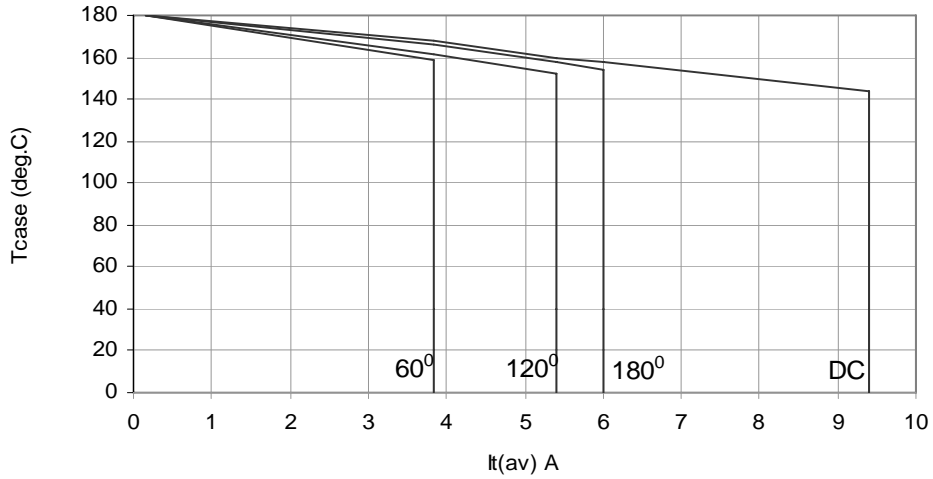

Max non repetitive Surge Current

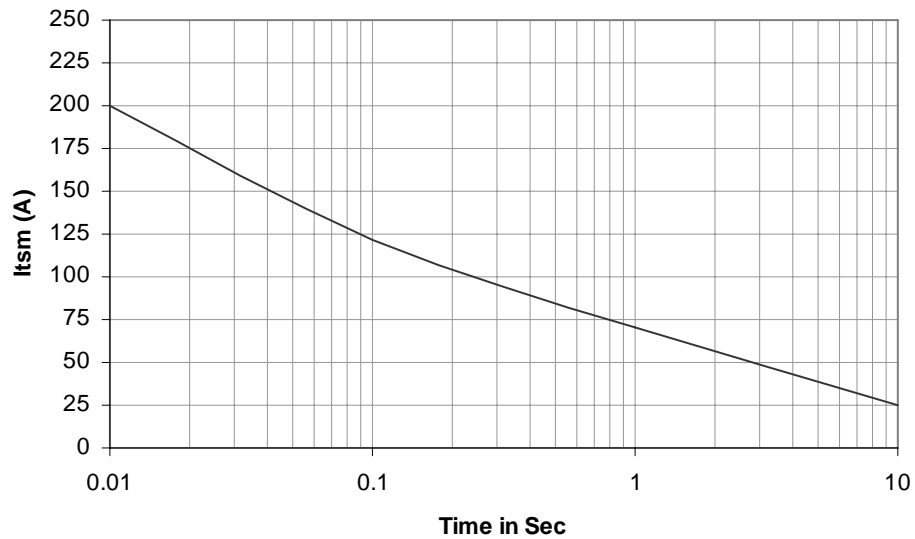

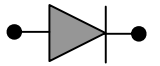

Transient Thermal Impedance Junction to Case

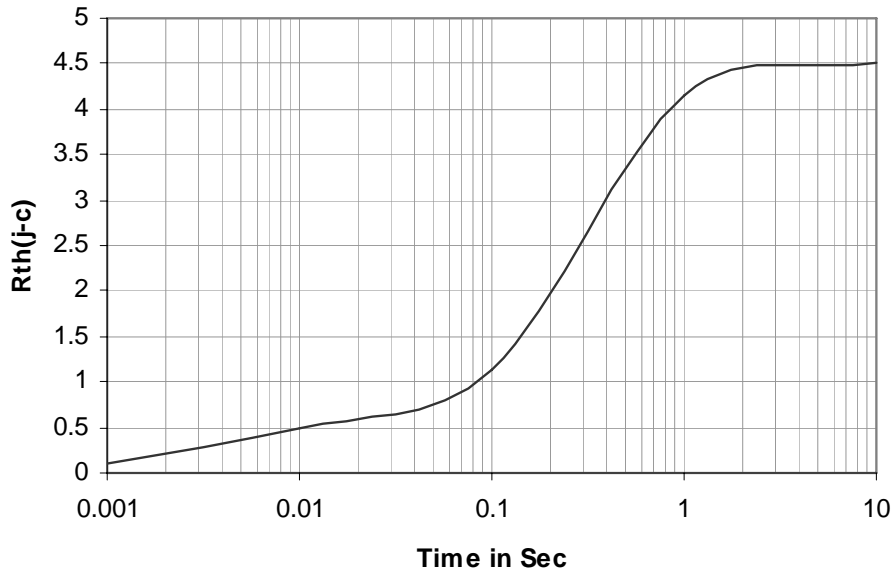

On State Characteristics

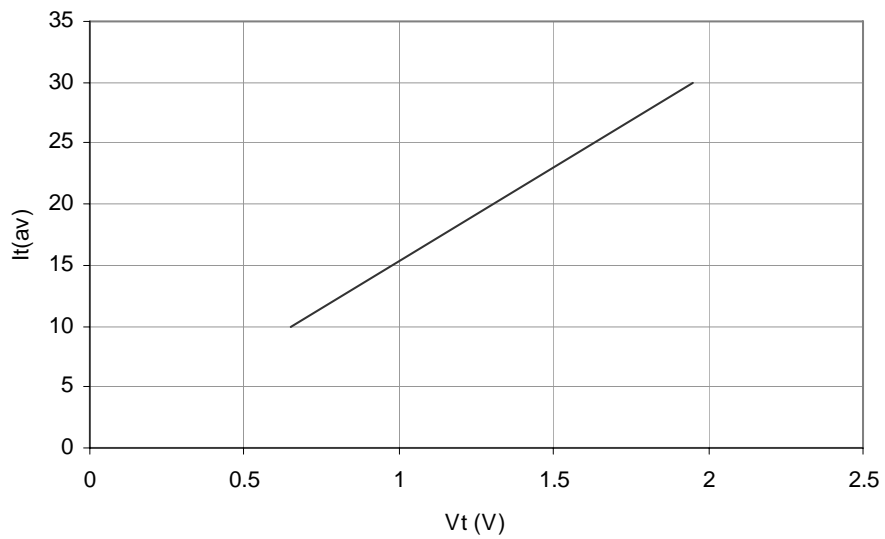

Rectifier Diode SXXHN/HR6

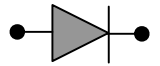

Ordering Information: -

S	XX	HN / HR	6
Hirect make Rectifier Diode	$V_{RRM} = XX * 100$ e.g.12 * 100 =1200V	HN – Normal Polarity HR – Reverse Polarity	$I_{F(AV)} = 6A$

Hind Rectifiers Ltd reserves the right to change the specifications without notice.

This datasheet specifies technical information for semiconductor devices but promises no characteristics. No warranty or guarantee expressed or implied is made regarding delivery, performance or suitability.

Hind Rectifiers Ltd

Lake Road

Bhandup (West)

Mumbai – 400 078

Tel: - +91 22 2596 8027/28/29/31

Fax: - +91 22 2596 4114

E-mail: - marketing@hirect.com

Website: - www.hirect.com

June- 2008



HIND RECTIFIERS LTD

5 of 5