

精度为 $\pm 1^{\circ}\text{C}$ 的8通道温度传感器

概述

MAX6581高精度、多通道温度传感器能够监测其自身温度和7个外部连接成二极管的晶体管温度。所有温度通道具有可编程报警门限和高温门限。当某个通道的测量温度超出门限值时，状态寄存器的相应状态位被置位。根据状态寄存器的状态位触发两个漏极开路报警输出(ALERT和OVERT)。

所有通道均提供电阻抵消功能，用于补偿电路板引线及温度二极管较高的等效串联电阻。

2线串行接口按照SMBus™通信协议(写字节、读字节、发送字节和接收字节)读取温度数据并编程报警门限值。

MAX6581工作在 -40°C 至 $+125^{\circ}\text{C}$ 温度范围，采用24引脚、4mm x 4mm薄型QFN封装，带有裸焊盘。

特性

- ◆ 8个通道用于测量7个远端温度和1个本地温度
- ◆ 11位、 0.125°C 分辨率
- ◆ 在 $+60^{\circ}\text{C}$ 至 $+100^{\circ}\text{C}$ 温度范围内保持 $\pm 1^{\circ}\text{C}$ (最大值)的高精度(远端通道)
- ◆ -64°C 至 $+150^{\circ}\text{C}$ 远端温度测量范围
- ◆ 可编程的低温/高温报警
- ◆ SMBus/I²C兼容接口
- ◆ 两个漏极开路报警输出(ALERT和OVERT)
- ◆ 在所有远端通道提供电阻抵消功能

应用

台式计算机
笔记本电脑
工作站
服务器
数据通信

订购信息/选型指南

PART	SLAVE ADDRESS	PIN-PACKAGE	OPERATING TEMPERATURE RANGE	MEASURED TEMPERATURE RANGE
MAX6581TG9A+	0X9A	24 TQFN-EP*	-40°C to $+125^{\circ}\text{C}$	-64°C to $+150^{\circ}\text{C}$
MAX6581TG9C+**	0X9C	24 TQFN-EP*	-40°C to $+125^{\circ}\text{C}$	-64°C to $+150^{\circ}\text{C}$
MAX6581TG9E+**	0X9E	24 TQFN-EP*	-40°C to $+125^{\circ}\text{C}$	-64°C to $+150^{\circ}\text{C}$
MAX6581TG98+**	0X98	24 TQFN-EP*	-40°C to $+125^{\circ}\text{C}$	-64°C to $+150^{\circ}\text{C}$

+表示无铅(Pb)/符合RoHS标准的封装。

*EP = 裸焊盘。

**未来产品—供货状况请联系工厂。

注：所有器件均工作在 -40°C 至 $+125^{\circ}\text{C}$ 温度范围。

典型应用电路在数据资料的最后给出。

SMBus是Intel Corp.的商标。

精度为 $\pm 1^{\circ}\text{C}$ 的8通道温度传感器

ABSOLUTE MAXIMUM RATINGS

(All Voltages Referenced to GND)

V_{CC} , SMBCLK, SMBDATA, $\overline{\text{ALERT}}$, $\overline{\text{OVERT}}$, STBY to GND.....	-0.3V to +4V
DXP_ to GND.....	-0.3V to ($V_{CC} + 0.3\text{V}$)
DXN_ to GND.....	-0.3V to ($V_{CC} + 0.3\text{V}$)
SMBDATA, $\overline{\text{ALERT}}$, $\overline{\text{OVERT}}$ Current.....	-1mA to +50mA
DXN_ Current.....	$\pm 1\text{mA}$
Continuous Power Dissipation ($T_A = +70^{\circ}\text{C}$) 24-Pin Thin QFN (derate 27.8mW/ $^{\circ}\text{C}$ above $+70^{\circ}\text{C}$) ..	2222mW

Package Junction-to-Ambient Thermal Resistance (θ_{JA}) (Note 1).....	36.0 $^{\circ}\text{C}/\text{W}$
Package Junction-to-Case Thermal Resistance (θ_{JC}) (Note 1).....	3.0 $^{\circ}\text{C}/\text{W}$
ESD Protection (all pins, Human Body Model).....	$\pm 2\text{kV}$
Operating Temperature Range.....	-40°C to $+125^{\circ}\text{C}$
Junction Temperature.....	$+150^{\circ}\text{C}$
Storage Temperature Range.....	-65°C to $+150^{\circ}\text{C}$
Lead Temperature (soldering, 10s).....	$+300^{\circ}\text{C}$
Soldering Temperature (reflow).....	$+260^{\circ}\text{C}$

Note 1: Package thermal resistances were obtained using the method described in JEDEC specification JESD51-7, using a four-layer board. For detailed information on package thermal considerations, refer to china.maxim-ic.com/thermal-tutorial.

Stresses beyond those listed under "Absolute Maximum Ratings" may cause permanent damage to the device. These are stress ratings only, and functional operation of the device at these or any other conditions beyond those indicated in the operational sections of the specifications is not implied. Exposure to absolute maximum rating conditions for extended periods may affect device reliability.

ELECTRICAL CHARACTERISTICS

($V_{CC} = +3.0\text{V}$ to $+3.6\text{V}$, $T_A = -40^{\circ}\text{C}$ to $+125^{\circ}\text{C}$, unless otherwise noted. Typical values are at $V_{CC} = +3.3\text{V}$ and $T_A = +25^{\circ}\text{C}$.) (Note 2)

PARAMETER	SYMBOL	CONDITIONS	MIN	TYP	MAX	UNITS
Supply Voltage	V_{CC}		3.0		3.6	V
Standby Supply Current	I_{SS}	SMBus static		4	15	μA
Operating Current	I_{CC1}	During conversion, RC off		500	600	μA
	I_{CC2}	During conversion, RC on		550	650	
Temperature Resolution				11		Bits
				0.125		$^{\circ}\text{C}$
3-Sigma Temperature Accuracy (Remote Channels 1–7)	$V_{CC} = 3.3\text{V}$	$T_A = +30^{\circ}\text{C}$ to $+85^{\circ}\text{C}$, $T_{RJ} = +60^{\circ}\text{C}$ to $+100^{\circ}\text{C}$	-0.85		+0.85	$^{\circ}\text{C}$
		$T_A, T_{RJ} = -40^{\circ}\text{C}$ to $+125^{\circ}\text{C}$	-1.2		+1.2	
		$T_A = +30^{\circ}\text{C}$ to $+85^{\circ}\text{C}$, $T_{RJ} = +100^{\circ}\text{C}$ to $+150^{\circ}\text{C}$	-2.5		+2.5	
3-Sigma Temperature Accuracy (Local)	$V_{CC} = 3.3\text{V}$	$T_A = +30^{\circ}\text{C}$ to $+85^{\circ}\text{C}$	-1		+1	$^{\circ}\text{C}$
		$T_A = -40^{\circ}\text{C}$ to $+125^{\circ}\text{C}$	-2		+2	
		$T_A = 0^{\circ}\text{C}$ to $+150^{\circ}\text{C}$	-3		+3	
6-Sigma Temperature Accuracy (Remote Channels 1–7)	$V_{CC} = 3.3\text{V}$	$T_A = +30^{\circ}\text{C}$ to $+85^{\circ}\text{C}$, $T_{RJ} = +60^{\circ}\text{C}$ to $+100^{\circ}\text{C}$	-1		+1	$^{\circ}\text{C}$
		$T_A, T_{RJ} = -40^{\circ}\text{C}$ to $+125^{\circ}\text{C}$	-2		+2	
		$T_A = +30^{\circ}\text{C}$ to $+85^{\circ}\text{C}$, $T_{RJ} = +100^{\circ}\text{C}$ to $+125^{\circ}\text{C}$	-2.75		+2.75	
6-Sigma Temperature Accuracy (Local)	$V_{CC} = 3.3\text{V}$	$T_A = +30^{\circ}\text{C}$ to $+85^{\circ}\text{C}$	-1.5		+1.5	$^{\circ}\text{C}$
		$T_A = -40^{\circ}\text{C}$ to $+125^{\circ}\text{C}$	-2.5		+2.5	
		$T_A = 0^{\circ}\text{C}$ to $+150^{\circ}\text{C}$	-3.5		+3.5	
Supply Sensitivity of Temperature Accuracy				± 0.2		$^{\circ}\text{C}/\text{V}$

精度为±1°C的8通道温度传感器

MAX6581

ELECTRICAL CHARACTERISTICS (continued)

(V_{CC} = +3.0V to +3.6V, T_A = -40°C to +125°C, unless otherwise noted. Typical values are at V_{CC} = +3.3V and T_A = +25°C.) (Note 2)

PARAMETER	SYMBOL	CONDITIONS	MIN	TYP	MAX	UNITS	
Conversion Time per Channel	t _{CONV}	Resistance cancellation mode off	95	125	156	ms	
		Resistance cancellation mode on or beta compensation on	190	250	312		
Remote-Diode Source Current	I _{RJ}	High level	Resistance cancellation mode off	80	100	120	μA
		Low level		8	10	12	
		High level	Resistance cancellation mode on or beta compensation on	160	200	240	
		Low level		16	20	24	
DXP_ and DXN_ Leakage Current		Standby mode			100	nA	
Undervoltage Lockout Threshold	UVLO	Falling edge of V _{CC} disables ADC	2.25	2.80	2.95	V	
Undervoltage Lockout Hysteresis				90		mV	
Power-On-Reset (POR) Threshold		V _{CC} falling edge	1.3	2.0	2.2	V	
POR Threshold Hysteresis				90		mV	
ALERT and OVERT							
Output Low Voltage	V _{OL}	I _{SINK} = 1mA			0.01	V	
		I _{SINK} = 6mA			0.3		
Input Leakage Current	I _{LEAK}		-1		+1	μA	
SMBus INTERFACE, STBY							
Logic Input Low Voltage	V _{IL}	V _{CC} = 3.6V			0.8	V	
Logic Input High Voltage	V _{IH}	V _{CC} = 3.0V	2.2			V	
Input Leakage Current			-1		+1	μA	
Output Low Voltage	V _{OL}	I _{SINK} = 6mA			0.1	V	
Input Capacitance	C _{IN}			5		pF	
SMBus-COMPATIBLE TIMING (Figures 3 and 4) (Note 3)							
Serial-Clock Frequency	f _{SMBCLK}	(Note 4)			400	kHz	
Bus Free Time Between STOP and START Condition	t _{BUF}	f _{SMBCLK} = 400kHz	1.6			μs	
START Condition Setup Time		f _{SMBCLK} = 400kHz	0.6			μs	
Repeated START Condition Setup Time	t _{SU:STA}	90% of SMBCLK to 90% of SMBDATA, f _{SMBCLK} = 400kHz	50			ns	
START Condition Hold Time	t _{HD:STA}	10% of SMBDATA to 90% of SMBCLK, f _{SMBCLK} = 400kHz	0.6			μs	
STOP Condition Setup Time	t _{SU:STO}	90% of SMBCLK to 90% of SMBDATA, f _{SMBCLK} = 400kHz	0.6			μs	
Clock Low Period	t _{LOW}	10% to 10%, f _{SMBCLK} = 400kHz	1			μs	
Clock High Period	t _{HIGH}	90% to 90%	0.6			μs	
Data-In Hold Time	t _{HD:DAT}		0		0.9	us	
Data-In Setup Time	t _{SU:DAT}	(Note 5)	100			ns	

精度为 $\pm 1^{\circ}\text{C}$ 的8通道温度传感器

ELECTRICAL CHARACTERISTICS (continued)

($V_{CC} = +3.0\text{V}$ to $+3.6\text{V}$, $T_A = -40^{\circ}\text{C}$ to $+125^{\circ}\text{C}$, unless otherwise noted. Typical values are at $V_{CC} = +3.3\text{V}$ and $T_A = +25^{\circ}\text{C}$.) (Note 2)

PARAMETER	SYMBOL	CONDITIONS	MIN	TYP	MAX	UNITS
Receive SMBCLK/SMBDATA Rise Time	t_R				300	ns
Receive SMBCLK/SMBDATA Fall Time	t_F				300	ns
Data-Out Hold Time	t_{DH}		50			ns
Pulse Width of Spike Suppressed	t_{SP}		0		50	ns
SMBus Timeout	$t_{TIMEOUT}$	SMBDATA low period for interface reset	25	37	45	ms

Note 2: All parameters are tested at $T_A = +85^{\circ}\text{C}$. Specifications over temperature are guaranteed by design.

Note 3: Timing specifications are guaranteed by design.

Note 4: The serial interface resets when SMBCLK is low for more than $t_{TIMEOUT}$.

Note 5: A transition must internally provide at least a hold time to bridge the undefined region (300ns max) of SMBCLK's falling edge.

典型工作特性

($V_{CC} = +3.3\text{V}$, $V_{STBY} = V_{CC}$, $T_A = +25^{\circ}\text{C}$, unless otherwise noted.)

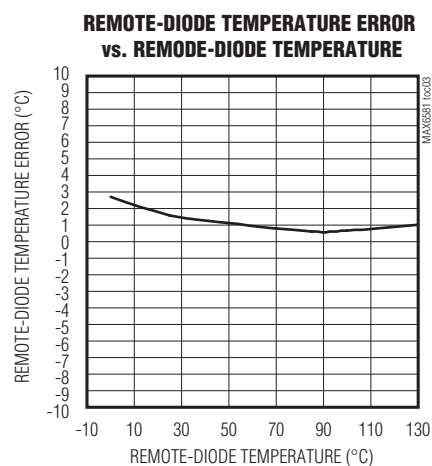
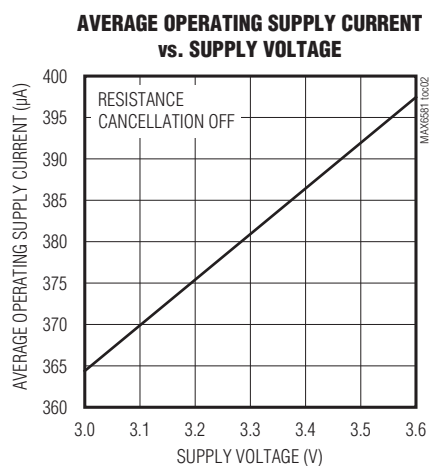
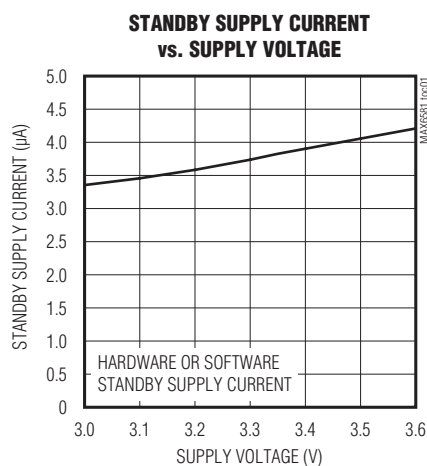

精度为 $\pm 1^{\circ}\text{C}$ 的8通道温度传感器

典型工作特性(续)

($V_{CC} = +3.3\text{V}$, $V_{STBY} = V_{CC}$, $T_A = +25^{\circ}\text{C}$, unless otherwise noted.)

MAX6581

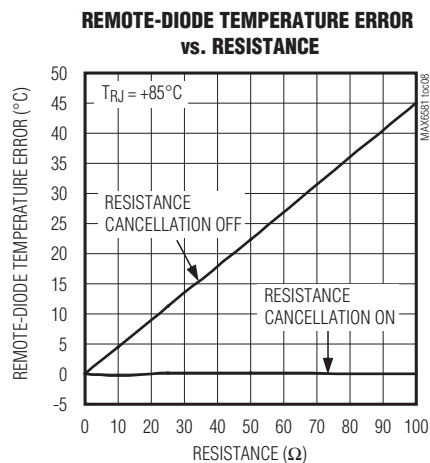
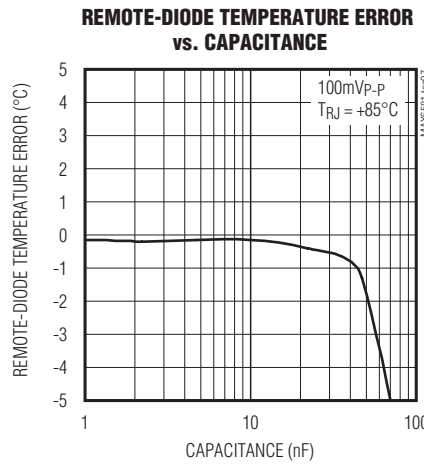
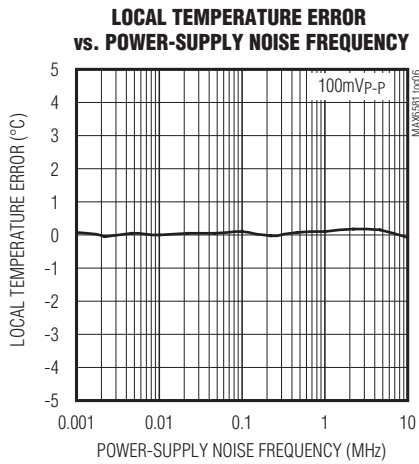
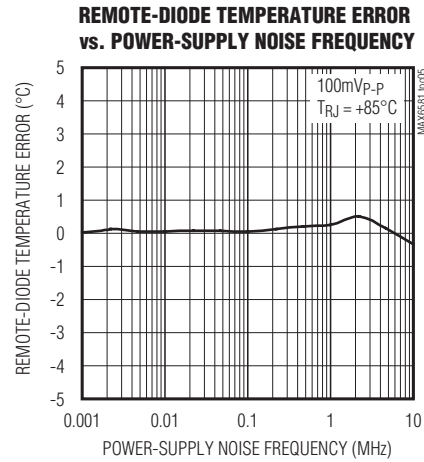
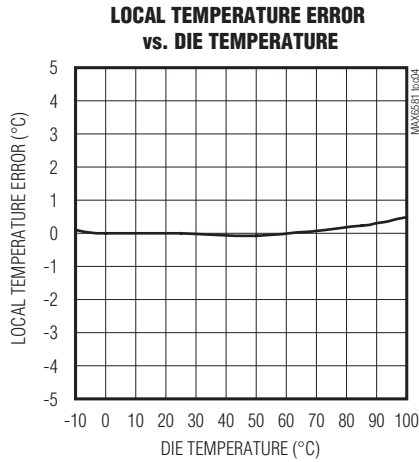

精度为 $\pm 1^{\circ}\text{C}$ 的8通道温度传感器

引脚配置

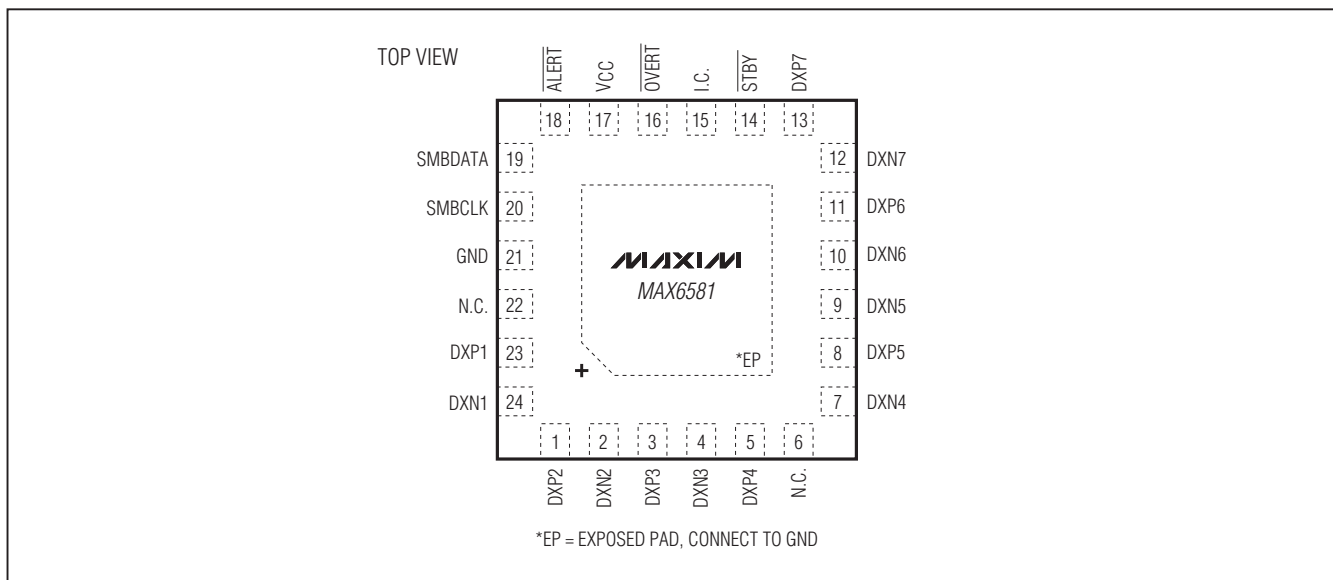

引脚说明

引脚	名称	功能
1	DXP2	通道2远端二极管的电流源和ADC正极组合输入。将DXP2连接至一个远端连接成二极管的温度测量晶体管的阳极。如果未使用远端二极管，则不连接DXP2或将其连接至DXN2。为了滤除噪声，在DXP2和DXN2之间连接一个100pF的电容。
2	DXN2	通道2远端二极管的阴极输入。将通道2远端连接成二极管的晶体管阴极连接至DXN2。如果通道2远端晶体管为衬底pnp管(如：位于CPU管芯)，则将pnp晶体管的基极连接至DXN2。如果未使用远端二极管，则不连接DXN2或将其连接至DXP2。为了滤除噪声，在DXP2和DXN2之间连接一个100pF的电容。
3	DXP3	通道3远端二极管的电流源和ADC正极组合输入。将DXP3连接至一个远端连接成二极管的温度测量晶体管的阳极。如果未使用远端二极管，则不连接DXP3或将其连接至DXN3。为了滤除噪声，在DXP3和DXN3之间连接一个100pF的电容。
4	DXN3	通道3远端二极管的阴极输入。将通道3远端连接成二极管的晶体管阴极连接至DXN3。如果通道3远端晶体管为衬底pnp管(如：位于CPU管芯)，则将pnp晶体管的基极连接至DXN3。如果未使用远端二极管，则不连接DXN3或将其连接至DXP3。为了滤除噪声，在DXP3和DXN3之间连接一个100pF的电容。
5	DXP4	通道4远端二极管的电流源和ADC正极组合输入。将DXP4连接至一个远端连接成二极管的温度测量晶体管的阳极。如果未使用远端二极管，则不连接DXP4或将其连接至DXN4。为了滤除噪声，在DXP4和DXN4之间连接一个100pF的电容。
6, 22	N.C.	无连接。连接至其它N.C.引脚或不连接。

精度为 $\pm 1^{\circ}\text{C}$ 的8通道温度传感器

引脚说明(续)

MAX6581

引脚	名称	功能
7	DXN4	通道4远端二极管的阴极输入。将通道4远端连接成二极管的晶体管阴极连接至DXN4。如果通道4远端晶体管为衬底pnp管(如: 位于CPU管芯), 则将pnp晶体管的基极连接至DXN4。如果未使用远端二极管, 则不连接DXN4或将其连接至DXP4。为了滤除噪声, 在DXP4和DXN4之间连接一个100pF的电容。
8	DXP5	通道5远端二极管的电流源和ADC正极组合输入。将DXP5连接至一个远端连接成二极管的温度测量晶体管的阳极。如果未使用远端二极管, 则不连接DXP5或将其连接至DXN5。为了滤除噪声, 在DXP5和DXN5之间连接一个100pF的电容。
9	DXN5	通道5远端二极管的阴极输入。将通道5远端连接成二极管的晶体管阴极连接至DXN5。如果通道5远端晶体管为衬底pnp管(如: 位于CPU管芯), 则将pnp晶体管的基极连接至DXN5。如果未使用远端二极管, 则不连接DXN5或将其连接至DXP5。为了滤除噪声, 在DXP5和DXN5之间连接一个100pF的电容。
10	DXN6	通道6远端二极管的阴极输入。将通道6远端连接成二极管的晶体管阴极连接至DXN6。如果通道6远端晶体管为衬底pnp管(如: 位于CPU管芯), 则将pnp晶体管的基极连接至DXN6。如果未使用远端二极管, 则不连接DXN6或将其连接至DXP6。为了滤除噪声, 在DXP6和DXN6之间连接一个100pF的电容。
11	DXP6	通道6远端二极管的电流源和ADC正极组合输入。将DXP6连接至一个远端连接成二极管的温度测量晶体管的阳极。如果未使用远端二极管, 则不连接DXP6或将其连接至DXN6。为了滤除噪声, 在DXP6和DXN6之间连接一个100pF的电容。
12	DXN7	通道7远端二极管的阴极输入。将通道7远端连接成二极管的晶体管阴极连接至DXN7。如果通道7远端晶体管为衬底pnp管(如: 位于CPU管芯), 则将pnp晶体管的基极连接至DXN7。如果未使用远端二极管, 则不连接DXN7或将其连接至DXP7。为了滤除噪声, 在DXP7和DXN7之间连接一个100pF的电容。
13	DXP7	通道7远端二极管的电流源和ADC正极组合输入。将DXP7连接至一个远端连接成二极管的温度测量晶体管的阳极。如果未使用远端二极管, 则不连接DXP7或将其连接至DXN7。为了滤除噪声, 在DXP7和DXN7之间连接一个100pF的电容。
14	$\overline{\text{STBY}}$	低电平有效待机输入。驱动 $\overline{\text{STBY}}$ 至逻辑低电平, 将MAX6581置于待机模式; 驱动至逻辑高电平, 进入正常工作模式。在待机模式下, 温度和门限数据不会丢失。
15	I.C.	内部连接。I.C.在内部连接至 V_{CC} , 将I.C.连接至 V_{CC} 或者不连接。
16	$\overline{\text{OVERT}}$	低电平有效、漏极开路、高温指示输出。当任一路远端通道的温度超出预设的门限后, $\overline{\text{OVERT}}$ 将变为逻辑低电平。
17	V_{CC}	电源电压输入。采用一个0.1 μF 的电容旁路至GND。
18	$\overline{\text{ALERT}}$	低电平有效、漏极开路、SMBus报警(中断)输出。当任一路通道的温度超出预设的 $\overline{\text{ALERT}}$ 上限或下限后, $\overline{\text{ALERT}}$ 将变为逻辑低电平。
19	SMBDATA	SMBus串行数据输入/输出。将SMBDATA连接至一个上拉电阻。
20	SMBCLK	SMBus串行时钟输入。将SMBCLK连接至一个上拉电阻。

精度为±1°C的8通道温度传感器

引脚说明(续)

引脚	名称	功能
21	GND	地。
23	DXP1	通道1远端二极管的电流源和ADC正极组合输入。将DXP1连接至一个远端连接成二极管的温度测量晶体管的阳极。如果未使用远端二极管，则不连接DXP1或将其连接至DXN1。为了滤除噪声，在DXP1和DXN1之间连接一个100pF的电容。
24	DXN1	通道1远端二极管的阴极输入。将通道1远端连接成二极管的晶体管阴极连接至DXN1。如果通道1远端晶体管为衬底pnp管(如：位于CPU管芯)，则将pnp晶体管的基极连接至DXN1。如果未使用远端二极管，则不连接DXN1或将其连接至DXP1。为了滤除噪声，在DXP1和DXN1之间连接一个100pF的电容。
—	EP	裸焊盘。将EP连接至GND。

详细说明

MAX6581是一款高精度多通道温度监测器，具有一路本地通道和七路远端测温通道，每一个温度通道都具有可编程的报警门限，通道1-7还具有可编程的高温门限(参见图1)。MAX6581可通过SMBus串口进行通信，并具有一个专用的报警引脚(ALERT)。如果超出了软件编程的温度门限，将触发报警输出(OVERT和ALERT)。当测量温度值低于ALERT下限时，也会触发ALERT。ALERT通常用作中断输出，OVERT则可连接至风扇、系统关断或其它热管理电路。

ADC转换顺序

MAX6581的转换顺序为首先测量通道1上的温度，然后依次为通道2、本地通道、通道3-7。每一个有效通道的转换结果保存在相应的温度数据寄存器中。若通道不包含二极管，则不执行转换。

低功耗待机模式

将配置寄存器中的STOP位置为1，可进入软件待机模式；将STBY引脚拉低，则可进入硬件待机模式。在软件待机模式下，ADC被禁用，电源电流降至4μA左右。无论是软件待机还是硬件待机，存储器中的数据都不会丢失。在硬件待机期间，SMBus接口不工作；在软件待机期间，SMBus

接口保持工作，并随时等待接收命令。如果在SMBus总线上出现START条件，则使能超时功能。SMBus总线上的活动状态会导致电源电流增大。如果在转换期间接收到待机命令，将中断转换过程，温度寄存器将不会被刷新。上次的数据将维持不变，并保持可用。

工作电流计算

MAX6581具有多个不同的工作电流等级，具体取决于所使用的外部通道数量以及处于电阻抵消(RC)模式的通道数量。平均工作电流为：

$$I_{AV} = \frac{N_N + 1}{N_N + 2 \times N_R + 1} I_{CC1} + \frac{2 \times N_R}{N_N + 2 \times N_R + 1} \times I_{CC2}$$

其中：

N_N = 正常工作模式下的远端通道数。

N_R = 处于RC模式的远端通道数。

I_{AV} = 完成所有转换的平均电源电流。

I_{CC1} = 正常工作模式下，一次转换期间的平均电源电流。

I_{CC2} = RC模式下，一次转换期间的平均电源电流。

精度为 $\pm 1^{\circ}\text{C}$ 的8通道温度传感器

MAX6581



图1. 内部框图

精度为 $\pm 1^{\circ}\text{C}$ 的8通道温度传感器

SMBus数字接口

从软件角度看，MAX6581相当于一系列8位寄存器，其中包括温度测量数据、报警门限和控制位。可采用标准的SMBus兼容2线串口来读取温度数据、写控制位和报警门限数据。用相同的SMBus从地址来操作所有功能。

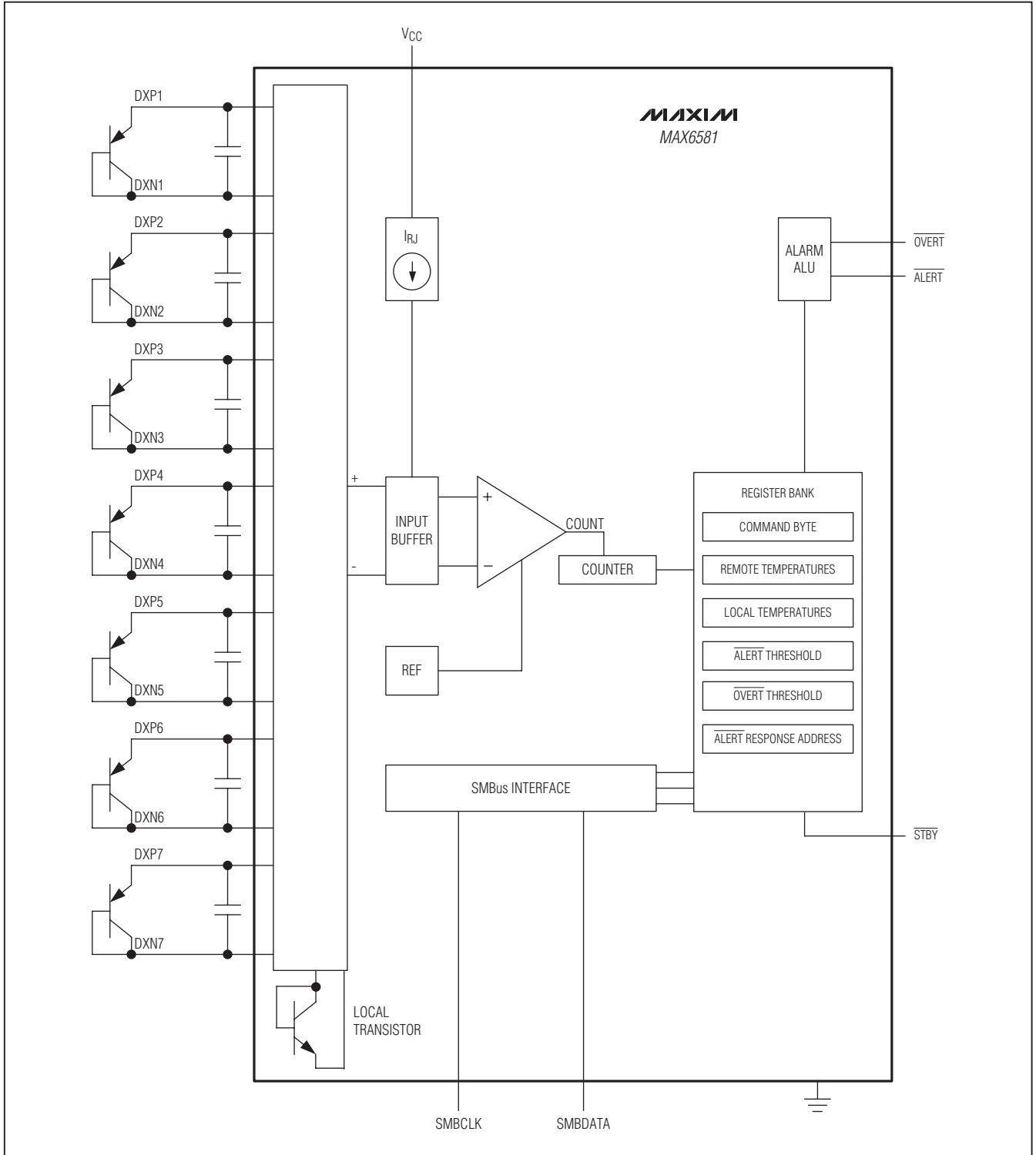
MAX6581采用了四种标准的SMBus协议：写字节、读字节、发送字节和接收字节(图2)。如果之前已经利用一条读字节命令选中了正确的数据寄存器，则可以使用精简的接收字节协议加快传输。在多主机系统中，由于第二个主控制器可在不通告第一主控制器的情况下覆盖命令字节，所以使用精简协议时要格外注意。图3为SMBus总线的写操作时序图，图4为SMBus总线的读操作时序图。

远端二极管测量通道提供了11位数据(1 LSB = 0.125°C)。8个最高有效位(MSB)可从本地温度寄存器和远端温度寄存器中读取，远端温度的其它3位可从扩展温度寄存器读取。如果需要扩展分辨率，则应该首先读取扩展分辨率寄存器。这样可防止读取最高有效位之前，新的转换结果将其覆盖。在SMBus总线的超时周期内(通常为37ms)，如果最高有效位未被读取，将会进行正常的刷新。表1所示为主温度寄存器(高字节)的数据格式，表2所示为扩展分辨率寄存器(低字节)的数据格式。



图2. SMBus总线协议

精度为±1°C的8通道温度传感器

MAX6581

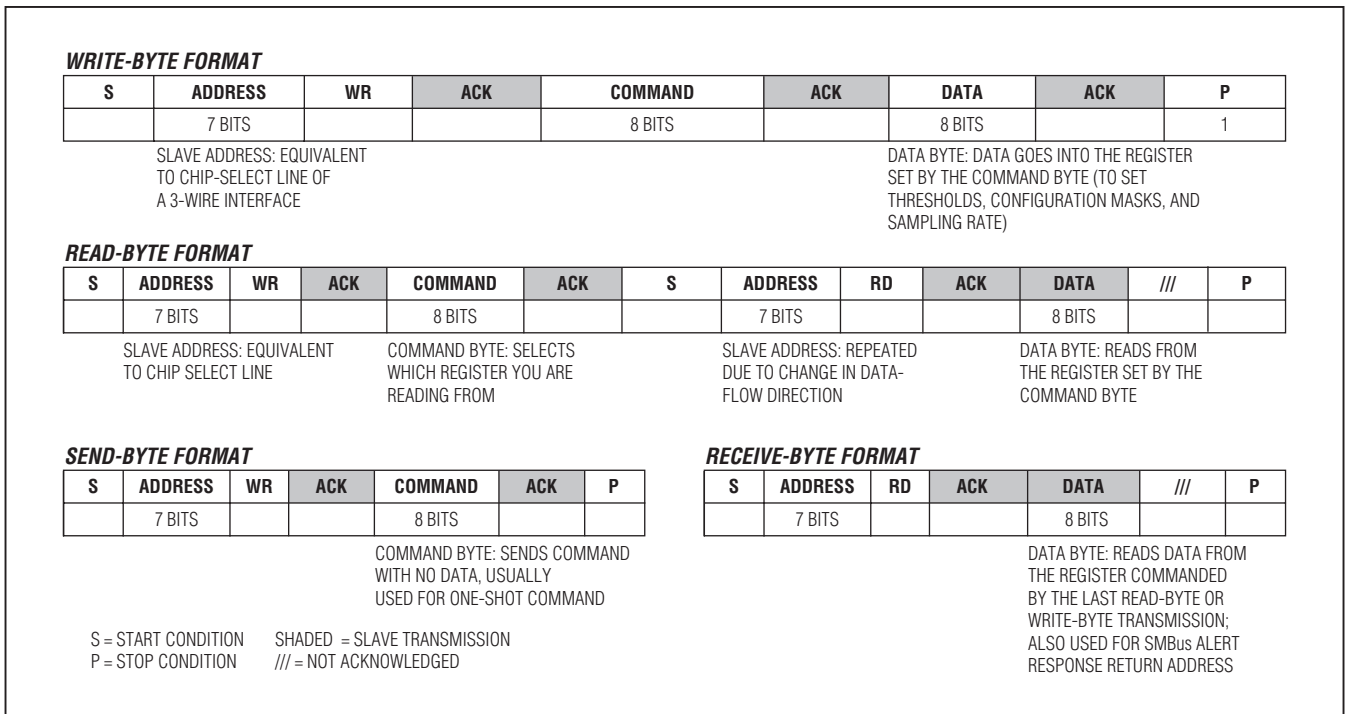

图3. SMBus写操作时序图



图4. SMBus读操作时序图

表1. 主温度寄存器(高字节)数据格式

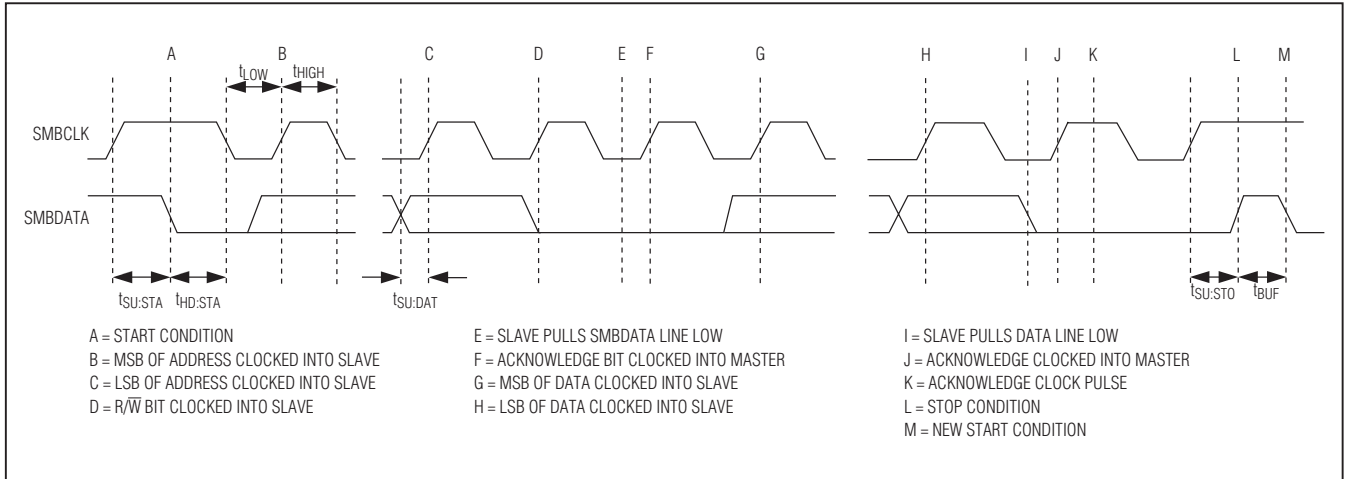
TEMPERATURE (°C)	DIGITAL OUTPUT	
	NORMAL FORMAT	EXTENDED FORMAT
Diode fault (open or short)	1111 1111	1111 1111
> +191	1111 1111	1111 1111
+191	1111 1111	1111 1111
+150	1101 0110	1100 1100
+127	1011 1111	1011 1111
+25	0101 1001	1001 1001
0	0100 0000	0100 0000
-39	0001 1001	0101 1001
-64	0000 0000	0000 0000
< -64	0000 0000	0000 0000

精度为 $\pm 1^{\circ}\text{C}$ 的8通道温度传感器

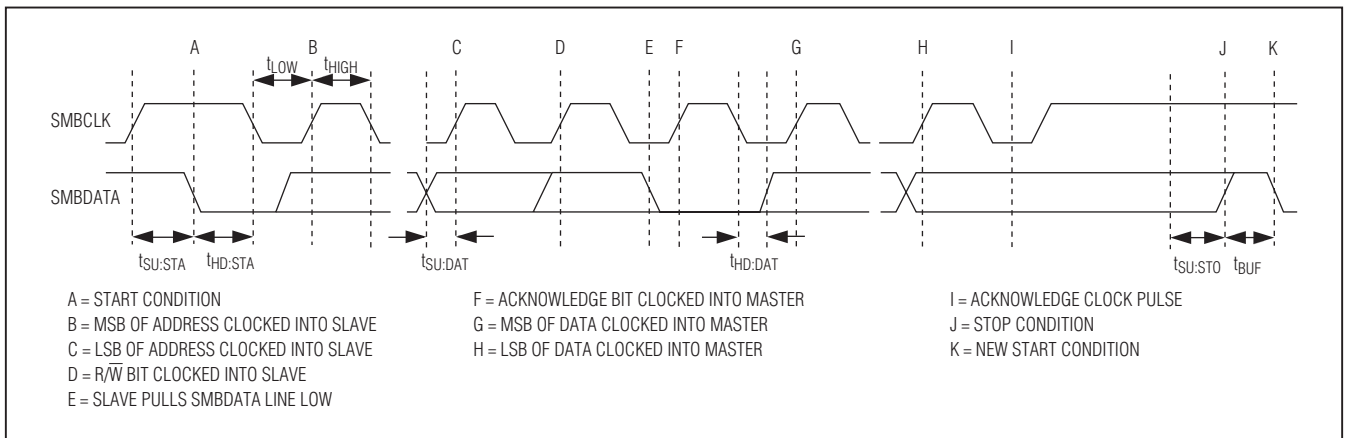
表2. 扩展分辨率温度寄存器(低字节)数据格式

TEMPERATURE ($^{\circ}\text{C}$)	DIGITAL OUTPUT
0	000X XXXX
+0.125	001X XXXX
+0.250	010X XXXX
+0.375	011X XXXX
+0.500	100X XXXX
+0.625	101X XXXX
+0.750	110X XXXX
+0.875	111X XXXX

X = 无关。

表3. 命令字节寄存器位分配

REGISTER	ADDRESS (HEX)	POR VALUE (HEX)	READ/ WRITE	DESCRIPTION
Remote 1	01	00	R	Read channel 1 remote temperature
Remote 2	02	00	R	Read channel 2 remote temperature
Remote 3	03	00	R	Read channel 3 remote temperature
Remote 4	04	00	R	Read channel 4 remote temperature
Remote 5	05	00	R	Read channel 5 remote temperature
Remote 6	06	00	R	Read channel 6 remote temperature
Local	07	00	R	Read local temperature
Remote 7	08	00	R	Read channel 7 remote temperature
Remote 1 Extended Bits*	09	00	R	Read channel 1 remote-diode extended temperature
Manufacturer ID	0A	4D	R	Read manufacturer ID
Revision ID	0F	00	R	Read revision ID
Remote 1 $\overline{\text{ALERT}}$ High Limit	11	7F	R/W	Read/write channel 1 remote-diode alert high-temperature threshold limit
Remote 2 $\overline{\text{ALERT}}$ High Limit	12	7F	R/W	Read/write channel 2 remote-diode alert high-temperature threshold limit
Remote 3 $\overline{\text{ALERT}}$ High Limit	13	64	R/W	Read/write channel 3 remote-diode alert high-temperature threshold limit
Remote 4 $\overline{\text{ALERT}}$ High Limit	14	64	R/W	Read/write channel 4 remote-diode alert high-temperature threshold limit
Remote 5 $\overline{\text{ALERT}}$ High Limit	15	64	R/W	Read/write channel 5 remote-diode alert high-temperature threshold limit
Remote 6 $\overline{\text{ALERT}}$ High Limit	16	64	R/W	Read/write channel 6 remote-diode alert high-temperature threshold limit
Local $\overline{\text{ALERT}}$ High Limit	17	5A	R/W	Read/write local-diode alert high-temperature threshold limit
Remote 7 $\overline{\text{ALERT}}$ High Limit	18	64	R/W	Read/write channel 7 remote-diode alert high-temperature threshold limit
Local $\overline{\text{OVERT}}$ High Limit	20	50	R/W	Read/write channel local-diode overtemperature threshold limit

精度为 $\pm 1^{\circ}\text{C}$ 的8通道温度传感器

MAX6581

表3. 命令字节寄存器位分配(续)

REGISTER	ADDRESS (HEX)	POR VALUE (HEX)	READ/ WRITE	DESCRIPTION
Remote 1 $\overline{\text{OVERT}}$ High Limit	21	6E	R/W	Read/write channel 1 remote-diode overtemperature threshold limit
Remote 2 $\overline{\text{OVERT}}$ High Limit	22	6E	R/W	Read/write channel 2 remote-diode overtemperature threshold limit
Remote 3 $\overline{\text{OVERT}}$ High Limit	23	6E	R/W	Read/write channel 3 remote-diode overtemperature threshold limit
Remote 4 $\overline{\text{OVERT}}$ High Limit	24	7F	R/W	Read/write channel 4 remote-diode overtemperature threshold limit
Remote 5 $\overline{\text{OVERT}}$ High Limit	25	5A	R/W	Read/write channel 5 remote-diode overtemperature threshold limit
Remote 6 $\overline{\text{OVERT}}$ High Limit	26	5A	R/W	Read/write channel 6 remote-diode overtemperature threshold limit
Remote 7 $\overline{\text{OVERT}}$ High Limit	27	5A	R/W	Read/write channel 7 remote-diode overtemperature threshold limit
$\overline{\text{ALERT}}$ Low Limits (all channels)	30	00	R/W	Read/write all channels alert low-temperature threshold limit
Configuration	41	00	R/W	Read/write configuration
$\overline{\text{ALERT}}$ Mask	42	00	R/W	Read/write $\overline{\text{ALERT}}$ mask
$\overline{\text{OVERT}}$ Mask	43	00	R/W	Read/write $\overline{\text{OVERT}}$ mask
$\overline{\text{ALERT}}$ High Status	44	00	R	Read $\overline{\text{ALERT}}$ high status
$\overline{\text{OVERT}}$ Status	45	00	R	Read $\overline{\text{OVERT}}$ status
Diode Fault Status	46	00	R	Read diode fault status
$\overline{\text{ALERT}}$ Low Status	47	00	R	Read $\overline{\text{ALERT}}$ low status
$\overline{\text{ALERT}}$ Low Disable	48	FF	R/W	Read/write $\overline{\text{ALERT}}$ low disable
Resistance Cancellation	4A	00	R/W	Read/write resistance cancellation enable bits (1 = On, 0 = Off)
Transistor Ideality	4B	00	R/W	Read/write ideality value for remote-sense transistor
Ideality Select	4C	00	R/W	Read/write ideality value selection bits (1 = selected transistor ideality, 0 = 1.008)
Offset	4D	00	R/W	Read/write temperature offset value
Offset Select	4E	00	R/W	Read/write offset value selection bits (1 = value in Offset Select register, 0 = 0)
Remote 1 Extended Bits*	51	00	R	Read channel 1 remote extended temperature
Remote 2 Extended Bits	52	00	R	Read channel 2 remote extended temperature
Remote 3 Extended Bits	53	00	R	Read channel 3 remote extended temperature
Remote 4 Extended Bits	54	00	R	Read channel 4 remote extended temperature
Remote 5 Extended Bits	55	00	R	Read channel 5 remote extended temperature
Remote 6 Extended Bits	56	00	R	Read channel 6 remote extended temperature
Local Extended Bits	57	00	R	Read local channel extended temperature

*重复输入。

精度为 $\pm 1^{\circ}\text{C}$ 的8通道温度传感器

二极管故障检测

如果某个通道的输入DXP_和DXN_发生开路或短路，MAX6581则会检测到二极管故障。二极管开路故障不会触发 $\overline{\text{ALERT}}$ 或 $\overline{\text{OVERT}}$ 。状态寄存器中与该通道对应的状态位将被置为1，该通道的温度数据将被保存为全1 (FFh)。MAX6581检测二极管故障需要大约4ms的时间。一旦检测到二极管故障，MAX6581就会跳至转换顺序中的下一个通道。

报警门限寄存器

有17个报警门限寄存器，用来存储高温和低温 $\overline{\text{ALERT}}$ 和 $\overline{\text{OVERT}}$ 门限值。其中九个寄存器专门用于存储本地报警高温门限、七个远端报警高温门限以及一个所有通道共有的报警低温门限(参见 $\overline{\text{ALERT}}$ 中断模式部分)。其余八个寄存器专用于存储本地通道高温门限和七个远端通道的高温门限(参见 $\overline{\text{OVERT}}$ 高温报警部分)。可通过SMBus接口访问这些寄存器。

$\overline{\text{ALERT}}$ 中断模式

当内部或外部温度读数超出温度上限(用户可编程)或下限值时，将产生 $\overline{\text{ALERT}}$ 中断。通过读取与故障相关的状态寄存器，或者成功响应主控制器发送的报警响应地址，即可将 $\overline{\text{ALERT}}$ 中断输出信号清除。这两种情况下，如果故障条件依然存在，报警会被清除，但在下一次转换结束时会重新触发。中断不会中止自动转换过程。 $\overline{\text{ALERT}}$ 为漏极开路输出，所以可多个器件共享中断信号线。通过 $\overline{\text{ALERT}}$ 屏蔽寄存器(42h)可屏蔽掉所有的 $\overline{\text{ALERT}}$ 中断。表3所示为这些寄存器的POR状态。

$\overline{\text{ALERT}}$ 响应地址

SMBus总线的报警响应中断指针为那些缺少作为总线主控制器所必需的复杂逻辑电路的从设备提供了快速识别故障的渠道。当接收到中断信号时，主控制器可向报警响应地址(19h)广播一个接收字节。那么发生了中断的任何从设备均可将其地址放在总线上，从而对自身进行识别。

报警响应可同时激活几个不同的从设备，类似于I²C中的广播(general call)。如果多个从设备试图响应，总线将启动仲裁

规则，具有较低地址码的设备优先。未获得响应的设备不产生应答，继续将 $\overline{\text{ALERT}}$ 信号线保持为逻辑低状态，直到被清除(清除报警的条件取决于从设备的类型)。成功完成报警响应协议后，将清除输出锁定。如果导致报警的条件依然存在，MAX6581将会在下次转换结束后重新触发 $\overline{\text{ALERT}}$ 中断。

$\overline{\text{OVERT}}$ 高温报警

MAX6581有八个高温寄存器，用以保存 $\overline{\text{OVERT}}$ 输出的报警门限数据。当某一通道的测量温度值大于相应门限寄存器中存储的值时，将触发 $\overline{\text{OVERT}}$ 。 $\overline{\text{OVERT}}$ 将保持有效，直到温度下降至低于所设置的门限再减去4°C的滞回。高温输出可用来启动冷却风扇、发送警告、启动时钟减速或者触发系统关断，以防元件损坏。关于高温门限寄存器的POR状态，请参见表3。

命令字节寄存器功能

8位命令字节寄存器(表3)是指向于MAX6581内其它各寄存器的主索引。该寄存器的POR状态为0000 0000 (00h)。

配置寄存器(41h)

配置寄存器(表4)有几项功能。第7位(MSB)可将MAX6581置于软件待机模式(STOP)或连续转换模式。第6位将所有寄存器复位至POR状态，然后将本身清除。第5位禁用SMBus超时。第1位用于扩展远端温度二极管的测温范围。配置寄存器的其它位没有用。该寄存器的POR状态为0000 0000 (00h)。

$\overline{\text{ALERT}}$ 屏蔽寄存器(42h)

$\overline{\text{ALERT}}$ 屏蔽寄存器的功能说明请参见表5。位[7:0]用于屏蔽 $\overline{\text{ALERT}}$ 中断输出。第6位可屏蔽本地报警中断，其余各位用于屏蔽远端报警中断。该寄存器的上电状态为0000 0000 (00h)。

$\overline{\text{OVERT}}$ 屏蔽寄存器(43h)

表6给出了 $\overline{\text{OVERT}}$ 屏蔽寄存器的说明。第6位和其余各位用于屏蔽所有通道的 $\overline{\text{OVERT}}$ 中断输出。该寄存器的上电状态为0000 0000 (00h)。

精度为 $\pm 1^{\circ}\text{C}$ 的8通道温度传感器

表4. 配置寄存器(41h)

BIT	NAME	POR VALUE	FUNCTION
7 (MSB)	STOP	0	Standby-Mode Control Bit. If STOP is set to logic 1, the MAX6581 stops converting and enters standby mode.
6	POR	0	Reset Bit. Set to logic 1 to put the device into its power-on state. This bit is self-clearing.
5	$\overline{\text{TIMEOUT}}$	0	Timeout Enable Bit. Set to logic 0 to enable SMBus timeout.
4	RESERVED	0	Reserved. Must be set to 0.
3	RESERVED	0	Reserved. Must be set to 0.
2	RESERVED	0	Reserved. Must be set to 0.
1	EXTRANGE	0	Extended-Range Enable Bit. Set bit 1 to logic 1 to set the temperature and limit data range to -64°C to $+191^{\circ}\text{C}$. Set bit 1 to logic 0 to set the range to 0°C to $+255^{\circ}\text{C}$.
0	RESERVED	0	Reserved. Must be set to 0.

表5. $\overline{\text{ALERT}}$ 屏蔽寄存器(42h)

BIT	NAME	POR VALUE	FUNCTION
7 (MSB)	Mask $\overline{\text{ALERT}}$ 7	0	Channel 7 Alert Mask. Set to logic 1 to mask channel 7 $\overline{\text{ALERT}}$.
6	Mask Local $\overline{\text{ALERT}}$	0	Local Alert Mask. Set to logic 1 to mask local channel $\overline{\text{ALERT}}$.
5	Mask $\overline{\text{ALERT}}$ 6	0	Channel 6 Alert Mask. Set to logic 1 to mask channel 6 $\overline{\text{ALERT}}$.
4	Mask $\overline{\text{ALERT}}$ 5	0	Channel 5 Alert Mask. Set to logic 1 to mask channel 5 $\overline{\text{ALERT}}$.
3	Mask $\overline{\text{ALERT}}$ 4	0	Channel 4 Alert Mask. Set to logic 1 to mask channel 4 $\overline{\text{ALERT}}$.
2	Mask $\overline{\text{ALERT}}$ 3	0	Channel 3 Alert Mask. Set to logic 1 to mask channel 3 $\overline{\text{ALERT}}$.
1	Mask $\overline{\text{ALERT}}$ 2	0	Channel 2 Alert Mask. Set to logic 1 to mask channel 2 $\overline{\text{ALERT}}$.
0	Mask $\overline{\text{ALERT}}$ 1	0	Channel 1 Alert Mask. Set to logic 1 to mask channel 1 $\overline{\text{ALERT}}$.

表6. $\overline{\text{OVERT}}$ 屏蔽寄存器(43h)

BIT	NAME	POR VALUE	FUNCTION
7 (MSB)	Mask $\overline{\text{OVERT}}$ 7	0	Channel 7 Remote-Diode $\overline{\text{OVERT}}$ Mask Bit. Set to logic 1 to mask channel 7 $\overline{\text{OVERT}}$.
6	Mask Local $\overline{\text{OVERT}}$	0	Local Overt Mask. Set to logic 1 to mask local channel $\overline{\text{OVERT}}$.
5	Mask $\overline{\text{OVERT}}$ 6	0	Channel 6 Remote-Diode $\overline{\text{OVERT}}$ Mask Bit. Set to logic 1 to mask channel 6 $\overline{\text{OVERT}}$.
4	Mask $\overline{\text{OVERT}}$ 5	0	Channel 5 Remote-Diode $\overline{\text{OVERT}}$ Mask Bit. Set to logic 1 to mask channel 5 $\overline{\text{OVERT}}$.
3	Mask $\overline{\text{OVERT}}$ 4	0	Channel 4 Remote-Diode $\overline{\text{OVERT}}$ Mask Bit. Set to logic 1 to mask channel 4 $\overline{\text{OVERT}}$.
2	Mask $\overline{\text{OVERT}}$ 3	0	Channel 3 Remote-Diode $\overline{\text{OVERT}}$ Mask Bit. Set to logic 1 to mask channel 3 $\overline{\text{OVERT}}$.
1	Mask $\overline{\text{OVERT}}$ 2	0	Channel 2 Remote-Diode $\overline{\text{OVERT}}$ Mask Bit. Set to logic 1 to mask channel 2 $\overline{\text{OVERT}}$.
0	Mask $\overline{\text{OVERT}}$ 1	0	Channel 1 Remote-Diode $\overline{\text{OVERT}}$ Mask Bit. Set to logic 1 to mask channel 1 $\overline{\text{OVERT}}$.

精度为 $\pm 1^{\circ}\text{C}$ 的8通道温度传感器

状态寄存器功能

器件共有4个状态寄存器(参见表7至表10)。 $\overline{\text{ALERT}}$ 高温状态寄存器指示测得的本地或远端温度值是否超出 $\overline{\text{ALERT}}$ 上限寄存器中设置的相应门限值。 $\overline{\text{OVERT}}$ 状态寄存器指示测得的温度值是否超出 $\overline{\text{OVERT}}$ 上限寄存器中设置的相应门限值。二极管故障状态寄存器指示任一路远端测量通道是否发生二极管故障(开路或短路)。 $\overline{\text{ALERT}}$ 低温状态寄存器指示测得的本地或远端二极管温度值是否低于 $\overline{\text{ALERT}}$ 下限寄存器中设置的门限值。

报警状态寄存器被成功读取后, 其中的状态位将被清除, 但是除非故障已经清除(测得的温度值降低或门限值提高), 否则将会在下次转换完成后重新置位。

$\overline{\text{ALERT}}$ 中断输出跟随状态标识位的变化。一旦触发 $\overline{\text{ALERT}}$ 输出, 可通过读取 $\overline{\text{ALERT}}$ 高温状态寄存器或者成功响应报警响应地址将其清除。这两种情况下, 即使故障条件依然存在, 报警也会被清除, 但是在下一次转换结束时再次触发 $\overline{\text{ALERT}}$ 输出。

只有在测得的温度值下降至低于温度门限减去滞回值(4°C), 或者当温度门限设置为比当前温度至少高 4°C 时, 才会清除指示 $\overline{\text{OVERT}}$ 故障的状态位。

表7. $\overline{\text{ALERT}}$ 高温状态寄存器(44h)

BIT	NAME	POR STATE	FUNCTION
7 (MSB)	Remote $\overline{\text{ALERT}}$ High 7	0	Channel 7 Remote-Diode High-Alert Bit. This bit is set to logic 1 when the channel 7 remote-diode temperature exceeds the programmed temperature threshold limit in the Remote 7 $\overline{\text{ALERT}}$ High Limit register.
6	Local $\overline{\text{ALERT}}$ High	0	Local Channel High-Alert Bit. This bit is set to logic 1 when the local temperature exceeds the temperature threshold limit in the Local $\overline{\text{ALERT}}$ High Limit register.
5	Remote $\overline{\text{ALERT}}$ High 6	0	Channel 6 Remote-Diode High-Alert Bit. This bit is set to logic 1 when the channel 6 remote-diode temperature exceeds the programmed temperature threshold limit in the Remote 6 $\overline{\text{ALERT}}$ High Limit register.
4	Remote $\overline{\text{ALERT}}$ High 5	0	Channel 5 Remote-Diode High-Alert Bit. This bit is set to logic 1 when the channel 5 remote-diode temperature exceeds the programmed temperature threshold limit in the Remote 5 $\overline{\text{ALERT}}$ High Limit register.
3	Remote $\overline{\text{ALERT}}$ High 4	0	Channel 4 Remote-Diode High-Alert Bit. This bit is set to logic 1 when the channel 4 remote-diode temperature exceeds the programmed temperature threshold limit in the Remote 4 $\overline{\text{ALERT}}$ High Limit register.
2	Remote $\overline{\text{ALERT}}$ High 3	0	Channel 3 Remote-Diode High-Alert Bit. This bit is set to logic 1 when the channel 3 remote-diode temperature exceeds the programmed temperature threshold limit in the Remote 3 $\overline{\text{ALERT}}$ High Limit register.
1	Remote $\overline{\text{ALERT}}$ High 2	0	Channel 2 Remote-Diode High-Alert Bit. This bit is set to logic 1 when the channel 2 remote-diode temperature exceeds the programmed temperature threshold limit in the Remote 2 $\overline{\text{ALERT}}$ High Limit register.
0	Remote $\overline{\text{ALERT}}$ High 1	0	Channel 1 Remote-Diode High-Alert Bit. This bit is set to logic 1 when the channel 1 remote-diode temperature exceeds the programmed temperature threshold limit in the Remote 1 $\overline{\text{ALERT}}$ High Limit register.

精度为 $\pm 1^{\circ}\text{C}$ 的8通道温度传感器

表8. $\overline{\text{OVERT}}$ 状态寄存器(45h)

BIT	NAME	POR STATE	FUNCTION
7 (MSB)	Remote $\overline{\text{OVERT}}$ 7	0	Channel 7 Remote-Diode Overtemperature Status Bit. This bit is set to logic 1 when the channel 7 remote-diode temperature exceeds the temperature threshold limit in the Remote 7 $\overline{\text{OVERT}}$ High Limit register.
6	Local $\overline{\text{OVERT}}$	0	Local Channel Overtemperature Status Bit. This bit is set to logic 1 when the local temperature exceeds the temperature threshold limit in the Local $\overline{\text{OVERT}}$ High Limit register.
5	Remote $\overline{\text{OVERT}}$ 6	0	Channel 6 Remote-Diode Overtemperature Status Bit. This bit is set to logic 1 when the channel 6 remote-diode temperature exceeds the temperature threshold limit in the Remote 6 $\overline{\text{OVERT}}$ High Limit register.
4	Remote $\overline{\text{OVERT}}$ 5	0	Channel 5 Remote-Diode Overtemperature Status Bit. This bit is set to logic 1 when the channel 5 remote-diode temperature exceeds the temperature threshold limit in the Remote 5 $\overline{\text{OVERT}}$ High Limit register.
3	Remote $\overline{\text{OVERT}}$ 4	0	Channel 4 Remote-Diode Overtemperature Status Bit. This bit is set to logic 1 when the channel 4 remote-diode temperature exceeds the temperature threshold limit in the Remote 4 $\overline{\text{OVERT}}$ High Limit register.
2	Remote $\overline{\text{OVERT}}$ 3	0	Channel 3 Remote-Diode Overtemperature Status Bit. This bit is set to logic 1 when the channel 3 remote-diode temperature exceeds the temperature threshold limit in the Remote 3 $\overline{\text{OVERT}}$ High Limit register.
1	Remote $\overline{\text{OVERT}}$ 2	0	Channel 2 Remote-Diode Overtemperature Status Bit. This bit is set to logic 1 when the channel 2 remote-diode temperature exceeds the temperature threshold limit in the Remote 2 $\overline{\text{OVERT}}$ High Limit register.
0	Remote $\overline{\text{OVERT}}$ 1	0	Channel 1 Remote-Diode Overtemperature Status Bit. This bit is set to logic 1 when the channel 1 remote-diode temperature exceeds the temperature threshold limit in the Remote 1 $\overline{\text{OVERT}}$ High Limit register.

表9. 二极管故障状态寄存器(46h)

BIT	NAME	POR STATE	FUNCTION
7 (MSB)	RESERVED	0	—
6	Diode Fault 7	0	Channel 7 Remote-Diode Fault Bit. This bit is set to 1 when DXP7 and DXN7 are open circuit or when DXP7 is connected to V_{CC} .
5	Diode Fault 6	0	Channel 6 Remote-Diode Fault Bit. This bit is set to 1 when DXP6 and DXN6 are open circuit or when DXP6 is connected to V_{CC} .
4	Diode Fault 5	0	Channel 5 Remote-Diode Fault Bit. This bit is set to 1 when DXP5 and DXN5 are open circuit or when DXP5 is connected to V_{CC} .
3	Diode Fault 4	0	Channel 4 Remote-Diode Fault Bit. This bit is set to 1 when DXP4 and DXN4 are open circuit or when DXP4 is connected to V_{CC} .
2	Diode Fault 3	0	Channel 3 Remote-Diode Fault Bit. This bit is set to 1 when DXP3 and DXN3 are open circuit or when DXP3 is connected to V_{CC} .
1	Diode Fault 2	0	Channel 2 Remote-Diode Fault Bit. This bit is set to 1 when DXP2 and DXN2 are open circuit or when DXP2 is connected to V_{CC} .
0	Diode Fault 1	0	Channel 1 Remote-Diode Fault Bit. This bit is set to 1 when DXP1 and DXN1 are open circuit or when DXP1 is connected to V_{CC} .

精度为 $\pm 1^{\circ}\text{C}$ 的8通道温度传感器

表10. $\overline{\text{ALERT}}$ 低温状态寄存器(47h)

BIT	NAME	POR STATE	FUNCTION
7 (MSB)	Remote $\overline{\text{ALERT}}$ Low 7	0	Channel 7 Remote-Diode Low-Alert Bit. This bit is set to logic 1 when the channel 7 remote-diode temperature falls below the programmed temperature threshold limit in the Remote 7 $\overline{\text{ALERT}}$ Low Limit register.
6	Local $\overline{\text{ALERT}}$ Low	0	Local Channel Remote-Diode Low-Alert Bit. This bit is set to logic 1 when the local channel remote-diode temperature falls below the programmed temperature threshold limit in the Local $\overline{\text{ALERT}}$ Low Limit register.
5	Remote $\overline{\text{ALERT}}$ Low 6	0	Channel 6 Remote-Diode Low-Alert Bit. This bit is set to logic 1 when the channel 6 remote-diode temperature falls below the programmed temperature threshold limit in the Remote 6 $\overline{\text{ALERT}}$ Low Limit register.
4	Remote $\overline{\text{ALERT}}$ Low 5	0	Channel 5 Remote-Diode Low-Alert Bit. This bit is set to logic 1 when the channel 5 remote-diode temperature falls below the programmed temperature threshold limit in the Remote 5 $\overline{\text{ALERT}}$ Low Limit register.
3	Remote $\overline{\text{ALERT}}$ Low 4	0	Channel 4 Remote-Diode Low-Alert Bit. This bit is set to logic 1 when the channel 4 remote-diode temperature falls below the programmed temperature threshold limit in the Remote 4 $\overline{\text{ALERT}}$ Low Limit register.
2	Remote $\overline{\text{ALERT}}$ Low 3	0	Channel 3 Remote-Diode Low-Alert Bit. This bit is set to logic 1 when the channel 3 remote-diode temperature falls below the programmed temperature threshold limit in the Remote 3 $\overline{\text{ALERT}}$ Low Limit register.
1	Remote $\overline{\text{ALERT}}$ Low 2	0	Channel 2 Remote-Diode Low-Alert Bit. This bit is set to logic 1 when the channel 2 remote-diode temperature falls below the programmed temperature threshold limit in the Remote 2 $\overline{\text{ALERT}}$ Low Limit register.
0	Remote $\overline{\text{ALERT}}$ Low 1	0	Channel 1 Remote-Diode Low-Alert Bit. This bit is set to logic 1 when the channel 1 remote-diode temperature falls below the programmed temperature threshold limit in the Remote 1 $\overline{\text{ALERT}}$ Low Limit register.

理想因子效应

远端温度测量的准确度取决于远端“二极管”(实际上是晶体管)的理想因子(n)。MAX6581的理想因子默认值为 $n = 1.008$ (通道1-7)。IC衬底上的热敏二极管通常为基极和发射极引出、集电极接地的pnp结(二极管接法)。DXP_ 必须连接至pnp结的阳极(发射极), DXN_ 必须连接至pnp结

的阴极(基极)。如果所采用的温敏晶体管的理想因子不是1.008, 则输出数据将有别于最优理想因子下获得的数据。必要时, 可以通过晶体管理想因子寄存器选择不同的理想因子(参见表11)。理想因子选择寄存器可选择每通道的理想因子为默认的1.008或为晶体管理想因子寄存器中的设置值。

精度为 $\pm 1^{\circ}\text{C}$ 的8通道温度传感器

MAX6581

表11. 晶体管理想因子寄存器

REGISTER	B7	B6	B5	B4	B3	B2	B1	B0	IDEALITY FACTOR	HEX
0x4B	X	X	X	0	0	0	0	0	.999	0x00
	X	X	X	0	0	0	0	1	1.000	0x01
	X	X	X	0	0	0	1	0	1.001	0x02
	X	X	X	0	0	0	1	1	1.002	0x03
	X	X	X	0	0	1	0	0	1.003	0x04
	X	X	X	0	0	1	0	1	1.004	0x05
	X	X	X	0	0	1	1	0	1.005	0x06
	X	X	X	0	0	1	1	1	1.006	0x07
	X	X	X	0	1	0	0	0	1.007	0x08
	X	X	X	0	1	0	0	1	1.008	0x09
	X	X	X	0	1	0	1	0	1.009	0x0A
	X	X	X	0	1	0	1	1	1.010	0x0B
	X	X	X	0	1	1	0	0	1.011	0x0C
	X	X	X	0	1	1	0	1	1.012	0x0D
	X	X	X	0	1	1	1	0	1.013	0x0E
	X	X	X	0	1	1	1	1	1.014	0x0F
	X	X	X	1	0	0	0	0	1.015	0x10
	X	X	X	1	0	0	0	1	1.016	0x11
	X	X	X	1	0	0	1	0	1.017	0x12
	X	X	X	1	0	0	1	1	1.018	0x13
	X	X	X	1	0	1	0	0	1.019	0x14
	X	X	X	1	0	1	0	1	1.020	0x15
	X	X	X	1	0	1	1	0	1.021	0x16
	X	X	X	1	0	1	1	1	1.022	0x17
	X	X	X	1	1	0	0	0	1.023	0x18
	X	X	X	1	1	0	0	1	1.024	0x19
	X	X	X	1	1	0	1	0	1.025	0x1A
	X	X	X	1	1	0	1	1	1.026	0x1B
	X	X	X	1	1	1	0	0	1.027	0x1C
	X	X	X	1	1	1	0	1	1.028	0x1D
	X	X	X	1	1	1	1	0	1.029	0x1E
	X	X	X	1	1	1	1	1	1.030	0x1F

X = 无关。

精度为 $\pm 1^{\circ}\text{C}$ 的8通道温度传感器

串联电阻抵消

有些大功率IC上的热敏二极管具有额外的串联电阻，这会导致传统远端温度传感器的温度测量误差。MAX6581的通道1–7具有串联电阻抵消功能(通过电阻抵消寄存器的第[7:0]位使能)，可抵消二极管串联电阻和内部连接电阻的影响。如果串联电阻大到足以影响通道的测量精度，则将这些位置为1。串联电阻抵消功能会将远端通道的转换时间增大125ms(典型值)。该功能抵消了传感器的大部分电阻以及其它串联电阻(例如导线、接触电阻等)。抵消范围为 0Ω 至 100Ω 。

应用信息

远端二极管选择

MAX6581直接测量CPU或其它具有片上温度检测二极管的管芯温度(参见典型应用电路)，还可以测量分立型连接成二极管的晶体管温度。

分立型远端二极管

当远端检测二极管为分立型晶体管时，其集电极和基极必须连接在一起。表13中列出了适合用于MAX6581的分立型晶体管示例。晶体管必须为具有相对较高正向电压的小信号晶体管，否则就可能超出A/D输入电压范围。最高预期温度下的正向电压在 $10\mu\text{A}$ 时必须大于 0.25V ，并且最低预期温度下的正向电压在 $100\mu\text{A}$ 时必须小于 0.95V 。不能采用大功率晶体管。此外，还要确保基极电阻小于 100Ω 。严格的正向电流增益(例如 $50 < \beta < 150$)指标说明制造商具有良好的工艺控制水平，并且器件的 V_{BE} 特性具有较高的一致性。分立型晶体管制造商通常不说明或保证理想因子。由于高品质分立型晶体管的理想因子都位于相对较窄的范围之内，所以这通常不成问题。在使用各种分立型晶体管时，观察到远端温度读数的波动小于 $\pm 2^{\circ}\text{C}$ 。尽管如此，检查确认任何制造商的不同分立型晶体管是否具有良好温度读数一致性，仍然是一种良好的设计习惯。

表12. 电阻抵消寄存器(4Ah)

BIT	NAME	POR STATE	FUNCTION
7 (MSB)	X	0	—
6	RESISTANCE CANCELLATION 7	0	Channel 7 Resistance Cancellation Enable Bit. Set this bit to logic 1 to enable resistance cancellation. Set this bit to logic 0 to disable resistance cancellation.
5	RESISTANCE CANCELLATION 6	0	Channel 6 Resistance Cancellation Enable Bit. Set this bit to logic 1 to enable resistance cancellation. Set this bit to logic 0 to disable resistance cancellation.
4	RESISTANCE CANCELLATION 5	0	Channel 5 Resistance Cancellation Enable Bit. Set this bit to logic 1 to enable resistance cancellation. Set this bit to logic 0 to disable resistance cancellation.
3	RESISTANCE CANCELLATION 4	0	Channel 4 Resistance Cancellation Enable Bit. Set this bit to logic 1 to enable resistance cancellation. Set this bit to logic 0 to disable resistance cancellation.
2	RESISTANCE CANCELLATION 3	0	Channel 3 Resistance Cancellation Enable Bit. Set this bit to logic 1 to enable resistance cancellation. Set this bit to logic 0 to disable resistance cancellation.
1	RESISTANCE CANCELLATION 2	0	Channel 2 Resistance Cancellation Enable Bit. Set this bit to logic 1 to enable resistance cancellation. Set this bit to logic 0 to disable resistance cancellation.
0	RESISTANCE CANCELLATION 1	0	Channel 1 Resistance Cancellation Enable Bit. Set this bit to logic 1 to enable resistance cancellation. Set this bit to logic 0 to disable resistance cancellation.

X = 无关。

精度为 $\pm 1^{\circ}\text{C}$ 的8通道温度传感器

表13. 远端传感器晶体管供应商(通道1–7)

SUPPLIER	MODEL NO.	
	PNP	NPN
Central Semiconductor Corp. (USA)	CMPT3906 2N3906	CMPT3904 2N3904
Fairchild Semiconductor (USA)	MMBT3906 2N3906	2N3904
Infineon (Germany)	SMBT3906	—
ON Semiconductor (USA)	MMBT3906 2N3906	2N3904
ROHM Semiconductor (USA)	SST3906	SST3904
Samsung (Korea)	KST3906-TF	KST3904-TF
Siemens (Germany)	SMBT3906	SMBT3904
Zetex (England)	FMMT3906CT-ND	FMMT3904CT-ND

注：分立型晶体管必须采用二极管接法(基极短路至集电极)。

未使用的二极管通道

如果不需要使用某个或某些远端二极管通道，可以不连接相应通道的DXP_和DXN_输入，或者将DXP_连接至相应的DXN_。状态寄存器将指示该通道为二极管“故障”，并且在测温顺序中将忽略该通道。最好在上电时通过置位ALERT屏蔽寄存器和OVERT屏蔽寄存器中的相应位将所有未使用的通道屏蔽。这样会防止未使用的通道触发ALERT或OVERT。

散热和自发热

测量本地温度时，MAX6581测量其所在的PCB温度。引脚为PCB走线和管芯之间提供了良好的散热通路。和所有IC温度传感器一样，管芯和环境空气之间的导热性相对较差，从而导致测量空气温度不太准确。由于PCB的散热能力远远大于MAX6581，所以器件温度将随PCB的温度变化，具有很小或不可察觉的延迟。在测量CPU或其它具有片上测量结的IC温度时，散热基本上没有影响。测得的结温在一个转换周期内跟随实际温度变化。当使用分立型远端晶体管测量温度时，采用小封装(即SOT23或SC70封装)的晶体管可获得最佳的热响应时间。要严格考虑热源和传感器之间的热梯

度，并确保传感器封装两端的杂散气流不会干扰测量准确度。自发热不会明显影响测量准确度。由二极管电流源引起的远端传感器自发热可忽略不计。

ADC噪声滤波

内置的ADC对于低频信号(例如电源杂音)具有良好的噪声抑制特性。在具有较大高频EMI的环境下，DXP_和DXN_之间应跨接100pF的外部电容。为提高滤波效果，可使用较大的电容值，然而电流源切换的上升时间会引起误差。对于高精度远端测量来说，需要进行高频噪声抑制。如PCB布局部分所述，设计合理的PCB可降低噪声。

从地址

MAX6581的从地址请参见表14。

表14. 从地址

DEVICE ADDRESS							
A7	A6	A5	A4	A3	A2	A1	A0
1	0	0	1	1	0	1	R/W

精度为 $\pm 1^{\circ}\text{C}$ 的8通道温度传感器



图5. 推荐的DXP_至DXN_ PCB走线, 如果在DXN_和DXP_走线附近有高压走线, 建议采用两个外部保护带

PCB布局

遵守以下规则可降低测量远端温度时的测量误差:

- 1) 将MAX6581尽量靠近远端二极管放置。在嘈杂的环境下, 例如计算机主板, 该距离通常可为4英寸至8英寸。如果能够避开严重的噪声源, 可延长该距离。噪声源包括显示器、时钟发生器、存储总线及PCI总线。
- 2) 请勿使DXP_至DXN_连接线靠近CRT的偏转线圈。此外, 请勿使走线与快速变化的数字信号交叉, 否则即使采取很好的滤波措施, 也会很容易引起 $+30^{\circ}\text{C}$ 的误差。
- 3) 使DXP_和DXN_走线保持平行并尽量靠近。应该用每对平行的走线连接一个远端二极管。使这些走线远离高压走线, 例如 $+12\text{V}$ 直流。由于DXP_和地之间 $20\text{M}\Omega$ 的泄漏通路即可引起大约 $+1^{\circ}\text{C}$ 的误差, 所以必须严格处理PCB污染引起的漏流。如果不可避免使用高压走线, 请将DXP_至DXN_引线两侧的保护带连接到GND(图5)。
- 4) 尽量避免过孔和穿交, 使铜/焊接热电偶效应达到最小。
- 5) 如可能, 采用宽走线(典型值为5mil至10mil)。在使用细长的走线时, 要了解走线电阻对温度读数的影响。
- 6) 当电源噪声较大时, 在 V_{CC} 上增加一个串联电阻(最大 47Ω)。

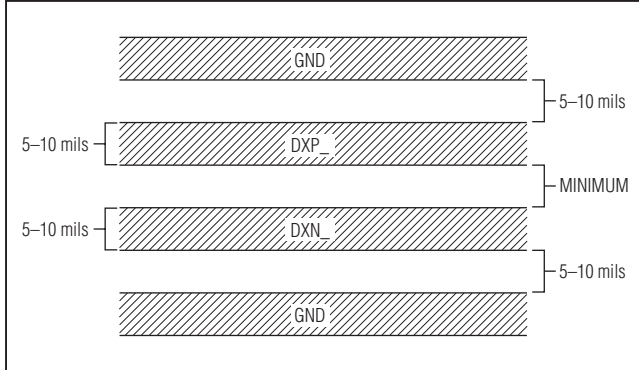
双绞线和屏蔽电缆

当远端传感器距离大于8英寸, 或者在非常嘈杂的环境下时, 应利用双绞线电缆连接远端传感器。双绞线电缆的长度可为6英尺至12英尺, 再长可能会引起严重的误差。对于更长的距离, 最好的解决方案是采用屏蔽双绞线, 像音频麦克风用到的屏蔽双绞线。例如, Belden #8451在嘈杂环境下的工作距离可达100英尺。在器件端, 将双绞线电缆连接到DXP_和DXN_, 将屏蔽层连接到GND。在远端传感器处, 使屏蔽层保持不连接状态。对于非常长的电缆, 电缆的寄生电容往往具备了噪声滤波的功能, 所以通常可拆去 100pF 的电容, 或者减小电容值。电缆电阻也会影响远端传感器的精度。每 1Ω 的串联电阻会引起大约 $+0.5^{\circ}\text{C}$ 的误差。

精度为 $\pm 1^{\circ}\text{C}$ 的8通道温度传感器

典型应用电路

MAX6581

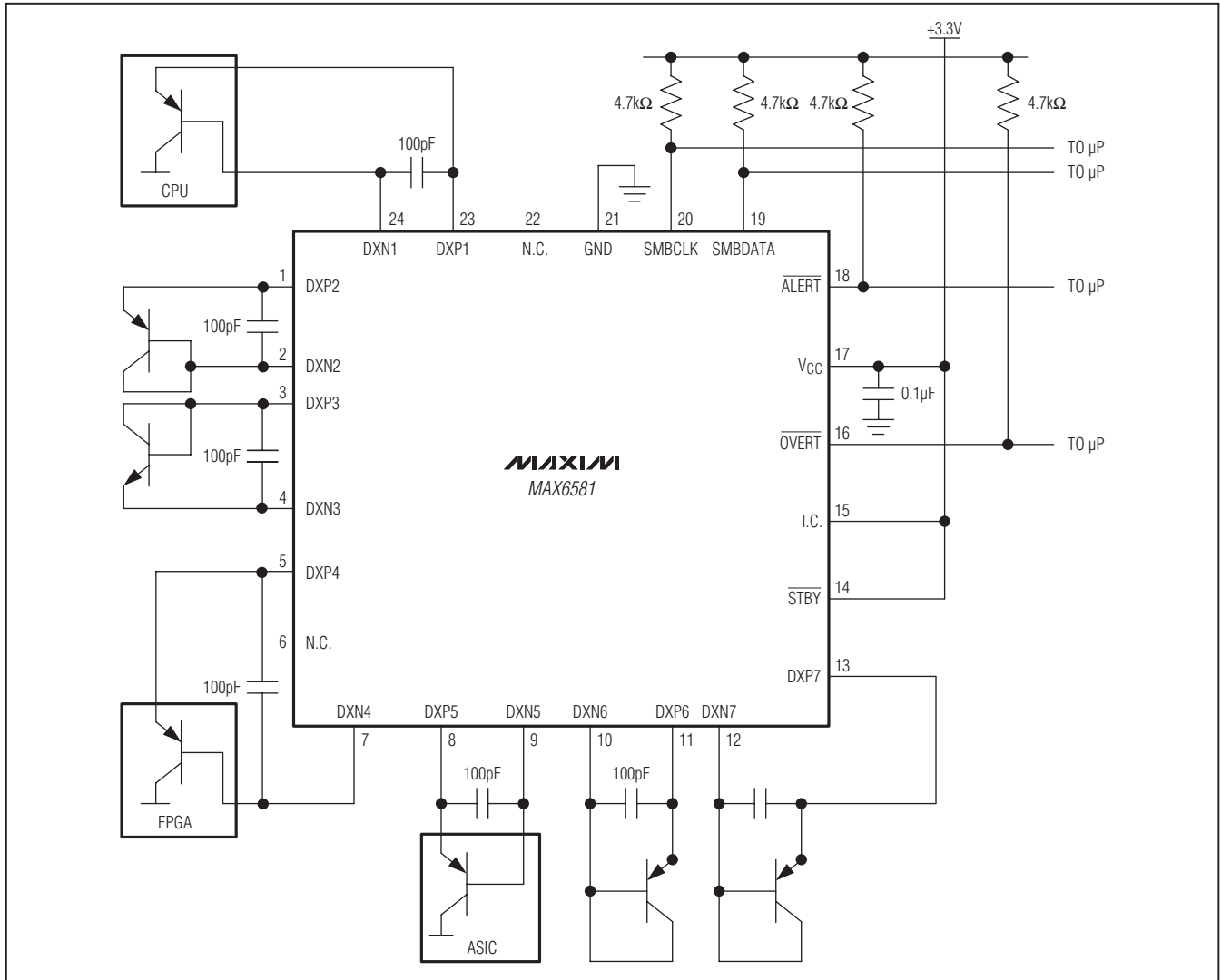

芯片信息

封装信息

PROCESS: BiCMOS

如需最近的封装外形信息和焊盘布局，请查询china.maxim-ic.com/packages。请注意，封装编码中的“+”、“#”或“-”仅表示RoHS状态。封装图中可能包含不同的尾缀字符，但封装图只与封装有关，与RoHS状态无关。

封装类型	封装编码	外形编号	焊盘布局编号
24 TQFN-EP	T2444+4	21-0139	90-0022

精度为 $\pm 1^{\circ}\text{C}$ 的8通道温度传感器

修订历史

修订号	修订日期	说明	修改页
0	8/10	最初版本。	—

Maxim北京办事处

北京8328信箱 邮政编码 100083

免费电话: 800 810 0310

电话: 010-6211 5199

传真: 010-6211 5299

Maxim不对Maxim产品以外的任何电路使用负责, 也不提供其专利许可。Maxim保留在任何时间、没有任何通报的前提下修改产品资料和规格的权利。

24 **Maxim Integrated Products, 120 San Gabriel Drive, Sunnyvale, CA 94086 408-737-7600**

© 2010 Maxim Integrated Products

Maxim是Maxim Integrated Products, Inc.的注册商标。