

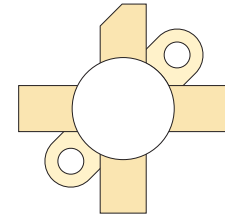

RF POWER VERTICAL MOSFET

The VRF141 is a gold-metallized silicon n-channel RF power transistor designed for broadband commercial and military applications requiring high power and gain without compromising reliability, ruggedness, or inter-modulation distortion.



FEATURES

- Improved Ruggedness $V_{(BR)DSS} = 80\text{ V}$
- 150W with 22dB Typical Gain @ 30MHz, 28V
- 150W with 13dB Typical Gain @ 175MHz, 28V
- Excellent Stability & Low IMD
- Common Source Configuration
- Available in Matched Pairs
- 30:1 Load VSWR Capability at Specified Operating Conditions
- Nitride Passivated
- Refractory Gold Metallization
- High Voltage Replacement for MRF141
- RoHS Compliant 

Maximum Ratings

All Ratings: $T_c = 25^\circ\text{C}$ unless otherwise specified

Symbol	Parameter	VRF141(MP)	Unit
V_{DSS}	Drain-Source Voltage	80	V
I_D	Continuous Drain Current @ $T_c = 25^\circ\text{C}$	20	A
V_{GS}	Gate-Source Voltage	± 40	V
P_D	Total Device dissipation @ $T_c = 25^\circ\text{C}$	300	W
T_{STG}	Storage Temperature Range	-65 to 150	°C
T_J	Operating Junction Temperature	200	

Static Electrical Characteristics

Symbol	Parameter	Min	Typ	Max	Unit
$V_{(BR)DSS}$	Drain-Source Breakdown Voltage ($V_{GS} = 0\text{V}$, $I_D = 100\text{mA}$)	80			V
$V_{DS(ON)}$	On State Drain Voltage ($I_{D(ON)} = 10\text{A}$, $V_{GS} = 10\text{V}$)		0.9	1.0	
I_{DSS}	Zero Gate Voltage Drain Current ($V_{DS} = 60\text{V}$, $V_{GS} = 0\text{V}$)			1.0	mA
I_{GSS}	Gate-Source Leakage Current ($V_{DS} = \pm 20\text{V}$, $V_{GS} = 0\text{V}$)			1.0	μA
g_{fs}	Forward Transconductance ($V_{DS} = 10\text{V}$, $I_D = 5\text{A}$)	5.0			mhos
$V_{GS(TH)}$	Gate Threshold Voltage ($V_{DS} = 10\text{V}$, $I_D = 100\text{mA}$)	2.9	3.6	4.4	V

Thermal Characteristics

Symbol	Characteristic	Min	Typ	Max	Unit
$R_{\theta JC}$	Junction to Case Thermal Resistance			0.60	°C/W

Dynamic Characteristics

Symbol	Parameter	Test Conditions	Min	Typ	Max	Unit
C_{ISS}	Input Capacitance	$V_{GS} = 0\text{V}$		400		pF
C_{OSS}	Output Capacitance	$V_{DS} = 28\text{V}$		375		
C_{RSS}	Reverse Transfer Capacitance	$f = 1\text{MHz}$		50		

 **CAUTION:** These Devices are Sensitive to Electrostatic Discharge. Proper Handling Procedures Should Be Followed.

Functional Characteristics

Symbol	Parameter	Min	Typ	Max	Unit
G_{PS}	$f_1 = 30\text{MHz}, f_2 = 30.001\text{MHz}, V_{DD} = 28\text{V}, I_{DQ} = 250\text{mA}, P_{out} = 150\text{W}_{PEP}$	16	20		dB
G_{PS}	$f_1 = 175\text{MHz}, V_{DD} = 28\text{V}, I_{DQ} = 250\text{mA}, P_{out} = 150\text{W}$		13		
η	$f_1 = 30\text{MHz}, f_2 = 30.001\text{MHz}, V_{DD} = 28\text{V}, I_{DQ} = 250\text{mA}, P_{out} = 150\text{W}_{PEP}$	40	45		%
$IMD_{(d3)}$	$f_1 = 30\text{MHz}, f_2 = 30.001\text{MHz}, V_{DD} = 28\text{V}, I_{DQ} = 250\text{mA}, P_{out} = 150\text{W}_{PEP}$ ¹		-30	-28	dB
$IMD_{(d11)}$	$f_1 = 30\text{MHz}, f_2 = 30.001\text{MHz}, V_{DD} = 28\text{V}, I_{DQ} = 250\text{mA}, P_{out} = 150\text{W}_{PEP}$		-60		
ψ	$f_1 = 30\text{MHz}, f_2 = 30.001\text{MHz}, V_{DD} = 28\text{V}, I_{DQ} = 250\text{mA}, P_{out} = 150\text{W}_{PEP}$ 30:1 VSWR - All Phase Angles	No Degradation in Output Power			

Class A Characteristics

Symbol	Test Conditions	Min	Typ	Max	Unit
G_{PS}	$f_1 = 30\text{MHz}, f_2 = 30.001\text{MHz}, V_{DD} = 28\text{V}, I_{DQ} = 4.0\text{A}, P_{out} = 50\text{W}_{PEP}$		23		dB
$IMD_{(d3)}$	$f_1 = 30\text{MHz}, f_2 = 30.001\text{MHz}, V_{DD} = 28\text{V}, I_{DQ} = 4.0\text{A}, P_{out} = 50\text{W}_{PEP}$		-50		
$IMD_{(d9-d13)}$	$f_1 = 30\text{MHz}, f_2 = 30.001\text{MHz}, V_{DD} = 28\text{V}, I_{DQ} = 4.0\text{A}, P_{out} = 50\text{W}_{PEP}$		-75		

1. To MIL-STD-1311 Version A, test method 2204B, Two Tone, Reference Each Tone

Microsemi reserves the right to change, without notice, the specifications and information contained herein.

Typical Performance Curves

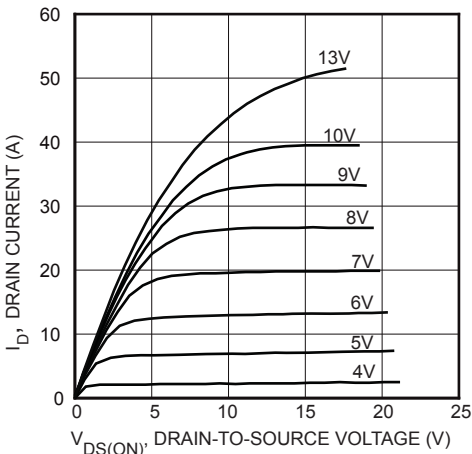

FIGURE 1, Output Characteristics

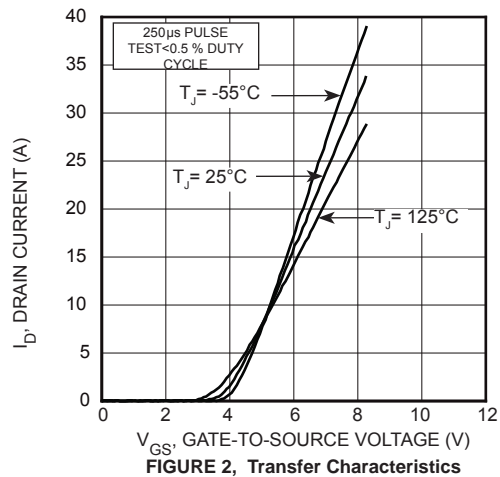

FIGURE 2, Transfer Characteristics

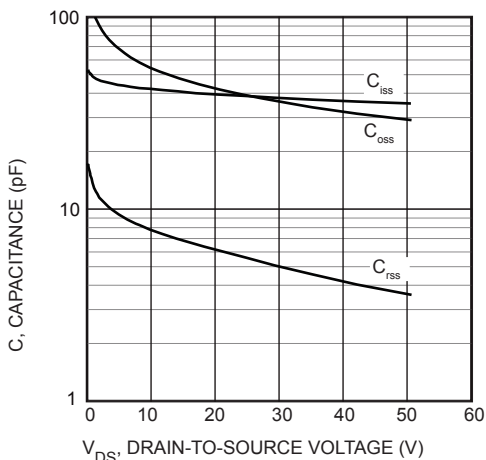

FIGURE 3, Capacitance vs Drain-to-Source Voltage

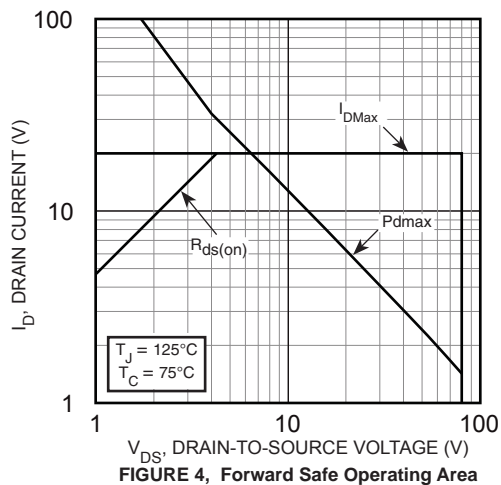
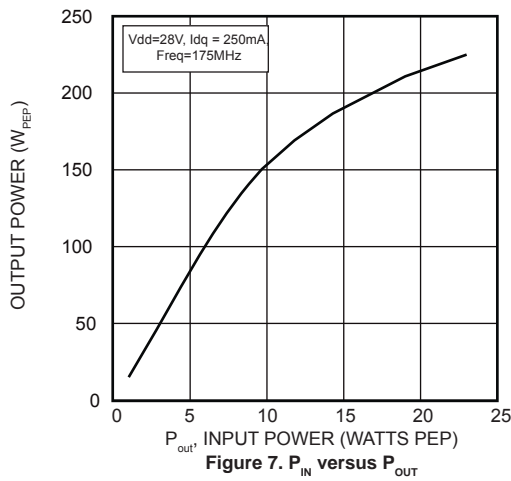
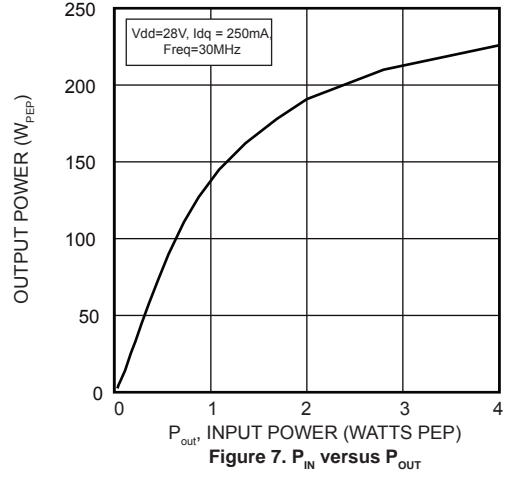
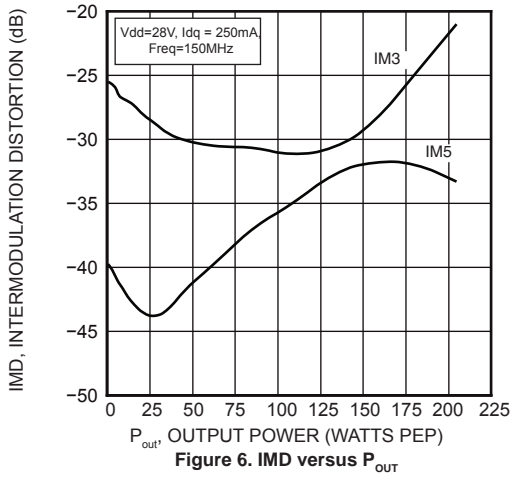
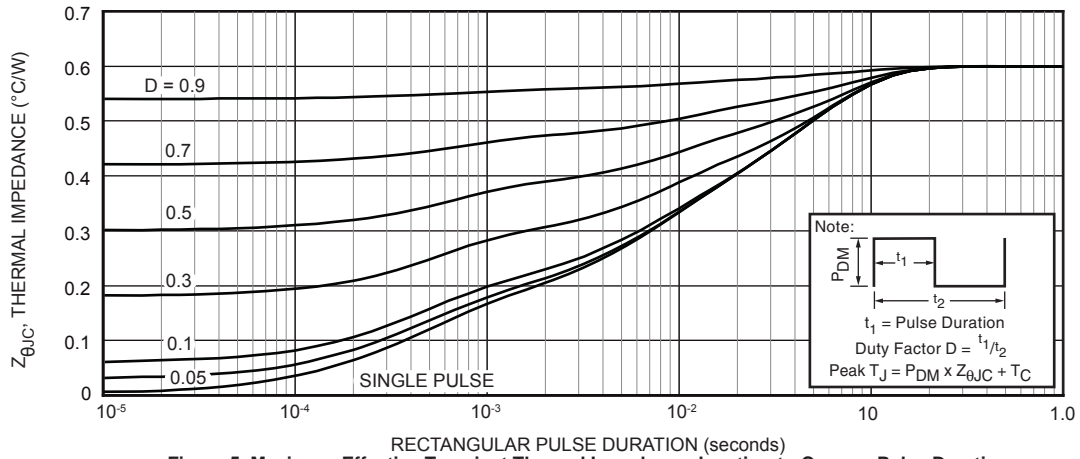
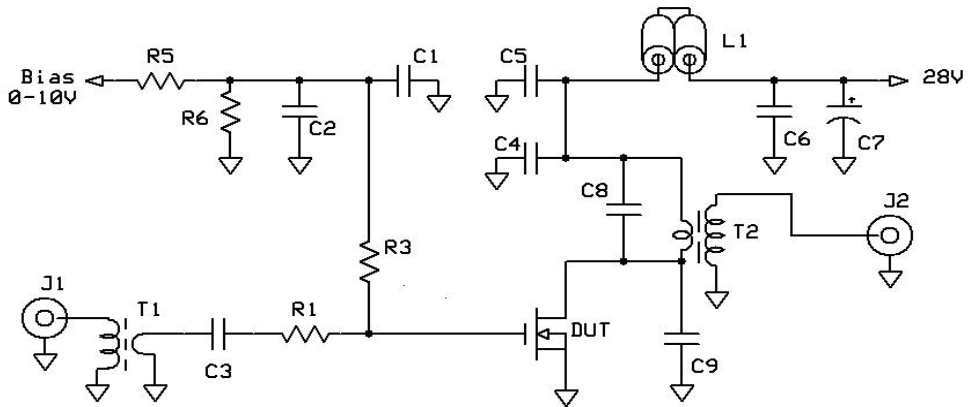

FIGURE 4, Forward Safe Operating Area



30 MHz test Circuit



- | | |
|---|-------------------------------|
| C1 - 1uF 50V tantalum | C9 - 100 pF ATC 100B |
| C2-C6 - 0.1uF 100V SMT | L1 - two ferrite beads on #18 |
| C7 - 15uF 100V Elect | R1 - 1 ohm 1 W SMT |
| C8 - 820 pF ATC 100B | R3 - 200 ohm 1/2 Carbn |
| T1 - 16:1 bead/tube transformer | R4 - 470 ohm 1W |
| T2 = 1:25 broadband bead/tube transformer u=125 | R5 R6 - 2200 ohm 1/4W |

175 MHz test Circuit

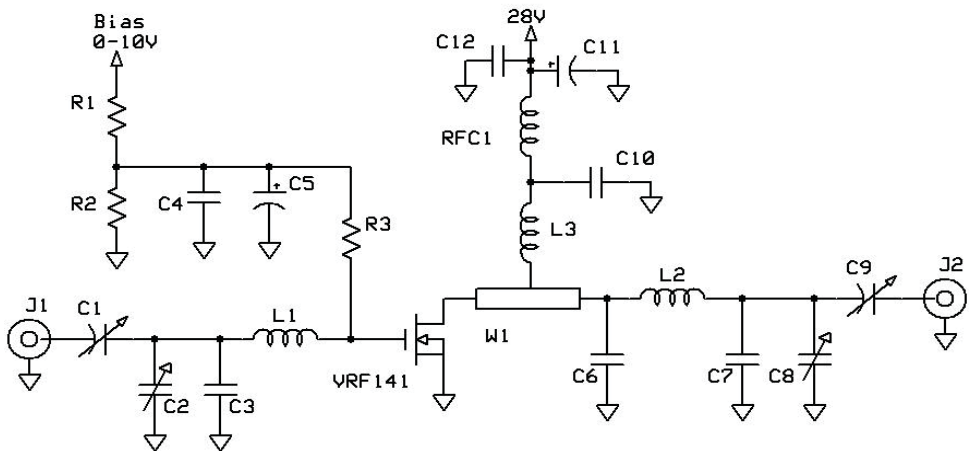

- | | |
|-----------------------------|---|
| C1, 2, 8, 9 - ARCO 463 | L1 - 3/4" #18 ga into Hairpin |
| C3 C7 - 25 pF ATC 100B | W1 - printed line 0.23"W x 0.7" L |
| C4 C10 C12 - 0.1uF 100V SMT | L2 - 2t #16 ga .25" dia x .25" ~ 35nH |
| C5 - 1 uF 15WV tant | L3 -2 turns #16 ga 5/16" ID tight. ~ 50nH |
| C6 - 270 pF ATC 100B | R1 R2 - 2.2k ohm 1/4W |
| C10 - .05 100V 1206 SMT | R3 - 150 ohm 1/4W |
| C11 - 15uF 100V Elect | RFC1 Fair-Rite 2961666631 (VK200-4B) |

Adding MP at the end of P/N specifies a matched pair where $V_{GS(TH)}$ is matched between the two parts. V_{TH} values are marked on the devices per the following table.

Code	Vth Range	Code 2	Vth Range
A	2.900 - 2.975	M	3.650 - 3.725
B	2.975 - 3.050	N	3.725 - 3.800
C	3.050 - 3.125	P	3.800 - 3.875
D	3.125 - 3.200	R	3.875 - 3.950
E	3.200 - 3.275	S	3.950 - 4.025
F	3.275 - 3.350	T	4.025 - 4.100
G	3.350 - 3.425	W	4.100 - 4.175
H	3.425 - 3.500	X	4.175 - 4.250
J	3.500 - 3.575	Y	4.250 - 4.325
K	3.575 - 3.650	Z	4.325 - 4.400

V_{TH} values are based on Microsemi measurements at datasheet conditions with an accuracy of 1.0%.

M174 Package Outline .5" SOE
All Dimensions to be ±.005"

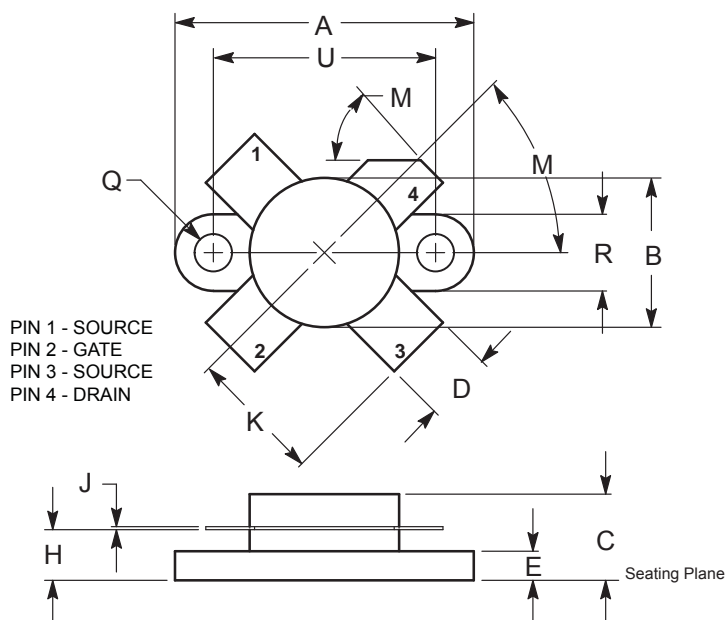

DIM	INCHES		MILLIMETERS	
	MIN	MAX	MIN	MAX
A	0.096	0.990	24.39	25.14
B	0.465	0.510	11.82	12.95
C	0.229	0.275	5.82	6.98
D	0.216	0.235	5.49	5.96
E	0.084	0.110	2.14	2.79
H	0.144	0.178	3.66	4.52
J	0.003	0.007	0.08	0.17
K	0.435		11.0	
M	45° NOM		45° NOM	
Q	0.115	0.130	2.93	3.30
R	0.246	0.255	6.25	6.47
U	0.720	0.730	18.29	18.54

Microsemi's products are covered by one or more of U.S. patents 4,895,810 5,045,903 5,089,434 5,182,234 5,019,522 5,262,336 6,503,786 5,256,583 4,748,103 5,283,202 5,231,474 5,434,095 5,528,058 6,939,743, 7,352,045 5,283,201 5,801,417 5,648,283 7,196,634 6,664,594 7,157,886 6,939,743 7,342,262 and foreign patents. US and Foreign patents pending. All Rights Reserved.