

DC-DC Converter (-30V, -2.5A)

RSQ025P03

●Features

- 1) Low On-resistance.(120mΩ at 4.5V)
- 2) High Power Package.(Pd=1.25W)
- 3) High speed switching.
- 4) Low voltage drive.(4V)

●Applications

DC-DC converter

●Structure

Silicon P-channel
MOSFET

●Packaging specifications

Type	Package	Taping
	Code	TR
	Basic ordering unit (pieces)	3000
RSQ025P03		○

●External dimensions (Units : mm)

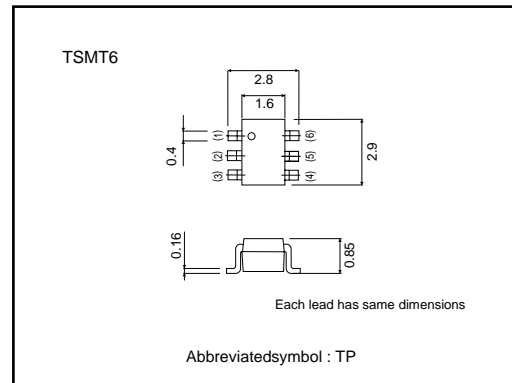

●Equivalent circuit

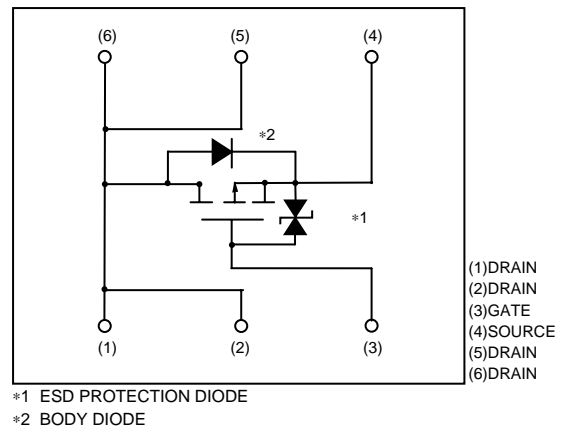

Transistor

● Absolute maximum ratings (Ta=25°C)

Parameter	Symbol	Limits	Unit
Drain-source voltage	V _{DSS}	-30	V
Gate-source voltage	V _{GSS}	±20	V
Drain current	Continuous	I _D	±2.5
	Pulsed	I _{DP}	±10
Source current (Body diode)	Continuous	I _S	-1
	Pulsed	I _{SP}	-4
Total power dissipation	P _D	1.25	W ^{*2}
Channel temperature	T _{ch}	150	°C
Range of Storage temperature	T _{stg}	-55~+150	°C

*1 Pw≤10μs, Duty cycle≤1%

*2 Mounted on a ceramic board

● Electrical characteristics (Ta=25°C)

Parameter	Symbol	Min.	Typ.	Max.	Unit	Conditions
Gate-source leakage	I _{GSS}	-	-	±10	μA	V _{GS} =±20V, V _{DS} =0V
Drain-source breakdown voltage	V _{(BR)DSS}	-30	-	-	V	I _D =-1mA, V _{GS} =0V
Zero gate voltage drain current	I _{DSS}	-	-	-1	μA	V _{DS} =-30V, V _{GS} =0V
Gate threshold voltage	V _{GS(th)}	-1.0	-	-2.5	V	V _{DS} =-10V, I _D =-1mA
Static drain-source on-state resistance	R _{DS(on)} [*]	-	80	110	mΩ	I _D =-2.5A, V _{GS} =-10V
		-	120	165	mΩ	I _D =-1.25A, V _{GS} =-4.5V
		-	145	200	mΩ	I _D =-1.25A, V _{GS} =-4.0V
Forward transfer admittance	Y _{fs} [*]	1.2	-	-	S	V _{DS} =-10V, I _D =-1.25A
Input capacitance	C _{iss}	-	320	-	pF	V _{DS} =-10V, V _{GS} =0V f=1MHz
Output capacitance	C _{oss}	-	85	-	pF	
Reverse transfer capacitance	C _{rss}	-	60	-	pF	
Turn-on delay time	t _{d(on)} [*]	-	8	-	ns	I _D =-1.25A V _{DD} =-15V V _{GS} =-4.5V R _L =12Ω R _{GS} =10Ω
Rise time	t _r [*]	-	11	-	ns	
Turn-off delay time	t _{d(off)} [*]	-	33	-	ns	
Fall time	t _f [*]	-	7	-	ns	
Total gate charge	Q _g	-	4.4	-	nC	V _{DD} =-15V V _{GS} =-5V I _D =-2.5A
Gate-source charge	Q _{gs}	-	1.0	-	nC	
Gate-drain charge	Q _{gd}	-	1.4	-	nC	

*PULSED

Body diode characteristics (source-drain characteristics)

Forward voltage	V _{SD}	-	-	-1.2	V	I _S =-0.9A, V _{GS} =0V
-----------------	-----------------	---	---	------	---	--

Transistor

●Electrical characteristic curves

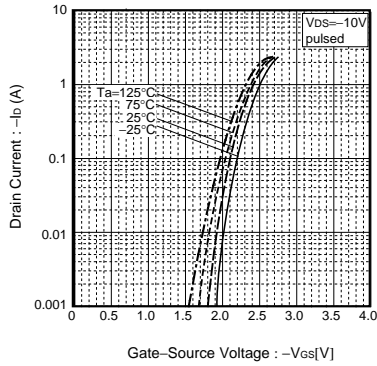

Fig.1 Typical Transfer Characteristics

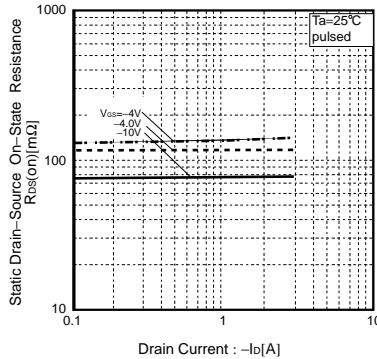

Fig.2 Static Drain-Source On-State Resistance vs. Drain Current

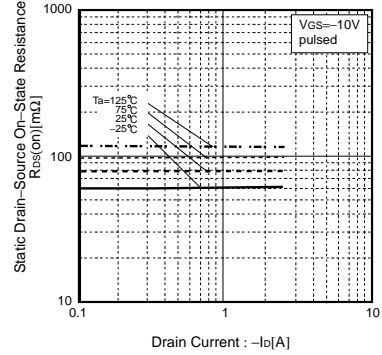

Fig.3 Static Drain-Source On-State Resistance vs. Drain Current

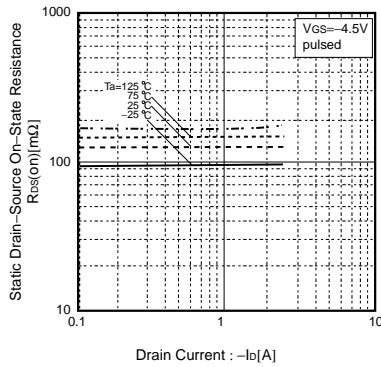

Fig.4 Static Drain-Source On-State Resistance vs. Drain-Current

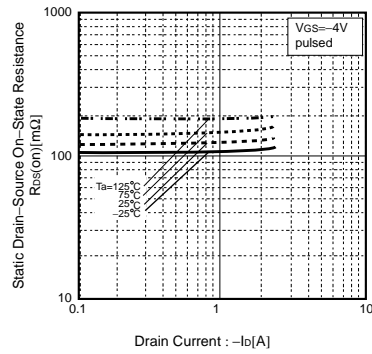

Fig.5 Static Drain-Source On-State Resistance vs. Drain-Current

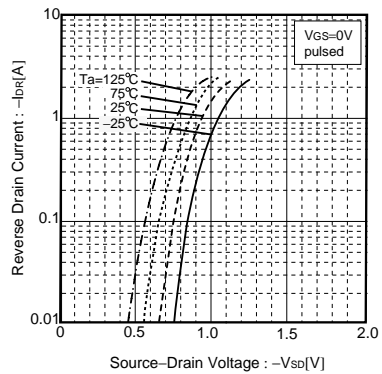

Fig.6 Reverse Drain Current Source-Drain Voltage

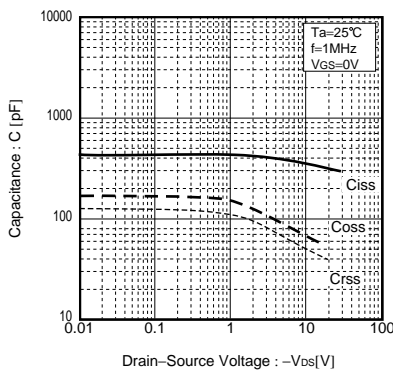

Fig.7 Typical Capacitance vs. Drain-Source Voltage

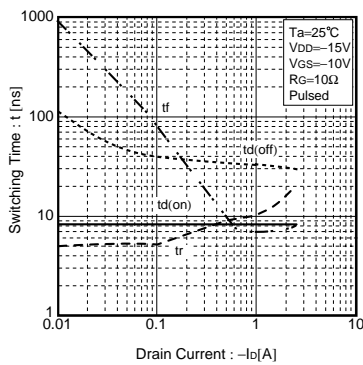

Fig.8 Switching Characteristics

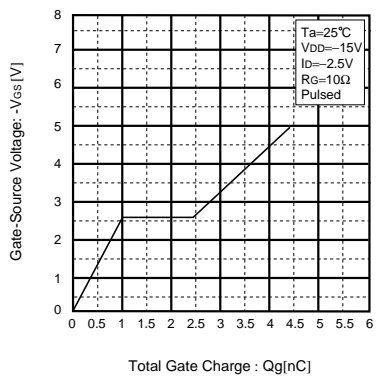

Fig.9 Dynamic Input Characteristics

Transistor

● Measurement circuits

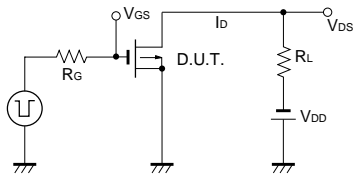

Fig.10 Switching Time Measurement Circuit

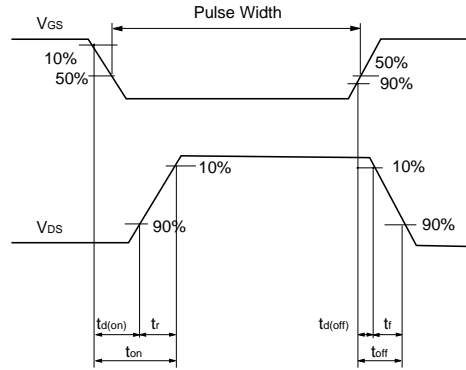

Fig.11 Switching Waveforms

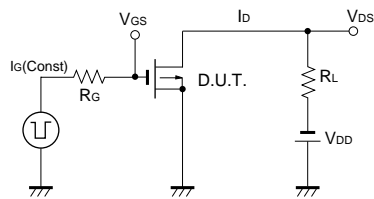

Fig.12 Gate Charge Measurement Circuit

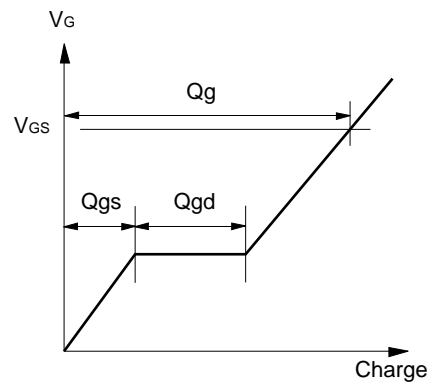

Fig.13 Gate Charge Waveforms