

MEMBRANE TYPE PRESSURE INDICATOR

DATA SHEET

PCJ

This instrument is designed to directly accept a very small pressure from a furnace, etc. to indicate the pressure as a membrane displacement.

FEATURES

1. Measures a very small pressure with strict accuracy.
2. Simple operating principle and construction assures easy handling, maintenance and inspection.
3. Compact and light-weight design, yet provides space for installation of alarm unit.

SPECIFICATIONS

Input (standard scale):

0 to 30, 50, 100, 150, 200, 250, 300, 400, 500, 1000, 1500, 2000,
-30 to 0, -50 to 0, -100 to 0,
-150 to 0, -200 to 0, -250 to 0,
-300 to 0, -400 to 0, -500 to 0,
-15 to +15, -30 to +30, -50 to +50,
-75 to +75, -100 to +100, -150 to +150,
-200 to +200, -250 to +250,
-20 to +30, -20 to +80, -50 to +150,
-100 to +200, -200 to +600, -500 to +1000mmH₂O.

Allowance: ±1.0 % of full scale (with material B)
±1.5 % of full scale (with material S)

Scale length: 90 mm

Reproducibility: ±0.5 % of full scale

Sensitivity: 0.3 % input of full scale

Allowable overpressure:

1.3 times the maximum input pressure

Material (as specified):

B: Membrane (phosphor bronze), cock (bronze), pipe (copper)

S: Membrane (SUS304), cock (SUS304), pipe (SUS304)

Ambient temperature:

0 to 50°C

Ambient humidity: Less than 90 % RH

Conduit connection:

PT 1/4 internal thread and vinyl (rubber) tube coupling nipple (nipple supplied)

Weight: Approx. 2.5 kg (approx. 3 kg with alarm unit)

Dimensions (H x W x D):

80 x 160 x 355 mm

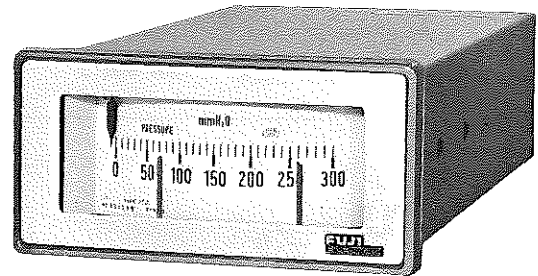

Finish color: Munsell N 1.5 (case and front frame)

Note) Scale entry is as follows.

• Horizontal type:

low pressure at left, high pressure at right

Horizontal type

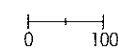

• Vertical type:

low pressure at bottom, high pressure at top

Vertical type

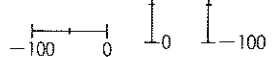

Alarm unit (option):

Upper limit, lower limit or upper/lower limit excited alarm, on-alarm (output relay excited at alarm)

Setting system;

Alarm setting pointer on dial scale

Output contact;

1a contact each

Contact capacity;

AC 100V, 0.3A/DC 24V, 0.2A (resistive load)

Alarm power supply (as specified);

AC 100V ±10 %, 50/60 Hz or

AC 24V ±10%, 50/60 Hz

Power consumption;

Approx. 2 VA

Range of delivery:

Pressure indicator, mounting bracket, 3-way cock, coupling nipple

Mounting method:

Panel flush mounting, horizontal or vertical mounting as specified

(several instruments can be mounted closely together when mounted vertically)

For inclined mounting, specify the angle.

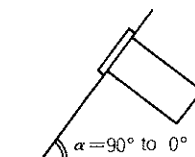

BASIC PRINCIPLE DIAGRAM

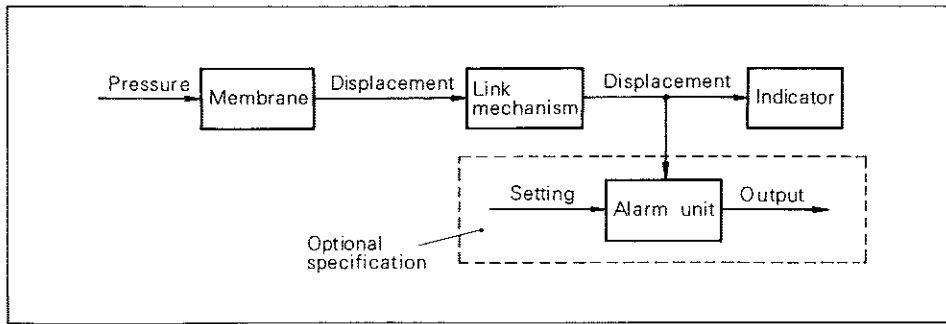

CODE SYMBOLS

1	2	3	4	5	6	7	8	9	10	Description
P	C	J					2			Measuring range (unit: mmH ₂ O) See the code table at right
										Material
						B				Membrane (phosphor bronze), cock (bronze), pipe (copper)
						S				Membrane (SUS304), cock(SUS304), pipe (SUS304)
										Alarm unit
						H				Upper limit
						L				Lower limit
						K				Upper/lower limit
						Y				None
										Mounting method
								1		Horizontal mounting
								2		Vertical mounting
										Alarm unit power supply
								0		None
								* 1		AC 24V 50/60 Hz
								3		AC 100V 50/60 Hz

Code of measuring range (4th, 5th digits)
(unit: mmH₂O)

5th digit	4th digit	4th digit symbol			
		1	2	3	4
5th digit symbol	A	0 to 30	-30 to 0	-15 to +15	
	B	0 to 50	-50 to 0		-20 to +30
	C			-30 to +30	
	D	0 to 100	-100 to 0	-50 to +50	-20 to +80
	E	0 to 150	-150 to 0	-75 to +75	
	F	0 to 200	-200 to 0	-100 to +100	-50 to +150
	G	0 to 250	-250 to 0		
	H	0 to 300	-300 to 0	-150 to +150	-100 to +200
	J	0 to 400	-400 to 0	-200 to +200	
	K	0 to 500	-500 to 0	-250 to +250	
	L				-200 to +600
	M	0 to 1000			
	N	0 to 1500			-500 to +1000
	P	0 to 2000			

Note 1) When the membrane material is SUS304, the 5th digit codes A-C are not available.

Note 2) Measuring range codes other than listed above are ZZ.

In this case, the following measuring ranges are available.

When the minimum span within the range of -10,000 to +10,000 is;

Material B More than 30 mmH₂O

Material S More than 100 mmH₂O

The intermediate measuring range is not available.

(Example; 10 to 1,000 mmH₂O,
-1000 to -500 mmH₂O, etc.)

OUTLINE DIAGRAM (Unit: mm)

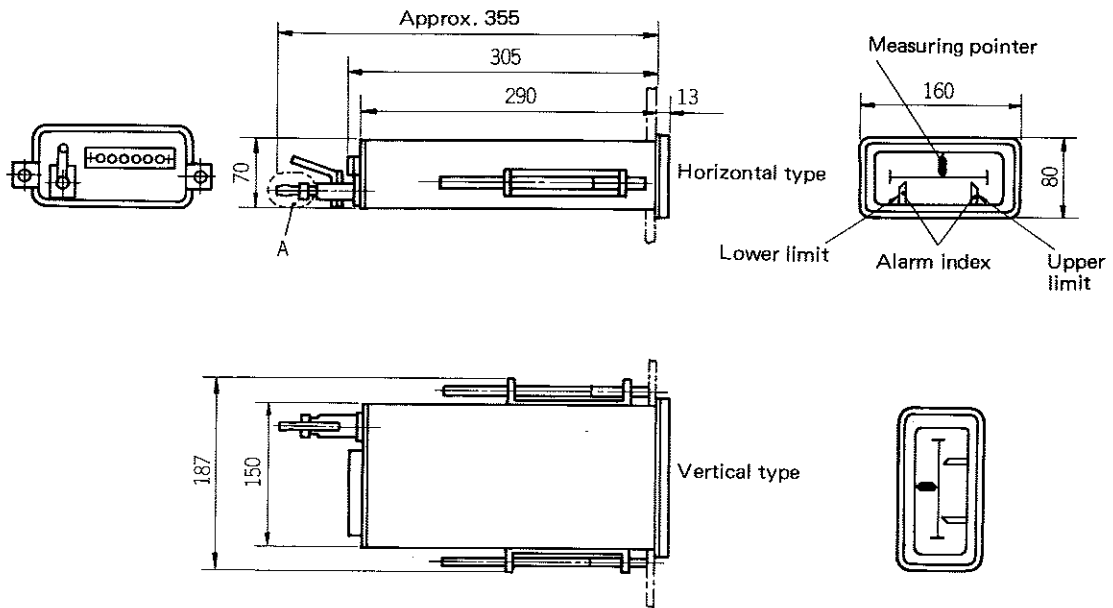

Detail A

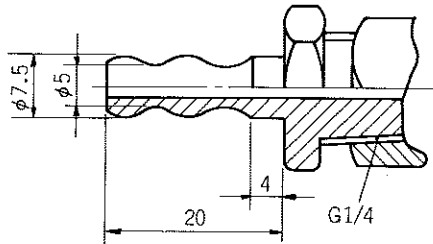

Panel Cutout Dimensions

Horizontal mounting

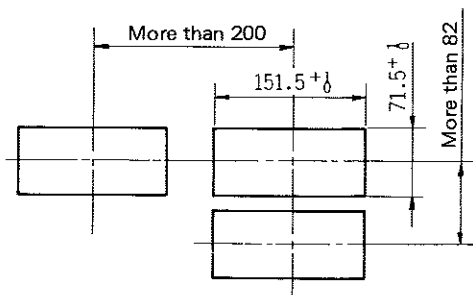

Vertical mounting

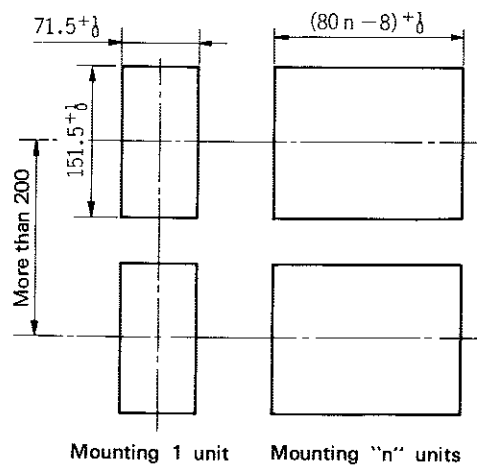

CONNECTION DIAGRAM

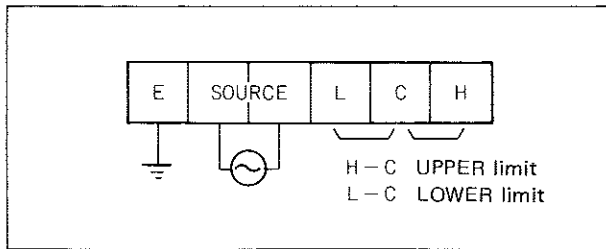

Note) When the pointer goes over the upper limit
H-C is "ON"
When the pointer goes over the lower limit
L-C is "ON"

ORDERING INFORMATION

1. Name of product
2. Code symbols
3. Measuring range
4. Mounting method
5. Material
6. Alarm unit (with or without)
7. Other

• Asterisked (*) items: Non-standard.

Fuji Electric Co.,Ltd.

12-1 Yurakucho 1-chome, Chiyoda-ku, Tokyo, 100 Japan
Phone: Tokyo 3211-7111
Telex: J22331 FUJIELEA or FUJIELEB