

DETAIL "2"

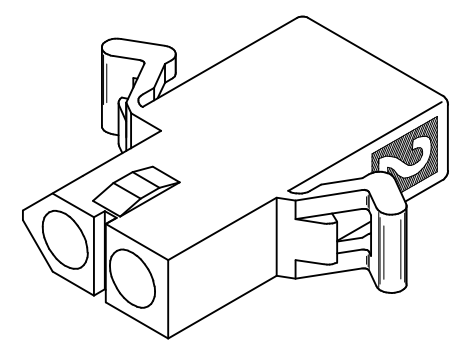
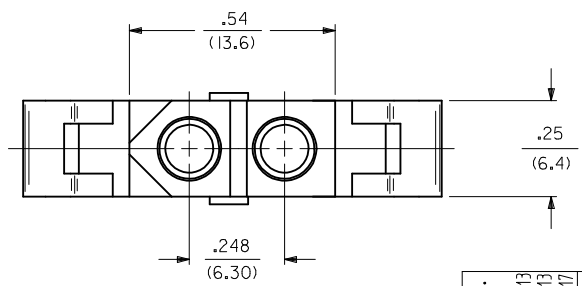
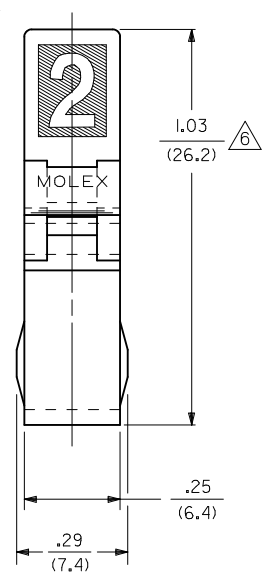
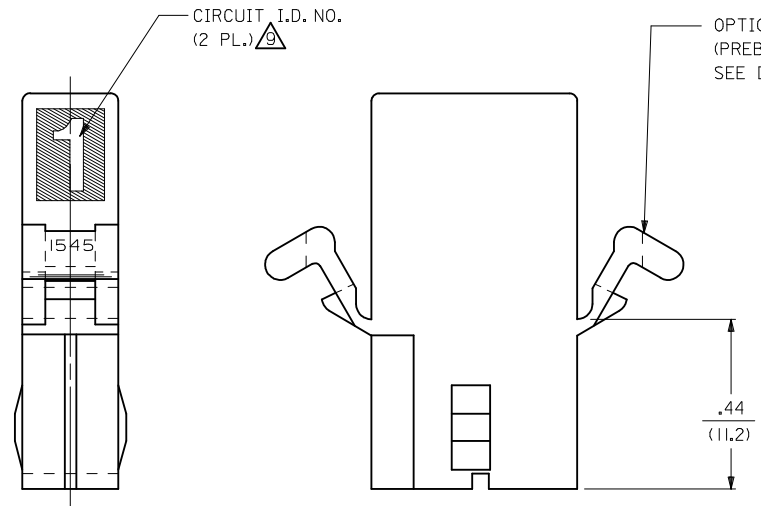

RECEPTACLE

UPDATED NOTE REF. EC NO: UCP2006-2303 DRW:PRI/DDR 2006/04/13 CHKD:AE/HAG 2006/04/13 APPR:FSM/LTH 2006/04/17	QUALITY SYMBOLS ▽=0 ▽=0	GENERAL TOLERANCES (UNLESS SPECIFIED)		DIMENSION STYLE IN/MM	SCALE 4:1	DESIGN UNITS INCH	THIRD ANGLE PROJECTION	
		4 PLACES ± --- ± ---	3 PLACES ± --- ± .010	DRAWN BY GEP	DATE 8/9/88	TITLE .093 DIA. HOUSING PLUG & RECEPTACLE 2 CKT., .248/(6.30) CTR.		
		2 PLACES ± 0.25 ± .014	1 PLACE ± 0.35 ± ---	CHECKED BY RW	DATE 8/9/88	MOLEX INCORPORATED		
		ANGULAR ± 1°		APPROVED BY RAS	DATE 8/9/88	MATERIAL NO. SEE CHART		
DRAFT WHERE APPLICABLE MUST REMAIN WITHIN DIMENSIONS	SIZE C	THIS DRAWING CONTAINS INFORMATION THAT IS PROPRIETARY TO MOLEX INCORPORATED AND SHOULD NOT BE USED WITHOUT WRITTEN PERMISSION		DOCUMENT NO. SD-1545-*	SHEET NO. 2 OF 3			

PLUG	
PART NO.	ENG. NO.
03-09-2021	I545-P
03-09-2022	I545-P1
03-09-7021	I545-PBK
03-09-7022	I545-PIBK
03-09-2023	I545-P2
03-09-7024	I545-PIRD
03-09-7023	I545-PIBU
50-36-1686	I545-P1-1

RECEPTACLE	
PART NO.	ENG. NO.
03-09-6021	I545-R3BK
03-09-6023	I545-R3RD
03-09-6024	I545-R3BU
03-09-1022	I545-R1
03-09-1023	I545-R2
03-09-6025	I545-RIBU
03-09-1027	I545-R3
50-36-1685	I545-R1-1

LEGEND : PLUG

1545-P*****

OPTIONS: _____

BLANK = WITH STD. EARS
 1 = WITHOUT EARS
 2 = WITH PREBENT EARS

COLOR: BLANK=NATURAL COLOR _____

AM=AMBER BK=BLACK BU=BLUE
 BN=BROWN GY=GRAY GN=GREEN
 OR=ORANGE RD=RED YW=YELLOW

BLANK = MATERIAL CODE A _____
 1 = MATERIAL CODE B

LEGEND : RECEPTACLE

1545-R*****

BLANK = WITH STD. EARS & RAMPS _____
 1 = WITHOUT EARS, WITH RAMPS
 2 = WITHOUT EARS, WITHOUT RAMPS
 3 = WITH PREBENT EARS & RAMPS

COLOR: BLANK=NATURAL COLOR _____

AM=AMBER BK=BLACK BU=BLUE
 BN=BROWN GY=GRAY GN=GREEN
 OR=ORANGE RD=RED YW=YELLOW

BLANK = MATERIAL CODE A _____
 1 = MATERIAL CODE B

NOTES:

- MATERIAL: - A = NYLON, PA66, 94V-2. COLOR: SEE LEGEND.
 B = UL94V-0, PA6 NYLON, IEC 60335-1, 4TH EDITION GLOW WIRE CAPABLE.
- FINISH: NONE.
- PRODUCT SPECIFICATION: PS-02-09.
- PACKAGING INFORMATION: PK-1545-001
- .97/(24.6) REF. FOR TOOLS BUILT PRIOR TO FEB. 1985.
- 1.00/(25.4) REF. FOR TOOLS BUILT PRIOR TO FEB. 1985.
- RIBS ARE PRESENT ONLY ON PARTS WITH MOUNTING EARS.
- EACH TERMINAL POCKET WILL ACCEPT UP TO:
 (2) #18 AWG WIRES HAVING 1/32" THK. INSULATION OR
 (1) #16 AWG WIRE HAVING 1/16" THK. INSULATION OR
 (1) #16 AWG & (1) 18 AWG WIRE HAVING 1/32" THK. INSULATION .
- CIRCUIT I.D. NUMBERS ON SIDE OF HOUSING APPEAR ON PARTS FROM TOOLS BUILT AFTER 11/25/91.
- PARTS CONFORM TO CLASS 'B' REQUIREMENTS OF COSMETIC SPECIFICATION PS-45499-002 EXCEPT MATERIAL OPTION 'B' MEETS CLASS 'C' REQUIREMENTS FOR SINK AND DISCOLORATION.

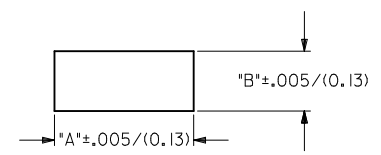
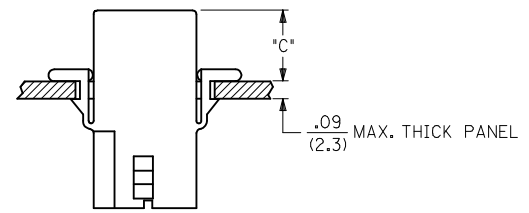

RECOMMENDED PANEL OPENING
(SCALE 2:1)

HOUSING	DIM. "A"	DIM. "B"	DIM. "C" (PREBENT)	DIM. "C" (STD. EAR)
PLUG	.800/(20.32)	.375/(9.53)	.40/(10.2)	.39/(9.9)
RECEPTACLE	.725/(18.42)	.312/(7.92)	.41/(10.4)	.40/(10.2)

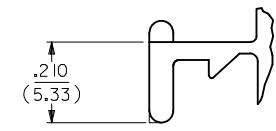

DETAIL 3

.093/(2.36) STANDARD MOUNTING EAR
(SCALE 4:1)

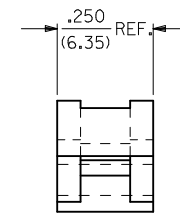

DETAIL 4

.093/(2.36) PREBENT MOUNTING EAR
(SCALE 4:1)

ADD MATL & P/N'S EC NO: UCP2007-2366 DR:WNAELHAG 2007/05/25 CHK:KLSCHMIDT 2007/06/01 APPR:FSMITH 2007/06/04 REV: V	QUALITY SYMBOLS ▽=0 ▽=0	GENERAL TOLERANCES (UNLESS SPECIFIED)		DIMENSION STYLE IN/MM	SCALE 2:1	DESIGN UNITS INCH	THIRD ANGLE PROJECTION		
		4 PLACES ± --- ± --- 3 PLACES ± --- ± .010 2 PLACES ± 0.25 ± .014 1 PLACE ± 0.35 ± ---	mm INCH ± .010 ± .014 ± 0.35 ± ---	DRAWN BY GEP	DATE 8/9/88	TITLE .093/(2.36) HOUSING, PLUG & RECEPTACLE, 2 CKT., .248/(6.30) CTR.			
		ANGULAR ± 1 °		CHECKED BY RW	DATE 8/9/88	MOLEX INCORPORATED			
		DRAFT WHERE APPLICABLE MUST REMAIN WITHIN DIMENSIONS		APPROVED BY RAS	DATE 8/9/88	MATERIAL NO. SEE CHART	DOCUMENT NO. SD-1545-*	SHEET NO. 3 OF 3	

THIS DRAWING CONTAINS INFORMATION THAT IS PROPRIETARY TO MOLEX INCORPORATED AND SHOULD NOT BE USED WITHOUT WRITTEN PERMISSION